



SAFETY, FACILITY AND EQUIPMENT  
**IDENTIFICATION**

[BradyID.com/s34](http://BradyID.com/s34)

**Celebrating 100 Years of Safety and Identification.**



# EXPERT SOLUTIONS BACKED BY 100 YEARS

It takes a lot to get it right. To be a company that lasts **100 years** by continually evolving and growing to meet the needs of our markets and customers. Brady has not only survived since it was founded in 1914 – **It has thrived.** Our first-to-the-market and best-in-the-market approach has led us to receive hundreds of patents over the years and truly shape an industry.

Simply put, **we do what others don't in ways they can't.** We offer innovative products backed by years of research and development. Beyond our quality products and reliable solutions, we add value to our customers through strong partnerships and a commitment to solving important problems.

Brady's products help customers increase safety, security, productivity and performance. Our offerings include high-performance labels, signs, safety devices, printing systems and software, as well as expert services.

A large, modern building with a grey, textured facade. The word 'BRADY' is prominently displayed in large, blue, three-dimensional letters on the side of the building. The building is set against a clear blue sky with some light clouds. In the foreground, there is a green lawn and some trees.

**LET US SHOW YOU  
WHAT WE HAVE  
TO OFFER.**

**[BradyID.com/s34](http://BradyID.com/s34)**

**NEW!**

With 100 years of experience, Brady continues to innovative with these new products!



**NEW!**

### NEW Printers

- BMP®21-PLUS Label Printer (Page 290)



**NEW!**

### NEW Signs

- ANSI Signs (Page 36)
- Assembly / Muster Signs (Page 98)



**NEW!**

### NEW Absorbents

- Barrier Backed Mats (Page 417)
- Adhesive Backed Rugs (Page 417)



**FREE Apps!**

### NEW App Based Software

- Brady WorkStation Apps (Page 404)

# TABLE OF CONTENTS

Key Business Issues.....	4
Safety Signs.....	22
Traffic Signs.....	171
Safety & Regulatory .....	200
Numbers & Letters .....	214
Labels & Tags .....	218
Valve Tags.....	240
Pipe Markers .....	246
Lean/Visual Workplace .....	262
Security .....	280
Dispensers .....	284
Portable Printers.....	288
Benchtop Printers .....	346
Software .....	404
Absorbents & Spill Control...410	
Lockout Tagout.....	438
Client Services .....	494
Sign Legend Index.....	498
Part Number Index.....	520

## Three Ways To Shop The Catalog Online!

- Scan the IOS or Android QR codes below
- Search the App Store for “Brady North America Catalogs”
- Access from the BradyID.com homepage



# Lean Manufacturing & Maintenance

BradyID.com/visualworkplace

## Visual Workplace

Visual Workplace - also known as Visual Factory or Visual Management – is a lean concept that emphasizes putting critical information at the point of use. Visual systems and devices play a critical role in many of the most popular lean tools, including 5S, Standard Work, Total Productive Maintenance, Quick Changeover, and Kanban (Pull Production).

### What info should I post?

If it's critical information, it should be embedded in your physical workplace. That means right where your employees work – on their equipment, on the shelves, on the floors... anywhere they can see it at a glance for "just-in-time communication."

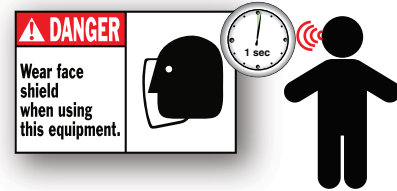

### What visuals should I use?

Signs, labels, placards, markers, displays... you name it! Visuals can be something as simple as a line, shape or color band – whatever employees can understand at a glance.

### Why is this so important?

#### The short answer:

Visuals make sure every employee knows exactly what to do, all the time. That means better safety, and better productivity!

#### The long answer:

# 50%

or more of a facility's activities are often considered waste! Waste is primarily caused because employees lack information. If you post the info where they need it... you cut the waste!



# 75%

Research shows that people learn 75% of what they know visually, 13% through hearing, and 12% through smell, touch, and taste. Workplace visuals play a HUGE role in job training.

# 78million



baby boomers are expected to retire over the next 10-15 years. Visuals help less experienced employees learn faster and work more efficiently.



### What are the benefits?

# 15% to 30%

Most companies see a 15-30% increase in productivity after effectively implementing a visual workplace.

#### Creates operational stability:

Visuals reinforce the standards you've put in place, and make sure abnormalities are quickly spotted – creating a base of operational stability for your facility.



#### Sustains continuous improvement:

Visuals are a key sustaining force in kaizen initiatives. They make sure improvements remain clearly visible, readily understood, and consistently adhered to... long after the kaizen or rapid improvement event is over!

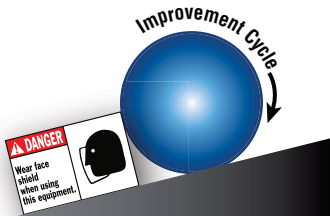

# Lean Manufacturing & Maintenance

BradyID.com/visualworkplace



## How Can Lean Visuals Help You?

Visual devices play an important role in many lean concepts, including 5S, Standard Work, Quick Changeover, and Just-In-Time Inventory Management. The photos below illustrate just a few of the many applications for using visuals in lean manufacturing.

### 5S Workplace Organization



### Standard Work



### Quick Changeover



### Kanban (Pull) Production



### Visual Management

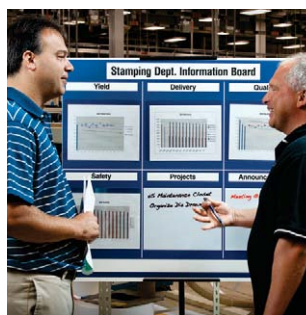

# Lean Manufacturing & Maintenance

BradyID.com/visualworkplace

## Equipment Reliability Made Visual

Lean manufacturers know that maintaining optimum equipment performance is critical, since they typically have less safety stock to rely on in the event of unexpected breakdowns. Equipment visuals such as those shown below are especially useful to those implementing autonomous, preventive and predictive maintenance programs.

**Incorporating visuals into your reliability program can provide important benefits:**

- Simplified operator-based care training
- Faster detection of operating abnormalities
- Quicker troubleshooting and root cause analysis
- Reduced stored inventory
- Fewer unplanned MRO purchases
- Improved safety and employee morale

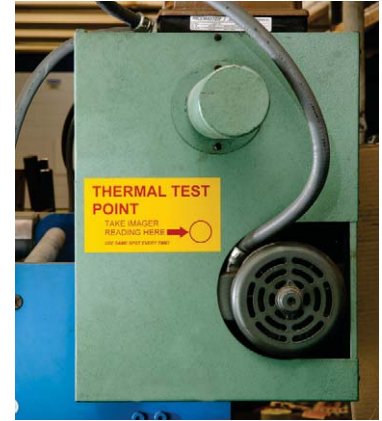

**Create labels like these with Brady's MarkWare™ Software and a Brady Label Printer**

### Lubrication

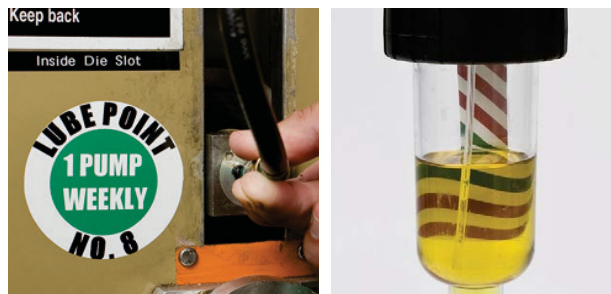

### Parts Management



### PM Inspection

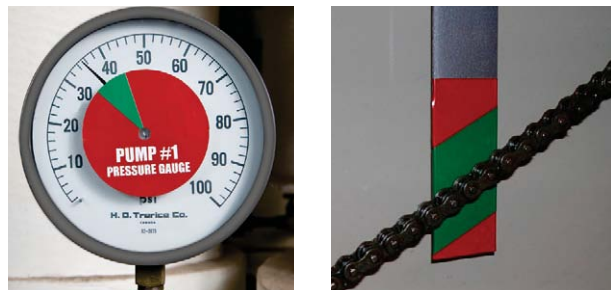

### Predictive Maintenance



### Equipment ID



**?** **Did you know?**  
**75% of learning is done through visuals**

Find out how you can increase employee knowledge, improve productivity and safety, and reduce waste all through the power of workplace visuals.

Download the guide:  
**BradyID.com/5Splusguide**

## Lean Manufacturing & Maintenance Product Solutions



### MarkWare™ Lean Tools Software (page 405)

MarkWare Lean Tools software provides versatile drawing tools and hundreds of premade templates that speed the design of signs, labels and tags used in lean production, maintenance / reliability, warehouse and safety applications.



### Sign & Label Printers (page 288)

Brady sign & label printers are essential tools for implementing a visual workplace, making it easy for you to create visuals onsite and on-demand.

- GlobalMark®2 Printer
- BBP®31 Label Printer
- BMP®71 Label Printer
- BMP®51 Label Printer
- BMP®41 Label Printer
- BMP®21-PLUS Label Printer



### ToughStripe® Floor Marking Tape (page 264)

Made with Brady's new B-514 polyester, ToughStripe products are ideal for marking aisles, passageways and storage locations, and pointing out important safety equipment and egress paths.



### Visual Workplace Shadow Boards (page 270)

Brady Shadow Boards use clear, professional-looking graphics to improve workplace organization and efficiency. With easily-identifiable storage locations, shift changes will become seamless as employees can quickly glance at the shadow board to identify what items are missing from their work area.



### 5S Marking Tapes (page 268)

Brady offers a wide range of products for marking floors, workbenches, tool boards and more. These products help to maintain order, identify hazards, and provide directional guidance.



### Absorbents & Spill Control (page 410)

A proper spill control program can create a safe and productive work environment. Brady SPC products provide for effective clean-up of spills and leaks throughout your facilities.

# Lockout Tagout

BradyID.com/lockouttagout

## Lockout Tagout: A Critical Safety Regulation

Lockout Tagout (LOTO) is an important safety procedure - critical to safeguarding workers and employees around the machinery and equipment they operate, service and maintain. It is also a major OSHA-inspection focus. In fact, it remains one of the most cited violations for general industry even after twenty years in force. Rather than focusing on the negative aspect of non-compliance and citations, focus instead on comprehensive and thoroughly-followed LOTO programs:

- **SAVE LIVES** – preventing an estimated 250,000 incidents, 50,000 injuries and 120 fatalities annually!
- **CUT COSTS** – significantly; both in lost employee time and insurance costs
- **IMPROVE PRODUCTIVITY** – minimizing equipment downtime
- **BEST PRACTICE** – being widely adopted across industries and industrialized countries

### Global leader in Lockout Tagout Solutions

Brady was first to respond to the new OSHA legislation in 1990, and has maintained its position as the leading lockout solutions provider ever since.

Today, Brady offers a comprehensive package for Lockout Tagout compliance combining services, regulatory expertise and unparalleled breadth and depth of product. Regardless of what stage you are at with your lockout tagout program, Brady can provide you with a custom solution.



### OSHA Regulation Summary:

OSHA 29 CFR §1910.147 The control of hazardous energy (Lockout Tagout).

#### (a) Scope, application and purpose

**(1) Scope.** (i) This standard covers the servicing and maintenance of machines and equipment in which the unexpected energization or start up of the machines or equipment, or release of stored energy, could harm employees. This standard establishes minimum performance requirements for the control of such hazardous energy.

**(2) Application.** (i) This standard applies to the control of energy during servicing and/or maintenance of machines and equipment.

**(3) Purpose.** (i) This section requires employers to establish a program and utilize procedures for affixing appropriate lockout devices or tagout devices to energy isolating devices, and to otherwise disable machines or equipment to prevent unexpected energization, start-up or release of stored energy in order to prevent injury to employees.

Top Sections Cited	Number of Violations
1910.147(c)(4) Requirements in energy control procedures	996
1910.147(c)(6) Requirements to periodically inspect the energy control procedure	653
1910.147(c)(1) Energy control program requirements	651
1910.147(c)(7) Training and communication requirements	580
1910.147(d)(4) Requirements for the application of Lockout Tagout devices	169

Data is reflective of OSHA's Fiscal Year 2013 (October 1, 2012 through September 30, 2013)



### Need Help? Let Brady's Field Engineers take care of all the details!

Brady's Lockout Tagout Procedure Writing Service is the most effective, stress-free way to create an OSHA-compliant lockout/tagout program. Brady's expert field technicians will come to your facility and :

- Evaluate your needs and equipment requirements
- Create visually-instructive procedures specific to your machinery, facility and employee safety requirements
- Laminate and install the new lockout tagout procedures
- Install color-coded energy source ID tags
- Collaborate with your team during the process and help you understand how to successfully maintain the program in-house

For more info, view page 494 or visit [BradyClientServices.com](http://BradyClientServices.com).





## 5 Steps To An Effective Lockout Program (page 438)



### Step 1: Develop Energy Control Policy/Program

The first step is to develop and document a lockout policy that identifies in detail the purpose and scope of your lockout program. It establishes the 'nuts and bolts' of your overall lockout program.



### Step 2: Machine-Specific Lockout Procedures

Per OSHA 29 CFR 1910.147(c)(4), detailed machine-specific procedures are required outlining scope, purpose, authorization, rules and techniques to be utilized for the control of hazardous energy. Visual lockout procedures provide clear, visually-intuitive instructions for employees to follow. Brady offers several options for creating these procedures:

- **LINK360® Cloud-Based Software**  
To manage, store and sustain machine safety and procedural information, LINK360 offers procedure creation, procedure maintenance, audit reminders and more.
- **Lockout/Tagout Procedure Writing Service**  
When utilizing Brady's Procedure Writing Services, you can rest assured that your procedures will be created and installed by industry experts who author over 26,000 procedures annually.



### Step 3: Identify Energy Control Points

The third step is to locate and mark all energy control points, including valves, switches, breakers and plugs, with permanently placed labels or tags.

- **Energy Control Point Signs, Tags and Labels**  
Brady has a full line of energy source identification products.
- **Industrial Label Printers**  
Create your energy source identification with Brady's make-it-yourself high performance printing systems.



### Step 4: Training, Communication & Inspections

Brady offers communication products that you can use to train your employees on lockout practices and procedures.

- **Safety Training & Awareness Aids**  
Brady offers handbooks, posters, labels, videos and DVD programs that you can use to train your employees.



### Step 5: Provide Proper Protective Products

Brady offers a comprehensive line of lockout devices including:

- **Safety Padlocks**
- **Personal & Group Lockout Kits**
- **Lockout Tags**
- **Wide variety of lockout devices for valves, plugs, circuit breakers, fuses and more**



### Learn More: Download the 5 Steps To An Effective Lockout Program Whitepaper

Download the full whitepaper today for more information and details on each one of these 5 steps.

Visit [BradyID.com/5steps](http://BradyID.com/5steps) to download the whitepaper.



# Arc Flash

BradyID.com/arcflash



## Comply with New Regulations, Increase Safety and Save Costs with Proper Identification.

There is a risk when working on live, energized electrical circuitry that can result in serious injury or death from a phenomenon known as Arc Flash. Arc Flash is a short circuit through the air that flashes between one live conductor to another conductor or to ground, causing a severe, explosive release of energy. It can be caused by a worker coming too close to a high-amp source with a conductive object, dropping a tool that makes contact with live components, breaks or gaps in wiring insulation or even poor maintenance practices. Arc Flash has the potential to generate extremely high heat, a forceful blast and intense light, caused by the rapid expansion of metallic components transforming to gas and molten particles in a fraction of a second. Experiencing an Arc Flash can cause severe injuries including loss of vision and hearing, third and fourth degree burns, along with the potential for severe electrical shock.



### OSHA Regulation Summary:

#### Section 5(a)(1) of the Occupational Safety and Health Act

The Occupational Safety and Health Administration, OSHA, has become more involved in the Arc Flash issue and has begun citing employers for failure to protect workers from the dangers of Arc Flash incidents. While no specific standard exists regulating Arc Flash, OSHA utilizes Section 5(a)(1) of the OSHA Act, often referred to as the General Duty Clause, by basing enforcement actions on an employer's duty to "furnish to each of his employees employment and a place of employment which are free from recognized hazards that are causing or are likely to cause death or serious physical harm..." To provide guidance on best practices for protecting employees from Arc Flash hazards, OSHA refers employers to the NFPA 70E Standard, "Standard for Electrical Safety in the Workplace."

#### NFPA70E 2012 - "Standard for Electrical Safety in the Workplace"

Article 110.16 in the NEC and Article 130.5 in NFPA 70E state that relevant electrical equipment shall be "field marked to warn qualified persons of potential electric arc flash hazards."

Once an arc flash hazard analysis has been conducted in which the arc flash boundary, the incident energy at the working distance, and the personal protective equipment required has been determined, Article 130.5 (C) in the 2012 edition of NFPA 70E further dictates that the label must contain these important elements:

#### 1. At least one of the following:

- a. Available incident energy and the corresponding working distance  
(An incident energy analysis is used to help predict the incident energy of an arc flash for a specified set of conditions. Incident energy is the amount of energy impressed on a surface, a certain distance away from the source, generated during an electrical arc event. This should be measured and labeled in cal/cm<sup>2</sup>.)  
**AND/OR**
- b. Minimum arc rating of clothing  
(This also should be expressed in cal/cm<sup>2</sup>. Arc rated clothing indicates it has been tested for exposure to an electrical arc. This was formally expressed as flame resistant in previous NFPA editions.)  
**AND/OR**
- c. Required Level of Personal Protection Equipment (PPE)  
**AND/OR**
- d. Highest Hazard/Risk Category (HRC) for the equipment

#### 2. Nominal System Voltage

A value assigned to a circuit or system for the purpose of conveniently designating its voltage class (i.e. a 12-volt battery, 24-volt system, or 480-volt electrical panel.)

#### 3. Arc Flash Boundary

### What Needs To Be Labeled, And By Whom?

The NEC states that any of the following types of electrical equipment located in manufacturing and commercial establishments (other than dwelling occupancies) must be field marked with a warning label if subject to examination, adjustment, service or maintenance while energized:

- Switchboards
- Panelboards
- Industrial control panels
- Meter socket enclosures
- Motor control centers

The labeling requirement is the responsibility of the employer, not the manufacturer or installer of the equipment.

## Arc Flash Product Solutions (page 218)



### Stock Labels

Brady provides a variety of stock labels that are designed to help you display the required information. The vinyl checkbox label shown here can be easily written on with pen or marker. An over-laminate can then be applied to protect the printing from harsh environmental conditions.

### Custom Arc Flash Labels

Brady will print complete custom arc flash labels to your specific labeling requirements. For additional information, visit: [BradyID.com/arcflash](http://BradyID.com/arcflash)

## Custom Arc Flash Labels Arc Flash Label Printing Systems

Brady's Make-it-Yourself printing systems and software features Brady's performance 300 or 600 dpi thermal transfer printers optimized to print Brady media and your Arc Flash labeling requirements. The printers are designed to be a convenient, flexible and cost-effective way to create, modify and print labels on demand.



### BBP<sup>®</sup>31 Sign & Label Printer

- 2-touch printing – just walk up and print!
- Prints labels from 1/2" to 4" wide
- Stand alone or PC-connect operation
- Large touch-screen display with "touch and drag" moving and sizing
- Wizard-style apps for pipe ID, arc flash, GHS labels, signs and tags

### High-Volume Labeling Solution - Bradyprinter™ PR Plus Printer

- Higher volume: up to 7,000 labels per day
- Heavier industrial environments
- Also ideal for rating plates, bar codes, general i.d., wire & cable marking, raised panel labels & more

### Mid-Volume Labeling Solution - IP™ Series Printer

- Medium volume: up to 5,000 labels per day
- Just load, click, print. It's that simple.
- Lighter manufacturing environments
- Ideal for rating plates, industrial bar codes, general i.d., wire & cable marking, raised panel labels

### TLS 2200<sup>®</sup> Portable Thermal Labeling System

- Print whatever, whenever.
- Auto label, size and text formatting
- Also ideal for printing bar codes, general i.d., wire & cable marking, raised panel labels



# Hazard Communication

BradyID.com/GHS

## Hazard Communication:

More than 40 million workers in the US may routinely come into contact with hazardous chemicals while performing their jobs.

In many cases, the chemicals are no more dangerous than those at home. But in the workplace, exposure is likely to be greater, concentrations higher, and exposure time longer.

Reactions to chemical exposures range from slight skin, eye, or respiratory irritation to life-threatening cancers, blood diseases, and debilitating lung damage.

OSHA developed the Hazard Communication Standard (HCS) to protect workers from these dangerous exposures. The standard is based on a simple concept – employees have both a need and a right to know about the hazards and identities of the chemicals they are exposed to, and what they can do to protect themselves.



## OSHA Regulation Summary:

### OSHA 29 CFR 1910.1200 Hazard Communication

**1910.1200(b)(1)** This section requires chemical manufacturers or importers to assess the hazards of chemicals which they produce or import, and all employers to provide information to their employees about the hazardous chemicals to which they are exposed, by means of a hazard communication program, labels and other forms of warning, material safety data sheets, and information and training. In addition, this section requires distributors to transmit the required information to employers.

**OSHA Focus** – HazCom is the most frequently cited violation for general industry, following Lockout Tagout

**Best Practice** – Recognized across many industries and markets

**Saves Lives** - The newly updated Hazard Communication Standard will prevent 500 injuries/illnesses and 43 fatalities annually.

**Cost Reductions & Productivity Improvements** – Future net benefits are estimated by OSHA to be \$556 million dollars per year.

## Hazard Communication Program in 5 Steps:

### 1. Develop a comprehensive written Hazard Communication plan.

This written plan outlines all of the sections of your organization's hazard communication program.

### 2. Inventory all chemicals.

Develop a process to identify and log all hazardous chemicals in a central site, including record keeping and updates.

### 3. Establish & maintain a comprehensive Safety Data Sheet (SDS) program.

All SDS's (previously known as Material Safety Data Sheets, or MSDS's) need to be collected and readily accessible to employees at all times on site.

### 4. Label all containers, pipes and tanks.

Primary containers, secondary containers and pipe and storage pipes containing hazardous chemicals must be labeled according to the applicable hazard communication regulations and company-established programs.

### 5. Train and communicate with your workforce.

All potentially affected employees must be fully trained according to the pertinent regulations and your hazard communication program.



Download the  
5 Steps to Hazard  
Communication Compliance  
Whitepaper at  
BradyID.com/GHS

## GHS (Globally Harmonized System) Compliance

GHS is an acronym for the The Globally Harmonized System of Classification and Labelling of Chemicals. The GHS standard is an international standard created by the United Nations for the purpose of classifying and labelling hazardous chemicals. A majority of countries globally have adopted and are enforcing most elements of the GHS with their regulatory agencies having jurisdiction for this public safety concern.

OSHA published an updated Hazard Communications standard in 2012 that incorporates the major elements of the GHS. A 3 year transitional period allows companies time to fully implement the new standards in their facilities.

### The basic requirements for OSHA's HazCom standard are:

- A written chemical hazard program
- Labels on containers
- Safety Data Sheets (SDS)
- Chemical hazard training for employees

### Implementation Timeline

Effective Date	Requirement(s)	Who
December 1, 2013	Train all employees on the new label elements and safety data sheet (SDS) format	Employers
June 1, 2015	Comply with all modified provisions of the final rule, except:	Chemical manufacturers, importers
December 1, 2015	Distributors must ship containers with a GHS label	Chemical distributors
June 1, 2016	Update workplace labeling and hazard communication program, and provide additional employee training if necessary	Employers

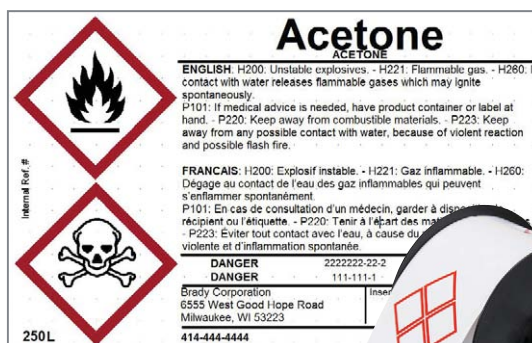

**?** **The Top 3 Things You Need To Know About GHS**

1. Label and SDS formats are changing, make sure your company and employees are trained and aware of the changes
2. This harmonized standard has already been adopted by 68 countries around the world (and that number is still growing)
3. Don't wait to take action! Start updating your labels and training your employees today

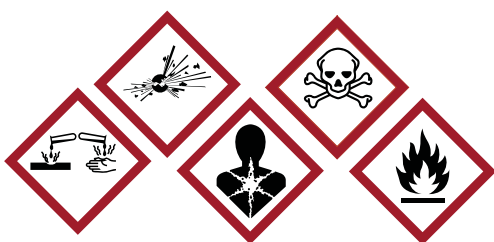

## GHS Compliance Product Solutions

### GHS Pictograms (page 200)

Pre-printed die cut labels identify hazardous products for chemical risks, health risks and environmental risks in accordance to the United Nations' universal approach to classifying and communicating chemical hazards.

### Label Printers & Software

#### BBP®31 and BBP®33 Label Printers (page 352)

Produce 2-color GHS labels in one print pass by using MarkWare™ Software and pre-printed GHS labels for the BBP®31 and BBP®33 Printers.

#### GlobalMark®2 Sign & Label Printer (page 380)

This multi-color benchtop printer has a built-in plotter cutter and can create labels up to 4" wide. It even prints directly on magnets and tag stock.

#### MarkWare™ Facility Identification Software (page 405)

Markware™ 3.9 Software facilitates the creation and printing of GHS-compliant labels. Includes templates for Brady's BBP®31 Sign & Label Printer, BBP®33 Label Printer, BBP®85 printer and GlobalMark®2 Industrial Printer.



# Slips / Trips / Falls

BradyID.com/slipstripsfalls

## 10 Steps to Preventing Slips, Trips & Falls in the Workplace

According to OSHA, "Slips, trips, and falls constitute the majority of general industry accidents. They cause 15% of all accidental deaths, and are second only to motor vehicles as a cause of fatalities."

### ? OSHA Regulation Summary:

The OSHA Walking and Working Surfaces Standard: Subpart D 29 CFR 1910.21-30 identifies requirements intended to minimize Slips, Trips and Falls in the workplace.

The OSHA standards for walking/working surfaces apply to all permanent places of employment, except where only domestic, mining, or agricultural work is performed.



### 1. Assess your needs

Brady Safety Assessments can help you identify and take corrective action before personal injuries occur.

### 2. Mark aisles and passageways

Brady's ToughStripe® Floor Marking Tape provides superior durability, easy application and high visibility.

Looking to provide signage at the point of need? Consider adding printed, high performance absorbents in your facility. These products combine safety-minded messaging with barrier backing for added durability - perfect for aisles and passageways!

### 3. Provide traction on slippery surfaces

Brady offers a variety of anti-skid floor tapes to provide traction throughout your facility including on steps and in entryways.

### 4. Improve safety on stairs

BradyGlo™ Anti-Skid Stairnosings products meet IBC, IFC and NFPA 2012 requirements for traction and visibility.

### 5. Mark emergency evacuation routes

Brady offers BradyGlo™ UL-listed EXIT signs, handrail covers and a variety of other glow-in-the-dark products for visibility in lights-out conditions.

# Slips / Trips / Falls

BradyID.com/slipstripsfalls



## 6. Post safety signage & labeling

Mark your facility with stock fall protection signs and floor marking signs, or make your own signs and labels with a Brady label maker.

## 7. Warn of temporary hazards

Mark temporary maintenance and janitorial hazards with Brady stands, barricade tapes, posts and chains.

## 8. Inspect scaffolds & ladders

Brady's Scafftag products provide system, procedure and legal compliance.

## 9. Control and clean oil & spills

Make sure your workroom floors are maintained in a clean and - so far as possible - dry condition with Brady SPC's Spill Containment & Clean-Up products.

## 10. Train your employees

Brady offers high-impact, interactive CD-ROM training to educate employees on slips, trips and falls prevention.

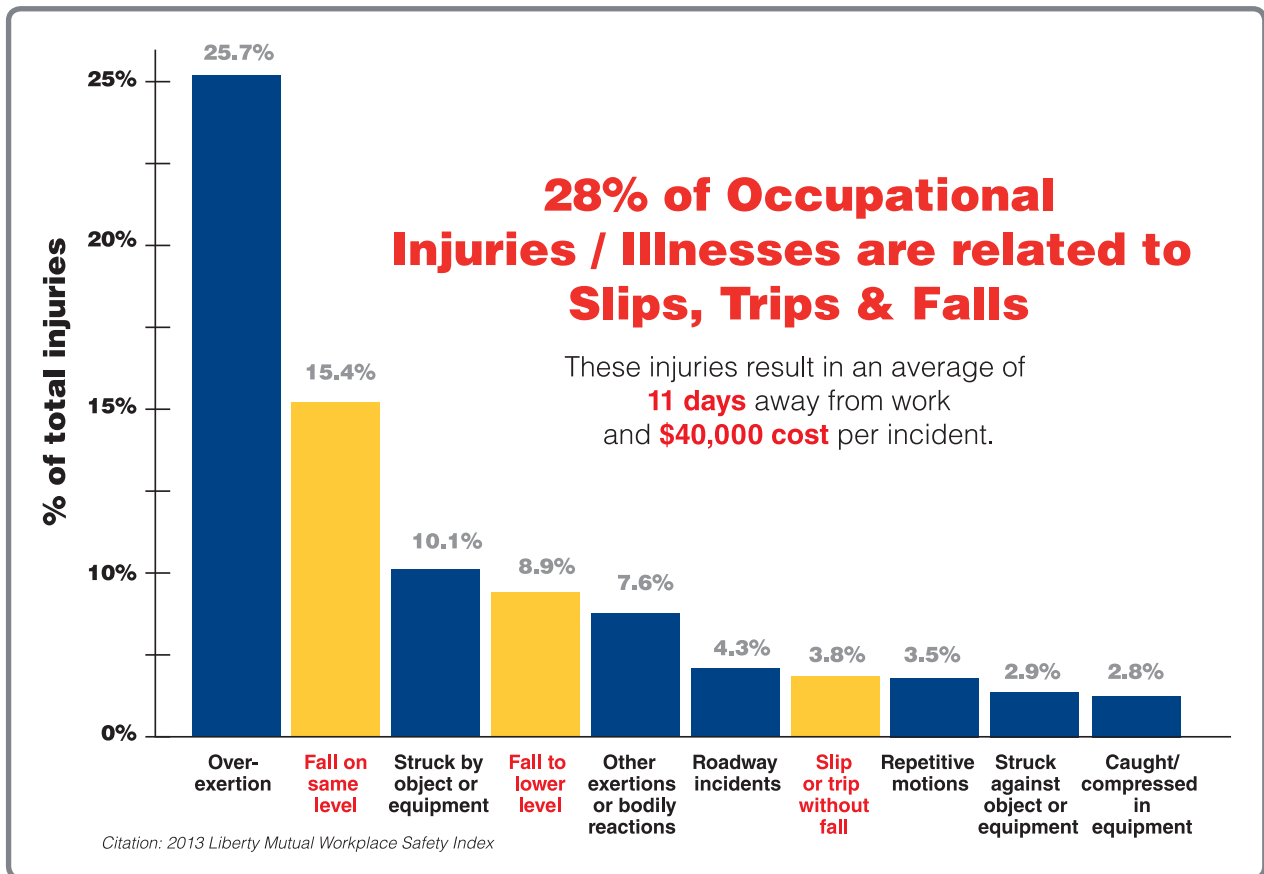

# Absorbents & Spill Control

BradyID.com/SPC



## A Better Way To Absorb Spills

Brady SPC offers an extensive line of polypropylene-based absorbent products for effective clean-up of spills and leaks throughout your facilities. These absorbents are specifically designed to effectively absorb most oils, coolants, solvents, chemicals and water-based fluids.

**Why choose a Brady SPC absorbent over traditional granular or clay products? Granulars have a number of shortfalls including:**

- **Cost** - they are significantly more expensive to dispose
- **Health Implications** - silica, an active ingredient in some granular products, is considered a health hazard by OSHA
- **Less Versatile** - granulars provide little chemical resistance
- **Messy** - clean up can be difficult
- **Dangerous** - loose granular can introduce a slip hazard to the environment
- **Damaging** - loose particulate can harm machinery



### OSHA and EPA Regulation Summary:

#### Regulated by OSHA:

- Clean, dry workplace floors [29 CFR 1910.22(a)(2)]
- DOT-specified containers and suitable quantities of absorbents shall be kept available for response to spills [29 CFR 1910.120(j)(1)(vii)]

#### Regulated by EPA:

- Sorbent materials are one option for preventing oil spills from reaching waterways EPA: [40 CFR 112.7(c)(1)(vii)]
- EPA requires you to control sources of storm water runoff EPA: [40 CFR 122.26]
- EPA requires transporters to clean up any hazardous waste discharge EPA: [40 CFR 263.31]



Clean up oil and petroleum-based spills on land or water with specialized sorbents that don't absorb water.

### Spill Prevention Control and Countermeasures Plan (SPCC):

The Spill Prevention Control and Countermeasures Plan (SPCC) is a comprehensive description of a facility's containment and countermeasures specifying both actions put in place to prevent an oil spill from occurring and procedures to respond if a spill does occur. Driven by the EPA's Federal Water Pollution Control Act (as amended by the Clean Water Act), this ruling is designed to prevent discharges of oil and oil-related materials from reaching navigable waters and adjoining shorelines.

#### The SPCC Plan consists of three parts:

1. Operating procedures that prevent oil spills
2. Control measures to prevent a spill from reaching the environment
3. Countermeasures to contain, clean up, and mitigate the effects of an oil spill that reaches the environment





## Choose the Right Absorbent (page 410)

Having the right absorbent for the job makes a big difference. Proper product selection can make your employee's jobs easier, create a safer work environment, and save you money!



### Your Spill:

- Coolants
- Solvents
- Gasoline
- Vegetable oil
- Kerosene
- Other water-based fluids

### Your Absorbent Solution:

#### Universal Absorbents

All-purpose products that clean-up oils, coolants, solvents and water-based fluids anywhere in your facility. Use around machinery, under leaky pipes, in messy traffic areas or for general maintenance projects. Re-Form™ universal absorbents made of recycled materials offer an environmentally friendly solution.



### Your Spill:

- Hydraulic oil
- Motor oil
- Brake fluid
- Cooking oil
- Turpentine
- Other oil-based fluids

### Your Absorbent Solution:

#### Oil Only Absorbents

Specialized for oil and other petroleum-based spills including paints and non-water soluble chemicals, these absorbents will not absorb water and will float indefinitely. Re-Form™ oil only absorbents made of recycled materials offer an environmentally friendly solution.



### Your Spill:

- Aggressive chemicals
- Citric acid
- Sodium hydroxide
- Other unknown chemicals

### Your Absorbent Solution:

#### Chemical Absorbents

Surfactant-treated polypropylene absorbents can be used on a wide range of chemicals, including hydrofluoric acid. They are chemically inert, so they will not react with aggressive fluids.



### Your Spill:

- Unexpected or large scale spills and leaks
- Critical accidents
- Indoor or outdoor drain applications
- Water or oil-based fluids

### Your Absorbent Solution:

#### Spill Control and Spill Kits

Be prepared for emergency spills with a variety of products conveniently bundled together - so you can be confident you have the products you need to contain unexpected spills.

Support your spill control program with other items including spill pallets, drain plugs and absorbent storage centers..



# Voice / Data Communications

BradyID.com/datacomm

## Immediate identification of wires, cables and assets is essential.

Faster identification of network assets in order to perform moves, adds, and changes to the network while minimizing the interruption of network services to the businesses IT serves.

Identification of cables and panels specifically in areas of telecommunications, electrical, and datacomm is directly connected to performance. The ability for professionals to map a cables path across connected components is important in reducing the time taken to troubleshoot and locate networking problems.



### ANSI/TIA/EIA 606 Standard Summary:

The standard specifies administration for a generic telecommunications cabling system that will support a multi-product, multi-vendor environment. It provides a uniform administration approach that is independent of applications, which may change several times throughout the life of the telecommunications infrastructure. It establishes guidelines for owners, end users, manufacturers, consultants, contractors, designers, installers and facilities administrators involved in the administration of the telecommunications infrastructure.

Use of this Standard is intended to increase the value of the system owner's investment in the infrastructure by reducing the labor expense of maintaining the system, extending the useful economic life of the system and providing effective service to users.



## An Integrated, Seamless Solution.

Brady is the only company to provide an integrated and seamless solution to assist customers with their need to identify, document, and manage their cable and network assets. Stop following a tangle of cables and easily document every aspect of the network, including horizontal and backbone cables, hardware, assets, pathways, locations, air blown fiber, data center racks, users and more.



## The Complete Voice / Data Comm Solution

### Printing Systems



**BMP®71 Label Printer**  
(page 324)

- Prints on more than 30 types of label materials and at speeds of 1.5 labels per second
- Ideal for wire and cable markers, rating plates, tags, marking racks, bays, frames, slots, and other voice/data equipment.



**BMP®51 Label Printer**  
(page 300)

- Prints on more than 20 material types and over 190 label parts
- Fast print speed of 1 inch per second
- Print labels from your Android phone - Download the free "Brady Mobile" App for instant access to quick and easy label making



**BMP®41 Label Printer**  
(page 294)

- Prints up to 250 labels per day at a print speed of 1.3" per second
- Wide range of materials so you can print all your jobs on one printer
- Built-in wizard-based applications and graphics to help create and print labels quickly and easily



**BMP®21-PLUS Label Printer**  
(page 290)

- Prints up 100 labels per day
- 70 total label parts, spanning 7 materials
- Tape widths 0.25" to 0.75"
- Automatic-label formatting for wire wraps, patch panels, terminal-blocks, cable flags, circuit breaker arrays and general banner labels

### Materials



Sleeves



Wrap-around

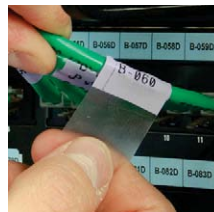

Self-Laminating



General ID



Flags / Tags



### Software (page 404)

#### LabelMark™ Labeling Software

LabelMark™ software allows you to easily format cable, faceplate and closet labels. The software includes templates for all the Brady labels designed for your application, and has built in templates to automatically format 110 block and patch panels.

#### NetDoc™ Network Documentation

NetDoc® Network Documentation and Cable Management Software provides you with the tools you need to manage cabling, network, telephone and legacy connections. NetDoc® allows you to easily document horizontal and backbone cables, hardware, assets, pathways, locations, users and much more!

### Services

Whether installing your software for the first time or maintaining an existing database, NetDoc Customer Support is available when needed. Our Support Specialists are committed to getting you the fast accurate answers you need in order to be successful.



# Emergency Egress and Exit Routes

BradyID.com/bradyglo

## Support a quick and safe exit of your building during an emergency

The events of 9/11 have led to a greater focus on exit route markings and safety. This has also led to the increasing use of photoluminescent signs and exit pathway markings. The main reason is that photolum signs continue to remain visible even in electrical "lights-out" conditions.



### ? 2015 International Building Code :

Luminous egress path markings shall be required in most new and existing buildings having occupied floors located more than 75 feet above fire department vehicle access:

- All steps shall have a solid and continuous stripe applied for the full length.
- All handrails shall be marked with a solid and continuous stripe for the entire length.
- Doors through which occupants must pass shall be provided with luminous markings complying with sections 1027.6.1 – 1027.6.3.
- Photoluminescent or other luminous UL 924 listed exit signs shall be installed in accordance with section 411.7 (exit marking).

### Regulated by OSHA: CFR 1910.33 – 39

- Every exit must be marked by a clearly visible sign with the word EXIT in plainly legible letters at least 6 inches high and with at least 3/4" stroke width.
- Exit signs shall be illuminated either by internal or external means by a "reliable" light source giving a value of not less than 5 foot-candles on the illuminated surface.
- When the way to an exit is not readily apparent, signs or markings similar to exit signs shall be provided which also provide directional information. Where arrows are used, they shall be obvious as to the direction of the exit.
- Any door, passage or stairway that is not an exit but looks as though it could be an exit must be marked with a sign reading "NOT AN EXIT".
- An emergency action plan must be in writing, kept in the workplace and available to employees for review.

### NFPA 101 The Life Safety Code

- An employer who is in compliance with the Life Safety Code is also deemed to be in compliance with the corresponding OSHA section requirements.

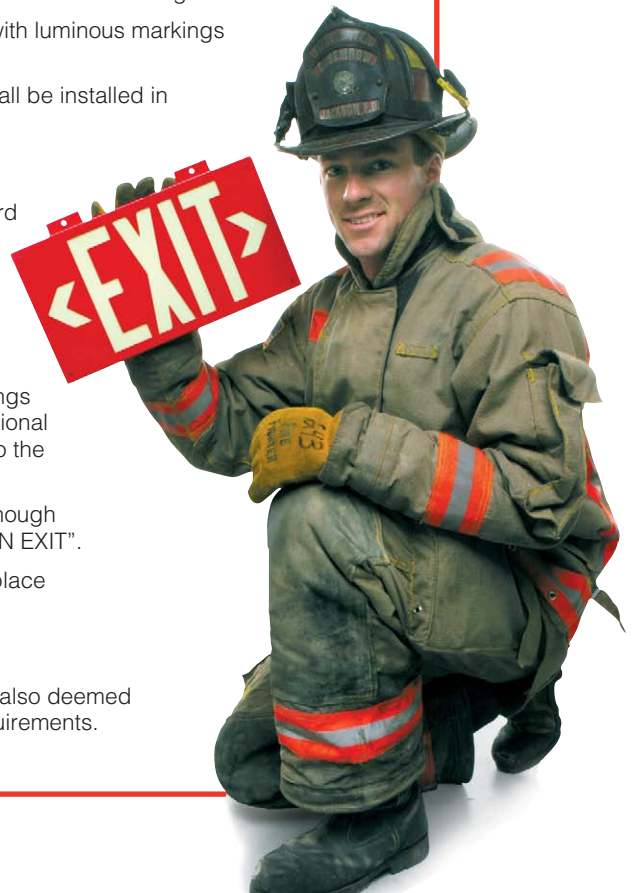

### Emergency Evacuation Marking

Clearly mark emergency evacuation routes and exits.



### Make Your Own Egress Signs

BBP®31 Sign & Label Printer features 2-touch printing and can print labels from 1/2" to 4" wide.



### Custom Glow Evacuation Maps

Print your evacuation maps on clear acetate and it glows in the dark. Contact Brady for more information.



## Food & Beverage Processing Facilities

Food safety is often a top priority for food processors. When this goal is met with the harsh washdown environment, you are forced to decide between maintaining a high level of food safety and implementing workplace safety, continuous improvement and compliance best practices.

With ToughWash® wash down resistant metal detectable signs, labels and tags, you no longer have to choose between food safety and a visually instructive workplace. You can confidently implement best practice solutions for workplace safety, compliance and continuous improvement while maintaining a strong food safety program.



### Workplace Safety:

In the food processing industry, safety hazards are around every corner. Whether it's slippery floors, chemical exposure, pinch points or industrial machinery maintenance, safety challenges are a constant presence.

However, concerns for food safety within harsh wash down environments prevent many food processors from properly identifying hazards on the processing floor.



### Compliance:

Government agencies and the Global Food Safety Initiative (GFSI) programs require food processors to have protocols and procedures in place for sanitation, critical control points, operating procedures and more.

As a result of the environment, food processors previously had to minimize signage on the production floor to ensure food safety. That means that protocols and procedures had to reside in binders on office shelves far away from the processing floor, where employees could seldom read them.



### Continuous Improvement:

The pressure to increase margins and improve yield continues to intensify with escalating costs of food commodities, energy and labor. In addition, product recalls and rework resulting from mix-ups on the processing floor can cost millions of dollars.

While a visual work environment can lead to a more efficient and productive workplace, food processors would often forego the use of visuals due to the food safety risk created by visuals in a wash down environment.

## Brady's Top Solutions For Food Processors



### 1. ToughWash™ Labels and Printer Systems

Wash down resistant, metal detectable labels stand up to harsh processing environments so you can create a safer, more productive visual work environment without compromising food safety.



### 2. ToughWash™ Signs and Tags

Wash down resistant, metal detectable encapsulated plastic signs and tags stand up to harsh processing environments so you can create a safer, more productive visual work environment with visual lockout procedures, sanitary operating procedures, critical control point procedures, inspection tags and more.



### 3. Lockout/Tagout Solutions

Visual lockout procedure writing services, lockout devices, and metal detectable VLOP placards & lockout tags create a best practice solution to ensure workplace safety for employees who disassemble machines for sanitation and maintenance.



# Safety Signs Selection Guide

BradyID.com/s34

## Safety Sign Selection Guide

Safety signs are a necessary and required component for warning and communicating messages or notices to your employees, customers and/or the general public. In order to provide a clear and concise message, the sign must meet a variety of requirements and standards. Selecting and placing a safety sign for your facility is more than a workplace requirement, but an opportunity to prevent costly accidents or dangerous hazards for individuals within your facility.



## Comply with Applicable Regulations

Check the specific sign requirements of the regulation you're complying with. Exit and fire extinguisher signs are covered by NFPA and IBC, general and chemical hazards by OSHA, traffic and parking signs by the Dept. of Transportation. Layout, text and signal words are covered by OSHA and ANSI. Below are several of the common regulations affecting signs:

Organization	What's Covered
<b>OSHA – Occupational Safety &amp; Health Administration</b>	OSHA 1910.37 Means of Egress, General (Exit signs and routes) OSHA 1910.144 Safety Color Code for Marking Physical Hazards OSHA 1910.145 Specifications for Accident Prevention Signs and Tags OSHA 1910.146 Permit-Required Confined Spaces OSHA 1910.147 Control of Hazardous Energy (Lockout/Tagout) OSHA 1910.1200 Hazard Communication (includes updated GHS standard) OSHA 1910.303 Electrical Subpart S; ((g)(2)(iii) and (h)(5)(iii)[B] – Warning Signs) OSHA 1926.200 Signs, Signals & Barricades for Construction
<b>DOT – Department of Transportation</b>	Hazardous Materials Warning Placards and Labels - Title 49, Code of Federal Regulations, Part 172 Subpart D–Marking, Subpart E – Labeling, Subpart F–Placarding - Title 49, Code of Federal Regulations, Parts 100-199 MUTCD 2009 with Revisions 1 & 2 (Manual on Uniform Traffic Control Devices) is the most current edition of the MUTCD
<b>NFPA – National Fire Protection Association</b>	NFPA 70: National Electrical Code NFPA 101: Life Safety Code NFPA 101B: Code for Means of Egress for Buildings and Structures NFPA 704: Standard System for the Identification of the Hazards of Materials for Emergency Response
<b>ICC – International Code Council</b>	IBC 2015 International Building Code IFC 2015 International Fire Code
<b>IMO – International Maritime Organization</b>	Resolution A.752(18) Egress and Low Level Lighting
<b>ANSI – American National Standards Institute</b>	ANSI Z535.1-2006(R2011), Safety Color Code ANSI Z535.2-2011, Environmental and Facility Safety Signs ANSI Z535.3-2011, Criteria for Safety Symbols ANSI Z535.4-2011, Product Safety Signs & Labels
<b>ISO – International Standards Organization</b>	ISO 7010:2011 Prescribes Safety Signs for the Purposes of Accident Prevention, Fire Protection, Health Hazard Information and Emergency Evacuation. ISO 7001:2007 Graphical Symbols, Public Information Symbols
<b>ADA – Americans with Disabilities Act</b>	2010 ADA Standards for Accessible Design; 703 Signs Meet Occupational Health Administration (OSHA 1910.145) and ANSI (ANSI Z535) regulations and guidelines.

**NEW!**

### New ANSI Sign Standard

Under OSHA's Hazard Communication Standard update, organizations can now use either the American National Standard Institute (ANSI) standards from 1967-1968 (ANSI Z53.1, Z35.1 & Z35.2) or from 2011 (ANSI Z535.1, Z535.2 & Z535.5) for safety signage.

OSHA's recent Consensus Standard updates the previous sign design by adding visual pictograms, a safety alert symbol in the header, upper and lower case text, and more explanatory text regarding the nature of the hazard, how to avoid the hazard, and consequences of not avoiding the hazard.

*A safety alert symbol needed for Danger, Warning and Caution signs*

*Text is succinct, active tense, left justified and follows character case rules*

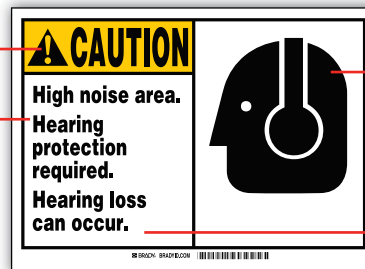

*Greater use of symbols and pictograms*

*Communicates hazard, consequence and avoidance statements*

## Display a Clear and Visible Message

### Safety Sign Headers (OSHA 1910.145 and ANSI Z535)

Messages such as “Warning” and “Caution” may seem synonymous, but they actually deliver very different messages. ANSI and OSHA specify that safety signs must indicate and define specific hazards that, without identification, may lead to accidental injury to workers, customers or the general public. The standard headers and definitions are listed below.

DANGER	WARNING	CAUTION	NOTICE	SAFETY
<ul style="list-style-type: none"> <li>Indicates an imminently hazardous situation which if not avoided, will result in death or serious injury.</li> <li>Limited to most extreme situations.</li> <li>Not used for property damage hazards unless personal injury risk to this level is also involved.</li> </ul>	<ul style="list-style-type: none"> <li>Indicates a potentially hazardous situation which, if not avoided, could result in death or serious injury.</li> <li>Not used for property damage hazards unless personal injury risk to this level is also involved.</li> <li>Appropriate for signs placed outside of the area or on the exterior of enclosures containing a Danger-level hazard.</li> </ul>	<ul style="list-style-type: none"> <li>Indicates a potentially hazardous situation which, if not avoided, may result in minor or moderate injury.</li> <li>May be used to alert against unsafe practices that may cause property damage.</li> </ul>	<ul style="list-style-type: none"> <li>Indicates a statement of company policy directly or indirectly related to the safety of personnel or protection of property.</li> <li>Should not be associated with a hazard or hazardous situation and shall not be used in place of DANGER, WARNING or CAUTION.</li> </ul>	<ul style="list-style-type: none"> <li>Indicate general instructions relative to safe work practices or indicate the location of safety equipment (e.g. eye wash station)</li> </ul>

### Safety Sign Letter Height (ANSI Z535.2-2011)

#### 9.2.2 Overall size of the lettering

The overall size of the lettering shall be determined by the distance from which the sign can be safely and easily read. The message should be concise as practical. Letters shall be adequately spaced and not crowded.

#### 9.2.3 Minimum letter height

Minimum letter height shall be one unit in height for every 150 units of safe viewing distance from the hazard alerting device for signal words and one unit in height for every 300 units viewing distance for the majority of other words contained on the word message panel. The safe viewing distance must be determined for each specific case where a safety sign is needed. The message panel text shall meet the legibility criteria at the determined safe viewing distance.

Viewing Distance	<4'	5'	8'	10'	15'	20'	30'	40'	60'	80'	100'	125'	150'	200'
Minimum Height for Favorable Reading Conditions	0.16" *	0.24"	0.32"	0.40"	0.60"	0.80"	1.20"	1.60"	2.40"	3.20"	4.00"	5.00"	6.00"	8.00"
Recommended Letter Height For Unfavorable Reading Conditions	0.33"	0.50"	0.66"	0.83"	1.27"	1.68"	2.51"	3.36"	5.04"	6.72"	8.40"	10.49"	12.58"	16.79"

\*0.16 inch (0.4 cm) type is the suggested minimum type size for use on environmental/facility safety signs.



# Safety Signs Selection Guide

BradyID.com/s34

## Choose the Right Material for Your Application

Choosing a material for your safety sign may not seem as significant as the message or regulatory compliance of the sign. But it's important to remember that different materials are equipped for different environments and applications. If you don't select the proper material, you could end up having to replace the sign more frequently than needed.



## Brady's Most Popular Sign Materials

### Rigid Signs

#### B-120 Premium Fiberglass

- Most durable, will not chip, fade, rust, shatter or peel for up to 25 years
- Graphics protected under fiberglass layer
- Excellent chemical & abrasion resistance
- Ideal for outdoor and harsh environments

#### B-401 Plastic

- Cost-effective durable polystyrene.
- Ideal for directional, informational, department and safety sign applications.
- Conforms to well-curved surfaces.
- Up to 5 year outdoor life

#### B-555 Aluminum

- Durable for indoor & outdoor usage
- Uses UV inks and UV clear coat protection for fade resistance
- Withstands wind, rain, sunlight and high temperatures
- 5-8 year outdoor life
- Used for parking, building and informational signs

### Flexible Signs (Adhesive Backed)

#### B-302 Self-Sticking Polyester

- Withstands wide temperature variations (up to 230F)
- Protected graphics holds up to repeated spills and cleanings
- Good for machine/equipment labels
- Permanent adhesive
- Up to 8 year outdoor life

#### B-946 Self-Sticking Durable Vinyl

- High gloss vinyl printed with UV resistant inks
- Permanent cold temp acrylic adhesive
- Good for outdoor applications on curved surfaces
- Fair chemical and abrasion resistance
- Durable, provides up to 10 years outdoor life.



### Eco-Friendly Sign Material Also Available

Eco-Friendly Safety Signs offer an alternative to traditional safety signs materials. Brady offers three different material options for eco-friendly signs:

#### B-586 Paper Signs

- Made of 10% post consumer waste
- Signs are 100% recyclable
- Suitable for indoor applications
- Stable, rigid paper material
- Material is 3.5mm thick
- Available for popular safety sign legends, in sizes 10"x14" and 7"x10"

#### B-563 Plastic Signs

- Made of 70% post consumer waste
- Can withstand outdoor conditions for 3-5 years
- Material is 0.55mm thick
- Available for popular safety sign legends, in sizes 10"x14" and 7"x10"

#### B-558 Pressure Sensitive Signs

- Made of 20% pre-consumer waste
- Material is 0.004 in. thick
- Recommended for indoor use
- Permanent adhesive backing
- Available for popular safety sign legends, in sizes 10"x14" and 7"x10"



# Safety Signs Selection Guide

BradyID.com/s34

## Sign Material Guide

Brady offers a sign material for virtually every application. Whether the sign is used indoors or outdoors, in mild or harsh environments, we have the material to match your application. Select the right sign for your application dependent upon the factors listed in the table below.

Material Type	Description	Protected Graphics	For Outdoor Use	Average Outdoor Durability	Chemical Resistance	Abrasion Resistance	Max. Temp	Thickness (in.)
<b>Flexible Sign Materials</b>								
Adhesive	B-302 High Performance Polyester	✓	✓	8 yrs	Excellent	Excellent	230° F (100°C)	.006-.010"
Adhesive	B-324 BradyGlo™ Photoluminescent Polyester	-	-	-	Good	Good	176°F (80°C)	.008"
Adhesive	B-485 Polyester Film	✓	-	-	Good	Good	122°F (50°C)	.011"
Adhesive	B-523 Photoluminescent Polyester Film with Aggressive Adhesive	-	-	-	Good	Good	176°F (80°C)	.0096"
Adhesive	B-534 Polyester Floor Sign with Anti-Skid Tread	✓	-	-	Good	Good	130°F (54°C)	.011"
Adhesive	B-808 BradyGlo™ Anti-Slip Polyester Floor Sign	✓	-	-	Good	Good	158°F (70°C)	.017"
Adhesive	B-819 Anti-Slip Vinyl Floor Sign	✓	-	-	Good	Good	158°F (70°C)	.012"
Adhesive	B-928 Write-On Vinyl with Cold Temp Adhesive	-	✓	2 yrs	Good	Good	176°F (80°C)	.005"
Adhesive	B-946 Self-Sticking Vinyl	-	✓	10 yrs	Fair	Good	180°F (82°C)	.004"
Adhesive	B-984 Photoluminescent Polyester Film	-	-	-	Good	Good	176°F (80°C)	.013"
Adhesive	B-997 BradyLite® Reflective Vinyl	-	✓	4-6 yrs	Good	Good	200°F (93°C)	.007"
Non-Adhesive	B-101 Polycoated Tagstock	-	-	-	Good	Good	158°F (70°C)	.010"
Non-Adhesive	B-586 Eco-Friendly Paperboard	-	-	-	Good	Good	175°F (80°C)	.060"
Non-Adhesive	B-811 Magnetic Vinyl	-	✓	2-4 yrs	Good	Good	158°F (70°C)	.025"
<b>Rigid Sign Materials</b>								
Metal	B-555 Aluminum	✓	✓	8 yrs	Excellent	Excellent	230°F (110°C)	.040-.090"
Metal	B-959 Reflective Aluminum	-	✓	4-8 yrs	Good	Good	175°F (80°C)	.040-.080"
Metal	B-986 Photoluminescent Polyester Film on Aluminum	-	-	-	Good	Good	175°F (80°C)	.049"
Metal	B-995 Diamond-Grade™ Reflective Aluminum	-	✓	7 yrs	Good	Good	212°F (100°C)	.097"
Fiberglass	B-120 Premium Fiberglass	✓	✓	25 yrs	Excellent	Excellent	193°F (90°C)	.100"
Fiberglass	B-140 Polyester on Fiberglass	✓	✓	8 yrs	Excellent	Excellent	175°F (79°C)	.070"
Fiberglass	B-320 Sub Surface Printed Lexan on Fiberglass	✓	✓	8 yrs	Good	Good	175°F (79°C)	.07"
Fiberglass	B-382 Sub Surface Printed Polycarbonate on Fiberglass	✓	✓	8 yrs	Good	Good	175°F (79°C)	.090"
Plastic	B-1 Thermoset Plastic	-	✓	8 yrs	Good	Good	193°F (89°C)	.062"
Plastic	B-347 BradyGlo™ Phosphorescent Polyester on Polystyrene	-	-	-	Good	Good	175°F (79°C)	.068"
Plastic	B-355 BradyGlo Steel Encased Photoluminescent Plastic	-	-	-	Good	Good	122°F (50°C)	.250"
Plastic	B-401 Polystyrene Plastic	✓	✓	5 yrs	Good	Good	175°F (79°C)	.060"
Plastic	B-450 Polyethylene Plastic	-	-	-	Good	Good	180°F (82°C)	.055"
Plastic	B-493 Plastic V-Shaped Signs	-	✓	2 yrs	Good	Good	193°F (90°C)	.100"
Plastic	B-563 Eco-Friendly Plastic (70% Post Consumer Waste)	-	✓	5 yrs	Good	Good	185°F (85°C)	.055"
Plastic	B-793 Polystyrene	-	✓	1-3 yrs	Poor	Good	165°F (74°C)	
Plastic	B-836 Temporary Sign Fluted Polypropylene	-	✓	1 yr	Good	Good	130°F (54°C)	.156"
Plastic	B-985 Photoluminescent Polyester Film on Polystyrene	-	-	-	Good	Good	175°F (80°C)	.069"



### Still Not Sure Which Material To Use? Request a Free Sample Pack!

- Each sample pack includes 3-1/2" x 5" material samples of some of Brady's best selling material including:
  - Premium Fiberglass
  - Fiberglass
  - Aluminum
  - Plastic
  - Polyester
  - Vinyl



# Safety Signs Selection Guide

BradyID.com/s34

## Sign Location

It is important to make certain that your sign will communicate the safety message to all of your employees, customers and the general public. The sign should be clear, concise and placed in a highly visible location. Placement of the sign is a key aspect in transmitting your message.

Keep the following tips in mind when placing your safety sign.

- Signs must be placed to alert and inform employees of hazards. They should have sufficient time to avoid the hazard and take appropriate action
- Signs must be clear, visible and unobstructed.
- Signs should be placed in an inert location. Signs should not be placed in moveable areas or near areas that could obstruct sign visibility such as doors or windows.
- Lighting, maintenance and storage should be considered during the placement process to make sure the sign can be clearly illuminated.

Safety signs should continue to be inspected, maintained and cleaned to ensure they are in good condition and in the appropriate location. If the message is no longer relevant or the hazard ceases to exist, the sign should be removed as soon as possible.



**Brady's Safety and Traffic Signs help keep your employees and visitors safe inside and outside your facility, in an emergency and in everyday actions.**



## CUSTOM SIGNS

**Brady's "Same as Stock" custom sign pricing makes it easy to create signs unique to your facility.**

Brady understands that sometimes you need a sign that is unique to your own facility. With Brady's wide variety of custom sign options, we have the ability to create a sign with exactly the message you need, in the material and size you want.

- Custom text
- Common sizes
- No minimum order
- Custom graphics
- Variety of materials
- Fast turnaround

**View page 194 for more information.**

## Safety & Traffic Signs Table Of Contents:

### Access & Directional Signs

Admittance .....	28
Door Signs.....	86
Evacuation / Assembly Point.....	98
Exit & Directional .....	91
IBC/IFC Compliant Exit Signs.....	96
Floor Signs.....	110
Hospital Signs .....	116
Restroom .....	159
Road Construction.....	171
Handicapped Parking .....	172
Rail.....	175
Traffic Control .....	176

### Emergency Signs

Fire Safety.....	100
First Aid .....	107

### General Communication Signs

Bilingual .....	50
Blank Signs .....	62
Braille.....	63
High Visibility Signs.....	113
Funny Sign.....	112
IMO Signs.....	99
Maintenance.....	132
Personal Hygiene .....	142
Personal Protection (PPE) .....	143
Recycle & Environment .....	158
Safety Banners .....	160
Safety Posters.....	163
Safety Slogan .....	165
Scoreboards.....	166
Security.....	167
Temporary Signs .....	170

### Safety Sign Sliders ..... 188

### Hazard Identification

ANSI Z535 .....	36
Biohazard .....	61
Chemical & Hazardous Material..	64
Confined Space.....	82
Construction Site .....	85
DOT Placards.....	79
Electrical Hazard .....	88
Lockout/Tagout.....	118
Machine & Operational.....	120
Radiation & Laser .....	25

### Prohibited Items

No Cellular Phones.....	135
No Smoking.....	136
No Firearms / Weapons.....	34

### Sign Legend Index..... 498

## View Stock Signs

Within each application section above, signs are arranged alphabetically by header, and then by legend text.

### Example Listing:



124745	7" x 10"	SS
124748	10" x 14"	SS
124744	7" x 10"	PL
124747	10" x 14"	PL
124743	7" x 10"	AL
124746	10" x 14"	AL

**Catalog #    Size    Material**

## Can't Find Your Sign?

- 1) Use the Sign Legend Index** (page 498)  
Use the index to quickly and easily locate the page number for a specific stock sign legend.
- 2) View on BradyID.com**  
View Brady's wide variety of signs for safety, maintenance and facility identification online.
- 3) Customize it!** (page 194)  
With **"same-as-stock"** custom sign pricing, you can create any sign you need for the same price as a stock part!



# Admittance Signs

BradyID.com/s34

## Admittance Signs

Brady admittance signs indicate and identify areas of access that are required in virtually every workplace. They alert employees to potential hazards, safety warning, and cautionary notices. They also restrict access to property and are available in a variety of sizes and materials.

### Popular Sign Materials

- FB** - Premium Fiberglass (B-120)
- SS** - Self-Sticking Polyester (B-302)
- BGSS** - BradyGlo™ Self-Sticking Polyester (B-324)
- BGPL** - BradyGlo™ Plastic (B-347)
- PL** - Plastic (B-401)
- AL** - Aluminum (B-555)

View all sign materials on page 25.

### Can't find your sign?

Use the Sign Legend Index on page 498 or take advantage of our custom sign options.

Safety Signs

<p><b>CAUTION</b></p> <p>ALARM WILL SOUND IF DOOR OPENS</p>	<p><b>CAUTION</b></p> <p>APPROACH DOOR SLOWLY</p>	<p><b>CAUTION</b></p> <p>AUTHORIZED PERSONNEL ONLY</p>	<p><b>CAUTION</b></p> <p>BEFORE ENTERING, TEST FOR EXPLOSIVE ATMOSPHERE TEST FOR OXYGEN DEFICIENCY SUPPLY FRESH AIR TO WORK AREA</p>	<p><b>CAUTION</b></p> <p>CONFINED SPACE NO. _____ ENTRY PERMIT REQUIRED CALL _____</p>	<p><b>CAUTION</b></p> <p>CONSTRUCTION AREA AUTHORIZED PERSONNEL ONLY</p>
124649 7' x 10' SS 124652 10' x 14' SS 124648 7' x 10' PL 124651 10' x 14' PL 124647 7' x 10' AL 124650 10' x 14' AL	124655 7' x 10' SS 124658 10' x 14' SS 124654 7' x 10' PL 124657 10' x 14' PL 124653 7' x 10' AL 124656 10' x 14' AL	95329 7' x 10' FB 95333 10' x 14' FB 95326 7' x 10' SS 95330 10' x 14' SS 95327 7' x 10' PL 95332 10' x 14' PL 95328 7' x 10' AL 95331 10' x 14' AL	84002 7' x 10' SS 84003 10' x 14' SS 22053 7' x 10' PL 22054 10' x 14' PL 40617 7' x 10' AL 40618 10' x 14' AL	84006 7' x 10' SS 84007 10' x 14' SS 40621 7' x 10' AL 40622 10' x 14' AL	95341 10' x 14' FB 95338 10' x 14' SS 95335 7' x 10' PL 95340 10' x 14' PL 95339 10' x 14' AL
<p><b>CAUTION</b></p> <p>DO NOT ENTER</p>	<p><b>CAUTION</b></p> <p>DO NOT ENTER WHEN LIGHT IS ON</p>	<p><b>CAUTION</b></p> <p>DO NOT ENTER WHILE MACHINERY IN MOTION</p>	<p><b>CAUTION</b></p> <p>DO NOT ENTER WITHOUT A CONFINED SPACE PERMIT</p>	<p><b>CAUTION</b></p> <p>DO NOT ENTER WITHOUT WEARING EYE AND EAR PROTECTION</p>	<p><b>CAUTION</b></p> <p>DO NOT OPEN ALARM WILL SOUND</p>
75444 7' x 10' FB 47093 10' x 14' FB 84008 7' x 10' SS 84009 10' x 14' SS 22059 7' x 10' PL 22060 10' x 14' PL 40623 7' x 10' AL 40624 10' x 14' AL	124667 7' x 10' SS 124670 10' x 14' SS 124666 7' x 10' PL 124669 10' x 14' PL 124665 7' x 10' AL 124668 10' x 14' AL	69102 10' x 14' FB 84010 7' x 10' SS 84011 10' x 14' SS 22061 7' x 10' PL 22062 10' x 14' PL 40625 7' x 10' AL 40626 10' x 14' AL	69103 10' x 14' FB 84012 7' x 10' SS 84013 10' x 14' SS 22063 7' x 10' PL 22064 10' x 14' PL 40627 7' x 10' AL 40628 10' x 14' AL	69106 10' x 14' FB 84014 7' x 10' SS 84015 10' x 14' SS 22065 7' x 10' PL 22066 10' x 14' PL 40629 7' x 10' AL 40630 10' x 14' AL	124661 7' x 10' SS 124664 10' x 14' SS 124660 7' x 10' PL 124663 10' x 14' PL 124659 7' x 10' AL 124662 10' x 14' AL
<p><b>CAUTION</b></p> <p>DOOR OPENS OUTWARD</p>	<p><b>CAUTION</b></p> <p>EMPLOYEES ONLY</p>	<p><b>CAUTION</b></p> <p>ENTRY PROHIBITED WITHOUT PERMIT TEST FOR O<sub>2</sub> DEFICIENCY, H<sub>2</sub>S AND COMBUSTIBLE VAPORS</p>	<p><b>CAUTION</b></p> <p>HAZARDOUS AREA AUTHORIZED PERSONNEL ONLY</p>	<p><b>CAUTION</b></p> <p>KEEP AWAY</p>	<p><b>CAUTION</b></p> <p>KEEP OUT</p>
124673 7' x 10' SS 124676 10' x 14' SS 124672 7' x 10' PL 124675 10' x 14' PL 124671 7' x 10' AL 124674 10' x 14' AL	124679 7' x 10' SS 124682 10' x 14' SS 124678 7' x 10' PL 124681 10' x 14' PL 124677 7' x 10' AL 124680 10' x 14' AL	84018 7' x 10' SS 84019 10' x 14' SS 22067 7' x 10' PL 40631 7' x 10' AL 40632 10' x 14' AL	124685 7' x 10' SS 124688 10' x 14' SS 124684 7' x 10' PL 124687 10' x 14' PL 124683 7' x 10' AL 124686 10' x 14' AL	124697 7' x 10' SS 124700 10' x 14' SS 124696 7' x 10' PL 124699 10' x 14' PL 124695 7' x 10' AL 124698 10' x 14' AL	124691 7' x 10' SS 124694 10' x 14' SS 124690 7' x 10' PL 124693 10' x 14' PL 124689 7' x 10' AL 124692 10' x 14' AL
<p><b>CAUTION</b></p> <p>NO TRESPASSING</p>	<p><b>CAUTION</b></p> <p>RESTRICTED AREA</p>	<p><b>CAUTION</b></p> <p>ROBOT OPERATING AREA DO NOT ENTER AUTHORIZED PERSONS ONLY</p>	<p><b>CAUTION</b></p> <p>STAY CLEAR</p>	<p><b>CAUTION</b></p> <p>THESE DOORS CLOSE AUTOMATICALLY</p>	<p><b>CAUTION</b></p> <p>THIS AREA CLOSED OFF</p>
124703 7' x 10' SS 124706 10' x 14' SS 124702 7' x 10' PL 124705 10' x 14' PL 124701 7' x 10' AL 124704 10' x 14' AL	95345 7' x 10' FB 95349 10' x 14' FB 95346 10' x 14' SS 95343 7' x 10' PL 95348 10' x 14' PL 95344 7' x 10' AL 95347 10' x 14' AL	73472 14' x 20' FB 84026 7' x 10' SS 84027 10' x 14' SS 22069 7' x 10' PL 22070 10' x 14' PL 40633 7' x 10' AL	124709 7' x 10' SS 124712 10' x 14' SS 124708 7' x 10' PL 124711 10' x 14' PL 124707 7' x 10' AL 124710 10' x 14' AL	124715 7' x 10' SS 124718 10' x 14' SS 124714 7' x 10' PL 124717 10' x 14' PL 124713 7' x 10' AL 124716 10' x 14' AL	124721 7' x 10' SS 124724 10' x 14' SS 124720 7' x 10' PL 124723 10' x 14' PL 124719 7' x 10' AL 124722 10' x 14' AL

## Admittance Signs (Continued)



124727	7" x 10"	SS
124730	10" x 14"	SS
124726	7" x 10"	PL
124729	10" x 14"	PL
124725	7" x 10"	AL
124728	10" x 14"	AL



124733	7" x 10"	SS
124736	10" x 14"	SS
124732	7" x 10"	PL
124735	10" x 14"	PL
124731	7" x 10"	AL
124734	10" x 14"	AL



70820	10" x 14"	FB
84032	7" x 10"	SS
84033	10" x 14"	SS
22071	7" x 10"	PL
22072	10" x 14"	PL
40635	7" x 10"	AL
40636	10" x 14"	AL



84034	7" x 10"	SS
84035	10" x 14"	SS
22074	10" x 14"	PL
40637	7" x 10"	AL
40638	10" x 14"	AL



95369	7" x 10"	FB
95373	10" x 14"	FB
95366	7" x 10"	SS
95370	10" x 14"	SS
95367	7" x 10"	PL
95372	10" x 14"	PL
95368	7" x 10"	AL
95371	10" x 14"	AL



131637	7" x 10"	FB
131638	10" x 14"	FB
131635	7" x 10"	SS
131636	10" x 14"	SS
131633	7" x 10"	PL
131634	10" x 14"	PL
131631	7" x 10"	AL
131632	10" x 14"	AL



95396	7" x 10"	FB
95400	10" x 14"	FB
95393	7" x 10"	SS
95397	10" x 14"	SS
95394	7" x 10"	PL
95399	10" x 14"	PL
95395	7" x 10"	AL
95398	10" x 14"	AL



131645	7" x 10"	FB
131646	10" x 14"	FB
131643	7" x 10"	SS
131644	10" x 14"	SS
131641	7" x 10"	PL
131642	10" x 14"	PL
131639	7" x 10"	AL
131640	10" x 14"	AL



70852	14" x 20"	FB
84036	7" x 10"	SS
84037	10" x 14"	SS
22075	7" x 10"	PL
22076	10" x 14"	PL
40639	7" x 10"	AL
40640	10" x 14"	AL



69771	10" x 14"	FB
84038	7" x 10"	SS
84039	10" x 14"	SS
22077	7" x 10"	PL
22078	10" x 14"	PL
40641	7" x 10"	AL
40642	10" x 14"	AL



84042	7" x 10"	SS
84043	10" x 14"	SS
22079	7" x 10"	PL
22080	10" x 14"	PL
40643	7" x 10"	AL
40644	10" x 14"	AL



70250	20" x 14"	FB
84566	14" x 10"	SS



70252	20" x 14"	FB
84569	10" x 7"	SS
84570	14" x 10"	SS
22432	14" x 10"	PL



73451	10" x 14"	FB
95401	7" x 10"	SS
60571	10" x 14"	SS
25804	10" x 14"	PL
43381	10" x 14"	AL



124745	7" x 10"	SS
124748	10" x 14"	SS
124744	7" x 10"	PL
124747	10" x 14"	PL
124743	7" x 10"	AL
124746	10" x 14"	AL



70885	7" x 10"	FB
122714	10" x 14"	FB
87750	3-1/2" x 5"	SS
84571	7" x 10"	SS
84572	10" x 14"	SS
22433	7" x 10"	PL
22434	10" x 14"	PL
40997	7" x 10"	AL
40998	10" x 14"	AL



69109	7" x 17"	FB
-------	----------	----



131621	7" x 10"	FB
131622	10" x 14"	FB
131619	7" x 10"	SS
131620	10" x 14"	SS
131617	7" x 10"	PL
131618	10" x 14"	PL
131615	7" x 10"	AL
131616	10" x 14"	AL



69097	10" x 14"	FB
84054	7" x 10"	SS
84055	10" x 14"	SS
22082	10" x 14"	PL
40645	7" x 10"	AL
40646	10" x 14"	AL



69111	10" x 14"	FB
84056	7" x 10"	SS
84057	10" x 14"	SS
22083	7" x 10"	PL
22084	10" x 14"	PL
40647	7" x 10"	AL



123619	7" x 10"	SS
123622	10" x 14"	SS
123618	7" x 10"	PL
123621	10" x 14"	PL
123617	7" x 10"	AL
123620	10" x 14"	AL



124757	7" x 10"	SS
124760	10" x 14"	SS
124756	7" x 10"	PL
124759	10" x 14"	PL
124755	7" x 10"	AL
124758	10" x 14"	AL



69101	10" x 14"	FB
84060	7" x 10"	SS
84061	10" x 14"	SS
22086	10" x 14"	PL
40649	7" x 10"	AL
40650	10" x 14"	AL



124739	7" x 10"	SS
124742	10" x 14"	SS
124738	7" x 10"	PL
124741	10" x 14"	PL
124737	7" x 10"	AL
124740	10" x 14"	AL



69105	10" x 14"	FB
84062	7" x 10"	SS
84063	10" x 14"	SS
22087	7" x 10"	PL
22088	10" x 14"	PL



69108	10" x 14"	FB
84064	7" x 10"	SS
84065	10" x 14"	SS
22089	7" x 10"	PL
22090	10" x 14"	PL
40654	10" x 14"	AL



124763	7" x 10"	SS
124766	10" x 14"	SS
124762	7" x 10"	PL
124765	10" x 14"	PL
124761	7" x 10"	AL
124764	10" x 14"	AL



# Admittance Signs

BradyID.com/s34

## Admittance Signs (Continued)



- 71543 7" x 10" FB
- 71545 10" x 14" FB
- 87754 3-1/2" x 5" SS
- 84068 7" x 10" SS
- 84069 10" x 14" SS
- 22093 7" x 10" PL
- 22094 10" x 14" PL
- 40657 7" x 10" AL
- 40658 10" x 14" AL



- 131721 7" x 10" FB
- 131722 10" x 14" FB
- 131719 7" x 10" SS
- 131720 10" x 14" SS
- 131717 7" x 10" PL
- 131718 10" x 14" PL
- 131715 7" x 10" AL
- 131716 10" x 14" AL



- 95357 7" x 10" FB
- 69193 10" x 14" FB
- 87755 3-1/2" x 5" SS
- 84066 7" x 10" SS
- 84067 10" x 14" SS
- 22091 7" x 10" PL
- 22092 10" x 14" PL
- 40655 7" x 10" AL
- 40656 10" x 14" AL



- 124769 7" x 10" SS
- 124772 10" x 14" SS
- 124768 7" x 10" PL
- 124771 10" x 14" PL
- 124767 7" x 10" AL
- 124770 10" x 14" AL

**Popular Sign Materials**

**FB** - Premium Fiberglass (B-120)  
**SS** - Self-Sticking Polyester (B-302)  
**BGSS** - BradyGlo™ Self-Sticking Polyester (B-324)  
**BGPL** - BradyGlo™ Plastic (B-347)  
**PL** - Plastic (B-401)  
**AL** - Aluminum (B-555)

*View all sign materials on page 25.*

**Can't find your sign?**  
*Use the Sign Legend Index on page 498 or take advantage of our custom sign options.*



- 124751 7" x 10" SS
- 124754 10" x 14" SS
- 124750 7" x 10" PL
- 124753 10" x 14" PL
- 124749 7" x 10" AL
- 124752 10" x 14" AL



- 70330 10" x 14" FB
- 85174 10" x 14" SS
- 25659 10" x 14" PL
- 43236 10" x 14" AL



- 124775 7" x 10" SS
- 124778 10" x 14" SS
- 124774 7" x 10" PL
- 124777 10" x 14" PL
- 124773 7" x 10" AL
- 124776 10" x 14" AL



- 69273 10" x 14" FB
- 22097 7" x 10" PL
- 22098 10" x 14" PL
- 40661 7" x 10" AL
- 40662 10" x 14" AL



- 95407 10" x 14" FB
- 70371 14" x 20" FB
- 84074 7" x 10" SS
- 84075 10" x 14" SS
- 22099 7" x 10" PL
- 22100 10" x 14" PL
- 40663 7" x 10" AL
- 40664 10" x 14" AL



- 70375 10" x 14" FB
- 84080 7" x 10" SS
- 84081 10" x 14" SS
- 22101 7" x 10" PL
- 22102 10" x 14" PL
- 40665 7" x 10" AL
- 40666 10" x 14" AL



- 45470 7" x 10" FB
- 45471 10" x 14" FB
- 45472 14" x 20" FB
- 89174 3-1/4" x 4-1/2" SS
- 84082 3-1/2" x 5" SS
- 84083 7" x 10" SS
- 84084 10" x 14" SS
- 22103 7" x 10" PL
- 22104 10" x 14" PL
- 40667 7" x 10" AL
- 40668 10" x 14" AL



- 131661 7" x 10" FB
- 131662 10" x 14" FB
- 131659 7" x 10" SS
- 131660 10" x 14" SS
- 131657 7" x 10" PL
- 131658 10" x 14" PL
- 131655 7" x 10" AL



- 122894 7" x 10" FB
- 122756 10" x 14" FB
- 71580 14" x 20" FB
- 87751 3-1/2" x 5" SS
- 84085 7" x 10" SS
- 84086 10" x 14" SS
- 22105 7" x 10" PL
- 22106 10" x 14" PL
- 40669 7" x 10" AL
- 40670 10" x 14" AL



- 47006 10" x 14" FB
- 84089 7" x 10" SS
- 84090 10" x 14" SS
- 40671 7" x 10" AL
- 40672 10" x 14" AL



- 124781 7" x 10" SS
- 124784 10" x 14" SS
- 124780 10" x 14" PL
- 124783 10" x 14" PL
- 124779 7" x 10" AL
- 124782 10" x 14" AL



- 124787 7" x 10" SS
- 124790 10" x 14" SS
- 124786 7" x 10" PL
- 124789 10" x 14" PL
- 124785 7" x 10" AL
- 124788 10" x 14" AL



- 47152 7" x 10" FB
- 84091 7" x 10" SS
- 84092 10" x 14" SS
- 22109 7" x 10" PL
- 22110 10" x 14" PL
- 40673 7" x 10" AL
- 40674 10" x 14" AL



- 124793 7" x 10" SS
- 124796 10" x 14" SS
- 124792 7" x 10" PL
- 124795 10" x 14" PL
- 124791 7" x 10" AL
- 124794 10" x 14" AL



- 95356 7" x 10" FB
- 75478 14" x 20" FB
- 47008 10" x 14" FB
- 87759 3-1/2" x 5" SS
- 84095 7" x 10" SS
- 84096 10" x 14" SS
- 22111 7" x 10" PL
- 22112 10" x 14" PL
- 40675 7" x 10" AL
- 40676 10" x 14" AL



- 131653 7" x 10" FB
- 131654 10" x 14" FB
- 131651 7" x 10" SS
- 131652 10" x 14" SS
- 131649 7" x 10" PL
- 131650 10" x 14" PL
- 131647 7" x 10" AL
- 131648 10" x 14" AL



- 73430 14" x 20" FB
- 84097 7" x 10" SS
- 22113 7" x 10" PL
- 22114 10" x 14" PL
- 40677 7" x 10" AL
- 40678 10" x 14" AL



- 123721 7" x 10" SS
- 123724 10" x 14" SS
- 123720 7" x 10" PL
- 123723 10" x 14" PL
- 123719 7" x 10" AL
- 123722 10" x 14" AL



- 84101 7" x 10" SS
- 22115 7" x 10" PL
- 22116 10" x 14" PL
- 40679 7" x 10" AL
- 40680 10" x 14" AL



- 124799 7" x 10" SS
- 124802 10" x 14" SS
- 124798 7" x 10" PL
- 124801 10" x 14" PL
- 124797 7" x 10" AL
- 124800 10" x 14" AL



- 95392 10" x 14" FB
- 95389 10" x 14" SS
- 95391 10" x 14" PL
- 95390 10" x 14" AL



- 95361 7" x 10" FB
- 95365 10" x 14" FB
- 132057 7" x 10" SS
- 95362 10" x 14" SS
- 95359 7" x 10" PL
- 95364 10" x 14" PL
- 95360 7" x 10" AL
- 95363 10" x 14" AL



- 123703 10" x 7" SS
- 123706 14" x 10" SS
- 123702 10" x 7" PL
- 123705 14" x 10" PL
- 123701 10" x 7" AL
- 123704 14" x 10" AL



- 70456 7" x 17" FB

## Admittance Signs (Continued)



**DANGER**  
NOT A  
PEDESTRIAN WALKWAY  
FORK TRUCKS ONLY

69410	10" x 14"	FB
84103	7" x 10"	SS
84104	10" x 14"	SS
22117	7" x 10"	PL
22118	10" x 14"	PL
40681	7" x 10"	AL
40682	10" x 14"	AL



**DANGER**  
PESTICIDE  
STORAGE  
AUTHORIZED PERSONNEL ONLY

70479	10" x 14"	FB
84107	7" x 10"	SS
84108	10" x 14"	SS
22121	7" x 10"	PL
22122	10" x 14"	PL
40685	7" x 10"	AL
40686	10" x 14"	AL



**DANGER**  
RESTRICTED  
AREA

69473	10" x 14"	FB
84110	10" x 14"	SS
22123	7" x 10"	PL
22124	10" x 14"	PL
40687	7" x 10"	AL
40688	10" x 14"	AL



**DANGER**  
ROBOTIC  
AREA  
AUTHORIZED PERSONNEL ONLY

69461	10" x 14"	FB
84111	7" x 10"	SS
84112	10" x 14"	SS
22125	7" x 10"	PL
22126	10" x 14"	PL
40689	7" x 10"	AL
40690	10" x 14"	AL



**DANGER**  
THIS ENCLOSURE CONTAINS  
HIGH VOLTAGE ELECTRICAL  
EQUIPMENT AND MUST NOT BE  
ENTERED EXCEPT BY PERMISSION

84113	7" x 10"	SS
84114	10" x 14"	SS
22127	7" x 10"	PL
22128	10" x 14"	PL
40691	7" x 10"	AL
40692	10" x 14"	AL



**DANGER**  
UNAUTHORIZED  
PERSONNEL  
KEEP OUT

95378	7" x 10"	FB
95382	10" x 14"	FB
95375	7" x 10"	SS
95379	10" x 14"	SS
95376	7" x 10"	PL
95381	10" x 14"	PL
95377	7" x 10"	AL
95380	10" x 14"	AL



**DANGER**  
UNAUTHORIZED PERSONNEL  
KEEP OUT

70565	7" x 17"	FB
-------	----------	----



**DANGER**  
UNSAFE ROOF  
KEEP OFF

74391	10" x 14"	FB
84115	7" x 10"	SS
22129	7" x 10"	PL
22130	10" x 14"	PL
40694	10" x 14"	AL



**NOTICE**  
ALL EMPLOYEES WHOSE  
WORK DOES NOT REQUIRE  
THEM TO ENTER THIS AREA  
MUST KEEP OUT

69380	10" x 14"	FB
84119	7" x 10"	SS
84120	10" x 14"	SS
22131	7" x 10"	PL
22132	10" x 14"	PL
40695	7" x 10"	AL
40696	10" x 14"	AL



**NOTICE**  
ALL LUNCH BOXES,  
PACKAGES, BAGS,  
PURSES, ETC. ARE  
SUBJECT TO INSPECTION

69382	10" x 14"	FB
84122	10" x 14"	SS
22133	7" x 10"	PL
22134	10" x 14"	PL
40698	10" x 14"	AL



**NOTICE**  
ALL TRUCK DRIVERS  
MUST SIGN IN  
BEFORE PROCEEDING  
PAST THIS POINT

95321	7" x 10"	FB
84123	7" x 10"	SS
84124	10" x 14"	SS
22135	7" x 10"	PL
22136	10" x 14"	PL
40699	7" x 10"	AL
40700	10" x 14"	AL



**NOTICE**  
ALL VEHICLES  
ENTERING OR LEAVING  
THE PREMISES ARE SUBJECT  
TO INSPECTION

69387	10" x 14"	FB
22137	7" x 10"	PL
22138	10" x 14"	PL
40702	10" x 14"	AL



**NOTICE**  
ALL VISITORS AND  
JOB APPLICANTS  
MUST STOP AND SIGN IN  
AT GATE HOUSE

40703	7" x 10"	AL
40704	10" x 14"	AL



**NOTICE**  
ALL VISITORS  
MUST GET PASS  
AT OFFICE

95214	7" x 10"	FB
95230	10" x 14"	FB
95211	7" x 10"	SS
95212	7" x 10"	PL
95213	7" x 10"	AL
95216	10" x 14"	AL



**NOTICE**  
ALL VISITORS MUST  
REGISTER AT OFFICE

95278	10" x 14"	FB
95268	7" x 10"	SS
60578	10" x 14"	SS
95275	7" x 10"	PL
60539	10" x 14"	PL
95270	7" x 10"	AL
60510	10" x 14"	AL



**NOTICE**  
AUTHORIZED  
PERSONNEL  
ONLY

73476	7" x 10"	FB
70602	10" x 14"	FB
84129	7" x 10"	SS
84130	10" x 14"	SS
22141	7" x 10"	PL
22142	10" x 14"	PL
40705	7" x 10"	AL
40706	10" x 14"	AL



**NOTICE**  
AUTHORIZED  
PERSONNEL  
ONLY

95284	7" x 17"	FB
95259	10" x 14"	FB
95254	7" x 10"	SS
95258	10" x 14"	SS
95256	7" x 10"	PL
25901	10" x 14"	PL
95255	7" x 10"	AL
43478	10" x 14"	AL



**NOTICE**  
AUTHORIZED  
PERSONNEL  
ONLY

131677	7" x 10"	FB
131678	10" x 14"	FB
131675	7" x 10"	SS
131676	10" x 14"	SS
131673	7" x 10"	PL
131674	10" x 14"	PL
131671	7" x 10"	AL
131672	10" x 14"	AL



**NOTICE**  
CONSTRUCTION SITE  
NO TRESPASSING

124811	7" x 10"	SS
124814	10" x 14"	SS
124810	7" x 10"	PL
124813	10" x 14"	PL
124809	7" x 10"	AL
124812	10" x 14"	AL



**NOTICE**  
CUSTOMERS  
NOT PERMITTED  
IN WORKING AREA

124817	7" x 10"	SS
124820	10" x 14"	SS
124816	7" x 10"	PL
124819	10" x 14"	PL
124815	7" x 10"	AL
124818	10" x 14"	AL



**NOTICE**  
DO NOT  
ENTER

131669	7" x 10"	FB
131670	10" x 14"	FB
131667	7" x 10"	SS
131668	10" x 14"	SS
131665	7" x 10"	PL
131666	10" x 14"	PL
131663	7" x 10"	AL
131664	10" x 14"	AL



**NOTICE**  
EMPLOYEES  
ONLY

122831	7" x 10"	FB
47327	10" x 14"	FB
84131	7" x 10"	SS
84132	10" x 14"	SS
22143	7" x 10"	PL
22144	10" x 14"	PL
40707	7" x 10"	AL
40708	10" x 14"	AL



**NOTICE**  
ENTRANCE FOR  
EMPLOYEES ONLY

69210	10" x 14"	FB
84133	7" x 10"	SS
84134	10" x 14"	SS
22145	7" x 10"	PL
22146	10" x 14"	PL
40709	7" x 10"	AL
40710	10" x 14"	AL



**NOTICE**  
KEEP THIS  
DOOR CLOSED

95240	7" x 10"	FB
70667	10" x 14"	FB
84732	7" x 10"	SS
84733	10" x 14"	SS
22537	7" x 10"	PL
22538	10" x 14"	PL
41101	7" x 10"	AL
41102	10" x 14"	AL





**NOTICE**  
LIMITED ACCESS AREA  
AUTHORIZED PERSONNEL  
ONLY

124823	7" x 10"	SS
124826	10" x 14"	SS
124822	7" x 10"	PL
124825	10" x 14"	PL
124821	7" x 10"	AL
124824	10" x 14"	AL



**NOTICE**  
MAINTENANCE  
PERSONNEL  
ONLY

124829	7" x 10"	SS
124832	10" x 14"	SS
124828	7" x 10"	PL
124831	10" x 14"	PL
124827	7" x 10"	AL
124830	10" x 14"	AL



**NOTICE**  
NO  
ADMITTANCE

122854	7" x 10"	FB
70699	10" x 14"	FB
122654	7" x 10"	SS
84138	10" x 14"	SS
22147	7" x 10"	PL
22148	10" x 14"	PL
40711	7" x 10"	AL
40712	10" x 14"	AL



**NOTICE**  
NO ADMITTANCE  
APPLY AT OFFICE

84140	10" x 14"	SS
22150	10" x 14"	PL
40713	7" x 10"	AL
40714	10" x 14"	AL

# Admittance Signs

BradyID.com/s34

## Admittance Signs (Continued)

Safety Signs

**NOTICE**  
NO ADMITTANCE  
EMPLOYEES ONLY

84141	7" x 10"	SS
84142	10" x 14"	SS
22151	7" x 10"	PL
22152	10" x 14"	PL
40715	7" x 10"	AL
40716	10" x 14"	AL

**NOTICE**  
NO ADMITTANCE  
WITHOUT A PERMIT

95324	7" x 10"	FB
84143	7" x 10"	SS
84144	10" x 14"	SS
40717	7" x 10"	AL
40718	10" x 14"	AL

**NOTICE**  
NO ADMITTANCE  
WITHOUT A PASS FROM  
OFFICE

84146	10" x 14"	SS
22156	10" x 14"	PL
40720	10" x 14"	AL

**NOTICE**  
NO ENTRY  
UNLESS AUTHORIZED

70713	10" x 14"	FB
84149	7" x 10"	SS
84150	10" x 14"	SS
22157	7" x 10"	PL
22158	10" x 14"	PL
40721	7" x 10"	AL
40722	10" x 14"	AL

**Popular Sign Materials**  
**FB** - Premium Fiberglass (B-120)  
**SS** - Self-Sticking Polyester (B-302)  
**BGSS** - BradyGlo™ Self-Sticking Polyester (B-324)  
**BGPL** - BradyGlo™ Plastic (B-347)  
**PL** - Plastic (B-401)  
**AL** - Aluminum (B-555)  
*View all sign materials on page 25.*  
**Can't find your sign?**  
*Use the Sign Legend Index on page 498 or take advantage of our custom sign options.*

**NOTICE**  
NO ENTRY  
UNLESS  
AUTHORIZED



25902	10" x 14"	PL
43479	10" x 14"	AL

**NOTICE**  
NO FIREARMS  
ALLOWED ON  
PREMISES



84908	10" x 14"	SS
23092	10" x 14"	PL
84907	10" x 14"	AL

**NOTICE**  
NO SOLICITATION OR  
DISTRIBUTION OF MATERIALS  
ALLOWED ON COMPANY  
PROPERTY AT ANY TIME

84151	7" x 10"	SS
84152	10" x 14"	SS
22160	10" x 14"	PL
40723	7" x 10"	AL
40724	10" x 14"	AL

**NOTICE**  
NO  
SOLICITING

84153	7" x 10"	SS
84154	10" x 14"	SS
22161	7" x 10"	PL
22162	10" x 14"	PL
40725	7" x 10"	AL
40726	10" x 14"	AL

**NOTICE**  
NO  
TRESPASSING

122850	7" x 10"	FB
47330	10" x 14"	FB
75510	14" x 20"	FB
84155	7" x 10"	SS
84156	10" x 14"	SS
22163	7" x 10"	PL
22164	10" x 14"	PL
122412	7" x 10"	AL
40728	10" x 14"	AL

**NOTICE**  
NO  
TRESPASSING



95285	7" x 17"	FB
-------	----------	----

**NOTICE**  
NO TRESPASSING  
ON THIS PROPERTY  
UNDER PENALTY  
OF THE LAW

95236	10" x 14"	SS
95233	7" x 10"	PL
95238	10" x 14"	PL
95237	10" x 14"	AL

**NOTICE**  
NOT AN  
ENTRANCE

95283	7" x 10"	FB
95291	10" x 14"	FB
95279	7" x 10"	SS
95288	10" x 14"	SS
95280	7" x 10"	PL
95290	10" x 14"	PL
95281	7" x 10"	AL
95289	10" x 14"	AL

**NOTICE**  
NOT AN  
EXIT

95296	10" x 14"	SS
95293	7" x 10"	PL
95298	10" x 14"	PL
95294	7" x 10"	AL
95297	10" x 14"	AL

**NOTICE**  
ONLY AUTHORIZED  
PERSONS TO ENTER  
THIS AREA

84159	7" x 10"	SS
84160	10" x 14"	SS
22166	10" x 14"	PL
40729	7" x 10"	AL
40730	10" x 14"	AL

**NOTICE**  
PRIVATE PROPERTY  
KEEP OUT

69446	10" x 14"	FB
22168	10" x 14"	PL
40732	10" x 14"	AL

**NOTICE**  
PRIVATE PROPERTY  
VIOLATORS WILL BE  
PROSECUTED

69447	10" x 14"	FB
40734	10" x 14"	AL

**NOTICE**  
RESTRICTED  
AREA

95310	10" x 14"	FB
95300	7" x 10"	SS
95301	7" x 10"	PL
95309	10" x 14"	PL
95305	7" x 10"	AL

**NOTICE**  
RESTRICTED AREA  
AUTHORIZED  
PERSONNEL ONLY

95248	10" x 14"	FB
95241	7" x 10"	SS
95245	10" x 14"	SS
95242	7" x 10"	PL
95247	10" x 14"	PL
95243	7" x 10"	AL
95246	10" x 14"	AL

**NOTICE**  
RESTRICTED AREA  
KEEP OUT

69477	10" x 14"	FB
84167	7" x 10"	SS
84168	10" x 14"	SS
22171	7" x 10"	PL
22172	10" x 14"	PL
40736	10" x 14"	AL

**NOTICE**  
SECURITY ALARM  
WILL SOUND IF  
DOOR IS OPENED

95311	7" x 10"	FB
70522	10" x 14"	FB
84736	7" x 10"	SS
84737	10" x 14"	SS
22541	7" x 10"	PL
22542	10" x 14"	PL
41106	10" x 14"	AL

**NOTICE**  
THESE PREMISES  
PROTECTED BY  
CLOSED CIRCUIT TV

84171	7" x 10"	SS
84172	10" x 14"	SS
22173	7" x 10"	PL
22174	10" x 14"	PL
40737	7" x 10"	AL

**NOTICE**  
THIS IS A  
DRUG-FREE  
WORKPLACE

124835	7" x 10"	SS
124838	10" x 14"	SS
124834	7" x 10"	PL
124837	10" x 14"	PL
124833	7" x 10"	AL
124836	10" x 14"	AL

**NOTICE**  
THIS PROPERTY  
PROTECTED BY  
ELECTRONIC  
SURVEILLANCE

95316	7" x 10"	B-120
95312	7" x 10"	B-302
95317	10" x 14"	B-302
95314	7" x 10"	B-401
95419	10" x 14"	B-401
95315	7" x 10"	B-555
95318	10" x 14"	B-555

**NOTICE**  
TRESPASSERS  
WILL BE  
PROSECUTED



95263	7" x 10"	FB
95266	10" x 14"	PL
95262	7" x 10"	AL
95265	10" x 14"	AL

**NOTICE**  
UNAUTHORIZED  
PERSONNEL  
ARE NOT PERMITTED  
INSIDE PLANT

70567	14" x 20"	FB
84173	7" x 10"	SS
84174	10" x 14"	SS
22175	7" x 10"	PL
22176	10" x 14"	PL
40739	7" x 10"	AL
40740	10" x 14"	AL

**RESTRICTED  
AREA**  
AUTHORIZED  
EMPLOYEES  
ONLY

122910	7" x 10"	FB
70220	10" x 14"	FB
84175	7" x 10"	SS
84176	10" x 14"	SS
22177	7" x 10"	PL
22178	10" x 14"	PL
40741	7" x 10"	AL
40742	10" x 14"	AL

**RESTRICTED  
AREA**  
KEEP OUT

84179	7" x 10"	SS
22181	7" x 10"	PL
40746	10" x 14"	AL



## Admittance Signs (Continued)



71335	10" x 14"	FB
84181	7" x 10"	SS
84182	10" x 14"	SS
22183	7" x 10"	PL
22184	10" x 14"	PL
40747	7" x 10"	AL
40748	10" x 14"	AL



71229	14" x 20"	FB
84183	7" x 10"	SS
84184	10" x 14"	SS
22185	7" x 10"	PL
22186	10" x 14"	PL
40749	7" x 10"	AL
40750	10" x 14"	AL



71258	14" x 20"	FB
84185	7" x 10"	SS
84186	10" x 14"	SS
22187	7" x 10"	PL
22188	10" x 14"	PL
40751	7" x 10"	AL
40752	10" x 14"	AL



122857	7" x 10"	FB
71389	10" x 14"	FB
87758	3-1/2" x 5"	SS
84187	7" x 10"	SS
84188	10" x 14"	SS
122525	7" x 10"	PL
22190	10" x 14"	PL
40753	7" x 10"	AL
40754	10" x 14"	AL



123476	7" x 10"	SS
123479	10" x 14"	SS
123475	7" x 10"	PL
123478	10" x 14"	PL
123474	7" x 10"	AL
123477	10" x 14"	AL



69099	10" x 14"	FB
84189	7" x 10"	SS
84190	10" x 14"	SS
22191	7" x 10"	PL
22192	10" x 14"	PL
40755	7" x 10"	AL
40756	10" x 14"	AL



69566	10" x 14"	FB
84191	7" x 10"	SS
84192	10" x 14"	SS
40757	7" x 10"	AL
40758	10" x 14"	AL



127070	7" x 10"	SS
127073	10" x 14"	SS
127069	7" x 10"	PL
127072	10" x 14"	PL
127068	7" x 10"	AL
127071	10" x 14"	AL



69575	10" x 14"	FB
84195	7" x 10"	SS
84196	10" x 14"	SS
22195	7" x 10"	PL
22196	10" x 14"	PL
40759	7" x 10"	AL
40760	10" x 14"	AL



69580	10" x 14"	FB
84197	7" x 10"	SS
84198	10" x 14"	SS
22197	7" x 10"	PL
22198	10" x 14"	PL
40761	7" x 10"	AL
40762	10" x 14"	AL



69591	10" x 14"	FB
84199	7" x 10"	SS
84200	10" x 14"	SS
22199	7" x 10"	PL
22200	10" x 14"	PL
40763	7" x 10"	AL
40764	10" x 14"	AL



69603	10" x 14"	FB
84203	7" x 10"	SS
84204	10" x 14"	SS
22201	7" x 10"	PL
22202	10" x 14"	PL
40765	7" x 10"	AL
40766	10" x 14"	AL



69606	10" x 14"	FB
84205	7" x 10"	SS
84206	10" x 14"	SS
22203	7" x 10"	PL
22204	10" x 14"	PL
40767	7" x 10"	AL
40768	10" x 14"	AL



69612	10" x 14"	FB
84207	7" x 10"	SS
84208	10" x 14"	SS
22205	7" x 10"	PL
22206	10" x 14"	PL
40769	7" x 10"	AL
40770	10" x 14"	AL

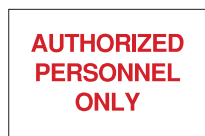

122851	7" x 10"	FB
70833	10" x 14"	FB
84212	7" x 10"	SS
84213	10" x 14"	SS
22207	7" x 10"	PL
22208	10" x 14"	PL
122413	7" x 10"	AL
40772	10" x 14"	AL



122907	7" x 10"	FB
122768	10" x 14"	FB
122697	7" x 10"	SS
122620	10" x 14"	SS
122560	7" x 10"	PL
122497	10" x 14"	PL
122456	7" x 10"	AL
122385	10" x 14"	AL



84211	4-1/2" x 10"	SS
-------	--------------	----

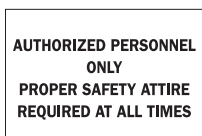

70846	14" x 20"	FB
84215	10" x 14"	SS
22209	7" x 10"	PL
22210	10" x 14"	PL
40773	7" x 10"	AL
40774	10" x 14"	AL



122868	7" x 10"	FB
70632	10" x 14"	FB
80037	7" x 10"	SS
122622	10" x 14"	SS
25977	7" x 10"	PL
25978	10" x 14"	PL
122459	7" x 10"	AL
43906	10" x 14"	AL

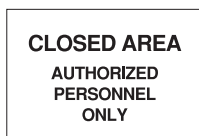

122852	7" x 10"	FB
70863	10" x 14"	FB
84218	7" x 10"	SS
84219	10" x 14"	SS
22213	7" x 10"	PL
22214	10" x 14"	PL
122414	7" x 10"	AL
40778	10" x 14"	AL



22216	10" x 14"	PL
40780	10" x 14"	AL



69096	10" x 14"	FB
87757	3-1/2" x 5"	SS
84222	7" x 10"	SS
84223	10" x 14"	SS
22217	7" x 10"	PL
22218	10" x 14"	PL
40781	7" x 10"	AL



95442	10" x 14"	PL
-------	-----------	----



84226	7" x 10"	SS
84227	10" x 14"	SS
22219	7" x 10"	PL



95443	10" x 14"	PL
-------	-----------	----

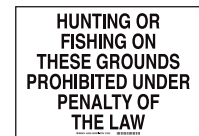

69032	10" x 14"	FB
43356	10" x 14"	AL



# Admittance Signs

BradyID.com/s34

## Admittance Signs (Continued)



84236	5' x 14'	SS
22220	7' x 10'	PL



71136	10' x 14'	FB
84237	7' x 10'	SS
84238	10' x 14'	SS
22221	7' x 10'	PL
22222	10' x 14'	PL
40785	7' x 10'	AL
40786	10' x 14'	AL



123458	7' x 10'	SS
123461	10' x 14'	SS
123457	7' x 10'	PL
123460	10' x 14'	PL
123456	7' x 10'	AL
123459	10' x 14'	AL



71142	20' x 28'	FB
84239	7' x 10'	SS
84240	10' x 14'	SS
22224	10' x 14'	PL
40788	10' x 14'	AL

**Popular Sign Materials**

**FB** - Premium Fiberglass (B-120)  
**SS** - Self-Sticking Polyester (B-302)  
**BGSS** - BradyGlo™ Self-Sticking Polyester (B-324)  
**BGPL** - BradyGlo™ Plastic (B-347)  
**PL** - Plastic (B-401)  
**AL** - Aluminum (B-555)

*View all sign materials on page 25.*

**Can't find your sign?**  
*Use the Sign Legend Index on page 498 or take advantage of our custom sign options.*



124805	7' x 10'	SS
124808	10' x 14'	SS
124804	7' x 10'	PL
124807	10' x 14'	PL
124803	7' x 10'	AL
124806	10' x 14'	AL



123550	14' x 10'	SS
123547	10' x 7'	SS
123549	14' x 10'	PL
123546	10' x 7'	PL
123548	14' x 10'	AL
123545	10' x 7'	AL



123556	14' x 10'	SS
123553	10' x 7'	SS
123555	14' x 10'	PL
123552	10' x 7'	PL
123554	14' x 10'	AL
123551	10' x 7'	AL



69793	7' x 7'	FB
88517	7' x 7'	SS
25179	7' x 10'	PL
42756	7' x 10'	AL



123513	14' x 10'	SS
123510	10' x 7'	SS
123512	14' x 10'	PL
123509	10' x 7'	PL
123511	14' x 10'	AL
123508	10' x 7'	AL



123544	14' x 10'	SS
123541	10' x 7'	SS
123543	14' x 10'	PL
123540	10' x 7'	PL
123542	14' x 10'	AL
123539	10' x 7'	AL



84245	7' x 10'	SS
84246	10' x 14'	SS
22225	7' x 10'	PL
22226	10' x 14'	PL
40789	7' x 10'	AL
40790	10' x 14'	AL



123504	7' x 10'	SS
123507	10' x 14'	SS
123503	7' x 10'	PL
123506	10' x 14'	PL
123502	7' x 10'	AL
123505	10' x 14'	AL



95445	10' x 14'	PL
-------	-----------	----

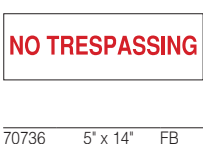

70736	5' x 14'	FB
122800	7' x 10'	FB
122708	10' x 14'	FB
84247	5' x 14'	SS
122639	7' x 10'	SS
122568	10' x 14'	SS
22227	7' x 10'	PL
122470	10' x 14'	PL
40791	7' x 10'	AL
122344	10' x 14'	AL



71199	20' x 28'	FB
84249	10' x 14'	SS
22228	7' x 10'	PL
22229	10' x 14'	PL
40792	7' x 10'	AL
40793	10' x 14'	AL

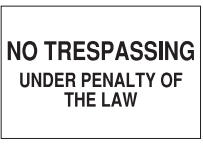

69405	10' x 14'	FB
84251	10' x 14'	SS
40795	10' x 14'	AL



122801	7' x 10'	FB
122709	10' x 14'	FB
71216	14' x 20'	FB
84252	7' x 10'	SS
122569	10' x 14'	SS
22232	7' x 10'	PL
22233	10' x 14'	PL
40796	7' x 10'	AL
40797	10' x 14'	AL



95446	10' x 14'	PL
-------	-----------	----



70747	10' x 14'	FB
22234	7' x 10'	PL
40798	7' x 10'	AL
40799	10' x 14'	AL



124865	7' x 10'	SS
124868	10' x 14'	SS
124864	7' x 10'	PL
124867	10' x 14'	PL
124863	7' x 10'	AL
124866	10' x 14'	AL



73469	14' x 10'	FB
84257	14' x 10'	SS
84256	10' x 7'	SS
22237	14' x 10'	PL
22236	10' x 7'	PL
40801	14' x 10'	AL
40800	10' x 7'	AL



124871	7' x 10'	SS
124874	10' x 14'	SS
124870	7' x 10'	PL
124873	10' x 14'	PL
124869	7' x 10'	AL
124872	10' x 14'	AL

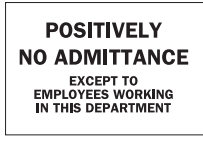

84258	7' x 10'	SS
84259	10' x 14'	SS
40803	10' x 14'	AL



69449	7' x 10'	FB
84260	7' x 10'	SS
22241	10' x 14'	PL
40805	10' x 14'	AL



70753	10' x 14'	FB
84263	10' x 14'	SS
40806	7' x 10'	AL
40807	10' x 14'	AL



69445	10' x 14'	FB
40808	7' x 10'	AL
40809	10' x 14'	AL



124847	7' x 10'	SS
124850	10' x 14'	SS
124846	7' x 10'	PL
124849	10' x 14'	PL
124845	7' x 10'	AL
124848	10' x 14'	AL

Safety Signs

## Admittance Signs (Continued)



84266	7" x 10"	SS
84267	10" x 14"	SS
22246	7" x 10"	PL
22247	10" x 14"	PL
40810	7" x 10"	AL
40811	10" x 14"	AL



124853	7" x 10"	SS
124856	10" x 14"	SS
124852	7" x 10"	PL
124855	10" x 14"	PL
124851	7" x 10"	AL
124854	10" x 14"	AL



122883	7" x 10"	FB
122744	10" x 14"	FB
71282	14" x 20"	FB
122679	7" x 10"	SS
122602	10" x 14"	SS
122548	7" x 10"	PL
122485	10" x 14"	PL
122439	7" x 10"	AL
122370	10" x 14"	AL



124892	24" x 24"	SS
124889	18" x 18"	SS
124891	24" x 24"	PL
124888	18" x 18"	PL
124890	24" x 24"	AL
124887	18" x 18"	AL



124841	7" x 10"	SS
124844	10" x 14"	SS
124840	7" x 10"	PL
124843	10" x 14"	PL
124839	7" x 10"	AL
124842	10" x 14"	AL



124859	7" x 10"	SS
124862	10" x 14"	SS
124858	7" x 10"	PL
124861	10" x 14"	PL
124857	7" x 10"	AL
124860	10" x 14"	AL



122884	7" x 10"	FB
71293	10" x 14"	FB
71288	14" x 20"	FB
122680	7" x 10"	SS
84269	10" x 14"	SS
22248	7" x 10"	PL
22249	10" x 14"	PL
40812	7" x 10"	AL
40813	10" x 14"	AL



123464	7" x 10"	SS
123467	10" x 14"	SS
123463	7" x 10"	PL
123466	10" x 14"	PL
123462	7" x 10"	AL
123465	10" x 14"	AL



84270	7" x 10"	SS
22251	10" x 14"	PL
40815	10" x 14"	AL



123498	10" x 7"	SS
123501	14" x 10"	SS
123497	10" x 7"	PL
123500	14" x 10"	PL
123496	10" x 7"	AL
123499	14" x 10"	AL



69448	10" x 14"	FB
-------	-----------	----



84274	7" x 10"	SS
84275	10" x 14"	SS
22254	7" x 10"	PL
22255	10" x 14"	PL
40818	7" x 10"	AL
40819	10" x 14"	AL



71326	14" x 20"	FB
84276	7" x 10"	SS
84277	10" x 14"	SS
22256	7" x 10"	PL
40820	7" x 10"	AL



71313	5" x 14"	FB
84278	5" x 14"	SS



84279	7" x 10"	SS
22257	7" x 10"	PL
22258	10" x 14"	PL
40821	7" x 10"	AL



124877	7" x 10"	SS
124880	10" x 14"	SS
124876	7" x 10"	PL
124879	10" x 14"	PL
124875	7" x 10"	AL
124878	10" x 14"	AL



95447	10" x 14"	PL
-------	-----------	----

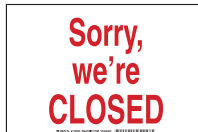

124883	7" x 10"	SS
124886	10" x 14"	SS
124882	7" x 10"	PL
124885	10" x 14"	PL
124881	7" x 10"	AL
124884	10" x 14"	AL



95448	10" x 14"	PL
-------	-----------	----



71396	14" x 20"	FB
84284	10" x 14"	SS
22260	7" x 10"	PL
22261	10" x 14"	PL
40825	10" x 14"	AL



123491	10" x 7"	SS
123494	14" x 10"	SS
123490	10" x 7"	PL
123493	14" x 10"	PL
123489	10" x 7"	AL
123492	14" x 10"	AL



123470	7" x 10"	SS
123473	10" x 14"	SS
123469	7" x 10"	PL
123472	10" x 14"	PL
123468	7" x 10"	AL
123471	10" x 14"	AL



# ANSI Signs

BradyID.com/s34

## ANSI Z535 Signs

Brady offers a variety of ANSI safety signs to help you prevent accidents and enhance productivity and safety within your facility. ANSI signs are highly visible and provide recognizable safety alert messages for workplace caution, warning, notice, danger and more. Brady's ANSI signs adhere to ANSI Z535.1, Z535.2 and Z535.5 safety standards for colors and symbols and can be understood by employees and visitors of all cultural backgrounds.

### Popular Sign Materials

- FB** - Premium Fiberglass (B-120)
  - SS** - Self-Sticking Polyester (B-302)
  - BGSS** - BradyGlo™ Self-Sticking Polyester (B-324)
  - BGPL** - BradyGlo™ Plastic (B-347)
  - PL** - Plastic (B-401)
  - AL** - Aluminum (B-555)
- View all sign materials on page 25.*

**Can't find your sign?**  
Use the Sign Legend Index on page 498 or take advantage of our custom sign options.

Safety Signs



144791	7" x 10"	SS
144792	10" x 14"	SS
144793	7" x 10"	PL
144794	10" x 14"	PL
144795	7" x 10"	AL
144796	10" x 14"	AL



144816	7" x 10"	SS
144817	10" x 14"	SS
144818	7" x 10"	PL
144815	10" x 14"	PL
144819	7" x 10"	AL
144820	10" x 14"	AL



144336	7" x 10"	SS
144347	10" x 14"	SS
144337	7" x 10"	PL
144338	10" x 14"	PL
144339	7" x 10"	AL
144340	10" x 14"	AL



144844	7" x 10"	SS
144845	10" x 14"	SS
144840	7" x 10"	PL
144841	10" x 14"	PL
144842	7" x 10"	AL
144843	10" x 14"	AL



144833	10" x 14"	FB
144836	7" x 10"	SS
144837	10" x 14"	SS
144834	7" x 10"	PL
144835	10" x 14"	PL
144838	7" x 10"	AL
144839	10" x 14"	AL



144348	10" x 14"	FB
144349	7" x 10"	SS
144350	10" x 14"	SS
144351	7" x 10"	PL
144352	10" x 14"	PL
144353	7" x 10"	AL
144354	10" x 14"	AL



144600	7" x 10"	SS
144598	7" x 10"	PL
144597	7" x 10"	AL



144589	10" x 14"	FB
144601	10" x 14"	SS
144599	10" x 14"	PL
144590	10" x 14"	AL



144160	7" x 10"	SS
144163	10" x 14"	SS
144161	7" x 10"	PL
144158	10" x 14"	PL
144159	7" x 10"	AL
144162	10" x 14"	AL



143867	7" x 10"	SS
143868	10" x 14"	SS
143866	7" x 10"	PL
143865	10" x 14"	PL
143869	7" x 10"	AL
143870	10" x 14"	AL

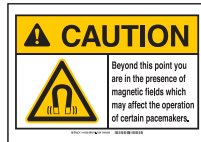

144529	7" x 10"	SS
144528	10" x 14"	SS
144527	7" x 10"	PL
144531	10" x 14"	PL
144530	7" x 10"	AL
144526	10" x 14"	AL



144171	7" x 10"	SS
144174	10" x 14"	SS
144173	7" x 10"	PL
144170	10" x 14"	PL
144175	7" x 10"	AL
144172	10" x 14"	AL



144859	7" x 10"	SS
144860	10" x 14"	SS
144861	7" x 10"	PL
144862	10" x 14"	PL
144863	7" x 10"	AL
144858	10" x 14"	AL



144180	10" x 14"	FB
144178	7" x 10"	SS
144182	10" x 14"	SS
144176	7" x 10"	PL
144179	10" x 14"	PL
144177	7" x 10"	AL
144181	10" x 14"	AL



144893	10" x 14"	FB
144892	7" x 10"	SS
144894	10" x 14"	SS
144895	7" x 10"	PL
144896	10" x 14"	PL
144897	7" x 10"	AL
144898	10" x 14"	AL



143937	7" x 10"	SS
143936	10" x 14"	SS
143935	7" x 10"	PL
143933	10" x 14"	PL
143934	7" x 10"	AL
143932	10" x 14"	AL



143938	7" x 10"	SS
143939	10" x 14"	SS
143940	7" x 10"	PL
143941	10" x 14"	PL
143942	7" x 10"	AL
143943	10" x 14"	AL



144918	7" x 10"	SS
144919	10" x 14"	SS
144920	7" x 10"	PL
144921	10" x 14"	PL
144922	7" x 10"	AL
144923	10" x 14"	AL



144952	7" x 10"	SS
144950	10" x 14"	SS
144951	7" x 10"	PL
144949	10" x 14"	PL
144953	7" x 10"	AL
144954	10" x 14"	AL



143731	7" x 10"	SS
143748	10" x 14"	SS
143752	7" x 10"	PL
143751	10" x 14"	PL
143749	10" x 14"	AL



45033	10" x 7"	FB
45102	14" x 10"	PL
49021	10" x 7"	AL



143747	7" x 10"	SS
143740	10" x 14"	SS
143750	7" x 10"	AL
143743	10" x 14"	AL



143746	10" x 14"	FB
--------	-----------	----

**NEW!**

## New ANSI Sign Standard

OSHA's recent Consensus Standard updates the previous sign design by adding visual pictograms, a safety alert symbol in the header, upper and lower case text, and more explanatory text regarding the nature of the hazard, how to avoid the hazard, and consequences of not avoiding the hazard.

A safety alert symbol needed for Danger, Warning and Caution signs

Text is succinct, active tense, left justified and follows character case rules

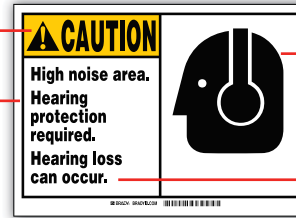

Greater use of symbols and pictograms

Communicates hazard, consequence and avoidance statements



144191 7" x 10" FB  
144222 7" x 10" SS  
144225 10" x 14" PL  
144195 10" x 14" SS  
144223 7" x 10" PL  
144224 7" x 10" AL  
144227 10" x 14" AL



143952 7" x 10" SS  
143953 10" x 14" SS  
143950 7" x 10" PL  
143951 10" x 14" PL  
143954 7" x 10" AL  
143955 10" x 14" AL



144221 7" x 10" FB  
144226 10" x 14" SS



45039 10" x 7" FB  
45040 14" x 10" FB  
45175 10" x 7" SS  
45176 14" x 10" SS  
45107 10" x 7" PL  
45108 14" x 10" PL  
49027 10" x 7" AL



143957 3-1/2" x 5" SS  
143960 10" x 14" PL



144234 10" x 14" FB  
144236 7" x 10" SS  
144240 10" x 14" SS  
144238 7" x 10" PL  
144235 10" x 14" PL  
144237 7" x 10" AL  
144239 10" x 14" AL



144241 20" x 14" FB  
144243 10" x 7" SS  
144246 14" x 10" SS  
144244 10" x 7" PL  
144245 14" x 10" PL  
144242 10" x 7" AL  
144247 14" x 10" AL



144261 7" x 10" FB  
144265 10" x 14" SS  
144259 7" x 10" PL  
144262 10" x 14" PL  
144260 7" x 10" AL  
144263 10" x 14" AL



144266 14" x 10" FB  
144267 10" x 7" SS  
144268 14" x 10" SS  
144269 10" x 7" PL  
144270 14" x 10" PL  
144271 10" x 7" AL  
144272 14" x 10" AL



144275 7" x 10" SS  
144276 10" x 14" SS  
144274 7" x 10" PL  
144273 10" x 14" PL  
144277 7" x 10" AL  
144278 10" x 14" AL



144283 7" x 10" SS  
144282 10" x 14" SS  
144281 7" x 10" PL  
144279 10" x 14" PL  
144284 7" x 10" AL  
144280 10" x 14" AL



144286 7" x 10" SS  
144287 10" x 14" SS  
144285 7" x 10" PL  
144289 10" x 14" PL  
144290 7" x 10" AL  
144288 10" x 14" AL



144294 7" x 10" SS  
144295 10" x 14" SS  
144293 7" x 10" PL  
144292 10" x 14" PL  
144296 7" x 10" AL  
144291 10" x 14" AL



144299 20" x 14" FB  
144303 10" x 7" SS  
144301 14" x 10" SS  
144300 10" x 7" PL  
144305 14" x 10" PL  
144302 10" x 7" AL  
144298 14" x 10" AL



144312 7" x 10" SS  
144313 10" x 14" SS  
144314 7" x 10" PL  
144315 10" x 14" PL  
144316 7" x 10" AL  
144317 10" x 14" AL



144989 7" x 10" SS  
144990 10" x 14" SS  
144991 7" x 10" PL  
144988 10" x 14" PL  
144993 7" x 10" AL  
144992 10" x 14" AL



45008 14" x 10" FB  
45143 10" x 7" SS  
45144 14" x 10" SS  
45075 10" x 7" PL  
45076 14" x 10" PL  
48995 10" x 7" AL  
48996 14" x 10" AL



62809 10" x 14" FB  
83925 3-1/2" x 5" SS  
21797 7" x 10" PL  
26572 10" x 14" PL  
46473 7" x 10" AL  
46750 10" x 14" AL



144121 7" x 10" SS  
144122 10" x 14" SS



144142 7" x 10" SS  
144143 10" x 14" SS  
144138 7" x 10" PL  
144141 10" x 14" PL  
144140 7" x 10" AL  
144139 10" x 14" AL



144714 7" x 10" SS  
144715 10" x 14" SS  
144712 7" x 10" PL  
144713 10" x 14" PL  
144716 7" x 10" AL  
144717 10" x 14" AL



122905 7" x 10" FB  
62738 10" x 14" FB  
83887 3-1/2" x 5" SS  
83664 7" x 10" SS  
21713 7" x 10" PL  
26534 10" x 14" PL  
122454 7" x 10" AL  
46674 10" x 14" AL



62551 7" x 10" FB  
62813 10" x 14" FB  
83929 3-1/2" x 5" SS  
83754 7" x 10" SS  
21801 7" x 10" PL  
26576 10" x 14" PL  
46477 7" x 10" AL  
46754 10" x 14" AL



145071 7" x 10" SS  
145073 10" x 14" SS  
145074 7" x 10" PL  
145075 10" x 14" PL  
145072 7" x 10" AL  
145070 10" x 14" AL



# ANSI Signs

BradyID.com/s34

## ANSI Signs (Continued)



44989	10" x 7"	FB
44990	14" x 10"	FB
45125	10" x 7"	SS
45126	14" x 10"	SS
45057	10" x 7"	PL
45058	14" x 10"	PL
48977	10" x 7"	AL
48978	14" x 10"	AL



145118	7" x 10"	SS
145116	10" x 14"	SS
145120	7" x 10"	PL
145119	10" x 14"	PL
145115	7" x 10"	AL
145117	10" x 14"	AL



145124	7" x 10"	SS
145125	10" x 14"	SS
145126	7" x 10"	PL
145127	10" x 14"	PL
145123	7" x 10"	AL
145122	10" x 14"	AL



62545	7" x 10"	FB
62807	10" x 14"	FB
83923	3-1/2" x 5"	SS
83748	7" x 10"	SS
122611	10" x 14"	SS
21795	7" x 10"	PL
26570	10" x 14"	PL
46471	7" x 10"	AL
46748	10" x 14"	AL

### Popular Sign Materials

**FB** - Premium Fiberglass (B-120)  
**SS** - Self-Sticking Polyester (B-302)  
**BGSS** - BradyGlo™ Self-Sticking Polyester (B-324)  
**BGPL** - BradyGlo™ Plastic (B-347)  
**PL** - Plastic (B-401)  
**AL** - Aluminum (B-555)

*View all sign materials on page 25.*

**Can't find your sign?**  
*Use the Sign Legend Index on page 498 or take advantage of our custom sign options.*



45004	14" x 10"	FB
45139	10" x 7"	SS
45140	14" x 10"	SS
45071	10" x 7"	PL
45072	14" x 10"	PL
48991	10" x 7"	AL
48992	14" x 10"	AL



144128	7" x 10"	SS
144130	10" x 14"	SS
144126	7" x 10"	PL
144127	10" x 14"	PL
144129	7" x 10"	AL
144131	10" x 14"	AL



143830	7" x 10"	PL
143829	10" x 14"	AL



143847	7" x 10"	SS
143848	10" x 14"	SS
143849	7" x 10"	PL
143850	10" x 14"	PL
143846	7" x 10"	AL
143851	10" x 14"	AL



143816	3-1/2" x 5"	SS
143817	7" x 10"	SS
143821	10" x 14"	SS
143819	7" x 10"	PL
143822	10" x 14"	PL
143818	7" x 10"	AL
143820	10" x 14"	AL



62538	7" x 10"	FB
122754	10" x 14"	FB
83916	3-1/2" x 5"	SS
83741	7" x 10"	SS
122689	7" x 10"	SS
21788	7" x 10"	PL
26563	10" x 14"	PL
46464	7" x 10"	AL
46741	10" x 14"	AL



143859	7" x 10"	PL
143860	10" x 14"	PL
143863	7" x 10"	SS
143864	10" x 14"	SS
143862	7" x 10"	AL
143861	10" x 14"	AL



144427	7" x 10"	SS
144429	10" x 14"	SS
144428	7" x 10"	PL
144430	10" x 14"	PL
144431	7" x 10"	AL
144432	10" x 14"	AL



144433	10" x 7"	SS
144434	14" x 10"	SS
144435	10" x 7"	PL
144436	14" x 10"	PL
144437	10" x 7"	AL
144438	14" x 10"	AL



144534	7" x 10"	SS
144535	10" x 14"	SS
144533	7" x 10"	PL
144532	10" x 14"	PL
144536	7" x 10"	AL
144537	10" x 14"	AL



144494	10" x 7"	FB
144497	5" x 3-1/2"	SS
144499	10" x 7"	SS
144498	14" x 10"	SS
144500	10" x 7"	PL
144495	14" x 10"	PL
144502	10" x 7"	AL
144496	14" x 10"	AL



144450	7" x 10"	SS
144451	10" x 14"	SS
144448	7" x 10"	PL
144446	10" x 14"	PL
144449	7" x 10"	AL
144447	10" x 14"	AL



143989	7" x 10"	SS
143992	10" x 14"	SS
143991	7" x 10"	PL
143994	10" x 14"	PL
143990	7" x 10"	AL
143993	10" x 14"	AL



144000	10" x 14"	FB
144002	3-1/2" x 5"	SS
143999	7" x 10"	SS
143995	10" x 14"	SS
143998	7" x 10"	PL
143996	10" x 14"	PL
143997	7" x 10"	AL
144001	10" x 14"	AL



45031	10" x 7"	FB
45032	14" x 10"	FB
45167	10" x 7"	SS
45168	14" x 10"	SS
45099	10" x 7"	PL
45100	14" x 10"	PL
49019	10" x 7"	AL
49020	14" x 10"	AL



144562	7" x 10"	SS
144563	10" x 14"	SS
144564	7" x 10"	PL
144565	10" x 14"	PL
144566	7" x 10"	AL
144567	10" x 14"	AL



143765	14" x 20"	FB
143769	7" x 10"	SS
143768	10" x 14"	SS
143766	7" x 10"	PL
143767	10" x 14"	PL
143770	7" x 10"	AL
143771	10" x 14"	AL



144718	7" x 10"	SS
144719	10" x 14"	SS
144720	7" x 10"	PL
144721	10" x 14"	PL
144722	7" x 10"	AL
144723	10" x 14"	AL



143701	7" x 10"	SS
143702	10" x 14"	SS
143704	7" x 10"	PL
143703	10" x 14"	PL
143706	7" x 10"	AL
143705	10" x 14"	AL



145199	10" x 14"	FB
145198	7" x 10"	SS
145202	10" x 14"	SS
145201	7" x 10"	PL
145204	10" x 14"	PL
145200	7" x 10"	AL
145203	10" x 14"	AL



144724	7" x 10"	SS
144725	10" x 14"	SS
144726	7" x 10"	PL
144727	10" x 14"	PL
144728	7" x 10"	AL
144729	10" x 14"	AL



144324	7" x 10"	SS
144325	10" x 14"	SS
144326	7" x 10"	PL
144327	10" x 14"	PL
144328	7" x 10"	AL
144329	10" x 14"	AL



144025	10" x 14"	FB
144028	7" x 10"	SS
144029	10" x 14"	SS
144026	7" x 10"	PL
144023	10" x 14"	PL
144027	7" x 10"	AL
144024	10" x 14"	AL

## ANSI Signs (Continued)



143889	10" x 7"	SS
143890	14" x 10"	SS
143887	10" x 7"	PL
143888	14" x 10"	PL
143886	10" x 7"	AL
143885	14" x 10"	AL



122830	7" x 10"	FB
62734	10" x 14"	FB
83883	3-1/2" x 5"	SS
83660	7" x 10"	SS
122575	10" x 14"	SS
21709	7" x 10"	PL
26530	10" x 14"	PL
46626	7" x 10"	AL
46670	10" x 14"	AL



143912	3-1/2" x 5"	SS
--------	-------------	----



145222	7" x 10"	SS
145220	10" x 14"	SS
145223	7" x 10"	PL
145224	10" x 14"	PL
145221	7" x 10"	AL
145219	10" x 14"	AL

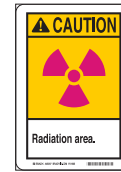

45029	10" x 7"	FB
45165	10" x 7"	SS
45166	14" x 10"	SS
45097	10" x 7"	PL
49017	10" x 7"	AL
49018	14" x 10"	AL



45025	10" x 7"	FB
45026	14" x 10"	FB
45161	10" x 7"	SS
45162	14" x 10"	SS
45093	10" x 7"	PL
45094	14" x 10"	PL
49013	10" x 7"	AL
49014	14" x 10"	AL



145240	7" x 10"	SS
145241	10" x 14"	SS
145238	7" x 10"	PL
145239	10" x 14"	PL
145242	7" x 10"	AL
145243	10" x 14"	AL



45041	10" x 7"	FB
45042	14" x 10"	FB
45177	10" x 7"	SS
45178	14" x 10"	SS
45109	10" x 7"	PL
45110	14" x 10"	PL
49029	10" x 7"	AL
49030	14" x 10"	AL



144754	7" x 10"	SS
144751	10" x 14"	SS
144753	7" x 10"	PL
144750	10" x 14"	PL
144755	7" x 10"	AL
144752	10" x 14"	AL



144758	10" x 14"	FB
144761	7" x 10"	SS
144762	10" x 14"	SS
144759	7" x 10"	PL
144756	10" x 14"	PL
144757	7" x 10"	AL
144760	10" x 14"	AL



144523	10" x 7"	SS
144521	14" x 10"	SS
144524	10" x 7"	PL
144525	14" x 10"	PL
144522	10" x 7"	AL
144520	14" x 10"	AL



143896	7" x 10"	SS
143894	10" x 14"	SS
143892	7" x 10"	PL
143891	10" x 14"	PL
143895	7" x 10"	AL
143893	10" x 14"	AL



143902	7" x 10"	SS
143900	10" x 14"	SS
143898	7" x 10"	PL
143897	10" x 14"	PL
143901	7" x 10"	AL
143899	10" x 14"	AL



143921	7" x 10"	SS
143920	10" x 14"	SS
143922	7" x 10"	PL
143923	10" x 14"	PL
143924	7" x 10"	AL
143925	10" x 14"	AL



144508	5" x 3-1/2"	SS
144504	7" x 5"	SS
144511	10" x 7"	SS
144506	14" x 10"	SS
144512	10" x 7"	PL
144509	14" x 10"	PL
144513	10" x 7"	AL
144510	14" x 10"	AL



144763	10" x 14"	FB
144764	7" x 10"	SS
144765	10" x 14"	SS
144766	7" x 10"	PL
144767	10" x 14"	PL
144768	7" x 10"	AL
144769	10" x 14"	AL



144789	7" x 10"	SS
144790	10" x 14"	SS
144785	7" x 10"	PL
144787	10" x 14"	PL
144786	7" x 10"	AL
144788	10" x 14"	AL



145265	7" x 10"	SS
145264	10" x 14"	SS
145262	7" x 10"	PL
145263	10" x 14"	PL
145267	7" x 10"	AL
145266	10" x 14"	AL



144093	7" x 10"	SS
144094	10" x 14"	SS
144091	7" x 10"	PL
144089	10" x 14"	PL
144092	7" x 10"	AL
144090	10" x 14"	AL



144095	7" x 17"	FB
--------	----------	----



144098	7" x 10"	SS
144099	10" x 14"	SS
144097	7" x 10"	PL
144096	10" x 14"	PL
144100	7" x 10"	AL
144101	10" x 14"	AL



143905	7" x 10"	SS
143906	10" x 14"	SS
143907	7" x 10"	PL
143908	10" x 14"	PL
143903	7" x 10"	AL
143904	10" x 14"	AL



144109	7" x 10"	SS
144110	10" x 14"	SS
144111	7" x 10"	PL
144108	10" x 14"	PL
144112	7" x 10"	AL
144113	10" x 14"	AL



83931	3-1/2" x 5"	SS
83756	7" x 10"	SS
21803	7" x 10"	PL
26578	10" x 14"	PL
46479	7" x 10"	AL
46756	10" x 14"	AL



144778	7" x 17"	FB
--------	----------	----



144773	10" x 14"	FB
144777	3-1/2" x 5"	SS
144775	7" x 10"	SS
144772	10" x 14"	SS
144774	7" x 10"	PL
144770	10" x 14"	PL
144776	7" x 10"	AL
144771	10" x 14"	AL



145279	7" x 10"	SS
145278	10" x 14"	SS
145276	7" x 10"	PL
145277	10" x 14"	PL
145275	7" x 10"	AL
145274	10" x 14"	AL



62816	10" x 14"	FB
83932	3-1/2" x 5"	SS
83757	7" x 10"	SS
21804	7" x 10"	PL
26579	10" x 14"	PL
46480	7" x 10"	AL
46757	10" x 14"	AL



145289	7" x 10"	SS
145288	10" x 14"	SS
145291	7" x 10"	PL
145290	10" x 14"	PL
145287	7" x 10"	AL
145286	10" x 14"	AL



# ANSI Signs

BradyID.com/s34

## ANSI Signs (Continued)



144780	7" x 10"	SS
144781	10" x 14"	SS
144779	7" x 10"	PL
144782	10" x 14"	PL
144783	7" x 10"	AL
144784	10" x 14"	AL



143910	10" x 14"	B-946
143909	14" x 10"	B-946



125912	10" x 7"	SS
125915	14" x 10"	SS
125911	10" x 7"	PL
125914	14" x 10"	PL
125910	10" x 7"	AL
125913	14" x 10"	AL



124213	10" x 7"	SS
124216	14" x 10"	SS
124212	10" x 7"	PL
124215	14" x 10"	PL
124211	10" x 7"	AL
124214	14" x 10"	AL

**Popular Sign Materials**

**FB** - Premium Fiberglass (B-120)  
**SS** - Self-Sticking Polyester (B-302)  
**BGSS** - BradyGlo™ Self-Sticking Polyester (B-324)  
**BGPL** - BradyGlo™ Plastic (B-347)  
**PL** - Plastic (B-401)  
**AL** - Aluminum (B-555)

*View all sign materials on page 25.*

**Can't find your sign?**  
*Use the Sign Legend Index on page 498 or take advantage of our custom sign options.*



128624	10" x 7"	SS
128627	14" x 10"	SS
128623	10" x 7"	PL
128626	14" x 10"	PL
128622	10" x 7"	AL
128625	14" x 10"	AL



144330	7" x 10"	SS
144331	10" x 14"	SS
144332	7" x 10"	PL
144333	10" x 14"	PL
144334	7" x 10"	AL
144335	10" x 14"	AL



45023	10" x 7"	FB
45024	14" x 10"	FB
45159	10" x 7"	SS
45091	10" x 7"	PL
45092	14" x 10"	PL
49011	10" x 7"	AL



143647	7" x 10"	SS
143648	10" x 14"	SS
143644	7" x 10"	PL
143646	10" x 14"	PL
143645	7" x 10"	AL
143643	10" x 14"	AL



143650	7" x 10"	SS
143649	10" x 14"	SS
143653	7" x 10"	PL
143651	10" x 14"	PL
143654	7" x 10"	AL
143652	10" x 14"	AL



144797	7" x 10"	SS
144798	10" x 14"	SS
144799	7" x 10"	PL
144800	10" x 14"	PL
144801	7" x 10"	AL
144802	10" x 14"	AL

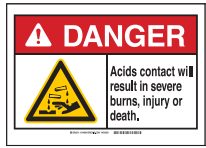

144803	7" x 10"	SS
144804	10" x 14"	SS
144805	7" x 10"	PL
144806	10" x 14"	PL
144807	7" x 10"	AL
144808	10" x 14"	AL



144813	7" x 10"	SS
144810	10" x 14"	SS
144814	7" x 10"	PL
144811	10" x 14"	PL
144812	7" x 10"	AL
144809	10" x 14"	AL



144341	7" x 10"	SS
144342	10" x 14"	SS
144343	7" x 10"	PL
144344	10" x 14"	PL
144345	7" x 10"	AL
144346	10" x 14"	AL



144821	20" x 14"	FB
144828	10" x 7"	SS
144825	14" x 10"	SS
144827	10" x 7"	PL
144824	14" x 10"	PL
144826	10" x 7"	AL
144823	14" x 10"	AL



144829	7" x 10"	SS
144830	10" x 14"	SS
144822	7" x 10"	PL
144851	10" x 14"	PL
144832	10" x 14"	AL



144850	7" x 10"	PL
144847	10" x 14"	AL



144593	10" x 14"	SS
144594	10" x 14"	PL
144596	10" x 14"	AL



144168	7" x 10"	SS
144169	10" x 14"	SS
144165	7" x 10"	PL
144164	10" x 14"	PL
144167	7" x 10"	AL
144166	10" x 14"	AL



144168	7" x 10"	SS
144169	10" x 14"	SS
144165	7" x 10"	PL
144164	10" x 14"	PL
144167	7" x 10"	AL
144166	10" x 14"	AL



144355	14" x 20"	FB
--------	-----------	----

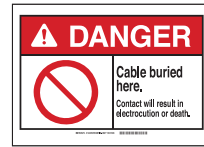

144358	7" x 10"	SS
144359	10" x 14"	SS
144360	7" x 10"	PL
144361	10" x 14"	PL
144357	7" x 10"	AL
144356	10" x 14"	AL



144852	7" x 10"	SS
144853	10" x 14"	SS
144854	7" x 10"	PL
144855	10" x 14"	PL
144856	7" x 10"	AL
144857	10" x 14"	AL



144865	10" x 14"	FB
144864	7" x 10"	SS
144866	10" x 14"	SS
144867	7" x 10"	PL
144868	10" x 14"	PL
144869	7" x 10"	AL
144870	10" x 14"	AL



144871	7" x 10"	SS
144872	10" x 14"	SS
144873	7" x 10"	PL
144874	10" x 14"	PL
144875	7" x 10"	AL
144876	10" x 14"	AL



144882	7" x 10"	FB
144878	10" x 14"	FB
144881	7" x 10"	SS
144879	10" x 14"	SS
144883	7" x 10"	PL
144877	10" x 14"	PL
144884	7" x 10"	AL
144880	10" x 14"	AL



144900	10" x 14"	FB
144899	10" x 14"	SS



144885	10" x 14"	FB
144887	7" x 10"	SS
144886	10" x 14"	SS
144888	7" x 10"	PL
144889	10" x 14"	PL
144890	7" x 10"	AL
144891	10" x 14"	AL



144913	7" x 10"	SS
144912	10" x 14"	SS
144914	7" x 10"	PL
144915	10" x 14"	PL
144916	7" x 10"	AL
144917	10" x 14"	AL



## ANSI Signs (Continued)



144926 7" x 10" SS  
144927 10" x 14" SS  
144924 7" x 10" PL  
144925 10" x 14" PL  
144928 7" x 10" AL  
144929 10" x 14" AL



143681 10" x 14" FB  
143679 10" x 14" SS  
143682 7" x 10" PL  
143660 10" x 14" PL  
143680 7" x 10" AL  
143655 10" x 14" AL



143656 7" x 10" SS  
143657 10" x 14" SS  
143659 7" x 10" PL  
143658 7" x 10" AL



122813 7" x 10" FB  
62866 10" x 14" FB  
83954 3-1/2" x 5" SS  
83839 7" x 10" SS  
21866 7" x 10" PL  
26591 10" x 14" PL  
46579 7" x 10" AL  
46819 10" x 14" AL



143667 10" x 14" FB  
143669 3-1/2" x 5" SS  
143662 7" x 10" SS  
143661 10" x 14" SS  
143668 7" x 10" PL  
143666 10" x 14" PL  
143665 7" x 10" AL  
143664 10" x 14" AL



44981 10" x 7" FB  
44982 14" x 10" FB  
45117 10" x 7" SS  
45118 14" x 10" SS  
45050 14" x 10" PL



143676 7" x 10" SS



143683 7" x 10" SS  
143684 10" x 14" SS  
143686 7" x 10" PL  
143685 10" x 14" PL  
143688 7" x 10" AL  
143687 10" x 14" AL



143689 7" x 10" SS  
143690 10" x 14" SS  
143692 7" x 10" PL  
143691 10" x 14" PL  
143694 7" x 10" AL  
143693 10" x 14" AL



143671 10" x 7" SS  
143670 14" x 10" SS  
143673 10" x 7" PL  
143672 14" x 10" PL  
143675 10" x 7" AL  
143674 14" x 10" AL



144612 7" x 10" SS  
144608 7" x 10" PL  
144611 7" x 10" AL



144609 10" x 14" FB  
144613 10" x 14" SS  
144607 10" x 14" PL  
144610 10" x 14" AL



143872 10" x 14" FB  
143874 7" x 10" SS  
143875 10" x 14" SS  
143873 7" x 10" PL  
143871 10" x 14" PL  
143876 7" x 10" AL  
143877 10" x 14" AL



45015 10" x 7" FB  
45151 10" x 7" SS  
45084 14" x 10" PL  
49003 10" x 7" AL  
49004 14" x 10" AL



144936 3-1/2" x 5" SS  
144937 7" x 10" SS  
144938 10" x 14" SS  
144939 7" x 10" PL  
144940 10" x 14" PL  
144941 7" x 10" AL  
144942 10" x 14" AL



144946 7" x 10" SS  
144943 10" x 14" SS  
144947 7" x 10" PL  
144944 10" x 14" PL  
144948 7" x 10" AL  
144945 10" x 14" AL



83896 3-1/2" x 5" SS  
83675 7" x 10" SS  
21723 7" x 10" PL  
26543 10" x 14" PL  
46641 7" x 10" AL



143946 7" x 10" SS  
143947 10" x 14" SS  
143945 7" x 10" PL  
143944 10" x 14" PL  
143948 7" x 10" AL  
143949 10" x 14" AL



144961 7" x 10" SS  
144967 10" x 14" SS  
144963 7" x 10" PL  
144964 10" x 14" PL  
144965 7" x 10" AL  
144966 10" x 14" AL



144971 10" x 14" FB  
144969 3-1/2" x 5" SS  
144968 7" x 10" SS  
144973 7" x 10" PL  
144972 10" x 14" PL  
144974 7" x 10" AL



144976 7" x 10" SS  
144975 10" x 14" SS  
144979 7" x 10" PL  
144980 10" x 14" PL  
144978 7" x 10" AL  
144977 10" x 14" AL



143754 7" x 10" SS  
143753 10" x 14" SS  
143755 7" x 10" PL  
143756 10" x 14" PL  
143757 7" x 10" AL  
143758 10" x 14" AL



143730 7" x 10" FB  
143738 7" x 10" SS  
143739 10" x 14" SS  
143737 7" x 10" PL  
143733 10" x 14" PL  
143735 7" x 10" AL  
143734 10" x 14" AL



143736 10" x 14" FB



# ANSI Signs

BradyID.com/s34

## ANSI Signs (Continued)

Safety Signs



144468 7" x 10" SS  
144469 10" x 14" SS  
144470 7" x 10" PL  
144471 10" x 14" PL  
144472 7" x 10" AL  
144467 10" x 14" AL



144308 7" x 10" SS  
144307 10" x 14" SS  
144187 7" x 10" PL  
144306 10" x 14" PL  
144310 7" x 10" AL  
144311 10" x 14" AL



144197 7" x 10" SS  
144199 10" x 14" SS  
144198 7" x 10" PL  
144196 10" x 14" PL  
144200 7" x 10" AL  
144201 10" x 14" AL



144204 10" x 14" FB  
144202 7" x 10" SS  
144205 10" x 14" SS  
144206 7" x 10" PL  
144203 10" x 14" PL  
144207 7" x 10" AL  
144208 10" x 14" AL

**Popular Sign Materials**

**FB** - Premium Fiberglass (B-120)  
**SS** - Self-Sticking Polyester (B-302)  
**BGSS** - BradyGlo™ Self-Sticking Polyester (B-324)  
**BGPL** - BradyGlo™ Plastic (B-347)  
**PL** - Plastic (B-401)  
**AL** - Aluminum (B-555)

*View all sign materials on page 25.*

**Can't find your sign?**  
*Use the Sign Legend Index on page 498 or take advantage of our custom sign options.*



143709 3-1/2" x 5" SS  
143713 7" x 10" SS  
143707 10" x 14" SS  
143711 7" x 10" PL  
143712 10" x 14" PL  
143710 7" x 10" AL  
143708 10" x 14" AL



144209 7" x 10" SS  
144210 10" x 14" SS  
144211 7" x 10" PL  
144212 10" x 14" PL  
144213 7" x 10" AL  
144214 10" x 14" AL



144220 7" x 10" SS  
144217 10" x 14" SS  
144218 7" x 10" PL  
144219 7" x 10" PL  
144216 10" x 14" PL



144473 7" x 5" B-811



62796 10" x 14" FB  
83912 3-1/2" x 5" SS  
83737 7" x 10" SS  
122573 10" x 14" SS  
21784 7" x 10" PL  
26559 10" x 14" PL  
46460 7" x 10" AL  
46737 10" x 14" AL



143911 3-1/2" x 5" SS



144230 7" x 10" SS  
144231 10" x 14" SS  
144229 7" x 10" PL  
144228 10" x 14" PL  
144232 7" x 10" AL  
144233 10" x 14" AL



144250 20" x 14" FB  
144255 7" x 10" PL  
144253 10" x 7" PL  
144251 14" x 10" PL  
144252 10" x 7" AL  
144248 14" x 10" AL



144249 7" x 10" SS  
144254 10" x 14" SS  
144256 10" x 14" PL  
144258 10" x 14" AL



144575 7" x 10" SS  
144577 10" x 14" SS  
144576 7" x 10" PL  
144574 10" x 14" PL  
144578 7" x 10" AL  
144579 10" x 14" AL



144458 3-1/2" x 5" SS  
144371 7" x 10" SS  
144369 10" x 14" SS  
144370 7" x 10" PL  
144368 10" x 14" PL  
144372 7" x 10" AL  
144373 10" x 14" AL

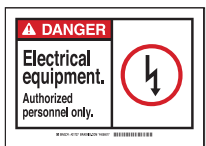

83900 3-1/2" x 5" SS  
83679 7" x 10" SS  
21727 7" x 10" PL  
26547 10" x 14" PL  
46645 7" x 10" AL  
46689 10" x 14" AL



143878 10" x 14" FB  
143879 7" x 10" SS  
143880 10" x 14" SS  
143881 7" x 10" PL  
143882 10" x 14" PL  
143883 7" x 10" AL  
143884 10" x 14" AL



144297 7" x 17" FB



144304 10" x 14" FB  
144309 7" x 10" PL



144362 7" x 10" SS  
144363 10" x 14" SS  
144364 7" x 10" PL  
144365 10" x 14" PL  
144366 7" x 10" AL  
144367 10" x 14" AL



144474 5" x 3-1/2" B-811  
144475 7" x 5" B-811  
144477 7" x 10" SS  
144478 10" x 14" SS  
144476 7" x 10" PL  
144479 10" x 14" PL  
144480 7" x 10" AL  
144481 10" x 14" AL



144982 10" x 14" FB  
144983 7" x 10" SS  
144981 10" x 14" SS  
144986 7" x 10" PL  
144987 10" x 14" PL  
144985 7" x 10" AL  
144984 10" x 14" AL



62797 10" x 14" FB  
83913 3-1/2" x 5" SS  
83738 7" x 10" SS  
60572 10" x 14" SS  
21785 7" x 10" PL  
26560 10" x 14" PL  
46461 7" x 10" AL  
46738 10" x 14" AL



144635 10" x 14" FB  
144621 3-1/2" x 5" SS  
144630 10" x 14" SS  
144619 10" x 14" PL  
144616 10" x 14" AL



144615 7" x 10" SS  
144622 10" x 14" SS  
144620 7" x 10" PL  
144634 10" x 14" PL  
144617 7" x 10" AL  
144632 10" x 14" AL



144374 7" x 10" SS  
144375 10" x 14" SS  
144376 7" x 10" PL  
144377 10" x 14" PL  
144378 7" x 10" AL  
144379 10" x 14" AL



144116 7" x 10" SS  
144117 10" x 14" SS  
144118 7" x 10" PL  
144114 10" x 14" PL  
144119 7" x 10" AL  
144120 10" x 14" AL



144116 7" x 10" SS  
144117 10" x 14" SS  
144118 7" x 10" PL  
144114 10" x 14" PL  
144119 7" x 10" AL  
144120 10" x 14" AL

## ANSI Signs (Continued)



144136 7" x 10" SS  
144137 10" x 14" SS  
144134 7" x 10" PL  
144135 10" x 14" PL  
144132 7" x 10" AL  
144133 10" x 14" AL



145015 10" x 14" FB  
145019 7" x 10" SS  
145014 10" x 14" SS  
145017 7" x 10" PL  
145016 10" x 14" PL  
145018 7" x 10" AL  
145000 10" x 14" AL



145020 10" x 14" SS  
145025 7" x 10" PL  
145024 10" x 14" PL  
145022 7" x 10" AL



145026 7" x 10" SS  
145031 10" x 14" AL  
145032 7" x 10" SS  
145034 10" x 14" SS  
145035 7" x 10" PL  
145036 7" x 10" AL  
145037 10" x 14" AL



83731 7" x 10" SS  
21778 7" x 10" PL  
26553 10" x 14" PL  
46454 7" x 10" AL  
46731 10" x 14" AL



145053 7" x 10" SS  
145041 10" x 14" SS  
145042 7" x 10" PL  
145040 10" x 14" PL  
145046 7" x 10" AL  
145038 10" x 14" AL



145045 10" x 14" SS



145055 10" x 14" FB  
145050 10" x 14" SS  
145056 7" x 10" PL  
145054 7" x 10" AL  
145051 10" x 14" AL



45019 10" x 7" FB  
45020 14" x 10" FB  
45155 10" x 7" SS  
45156 14" x 10" SS  
45087 10" x 7" PL  
45088 14" x 10" PL  
49008 14" x 10" AL



144997 7" x 10" SS  
144998 10" x 14" SS  
144999 7" x 10" PL  
144996 10" x 14" PL  
144995 7" x 10" AL  
144994 10" x 14" AL



62436 7" x 10" FB  
83902 3-1/2" x 5" SS  
83681 7" x 10" SS  
21729 7" x 10" PL  
26549 10" x 14" PL  
46647 7" x 10" AL  
46691 10" x 14" AL



145058 7" x 10" SS  
145060 10" x 14" SS  
145061 7" x 10" PL  
145057 10" x 14" PL  
145059 7" x 10" AL  
145062 10" x 14" AL



145063 10" x 14" FB  
145064 7" x 10" SS  
145065 10" x 14" SS  
145066 7" x 10" PL  
145067 10" x 14" PL  
145068 7" x 10" AL  
145069 10" x 14" AL



144153 10" x 14" FB  
144157 7" x 10" SS  
144154 10" x 14" SS  
144156 7" x 10" PL  
144152 10" x 14" PL  
144155 7" x 10" AL  
144151 10" x 14" AL



62794 10" x 14" FB  
83910 3-1/2" x 5" SS  
83735 7" x 10" SS  
60574 10" x 14" SS  
21782 7" x 10" PL  
26557 10" x 14" PL  
46458 7" x 10" AL  
46735 10" x 14" AL



144636 7" x 10" AL



145080 7" x 10" SS  
145081 10" x 14" SS  
145078 7" x 10" PL  
145112 10" x 14" PL  
145077 7" x 10" AL  
145076 10" x 14" AL



145084 7" x 10" FB  
145086 10" x 14" FB  
145085 7" x 10" PL  
145088 10" x 14" PL  
145087 7" x 10" AL  
145083 10" x 14" AL



145091 7" x 10" SS  
145108 10" x 14" SS  
145093 7" x 10" PL  
145095 7" x 10" AL  
145096 10" x 14" AL



145107 7" x 10" SS  
145103 7" x 10" PL  
145104 10" x 14" AL



145111 7" x 10" SS  
145110 10" x 14" SS  
145109 7" x 10" PL  
145114 7" x 10" AL  
145113 10" x 14" AL



144639 10" x 14" FB  
144642 7" x 10" SS  
144643 10" x 14" SS  
144638 7" x 10" PL  
144637 10" x 14" PL  
144641 7" x 10" AL  
144640 10" x 14" AL



62756 10" x 14" FB  
83901 3-1/2" x 5" SS  
83680 7" x 10" SS  
21728 7" x 10" PL  
26548 10" x 14" PL  
46646 7" x 10" AL  
46690 10" x 14" AL



145136 7" x 10" SS  
145137 10" x 14" SS  
145138 7" x 10" PL



145132 7" x 10" SS  
145133 10" x 14" SS  
145129 7" x 10" PL  
145139 10" x 14" PL  
145131 7" x 10" AL  
145130 10" x 14" AL

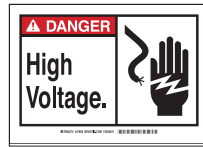

95772 7" x 10" FB  
62868 10" x 14" FB  
83956 3-1/2" x 5" SS  
83841 7" x 10" SS  
21868 7" x 10" PL  
26593 10" x 14" PL  
46581 7" x 10" AL  
46821 10" x 14" AL



45011 10" x 7" FB  
45012 14" x 10" FB  
45147 10" x 7" SS  
45148 14" x 10" SS  
45080 14" x 10" PL  
48999 10" x 7" AL



144406 14" x 20" FB



144412 7" x 10" SS  
144409 10" x 14" SS  
144411 7" x 10" PL  
144408 10" x 14" PL  
144410 7" x 10" AL  
144407 10" x 14" AL



# ANSI Signs

BradyID.com/s34

## ANSI Signs (Continued)

Safety Signs

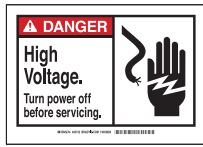

144383	7" x 10"	FB
144384	10" x 14"	FB
144386	2-1/4" x 4-1/2"	SS
144380	3-1/2" x 5"	SS
144381	7" x 10"	SS
144382	10" x 14"	SS
144389	7" x 10"	BGSS
144388	7" x 10"	PL
144385	10" x 14"	PL
144387	7" x 10"	AL



144415	7" x 17"	FB
--------	----------	----



144414	10" x 14"	FB
144413	7" x 10"	SS
144416	10" x 14"	SS
144417	7" x 10"	PL
144418	10" x 14"	PL
144419	7" x 10"	AL
144420	10" x 14"	AL



44992	14" x 10"	FB
45127	10" x 7"	SS
45059	10" x 7"	PL
45060	14" x 10"	PL
48979	10" x 7"	AL
48980	14" x 10"	AL

### Popular Sign Materials

- FB** - Premium Fiberglass (B-120)
- SS** - Self-Sticking Polyester (B-302)
- BGSS** - BradyGlo™ Self-Sticking Polyester (B-324)
- BGPL** - BradyGlo™ Plastic (B-347)
- PL** - Plastic (B-401)
- AL** - Aluminum (B-555)

View all sign materials on page 25.

### Can't find your sign?

Use the Sign Legend Index on page 498 or take advantage of our custom sign options.



144651	7" x 10"	FB
144645	10" x 14"	FB
144659	14" x 20"	FB
144648	3-1/2" x 5"	SS
144660	7" x 10"	SS
144661	10" x 14"	SS
144658	7" x 10"	PL
144657	10" x 14"	PL
144652	7" x 10"	AL
144644	10" x 14"	AL



144459	3-1/2" x 5"	SS
--------	-------------	----

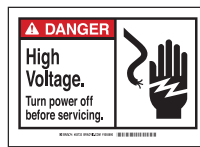

62791	10" x 14"	FB
83907	3-1/2" x 5"	SS
83732	7" x 10"	SS
46732	10" x 14"	AL



144398	10" x 7"	FB
144397	10" x 7"	SS
144401	14" x 10"	SS
144396	10" x 14"	BGSS
144404	7" x 10"	BGPL
144399	10" x 7"	PL
144402	14" x 10"	PL
144400	10" x 7"	AL
144405	10" x 14"	AL
144403	14" x 10"	AL



144460	3-1/2" x 5"	SS
144461	7" x 10"	SS
144462	10" x 14"	SS
144463	7" x 10"	PL
144464	10" x 14"	PL
144465	7" x 10"	AL
144466	10" x 14"	AL



144423	7" x 10"	SS
144426	10" x 14"	SS
144421	7" x 10"	PL
144424	10" x 14"	PL
144425	7" x 10"	AL
144422	10" x 14"	AL



62753	10" x 14"	FB
83898	3-1/2" x 5"	SS
83677	7" x 10"	SS
21725	7" x 10"	PL
26545	10" x 14"	PL
46643	7" x 10"	AL
46687	10" x 14"	AL



143841	7" x 10"	SS
143842	10" x 14"	SS
143843	7" x 10"	PL
143844	10" x 14"	PL
143840	7" x 10"	AL
143845	10" x 14"	AL



143852	7" x 17"	FB
--------	----------	----



143853	7" x 10"	SS
143854	10" x 14"	SS
143855	7" x 10"	PL
143856	10" x 14"	PL
143857	7" x 10"	AL
143858	10" x 14"	AL



143836	10" x 14"	FB
143801	3-1/2" x 5"	SS
143832	3-1/2" x 5"	SS
143809	7" x 10"	SS
143833	7" x 10"	SS
143810	10" x 14"	SS
143811	7" x 10"	PL
143835	7" x 10"	PL
143812	10" x 14"	PL
143837	10" x 14"	PL
143802	7" x 10"	AL
143831	7" x 10"	AL
143838	10" x 14"	AL



143815	10" x 14"	AL
--------	-----------	----



145140	7" x 10"	SS
145141	10" x 14"	SS
145144	7" x 10"	PL
145145	10" x 14"	PL
145143	7" x 10"	AL
145142	10" x 14"	AL



145147	10" x 14"	FB
145151	7" x 10"	SS
145152	10" x 14"	SS
145150	7" x 10"	PL
145148	10" x 14"	PL
145149	7" x 10"	AL
145146	10" x 14"	AL



145153	7" x 17"	FB
--------	----------	----



145158	7" x 10"	SS
145159	10" x 14"	SS
145156	7" x 10"	PL
145154	10" x 14"	PL
145157	7" x 10"	AL
145155	10" x 14"	AL



144662	7" x 10"	FB
144663	7" x 10"	SS
144664	10" x 14"	SS
144665	7" x 10"	PL
144666	10" x 14"	PL
144667	7" x 10"	AL
144668	10" x 14"	AL



144671	10" x 14"	FB
144675	7" x 10"	SS
144672	7" x 10"	PL
144670	10" x 14"	PL
144674	7" x 10"	AL
144669	10" x 14"	AL

## ANSI Signs (Continued)



44993	10" x 7"	FB
44994	14" x 10"	FB
45129	10" x 7"	SS



143973	7" x 10"	SS
143974	10" x 14"	SS
143971	7" x 10"	PL
143972	10" x 14"	PL
143970	7" x 10"	AL
143969	10" x 14"	AL



62530	7" x 10"	FB
62792	10" x 14"	FB
83908	3-1/2" x 5"	SS
83733	7" x 10"	SS
21780	7" x 10"	PL
26555	10" x 14"	PL
46733	10" x 14"	AL



144544	7" x 10"	SS
144545	10" x 14"	SS
144546	7" x 10"	PL
144547	10" x 14"	PL
144548	7" x 10"	AL
144549	10" x 14"	AL



144552	7" x 10"	SS
144555	10" x 14"	SS
144550	7" x 10"	PL
144553	10" x 14"	PL
144551	7" x 10"	AL
144554	10" x 14"	AL



145171	7" x 10"	SS
145172	10" x 14"	SS
145168	7" x 10"	PL
145167	10" x 14"	PL
145170	7" x 10"	AL
145169	10" x 14"	AL



144439	10" x 14"	FB
144440	7" x 10"	SS
144441	10" x 14"	SS
144442	7" x 10"	PL
144443	10" x 14"	PL
144444	7" x 10"	AL
144445	10" x 14"	AL



144482	7" x 10"	SS
144483	10" x 14"	SS
144484	7" x 10"	PL
144485	10" x 14"	PL
144486	7" x 10"	AL
144487	10" x 14"	AL



144490	7" x 10"	SS
144491	10" x 14"	SS
144492	7" x 10"	PL
144493	10" x 14"	PL
144488	7" x 10"	AL
144489	10" x 14"	AL



143975	10" x 14"	AL
--------	-----------	----



143976	10" x 14"	FB
143980	10" x 14"	SS
143979	7" x 10"	B-303
143981	7" x 10"	PL
143977	10" x 14"	PL
143982	7" x 10"	AL
143978	10" x 14"	AL



143984	7" x 10"	SS
143985	10" x 14"	SS
143986	7" x 10"	PL
143983	10" x 14"	PL
143987	7" x 10"	AL
143988	10" x 14"	AL



144007	7" x 10"	SS
144008	10" x 14"	SS
144006	7" x 10"	PL
144004	10" x 14"	PL
144003	7" x 10"	AL
144005	10" x 14"	AL



145174	14" x 20"	FB
145178	7" x 10"	SS
145179	10" x 14"	SS
145177	7" x 10"	PL
145176	10" x 14"	PL
145175	7" x 10"	AL
145173	10" x 14"	AL



144011	10" x 14"	FB
144010	20" x 14"	FB
144015	7" x 10"	SS
144016	10" x 14"	SS
144013	7" x 10"	PL
144009	10" x 14"	PL
144014	7" x 10"	AL
144012	10" x 14"	AL



144556	7" x 10"	SS
144558	10" x 14"	SS
144557	7" x 10"	PL
144559	10" x 14"	PL
144560	7" x 10"	AL
144561	10" x 14"	AL



144017	7" x 10"	SS
144020	10" x 14"	SS
144019	7" x 10"	PL
144022	10" x 14"	PL
144018	7" x 10"	AL
144021	10" x 14"	AL



145184	7" x 10"	SS
145185	10" x 14"	SS
145183	7" x 10"	PL
145182	10" x 14"	PL
145181	7" x 10"	AL



145188	7" x 10"	SS
145189	10" x 14"	SS
145187	7" x 10"	PL
145186	10" x 14"	PL
145191	7" x 10"	AL
145190	10" x 14"	AL



145194	7" x 10"	SS
145195	10" x 14"	SS
145192	7" x 10"	PL
145193	10" x 14"	PL
145197	7" x 10"	AL
145196	10" x 14"	AL



144516	7" x 10"	SS
144517	10" x 14"	SS
144518	7" x 10"	PL
144519	10" x 14"	PL
144515	7" x 10"	AL
144514	10" x 14"	AL



143762	10" x 14"	FB
143763	7" x 10"	SS
143760	10" x 14"	SS
143761	10" x 14"	PL
143764	7" x 10"	AL
143759	10" x 14"	AL



62827	10" x 14"	FB
83943	3-1/2" x 5"	SS
83768	7" x 10"	SS
21815	7" x 10"	PL
26590	10" x 14"	PL
46491	7" x 10"	AL
46768	10" x 14"	AL



143772	7" x 17"	FB
--------	----------	----



143774	10" x 14"	FB
143776	14" x 20"	FB
143777	7" x 10"	SS
143773	10" x 14"	SS
143780	7" x 10"	PL
143778	10" x 14"	PL
143779	7" x 10"	AL
143775	10" x 14"	AL



143783	10" x 14"	FB
143785	3-1/2" x 5"	SS
143784	7" x 10"	SS
143781	10" x 14"	SS
143787	7" x 10"	PL
143782	10" x 14"	PL
143786	7" x 10"	AL
143788	10" x 14"	AL



45123	10" x 7"	SS
45124	14" x 10"	SS
45055	10" x 7"	PL
45056	14" x 10"	PL
48975	10" x 7"	AL
48976	14" x 10"	AL

## Custom Signs

Brady's "Same as Stock" custom sign pricing makes it easy to create custom signs for your facility.

**View page 194 for more information.**



# ANSI Signs

BradyID.com/s34

## ANSI Signs (Continued)

Safety Signs



143791	7" x 10"	SS
143792	10" x 14"	SS
143793	7" x 10"	PL
143794	10" x 14"	PL
143790	7" x 10"	AL
143789	10" x 14"	AL



143795	7" x 10"	SS
143797	10" x 14"	SS
143796	7" x 10"	PL
143798	10" x 14"	PL
143799	7" x 10"	AL
143800	10" x 14"	AL



141913	10" x 7"	FB
141908	14" x 10"	FB
141914	10" x 7"	SS
141909	14" x 10"	SS
141917	10" x 7"	PL
141912	14" x 10"	PL
141915	10" x 7"	AL
141910	14" x 10"	AL
141916	10" x 7"	B-946
141911	14" x 10"	B-946



144686	7" x 10"	SS
144687	10" x 14"	SS
144684	7" x 10"	PL
144685	10" x 14"	PL
144682	7" x 10"	AL
144683	10" x 14"	AL

### Popular Sign Materials

- FB** - Premium Fiberglass (B-120)
- SS** - Self-Sticking Polyester (B-302)
- BGSS** - BradyGlo™ Self-Sticking Polyester (B-324)
- BGPL** - BradyGlo™ Plastic (B-347)
- PL** - Plastic (B-401)
- AL** - Aluminum (B-555)

View all sign materials on page 25.

### Can't find your sign?

Use the Sign Legend Index on page 498 or take advantage of our custom sign options.



144692	10" x 7"	SS
144693	14" x 10"	SS
144690	10" x 7"	PL
144691	14" x 10"	PL
144688	10" x 7"	AL
144689	14" x 10"	AL



143695	7" x 10"	SS
143696	10" x 14"	SS
143698	7" x 10"	PL
143697	10" x 14"	PL
143700	7" x 10"	AL
143699	10" x 14"	AL



145205	7" x 17"	FB
--------	----------	----



145206	7" x 10"	SS
145207	10" x 14"	SS
145208	7" x 10"	PL
145209	10" x 14"	PL
145210	7" x 10"	AL
145211	10" x 14"	AL



144730	7" x 10"	FB
144735	7" x 10"	SS
144736	10" x 14"	SS
144732	7" x 10"	PL
144731	10" x 14"	PL
144734	7" x 10"	AL
144733	10" x 14"	AL



144738	10" x 14"	FB
144740	7" x 10"	SS
144741	10" x 14"	SS
144742	7" x 10"	PL
144743	10" x 14"	PL
144739	7" x 10"	AL
144737	10" x 14"	AL



144746	7" x 10"	SS
144747	10" x 14"	SS
144745	7" x 10"	PL
144744	10" x 14"	PL
144748	7" x 10"	AL
144749	10" x 14"	AL



144456	7" x 10"	SS
144457	10" x 14"	SS
144455	7" x 10"	PL
144453	10" x 14"	PL
144454	7" x 10"	AL
144452	10" x 14"	AL



144568	7" x 10"	SS
144569	10" x 14"	SS
144570	7" x 10"	PL
144571	10" x 14"	PL
144572	7" x 10"	AL
144573	10" x 14"	AL



144034	7" x 10"	SS
144035	10" x 14"	SS
144032	7" x 10"	PL
144031	10" x 14"	PL
144033	7" x 10"	AL
144030	10" x 14"	AL



122829	7" x 10"	FB
122715	10" x 14"	FB
83911	3-1/2" x 5"	SS
83736	7" x 10"	SS
122574	10" x 14"	SS
21783	7" x 10"	PL
26558	10" x 14"	PL
46459	7" x 10"	AL
46736	10" x 14"	AL



143913	3-1/2" x 5"	SS
143914	7" x 10"	SS
143916	7" x 10"	PL
143918	7" x 10"	AL



145212	10" x 14"	FB
145213	7" x 10"	SS
145214	10" x 14"	SS
145215	7" x 10"	PL
145216	10" x 14"	PL
145217	7" x 10"	AL
145218	10" x 14"	AL



145229	7" x 10"	SS
145230	10" x 14"	SS
145227	7" x 10"	PL
145228	10" x 14"	PL
145231	7" x 10"	AL
145225	10" x 14"	AL



145233	10" x 14"	FB
145234	7" x 10"	SS



144698	7" x 10"	SS
144699	10" x 14"	SS
144696	7" x 10"	PL
144697	10" x 14"	PL
144695	7" x 10"	AL
144694	10" x 14"	AL



























144037	7" x 10"	FB
144036	7" x 10"	SS
144038	10" x 14"	SS
144042	7" x 10"	PL
144041	10" x 14"	PL
144039	7" x 10"	AL
144040	10" x 14"	AL



62433	7" x 10"	FB
62754	10" x 14"	FB
83899	3-1/2" x 5"	SS
83678	7" x 10"	SS
21726	7" x 10"	PL
26546	10" x 14"	PL
46644	7" x 10"	AL
46688	10" x 14"	AL

## ANSI Signs (Continued)

					
144049 7" x 17" FB	144043 7" x 10" SS 144044 10" x 14" SS 144045 7" x 10" PL 144046 10" x 14" PL 144047 7" x 10" AL 144048 10" x 14" AL	144051 7" x 10" SS 144052 10" x 14" SS 144053 7" x 10" PL 144050 10" x 14" PL 144054 7" x 10" AL 144055 10" x 14" AL	143927 7" x 10" SS 143929 10" x 14" SS 143926 7" x 10" PL 143928 10" x 14" PL 143930 7" x 10" AL 143931 10" x 14" AL	144057 7" x 10" SS 144056 10" x 14" SS 144058 7" x 10" PL 144059 10" x 14" PL 144060 7" x 10" AL 144061 10" x 14" AL	145250 7" x 10" SS 145251 10" x 14" SS 145254 7" x 10" PL 145255 10" x 14" PL 145253 7" x 10" AL 145252 10" x 14" AL
					
145257 7" x 10" SS 145256 10" x 14" SS 145260 7" x 10" PL 145261 10" x 14" PL 145259 7" x 10" AL 145258 10" x 14" AL	144700 7" x 10" SS 144701 10" x 14" SS 144702 7" x 10" PL 144703 10" x 14" PL 144705 10" x 14" AL	144062 7" x 10" SS 144063 10" x 14" SS 144064 7" x 10" PL 144065 10" x 14" PL 144066 7" x 10" AL 144067 10" x 14" AL	44983 10" x 7" FB 44984 14" x 10" FB 45119 10" x 7" SS 45052 14" x 10" PL 48972 14" x 10" AL	144074 7" x 10" FB 144068 10" x 14" FB 144071 3-1/2" x 5" SS 144070 10" x 14" SS 144076 7" x 10" PL 144073 10" x 14" PL 144075 7" x 10" AL 144069 10" x 14" AL	144077 7" x 10" SS 144078 10" x 14" SS 144079 7" x 10" PL 144080 10" x 14" PL 144081 7" x 10" AL 144082 10" x 14" AL
					
144581 7" x 10" PL 144580 7" x 10" AL	144710 7" x 10" SS 144711 10" x 14" SS 144707 7" x 10" PL 144706 10" x 14" PL 144708 7" x 10" AL 144709 10" x 14" AL	144083 7" x 10" SS 144084 10" x 14" SS 144085 7" x 10" PL 144086 10" x 14" PL 144087 7" x 10" AL 144088 10" x 14" AL	144584 7" x 10" SS 144585 10" x 14" SS 144586 7" x 10" PL 144587 10" x 14" PL 144583 7" x 10" AL 144582 10" x 14" AL	144106 7" x 10" SS 144107 10" x 14" SS 144105 7" x 10" PL 144103 10" x 14" PL 144104 7" x 10" AL 144102 10" x 14" AL	145269 7" x 10" SS 145268 10" x 14" SS 145272 7" x 10" PL 145273 10" x 14" PL 145271 7" x 10" AL 145270 10" x 14" AL
					
145283 7" x 10" SS 145282 10" x 14" SS 145281 7" x 10" PL 145280 10" x 14" PL 145285 7" x 10" AL 145284 10" x 14" AL	45021 10" x 7" FB 45022 14" x 10" FB 45157 10" x 7" SS 45158 14" x 10" SS 45089 10" x 7" PL 45090 14" x 10" PL 49009 10" x 7" AL 49010 14" x 10" AL	132218 7" x 10" FB 132219 10" x 14" FB 132220 7" x 10" SS 132221 10" x 14" SS 132214 7" x 10" PL 132215 10" x 14" PL 132216 7" x 10" AL 132217 10" x 14" AL	62557 7" x 10" FB 122753 10" x 14" FB 83935 3-1/2" x 5" SS 83760 7" x 10" SS 122612 10" x 14" SS 21807 7" x 10" PL 26582 10" x 14" PL 46483 7" x 10" AL 46760 10" x 14" AL	62818 10" x 14" FB 83934 3-1/2" x 5" SS 83759 7" x 10" SS 21806 7" x 10" PL 46482 7" x 10" AL 46759 10" x 14" AL	83936 3-1/2" x 5" SS 83761 7" x 10" SS 21808 7" x 10" PL 26583 10" x 14" PL 46484 7" x 10" AL 46761 10" x 14" AL



# ANSI Signs

BradyID.com/s34

## ANSI Signs (Continued)



62555	7" x 10"	FB
62817	10" x 14"	FB
83933	3-1/2" x 5"	SS
83758	7" x 10"	SS
21805	7" x 10"	PL
26580	10" x 14"	PL
46481	7" x 10"	AL
46758	10" x 14"	AL



62560	7" x 10"	FB
62822	10" x 14"	FB
83938	3-1/2" x 5"	SS
83763	7" x 10"	SS
21810	7" x 10"	PL
26585	10" x 14"	PL
46486	7" x 10"	AL
46763	10" x 14"	AL



44979	10" x 7"	FB
44980	14" x 10"	FB
45115	10" x 7"	SS
45116	14" x 10"	SS
45047	10" x 7"	PL
45048	14" x 10"	PL
48967	10" x 7"	AL
48968	14" x 10"	AL



83874	3-1/2" x 5"	SS
21700	7" x 10"	PL
26521	10" x 14"	PL
46661	10" x 14"	AL

**Popular Sign Materials**

- FB** - Premium Fiberglass (B-120)
- SS** - Self-Sticking Polyester (B-302)
- BGSS** - BradyGlo™ Self-Sticking Polyester (B-324)
- BGPL** - BradyGlo™ Plastic (B-347)
- PL** - Plastic (B-401)
- AL** - Aluminum (B-555)

*View all sign materials on page 25.*

**Can't find your sign?**  
Use the Sign Legend Index on page 498 or take advantage of our custom sign options.



62561	7" x 10"	FB
83939	3-1/2" x 5"	SS
83764	7" x 10"	SS
26586	10" x 14"	PL
46764	10" x 14"	AL



83658	7" x 10"	SS
21707	7" x 10"	PL
26528	10" x 14"	PL



83877	3-1/2" x 5"	SS
83654	7" x 10"	SS
21703	7" x 10"	PL
26524	10" x 14"	PL
46620	7" x 10"	AL
46664	10" x 14"	AL



45173	10" x 7"	SS
45105	10" x 7"	PL
45106	14" x 10"	PL
49026	14" x 10"	AL



45035	10" x 7"	FB
45171	10" x 7"	SS
45172	14" x 10"	SS
45103	10" x 7"	PL
45104	14" x 10"	PL
49024	14" x 10"	AL



45141	10" x 7"	SS
45073	10" x 7"	PL
45074	14" x 10"	PL



44985	10" x 7"	FB
45121	10" x 7"	SS
45122	14" x 10"	SS
45053	10" x 7"	PL
45054	14" x 10"	PL
48974	14" x 10"	AL



45001	10" x 7"	FB
45138	14" x 10"	SS
45069	10" x 7"	PL
48989	10" x 7"	AL
48990	14" x 10"	AL



45113	10" x 7"	SS
45045	10" x 7"	PL
48966	14" x 10"	AL



62810	10" x 14"	FB
83751	7" x 10"	SS
21798	7" x 10"	PL
26573	10" x 14"	PL
46474	7" x 10"	AL
46751	10" x 14"	AL



44999	10" x 7"	FB
45000	14" x 10"	FB
45136	14" x 10"	SS
45067	10" x 7"	PL
45068	14" x 10"	PL
48987	10" x 7"	AL
48988	14" x 10"	AL



126422	10" x 7"	SS
126425	14" x 10"	SS
126421	10" x 7"	PL
126424	14" x 10"	PL
126420	10" x 7"	AL
126423	14" x 10"	AL



132235	7" x 10"	FB
132236	10" x 14"	FB
132237	7" x 10"	SS
132238	10" x 14"	SS
132231	7" x 10"	PL
132232	10" x 14"	PL
132233	7" x 10"	AL
132234	10" x 14"	AL



132244	7" x 10"	FB
132245	10" x 14"	FB
132246	7" x 10"	SS
132247	10" x 14"	SS
132240	7" x 10"	PL
132241	10" x 14"	PL
132242	7" x 10"	AL
132243	10" x 14"	AL



45179	10" x 7"	SS
45180	10" x 7"	SS
45111	10" x 7"	PL
45112	14" x 10"	PL
49032	14" x 10"	AL



144605	7" x 10"	SS
144603	7" x 10"	PL
144602	7" x 10"	AL



45017	10" x 7"	FB
45018	14" x 10"	FB
45153	10" x 7"	SS
45154	14" x 10"	SS
45085	10" x 7"	PL
45086	14" x 10"	PL
49005	10" x 7"	AL
49006	10" x 14"	AL



144606	10" x 14"	SS
144604	10" x 14"	PL
144595	10" x 14"	AL



## ANSI Signs (Continued)



126506	7" x 10"	SS
126509	10" x 14"	SS
126505	7" x 10"	PL
126508	10" x 14"	PL
126504	7" x 10"	AL
126507	10" x 14"	AL



144955	7" x 10"	SS
144956	10" x 14"	SS
144957	7" x 10"	PL
144958	10" x 14"	PL
144959	7" x 10"	AL
144960	10" x 14"	AL



143728	7" x 10"	SS
143729	10" x 14"	SS
143725	7" x 10"	PL
143727	10" x 14"	PL
143724	7" x 10"	AL
143726	10" x 14"	AL



143963	7" x 10"	SS
143964	10" x 14"	SS
143965	7" x 10"	PL
143966	10" x 14"	PL
143967	7" x 10"	AL
143968	10" x 14"	AL



144623	7" x 10"	SS
144624	10" x 14"	SS
144625	7" x 10"	PL
144626	10" x 14"	PL
144627	7" x 10"	AL
144628	10" x 14"	AL



145099	7" x 10"	SS
145100	10" x 14"	SS
145101	7" x 10"	PL
145102	10" x 14"	PL
145097	7" x 10"	AL
145098	10" x 14"	AL



144390	7" x 10"	SS
144393	10" x 14"	SS
144391	7" x 10"	PL
144394	10" x 14"	PL
144392	7" x 10"	AL
144395	10" x 14"	AL



143824	7" x 10"	SS
143825	10" x 14"	SS
143826	7" x 10"	PL
143827	10" x 14"	PL
143823	7" x 10"	AL
143828	10" x 14"	AL



62423	7" x 10"	FB
62743	10" x 14"	FB
83892	3-1/2" x 5"	SS
83669	7" x 10"	SS
21718	7" x 10"	PL
26539	10" x 14"	PL
46679	10" x 14"	AL
46635	7" x 10"	AL



145162	10" x 14"	FB
145164	7" x 10"	SS
145161	10" x 14"	SS
145163	7" x 10"	PL
145160	10" x 14"	PL
145166	7" x 10"	AL
145165	10" x 14"	AL



45028	14" x 10"	FB
45163	10" x 7"	SS
45164	10" x 7"	SS
45095	10" x 7"	PL
45096	14" x 10"	PL
49015	10" x 7"	AL
49016	14" x 10"	AL



144680	7" x 10"	SS
144681	10" x 14"	SS
144678	7" x 10"	PL
144677	10" x 14"	PL
144679	7" x 10"	AL
144676	10" x 14"	AL



145248	7" x 10"	SS
145249	10" x 14"	SS
145246	7" x 10"	PL
145247	10" x 14"	PL
145245	7" x 10"	AL
145244	10" x 14"	AL



126494	10" x 7"	SS
126497	14" x 10"	SS
126493	10" x 7"	PL
126496	14" x 10"	PL
126492	10" x 7"	AL
126495	14" x 10"	AL



129026	10" x 7"	SS
129029	14" x 10"	SS
129025	10" x 7"	PL
129028	14" x 10"	PL
129024	10" x 7"	AL
129027	14" x 10"	AL



90175	14" x 10"	BGSS
90706	10" x 7"	BGPL



90707	10" x 7"	BGPL
90769	14" x 10"	BGPL



90692	10" x 7"	BGPL
-------	----------	------



45009	10" x 7"	FB
45145	10" x 7"	SS
45146	14" x 10"	SS
45077	10" x 7"	PL
45078	14" x 10"	PL
48998	14" x 10"	AL



83941	3-1/2" x 5"	SS
83766	7" x 10"	SS
21813	7" x 10"	PL
26588	10" x 14"	PL
46489	7" x 10"	AL
46766	10" x 14"	AL



83942	3-1/2" x 5"	SS
83767	7" x 10"	SS
21814	7" x 10"	PL
26589	10" x 14"	PL
46767	10" x 14"	AL

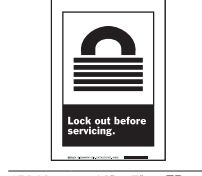

45013	10" x 7"	FB
45150	14" x 10"	SS
45081	10" x 7"	PL
45082	14" x 10"	PL
49001	10" x 7"	AL



44995	10" x 7"	FB
44996	14" x 10"	FB
45131	10" x 7"	SS
45132	14" x 10"	SS
45063	10" x 7"	PL
45064	14" x 10"	PL
48983	10" x 7"	AL
48984	14" x 10"	AL

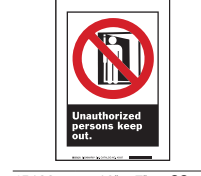

45133	10" x 7"	SS
45065	10" x 7"	PL



# Bilingual and Spanish-Only Signs

BradyID.com/s34

## Bilingual and Spanish-Only Signs

Brady has a full line of Bilingual and Spanish signs that communicate safety and facility information to your Spanish-speaking employees and visitors.

Brady Spanish signs provide your facility with the appropriate Spanish safety message such as "precaucion," "peligro," "seguridad primero," "aviso" and "advertencia."

### Popular Sign Materials

- FB** - Premium Fiberglass (B-120)
- SS** - Self-Sticking Polyester (B-302)
- BGSS** - BradyGlo™ Self-Sticking Polyester (B-324)
- BGPL** - BradyGlo™ Plastic (B-347)
- PL** - Plastic (B-401)
- AL** - Aluminum (B-555)

View all sign materials on page 25.



124051	10" x 7"	SS
124054	14" x 10"	SS
124050	10" x 7"	PL
124053	14" x 10"	PL
124049	10" x 7"	AL
124052	14" x 10"	AL



125393	10" x 7"	SS
125396	14" x 10"	SS
90514	14" x 10"	BGSS
125392	10" x 7"	PL
125395	14" x 10"	PL
125391	10" x 7"	AL
125394	14" x 10"	AL



125429	7" x 10"	SS
125432	10" x 14"	SS
125428	7" x 10"	PL
125431	10" x 14"	PL
125427	7" x 10"	AL
125430	10" x 14"	AL



125351	7" x 10"	SS
125354	10" x 14"	SS
125350	7" x 10"	PL
125353	10" x 14"	PL
125349	7" x 10"	AL
125352	10" x 14"	AL



125477	10" x 7"	SS
125480	14" x 10"	SS
125476	10" x 7"	PL
125479	14" x 10"	PL
125475	10" x 7"	AL
125478	14" x 10"	AL



125333	7" x 10"	SS
125336	10" x 14"	SS
125332	7" x 10"	PL
125335	10" x 14"	PL
125331	7" x 10"	AL
125334	10" x 14"	AL



125345	10" x 7"	SS
125348	14" x 10"	SS
90744	14" x 10"	BGPL
125344	10" x 7"	PL
125347	14" x 10"	PL
125343	10" x 7"	AL
125346	14" x 10"	AL



39850	7" x 10"	FB
38964	7" x 10"	PL
38984	10" x 14"	PL
38474	10" x 14"	AL



123997	10" x 7"	SS
124000	14" x 10"	SS
123996	10" x 7"	PL
123999	14" x 10"	PL
123995	10" x 7"	AL
123998	14" x 10"	AL



122807	7" x 10"	FB
122783	14" x 10"	FB
122645	7" x 10"	SS
90809	14" x 10"	SS
122512	7" x 10"	PL
38942	14" x 10"	PL
122401	7" x 10"	AL
38430	14" x 10"	AL



125339	10" x 7"	SS
125342	14" x 10"	SS
125338	10" x 7"	PL
125341	14" x 10"	PL
125337	10" x 7"	AL
125340	14" x 10"	AL



124913	7" x 10"	SS
124916	10" x 14"	SS
124912	7" x 10"	PL
124915	10" x 14"	PL
124911	7" x 10"	AL
124914	10" x 14"	AL



39738	20" x 14"	FB
90816	14" x 10"	SS
38846	14" x 10"	PL
38345	14" x 10"	AL



124057	10" x 7"	SS
124060	14" x 10"	SS
124056	10" x 7"	PL
124059	14" x 10"	PL
124055	10" x 7"	AL
124058	14" x 10"	AL



125357	10" x 7"	SS
125360	14" x 10"	SS
125356	10" x 7"	PL
125359	14" x 10"	PL
125355	10" x 7"	AL
125358	14" x 10"	AL



125465	10" x 7"	SS
125468	14" x 10"	SS
125464	10" x 7"	PL
125467	14" x 10"	PL
125463	10" x 7"	AL
125466	14" x 10"	AL



125363	10" x 7"	SS
125366	14" x 10"	SS
125362	10" x 7"	PL
125365	14" x 10"	PL
125361	10" x 7"	AL
125364	14" x 10"	AL



125459	10" x 7"	SS
125462	14" x 10"	SS
125458	10" x 7"	PL
125461	14" x 10"	PL
125457	10" x 7"	AL
125460	14" x 10"	AL



125405	10" x 7"	SS
125408	14" x 10"	SS
125404	10" x 7"	PL
125407	14" x 10"	PL
125403	10" x 7"	AL
125406	14" x 10"	AL



125399	10" x 7"	SS
125402	14" x 10"	SS
125398	10" x 7"	PL
125401	14" x 10"	PL
125397	10" x 7"	AL
125400	14" x 10"	AL



125369	10" x 7"	SS
125372	14" x 10"	SS
125368	10" x 7"	PL
125371	14" x 10"	PL
125367	10" x 7"	AL
125370	14" x 10"	AL



125417	10" x 7"	SS
125420	14" x 10"	SS
125416	10" x 7"	PL
125419	14" x 10"	PL
125415	10" x 7"	AL
125418	14" x 10"	AL

# Bilingual and Spanish-Only Signs

BradyID.com/s34

## Bilingual and Spanish-Only Signs (Continued)



125375	10" x 7"	SS
125378	14" x 10"	SS
125374	10" x 7"	PL
125377	14" x 10"	PL
125373	10" x 7"	AL
125376	14" x 10"	AL



125327	7" x 10"	SS
125330	10" x 14"	SS
125326	7" x 10"	PL
125329	10" x 14"	PL
125325	7" x 10"	AL
125328	10" x 14"	AL



124919	7" x 10"	SS
124922	10" x 14"	SS
124918	7" x 10"	PL
124921	10" x 14"	PL
124917	7" x 10"	AL
124920	10" x 14"	AL



125411	10" x 7"	SS
125414	14" x 10"	SS
125410	10" x 7"	PL
125413	14" x 10"	PL
125409	10" x 7"	AL
125412	14" x 10"	AL



125453	10" x 7"	SS
125456	14" x 10"	SS
125452	10" x 7"	PL
125455	14" x 10"	PL
125451	10" x 7"	AL
125454	14" x 10"	AL



125387	7" x 10"	SS
125390	10" x 14"	SS
125386	7" x 10"	PL
125389	10" x 14"	PL
125385	7" x 10"	AL
125388	10" x 14"	AL



125381	7" x 10"	SS
125384	10" x 14"	SS
125380	7" x 10"	PL
125383	10" x 14"	PL
125379	7" x 10"	AL
125382	10" x 14"	AL



125471	10" x 7"	SS
125474	14" x 10"	SS
125470	10" x 7"	PL
125473	14" x 10"	PL
125469	10" x 7"	AL
125472	14" x 10"	AL



124931	7" x 10"	SS
124934	10" x 14"	SS
124930	7" x 10"	PL
124933	10" x 14"	PL
124929	7" x 10"	AL
124932	10" x 14"	AL



125483	10" x 7"	SS
125486	14" x 10"	SS
125482	10" x 7"	PL
125485	14" x 10"	PL
125481	10" x 7"	AL
125484	14" x 10"	AL



125447	10" x 7"	SS
125450	14" x 10"	SS
125446	10" x 7"	PL
125449	14" x 10"	PL
125445	10" x 7"	AL
125448	14" x 10"	AL



39965	20" x 14"	FB
90817	14" x 10"	SS
39085	14" x 10"	PL
38585	14" x 10"	AL



39149	10" x 14"	PL
37847	10" x 14"	AL



125321	7" x 10"	SS
125324	10" x 14"	SS
125320	7" x 10"	PL
125323	10" x 14"	PL
125319	7" x 10"	AL
125322	10" x 14"	AL



124925	7" x 10"	SS
124928	10" x 14"	SS
124924	7" x 10"	PL
124927	10" x 14"	PL
124923	7" x 10"	AL
124926	10" x 14"	AL



125441	10" x 7"	SS
125444	14" x 10"	SS
125440	10" x 7"	PL
125443	14" x 10"	PL
125439	10" x 7"	AL
125442	14" x 10"	AL



122805	7" x 10"	FB
122781	14" x 10"	FB
122643	7" x 10"	SS
90818	14" x 10"	SS
122510	7" x 10"	PL
39086	14" x 10"	PL
122399	7" x 10"	AL
38586	14" x 10"	AL



39173	10" x 14"	FB
39123	7" x 10"	PL
39150	10" x 14"	PL
37848	10" x 14"	AL



39991	7" x 10"	FB
39171	10" x 14"	FB
37803	7" x 10"	SS
39121	7" x 10"	PL
39148	10" x 14"	PL



122806	7" x 10"	FB
122782	14" x 10"	FB
39964	20" x 14"	FB
122644	7" x 10"	SS
90799	14" x 10"	SS
122511	7" x 10"	PL
39084	14" x 10"	PL
122400	7" x 10"	AL
122391	14" x 10"	AL



125435	10" x 7"	SS
125438	14" x 10"	SS
125434	10" x 7"	PL
125437	14" x 10"	PL
125433	10" x 7"	AL
125436	14" x 10"	AL

Safety Signs



# Bilingual and Spanish-Only Signs

BradyID.com/s34

## Bilingual and Spanish-Only Signs (Continued)

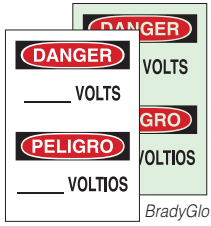

90743 14" x 10" BGPL  
38683 14" x 10" PL



39605 10" x 14" FB  
37635 7" x 10" SS  
38734 10" x 14" PL



90820 14" x 10" SS  
38684 14" x 10" PL



39606 10" x 14" FB  
37636 7" x 10" SS  
38711 7" x 10" PL  
38205 7" x 10" AL

**Popular Sign Materials**

- FB - Premium Fiberglass (B-120)
- SS - Self-Sticking Polyester (B-302)
- BGSS - BradyGlo™ Self-Sticking Polyester (B-324)
- BGPL - BradyGlo™ Plastic (B-347)
- PL - Plastic (B-401)
- AL - Aluminum (B-555)

View all sign materials on page 25.



125135 10" x 7" SS  
125138 14" x 10" SS  
125134 10" x 7" PL  
125137 14" x 10" PL  
125133 10" x 7" AL  
125136 14" x 10" AL



125129 7" x 10" SS  
125132 10" x 14" SS  
125128 7" x 10" PL  
125131 10" x 14" PL  
125127 7" x 10" AL  
125130 10" x 14" AL



125147 10" x 7" SS  
125150 14" x 10" SS  
90655 10" x 7" BGPL  
90737 14" x 10" BGPL  
125146 10" x 7" PL  
125149 14" x 10" PL  
125145 10" x 7" AL  
125148 14" x 10" AL



39579 20" x 14" FB  
90797 14" x 10" SS  
38679 14" x 10" PL  
38175 14" x 10" AL



39590 7" x 10" FB  
39601 10" x 14" FB  
37631 7" x 10" SS  
38706 7" x 10" PL  
38730 10" x 14" PL  
38200 7" x 10" AL  
38227 10" x 14" AL

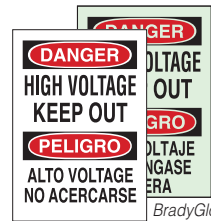

39506 20" x 14" FB  
90793 14" x 10" SS  
90147 10" x 7" BGSS  
90509 14" x 10" BGSS  
90658 10" x 7" BGPL  
90740 14" x 10" BGPL  
38606 14" x 10" PL  
38106 14" x 10" AL



39531 7" x 10" FB  
39556 10" x 14" FB  
37606 7" x 10" SS  
38656 10" x 14" PL  
38152 10" x 14" AL



122804 7" x 10" FB  
122780 14" x 10" FB  
39967 20" x 14" FB  
122642 7" x 10" SS  
90803 14" x 10" SS  
122509 7" x 10" PL  
39087 14" x 10" PL  
122398 7" x 10" AL  
38587 14" x 10" AL



39505 20" x 14" FB  
90542 14" x 10" SS  
38605 14" x 10" PL  
38105 14" x 10" AL



39555 10" x 14" FB  
38630 7" x 10" PL  
38655 10" x 14" PL  
38127 7" x 10" AL  
38151 10" x 14" AL



125309 10" x 7" SS  
125312 14" x 10" SS  
125308 10" x 7" PL  
125311 14" x 10" PL  
125307 10" x 7" AL  
125310 14" x 10" AL



125159 10" x 7" SS  
125162 14" x 10" SS  
125158 10" x 7" PL  
125161 14" x 10" PL  
125157 10" x 7" AL  
125160 14" x 10" AL



125165 10" x 7" SS  
125168 14" x 10" SS  
125164 10" x 7" PL  
125167 14" x 10" PL  
125163 10" x 7" AL  
125166 14" x 10" AL



124087 10" x 7" SS  
124090 14" x 10" SS  
124086 10" x 7" PL  
124089 14" x 10" PL  
124085 10" x 7" AL  
124088 14" x 10" AL



125117 7" x 10" SS  
125120 10" x 14" SS  
125116 7" x 10" PL  
125119 10" x 14" PL  
125115 7" x 10" AL  
125118 10" x 14" AL



124099 10" x 7" SS  
124102 14" x 10" SS  
124098 10" x 7" PL  
124101 14" x 10" PL  
124097 10" x 7" AL  
124100 14" x 10" AL



125261 10" x 7" SS  
125264 14" x 10" SS  
125260 10" x 7" PL  
125263 14" x 10" PL  
125259 10" x 7" AL  
125262 14" x 10" AL



124937 7" x 10" SS  
124940 10" x 14" SS  
124936 7" x 10" PL  
124939 10" x 14" PL  
124935 7" x 10" AL  
124938 10" x 14" AL

Safety Signs

# Bilingual and Spanish-Only Signs

BradyID.com/s34

## Bilingual and Spanish-Only Signs (Continued)



124081	10" x 7"	SS
124084	14" x 10"	SS
124080	10" x 7"	PL
124083	14" x 10"	PL
124079	10" x 7"	AL
124082	14" x 10"	AL



38865	14" x 10"	PL
38360	14" x 10"	AL



39780	7" x 10"	FB
39804	14" x 10"	FB
37718	7" x 10"	SS
124072	10" x 14"	SS
38892	7" x 10"	PL
124071	10" x 14"	PL
38383	7" x 10"	AL
38403	10" x 14"	AL



125201	10" x 7"	SS
125204	14" x 10"	SS
125200	10" x 7"	PL
125203	14" x 10"	PL
125199	10" x 7"	AL
125202	14" x 10"	AL



125153	10" x 7"	SS
125156	14" x 10"	SS
125152	10" x 7"	PL
125155	14" x 10"	PL
125151	10" x 7"	AL
125154	14" x 10"	AL



39978	7" x 10"	FB
37790	7" x 10"	SS
39108	7" x 10"	PL
39135	10" x 14"	PL
37833	10" x 14"	AL



124015	10" x 7"	SS
124018	14" x 10"	SS
124014	10" x 7"	PL
124017	14" x 10"	PL
124013	10" x 7"	AL
124016	14" x 10"	AL



39658	20" x 14"	FB
38767	14" x 10"	PL
38264	14" x 10"	AL



125243	10" x 7"	SS
125246	14" x 10"	SS
125242	10" x 7"	PL
125245	14" x 10"	PL
125241	10" x 7"	AL
125244	14" x 10"	AL



125267	10" x 7"	SS
125270	14" x 10"	SS
125266	10" x 7"	PL
125269	14" x 10"	PL
125265	10" x 7"	AL
125268	14" x 10"	AL



124063	10" x 7"	SS
124066	14" x 10"	SS
124062	10" x 7"	PL
124065	14" x 10"	PL
124061	10" x 7"	AL
124064	14" x 10"	AL



39576	20" x 14"	FB
90543	14" x 10"	SS
38676	14" x 10"	PL
38172	14" x 10"	AL



124943	7" x 10"	SS
124946	10" x 14"	SS
124942	7" x 10"	PL
124945	10" x 14"	PL
124941	7" x 10"	AL
124944	10" x 14"	AL



125207	10" x 7"	SS
125210	14" x 10"	SS
125206	10" x 7"	PL
125209	14" x 10"	PL
125205	10" x 7"	AL
125208	14" x 10"	AL



50270	7" x 10"	PL
-------	----------	----



125105	7" x 10"	SS
125108	10" x 14"	SS
125104	7" x 10"	PL
125107	10" x 14"	PL
125103	7" x 10"	AL
125106	10" x 14"	AL



125099	7" x 10"	SS
125102	10" x 14"	SS
125098	7" x 10"	PL
125101	10" x 14"	PL
125097	7" x 10"	AL
125100	10" x 14"	AL



124949	7" x 10"	SS
124952	10" x 14"	SS
39124	7" x 10"	PL
39151	10" x 14"	PL
124947	7" x 10"	AL
37849	10" x 14"	AL



124093	10" x 7"	SS
124096	14" x 10"	SS
124092	10" x 7"	PL
124095	14" x 10"	PL
124091	10" x 7"	AL
124094	14" x 10"	AL



124105	10" x 7"	SS
124108	14" x 10"	SS
124104	10" x 7"	PL
124107	14" x 10"	PL
124103	10" x 7"	AL
124106	14" x 10"	AL



124141	10" x 7"	SS
124144	14" x 10"	SS
124140	10" x 7"	PL
124143	14" x 10"	PL
124139	10" x 7"	AL
124142	14" x 10"	AL



39811	20" x 14"	FB
90795	14" x 10"	SS
38920	14" x 10"	PL
38411	14" x 10"	AL



39833	7" x 10"	FB
37725	7" x 10"	SS
38457	10" x 14"	AL



# Bilingual and Spanish-Only Signs

BradyID.com/s34

## Bilingual and Spanish-Only Signs (Continued)



125213	10" x 7"	SS
125216	14" x 10"	SS
125212	10" x 7"	PL
125215	14" x 10"	PL
125211	10" x 7"	AL
125214	14" x 10"	AL



125291	10" x 7"	SS
125294	14" x 10"	SS
125290	10" x 7"	PL
125293	14" x 10"	PL
125289	10" x 7"	AL
125292	14" x 10"	AL



90143	10" x 7"	BGSS
90654	10" x 7"	BGPL
90736	14" x 10"	BGPL



124123	10" x 7"	SS
124126	14" x 10"	SS
124122	10" x 7"	PL
124125	14" x 10"	PL
124121	10" x 7"	AL
124124	14" x 10"	AL

**Popular Sign Materials**

- FB - Premium Fiberglass (B-120)
- SS - Self-Sticking Polyester (B-302)
- BGSS - BradyGlo™ Self-Sticking Polyester (B-324)
- BGPL - BradyGlo™ Plastic (B-347)
- PL - Plastic (B-401)
- AL - Aluminum (B-555)

View all sign materials on page 25.



39951	20" x 14"	FB
39071	14" x 10"	PL
38571	14" x 10"	AL



125171	10" x 7"	SS
125174	14" x 10"	SS
125170	10" x 7"	PL
125173	14" x 10"	PL
125169	10" x 7"	AL
125172	14" x 10"	AL



125285	7" x 10"	SS
125288	10" x 14"	SS
125284	7" x 10"	PL
125287	10" x 14"	PL
125283	7" x 10"	AL
125286	10" x 14"	AL



125279	7" x 10"	SS
125282	10" x 14"	SS
125278	7" x 10"	PL
125281	10" x 14"	PL
125277	7" x 10"	AL
125280	10" x 14"	AL



124955	7" x 10"	SS
124958	10" x 14"	SS
124954	7" x 10"	PL
124957	10" x 14"	PL
124953	7" x 10"	AL
124956	10" x 14"	AL



125297	10" x 7"	SS
125300	14" x 10"	SS
125296	10" x 7"	PL
125299	14" x 10"	PL
125295	10" x 7"	AL
125298	14" x 10"	AL



125249	10" x 7"	SS
125252	14" x 10"	SS
125248	10" x 7"	PL
125251	14" x 10"	PL
125247	10" x 7"	AL
125250	14" x 10"	AL



39758	20" x 14"	FB
90819	14" x 10"	SS
38866	14" x 10"	PL
38361	14" x 10"	AL



37719	7" x 10"	SS
38893	7" x 10"	PL
38384	7" x 10"	AL
38404	10" x 14"	AL



124961	7" x 10"	SS
124964	10" x 14"	SS
124960	7" x 10"	PL
124963	10" x 14"	PL
124959	7" x 10"	AL
124962	10" x 14"	AL



125255	10" x 7"	SS
125258	14" x 10"	SS
125254	10" x 7"	PL
125257	14" x 10"	PL
125253	10" x 7"	AL
125256	14" x 10"	AL



125273	10" x 7"	SS
125276	14" x 10"	SS
125272	10" x 7"	PL
125275	14" x 10"	PL
125271	10" x 7"	AL
125274	14" x 10"	AL



124075	10" x 7"	SS
124078	14" x 10"	SS
124074	10" x 7"	PL
124077	14" x 10"	PL
124073	10" x 7"	AL
124076	14" x 10"	AL



125231	10" x 7"	SS
125234	14" x 10"	SS
90507	14" x 10"	BGSS
90656	10" x 7"	BGPL
125230	10" x 7"	PL
125233	14" x 10"	PL
125229	10" x 7"	AL
125232	14" x 10"	AL



125183	10" x 7"	SS
125186	14" x 10"	SS
125182	10" x 7"	PL
125185	14" x 10"	PL
125181	10" x 7"	AL
125184	14" x 10"	AL



125177	10" x 7"	SS
125180	14" x 10"	SS
125176	10" x 7"	PL
125179	14" x 10"	PL
125175	10" x 7"	AL
125178	14" x 10"	AL



39503	20" x 14"	FB
38603	14" x 10"	PL
38103	14" x 10"	AL

Safety Signs

# Bilingual and Spanish-Only Signs

BradyID.com/s34

## Bilingual and Spanish-Only Signs (Continued)



39528	7" x 10"	FB
39553	14" x 10"	FB
37603	7" x 10"	SS
38628	7" x 10"	PL
38653	10" x 14"	PL



125237	10" x 7"	SS
125240	14" x 10"	SS
125236	10" x 7"	PL
125239	14" x 10"	PL
125235	10" x 7"	AL
125238	14" x 10"	AL



124117	10" x 7"	SS
124120	14" x 10"	SS
124116	10" x 7"	PL
124119	14" x 10"	PL
124115	10" x 7"	AL
124118	14" x 10"	AL



39504	20" x 14"	FB
90810	14" x 10"	SS
90734	14" x 10"	BGPL
38604	14" x 10"	PL
38104	14" x 10"	AL



39529	7" x 10"	FB
39554	10" x 14"	FB
37604	7" x 10"	SS
38629	7" x 10"	PL
38654	10" x 14"	PL
38150	10" x 14"	AL



122803	7" x 10"	FB
122779	14" x 10"	FB
39876	20" x 14"	FB
122641	7" x 10"	SS
90666	14" x 10"	SS
122508	7" x 10"	PL
38990	14" x 10"	PL
122397	7" x 10"	AL
38478	14" x 10"	AL



39894	7" x 10"	FB
39912	10" x 14"	FB
37758	7" x 10"	SS
39008	7" x 10"	PL
39026	10" x 14"	PL
38514	10" x 14"	AL



39817	20" x 14"	FB
38928	14" x 10"	PL
38417	14" x 10"	AL



39860	14" x 10"	FB
37737	7" x 10"	SS
38973	10" x 14"	PL
38440	7" x 10"	AL
38463	10" x 14"	AL



125315	10" x 7"	SS
125318	14" x 10"	SS
125314	10" x 7"	PL
125317	14" x 10"	PL
125313	10" x 7"	AL
125316	14" x 10"	AL



125189	7" x 10"	SS
125192	10" x 14"	SS
125188	7" x 10"	PL
125191	10" x 14"	PL
125187	7" x 10"	AL
125190	10" x 14"	AL



38867	14" x 10"	PL
38362	14" x 10"	AL



37720	7" x 10"	SS
-------	----------	----



124147	10" x 7"	SS
124150	14" x 10"	SS
124146	10" x 7"	PL
124149	14" x 10"	PL
124145	10" x 7"	AL
124148	14" x 10"	AL



125123	7" x 10"	SS
125126	10" x 14"	SS
125122	7" x 10"	PL
125125	10" x 14"	PL
125121	7" x 10"	AL
125124	10" x 14"	AL



125141	7" x 10"	SS
125144	10" x 14"	SS
125140	7" x 10"	PL
125143	10" x 14"	PL
125139	7" x 10"	AL
125142	10" x 14"	AL



125195	10" x 7"	SS
125198	14" x 10"	SS
125194	10" x 7"	PL
125197	14" x 10"	PL
125193	10" x 7"	AL
125196	14" x 10"	AL



125219	10" x 7"	SS
125222	14" x 10"	SS
125218	10" x 7"	PL
125221	14" x 10"	PL
125217	10" x 7"	AL
125220	14" x 10"	AL



124045	10" x 7"	SS
124048	14" x 10"	SS
124044	10" x 7"	PL
124047	14" x 10"	PL
124043	10" x 7"	AL
124046	14" x 10"	AL



39954	20" x 14"	FB
90657	10" x 7"	BGPL
39074	14" x 10"	PL
38574	14" x 10"	AL



39981	7" x 10"	FB
39161	14" x 10"	FB
37793	7" x 10"	SS
39111	7" x 10"	PL
39138	10" x 14"	PL
37809	7" x 10"	AL



39756	20" x 14"	FB
38864	14" x 10"	PL
38359	14" x 10"	AL



39803	14" x 10"	FB
38914	10" x 14"	PL



125111	7" x 10"	SS
125114	10" x 14"	SS
125110	7" x 10"	PL
125113	10" x 14"	PL
125109	7" x 10"	AL
125112	10" x 14"	AL

Safety Signs



# Bilingual and Spanish-Only Signs

BradyID.com/s34

## Bilingual and Spanish-Only Signs (Continued)



125303	10" x 7"	SS
125306	14" x 10"	SS
125302	10" x 7"	PL
125305	14" x 10"	PL
125301	10" x 7"	AL
125304	14" x 10"	AL



90149	10" x 7"	BGSS
90680	10" x 7"	BGPL



124009	10" x 7"	SS
124012	14" x 10"	SS
124008	10" x 7"	PL
124011	14" x 10"	PL
124007	10" x 7"	AL
124010	14" x 10"	AL



125495	7" x 10"	SS
125498	10" x 14"	SS
125494	7" x 10"	PL
125497	10" x 14"	PL
125493	7" x 10"	AL
125496	10" x 14"	AL

### Popular Sign Materials

- FB** - Premium Fiberglass (B-120)
- SS** - Self-Sticking Polyester (B-302)
- BGSS** - BradyGlo™ Self-Sticking Polyester (B-324)
- BGPL** - BradyGlo™ Plastic (B-347)
- PL** - Plastic (B-401)
- AL** - Aluminum (B-555)

View all sign materials on page 25.



39961	20" x 14"	FB
90674	14" x 10"	SS
39081	14" x 10"	PL
38581	14" x 10"	AL



37800	7" x 10"	SS
39145	10" x 14"	PL
37843	10" x 14"	AL



125063	10" x 7"	SS
125066	14" x 10"	SS
125062	10" x 7"	PL
125065	14" x 10"	PL
125061	10" x 7"	AL
125064	14" x 10"	AL



124997	10" x 7"	SS
125000	14" x 10"	SS
124996	10" x 7"	PL
124999	14" x 10"	PL
124995	10" x 7"	AL
124998	14" x 10"	AL



124979	10" x 7"	SS
124982	14" x 10"	SS
124978	10" x 7"	PL
124981	14" x 10"	PL
124977	10" x 7"	AL
124980	14" x 10"	AL



124991	10" x 7"	SS
124994	14" x 10"	SS
124990	10" x 7"	PL
124993	14" x 10"	PL
124989	10" x 7"	AL
124992	14" x 10"	AL



125033	10" x 7"	SS
125036	14" x 10"	SS
125032	10" x 7"	PL
125035	14" x 10"	PL
125031	10" x 7"	AL
125034	14" x 10"	AL



124033	10" x 7"	SS
124036	14" x 10"	SS
124032	10" x 7"	PL
124035	14" x 10"	PL
124031	10" x 7"	AL
124034	14" x 10"	AL



125069	10" x 7"	SS
125072	14" x 10"	SS
125068	10" x 7"	PL
125071	14" x 10"	PL
125067	10" x 7"	AL
125070	14" x 10"	AL

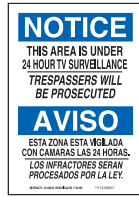

124039	10" x 7"	SS
124042	14" x 10"	SS
124038	10" x 7"	PL
124041	14" x 10"	PL
124037	10" x 7"	AL
124040	14" x 10"	AL



125009	7" x 10"	SS
125012	10" x 14"	SS
125008	7" x 10"	PL
125011	10" x 14"	PL
125007	7" x 10"	AL
125010	10" x 14"	AL



14216	14" x 10"	SS
14218	14" x 10"	PL
14219	14" x 10"	AL



122809	7" x 10"	FB
122785	14" x 10"	FB
122647	7" x 10"	SS
90807	14" x 10"	SS
122514	7" x 10"	PL
38937	14" x 10"	PL
122403	7" x 10"	AL
38425	14" x 10"	AL



37748	7" x 10"	SS
38979	10" x 14"	PL

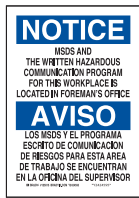

125015	10" x 7"	SS
125018	14" x 10"	SS
125014	10" x 7"	PL
125017	14" x 10"	PL
125013	10" x 7"	AL
125016	14" x 10"	AL



125075	10" x 7"	SS
125078	14" x 10"	SS
125074	10" x 7"	PL
125077	14" x 10"	PL
125073	10" x 7"	AL
125076	14" x 10"	AL



125081	10" x 7"	SS
125084	14" x 10"	SS
125080	10" x 7"	PL
125083	14" x 10"	PL
125079	10" x 7"	AL
125082	14" x 10"	AL



39718	7" x 10"	FB
39731	10" x 14"	FB
37690	7" x 10"	SS
38819	7" x 10"	PL
38837	10" x 14"	PL
38329	7" x 10"	AL
38338	10" x 14"	AL



# Bilingual and Spanish-Only Signs

BradyID.com/s34

## Bilingual and Spanish-Only Signs (Continued)



90811	14" x 10"	SS
38803	14" x 10"	PL
38313	14" x 10"	AL



125039	7" x 10"	SS
125042	10" x 14"	SS
125038	7" x 10"	PL
125041	10" x 14"	PL
125037	7" x 10"	AL
125040	10" x 14"	AL



38875	7" x 10"	PL
38902	10" x 14"	PL
38368	7" x 10"	AL



125051	10" x 7"	SS
125054	14" x 10"	SS
125050	10" x 7"	PL
125053	14" x 10"	PL
125049	10" x 7"	AL
125052	14" x 10"	AL



125003	7" x 10"	SS
125006	10" x 14"	SS
125002	7" x 10"	PL
125005	10" x 14"	PL
125001	7" x 10"	AL
125004	10" x 14"	AL



124985	10" x 7"	SS
124988	14" x 10"	SS
124984	10" x 7"	PL
124987	14" x 10"	PL
124983	10" x 7"	AL
124986	14" x 10"	AL



125045	10" x 7"	SS
125048	14" x 10"	SS
125044	10" x 7"	PL
125047	14" x 10"	PL
125043	10" x 7"	AL
125046	14" x 10"	AL



124973	10" x 7"	SS
124976	14" x 10"	SS
124972	10" x 7"	PL
124975	14" x 10"	PL
124971	10" x 7"	AL
124974	14" x 10"	AL



39740	20" x 14"	FB
90668	14" x 10"	SS
38848	14" x 10"	PL
38347	10" x 14"	AL



122810	7" x 10"	FB
122786	14" x 10"	FB
39514	20" x 14"	FB
122648	7" x 10"	SS
90544	14" x 10"	SS
122515	7" x 10"	PL
38614	14" x 10"	PL
122404	7" x 10"	AL
38114	14" x 10"	AL



39054	7" x 10"	PL
39055	10" x 14"	PL
38160	10" x 14"	AL



125057	10" x 7"	SS
125060	14" x 10"	SS
125056	10" x 7"	PL
125059	14" x 10"	PL
125055	10" x 7"	AL
125058	14" x 10"	AL



125027	10" x 7"	SS
125030	14" x 10"	SS
125026	10" x 7"	PL
125029	14" x 10"	PL
125025	10" x 7"	AL
125028	14" x 10"	AL



125021	10" x 7"	SS
125024	14" x 10"	SS
125020	10" x 7"	PL
125023	14" x 10"	PL
125019	10" x 7"	AL
125022	14" x 10"	AL



124967	7" x 10"	SS
124970	10" x 14"	SS
124966	7" x 10"	PL
124969	10" x 14"	PL
124965	7" x 10"	AL
124968	10" x 14"	AL



125489	7" x 10"	SS
125492	10" x 14"	SS
125488	7" x 10"	PL
125491	10" x 14"	PL
125487	7" x 10"	AL
125490	10" x 14"	AL



122914	7" x 10"	FB
122758	10" x 14"	FB
39512	20" x 14"	FB
90667	14" x 10"	SS
38612	14" x 10"	PL
38112	14" x 10"	AL



39537	7" x 10"	FB
37612	7" x 10"	SS
38637	7" x 10"	PL
38662	10" x 14"	PL
38134	7" x 10"	AL
38158	10" x 14"	AL



125087	10" x 7"	SS
125090	14" x 10"	SS
125086	10" x 7"	PL
125089	14" x 10"	PL
125085	10" x 7"	AL
125088	14" x 10"	AL



39613	20" x 14"	FB
90808	14" x 10"	SS
38188	14" x 10"	AL



39639	10" x 14"	FB
37645	7" x 10"	SS
38742	10" x 14"	PL
38239	10" x 14"	AL



# Bilingual and Spanish-Only Signs

BradyID.com/s34

## Bilingual and Spanish-Only Signs (Continued)



124165	7" x 10"	SS
124168	10" x 14"	SS
124164	7" x 10"	PL
124167	10" x 14"	PL
124163	7" x 10"	AL
124166	10" x 14"	AL

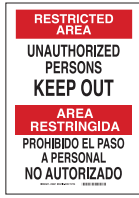

38616	14" x 10"	PL
-------	-----------	----



37616	7" x 10"	SS
38640	7" x 10"	PL
38665	10" x 14"	PL
38162	10" x 14"	AL



124003	10" x 7"	SS
124006	14" x 10"	SS
124002	10" x 7"	PL
124005	14" x 10"	PL
124001	10" x 7"	AL
124004	14" x 10"	AL

**Popular Sign Materials**

**FB** - Premium Fiberglass (B-120)  
**SS** - Self-Sticking Polyester (B-302)  
**BGSS** - BradyGlo™ Self-Sticking Polyester (B-324)  
**BGPL** - BradyGlo™ Plastic (B-347)  
**PL** - Plastic (B-401)  
**AL** - Aluminum (B-555)

*View all sign materials on page 25.*



124901	7" x 10"	SS
124904	10" x 14"	SS
124900	7" x 10"	PL
124903	10" x 14"	PL
124899	7" x 10"	AL
124902	10" x 14"	AL



39517	20" x 14"	FB
124895	10" x 7"	SS
124898	14" x 10"	SS
124894	10" x 7"	PL
38617	14" x 10"	PL
124893	10" x 7"	AL
38117	14" x 10"	AL



39542	7" x 10"	FB
39567	14" x 10"	FB
37617	7" x 10"	SS
38641	7" x 10"	PL
38666	10" x 14"	PL
38138	7" x 10"	AL
38163	10" x 14"	AL



39769	7" x 10"	FB
39789	10" x 14"	FB
37703	7" x 10"	SS
38877	7" x 10"	PL
38904	10" x 14"	PL
38370	7" x 10"	AL
38392	10" x 14"	AL



39742	20" x 14"	FB
90791	14" x 10"	SS
38850	14" x 10"	PL
38349	14" x 10"	AL



125501	7" x 10"	SS
125504	10" x 14"	SS
125500	7" x 10"	PL
125503	10" x 14"	PL
125499	7" x 10"	AL
125502	10" x 14"	AL



122808	7" x 10"	FB
122784	14" x 10"	FB
122646	7" x 10"	SS
122631	14" x 10"	SS
122513	7" x 10"	PL
38993	14" x 10"	PL
122402	7" x 10"	AL
38481	14" x 10"	AL



39029	10" x 14"	PL
-------	-----------	----



125543	7" x 10"	SS
125546	10" x 14"	SS
125542	7" x 10"	PL
125545	10" x 14"	PL
125541	7" x 10"	AL
125544	10" x 14"	AL



123991	7" x 10"	SS
123994	10" x 14"	SS
123990	7" x 10"	PL
123993	10" x 14"	PL
123989	7" x 10"	AL
123992	10" x 14"	AL



124135	10" x 7"	SS
124138	14" x 10"	SS
124134	10" x 7"	PL
124137	14" x 10"	PL
124133	10" x 7"	AL
124136	14" x 10"	AL



124027	10" x 7"	SS
124030	14" x 10"	SS
124026	10" x 7"	PL
124029	14" x 10"	PL
124025	10" x 7"	AL
124028	14" x 10"	AL



124564	18" x 4"	SS
124563	18" x 4"	PL
124562	18" x 4"	AL



38756	14" x 10"	PL
38253	14" x 10"	AL



37661	14" x 5"	SS
-------	----------	----



39649	14" x 20"	FB
90821	14" x 20"	SS



37657	12" x 9"	SS
38775	14" x 10"	PL
38272	14" x 10"	AL

# Bilingual and Spanish-Only Signs

BradyID.com/s34

## Bilingual and Spanish-Only Signs (Continued)

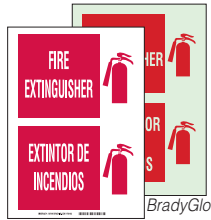

39880	20" x 14"	FB
90804	14" x 10"	SS
90156	10" x 7"	BGSS
90518	14" x 10"	BGSS
90687	10" x 7"	BGPL
90749	14" x 10"	BGPL
38994	14" x 10"	PL
38482	14" x 10"	AL



39012	7" x 10"	PL
-------	----------	----

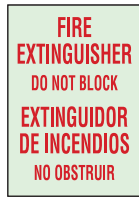

90158	10" x 7"	BGSS
90520	14" x 10"	BGSS
90751	14" x 10"	BGPL



124159	10" x 7"	SS
124162	14" x 10"	SS
124158	10" x 7"	PL
124161	14" x 10"	PL
124157	10" x 7"	AL
124160	14" x 10"	AL



125531	10" x 7"	SS
125534	14" x 10"	SS
125530	10" x 7"	PL
125533	14" x 10"	PL
125529	10" x 7"	AL
125532	14" x 10"	AL



124153	10" x 7"	SS
124156	14" x 10"	SS
124152	10" x 7"	PL
124155	14" x 10"	PL
124151	10" x 7"	AL
124154	14" x 10"	AL



125537	10" x 7"	SS
125540	14" x 10"	SS
125536	10" x 7"	PL
125539	14" x 10"	PL
125535	10" x 7"	AL
125538	14" x 10"	AL



39881	14" x 20"	FB
38995	14" x 10"	PL
38483	14" x 10"	AL



47655	10" x 7"	SS
47657	10" x 7"	PL
47658	10" x 7"	AL



47643	10" x 7"	SS
47645	10" x 7"	PL
47646	10" x 7"	AL



37660	14" x 5"	SS
-------	----------	----



125513	10" x 7"	SS
125516	14" x 10"	SS
125512	10" x 7"	PL
125515	14" x 10"	PL
125511	10" x 7"	AL
125514	14" x 10"	AL



39883	14" x 20"	FB
38997	14" x 10"	PL
38485	14" x 10"	AL



124021	10" x 7"	SS
124024	14" x 10"	SS
124020	10" x 7"	PL
124023	14" x 10"	PL
124019	10" x 7"	AL
124022	14" x 10"	AL



90670	14" x 10"	SS
90160	10" x 7"	BGSS
90522	14" x 10"	BGSS
90691	10" x 7"	BGPL
90753	14" x 10"	BGPL
38800	14" x 10"	PL
38310	14" x 10"	AL



37686	7" x 10"	SS
38816	7" x 10"	PL



124171	10" x 7"	SS
124174	14" x 10"	SS
124170	10" x 7"	PL
124173	14" x 10"	PL
124169	10" x 7"	AL
124172	14" x 10"	AL



39820	14" x 20"	FB
38931	14" x 10"	PL
38420	10" x 14"	AL



37740	7" x 10"	SS
38976	10" x 14"	PL



122802	7" x 10"	FB
122712	10" x 14"	FB
39821	14" x 20"	FB
122640	7" x 10"	SS
122572	10" x 14"	SS
90822	14" x 10"	SS
122507	7" x 10"	PL
38933	10" x 14"	PL
122396	7" x 10"	AL
122347	10" x 14"	AL



37743	10" x 7"	SS
38955	14" x 10"	PL
38444	14" x 10"	AL



39698	20" x 14"	FB
90662	14" x 10"	SS
90159	10" x 7"	BGSS
90521	14" x 10"	BGSS
90690	10" x 7"	BGPL
90752	14" x 10"	BGPL
38799	14" x 10"	PL
38309	14" x 10"	AL



124129	10" x 7"	SS
124132	14" x 10"	SS
124128	10" x 7"	PL
124131	14" x 10"	PL
124127	10" x 7"	AL
124130	14" x 10"	AL



125549	7" x 10"	SS
125552	10" x 14"	SS
125548	7" x 10"	PL
125551	10" x 14"	PL
125547	7" x 10"	AL
125550	10" x 14"	AL



# Bilingual and Spanish-Only Signs

BradyID.com/s34

## Bilingual and Spanish-Only Signs (Continued)



90555	10" x 7"	BGSS
90188	14" x 10"	BGSS
90633	10" x 7"	BGPL
90949	14" x 10"	BGPL



124572	18" x 18"	PL
124574	24" x 24"	PL
124571	18" x 18"	AL
124573	24" x 24"	AL



125093	10" x 7"	SS
125096	14" x 10"	SS
125092	10" x 7"	PL
125095	14" x 10"	PL
125091	10" x 7"	AL
125094	14" x 10"	AL



124111	10" x 7"	SS
124114	14" x 10"	SS
124110	10" x 7"	PL
124113	14" x 10"	PL
124109	10" x 7"	AL
124112	14" x 10"	AL

### Popular Sign Materials

**FB** - Premium Fiberglass (B-120)  
**SS** - Self-Sticking Polyester (B-302)  
**BGSS** - BradyGlo™ Self-Sticking Polyester (B-324)  
**BGPL** - BradyGlo™ Plastic (B-347)  
**PL** - Plastic (B-401)  
**AL** - Aluminum (B-555)

*View all sign materials on page 25.*



124644	12" x 18"	PL
124646	18" x 24"	PL
124643	12" x 18"	AL
124645	18" x 24"	AL



124907	10" x 7"	SS
124910	14" x 10"	SS
124906	10" x 7"	PL
124909	14" x 10"	PL
124905	10" x 7"	AL
124908	14" x 10"	AL



124177	7" x 10"	SS
124180	10" x 14"	SS
124176	7" x 10"	PL
124179	10" x 14"	PL
124175	7" x 10"	AL
124178	10" x 14"	AL



125525	10" x 7"	SS
125528	14" x 10"	SS
125524	10" x 7"	PL
125527	14" x 10"	PL
125523	10" x 7"	AL
125526	14" x 10"	AL



125519	10" x 7"	SS
125522	14" x 10"	SS
125518	10" x 7"	PL
125521	14" x 10"	PL
125517	10" x 7"	AL
125520	14" x 10"	AL



90685	10" x 7"	BGPL
-------	----------	------



39696	20" x 14"	FB
90805	14" x 10"	SS
90155	10" x 7"	BGSS
90157	14" x 10"	BGSS
90686	10" x 7"	BGPL
90748	14" x 10"	BGPL
38797	14" x 10"	PL
38307	14" x 10"	AL



37683	7" x 10"	SS
38813	7" x 10"	PL
38831	10" x 14"	PL
38323	7" x 10"	AL



90750	14" x 10"	BGPL
-------	-----------	------



125507	7" x 10"	SS
125510	10" x 14"	SS
125506	7" x 10"	PL
125509	10" x 14"	PL
125505	7" x 10"	AL
125508	10" x 14"	AL



### Create Your Own Custom Spanish Sign

With Brady's 'same as stock' pricing, you can translate any sign legend into a Spanish-Only sign quickly and easily for the same low price.

For more information contact Brady Customer Service at 1-888-272-3946.



## Biohazard Signs

Brady biohazard signs are used to identify equipment, rooms and materials which contain, or are contaminated with, hazardous agents. Biohazard marking is required by safety code 1910.1030(g)(1), which states that warning labels must be affixed to containers of regulated waste, refrigerators and freezers containing blood or other potentially infectious material.

**! OSHA Regulations**

**OSHA 29 CFR 1910.1030 Bloodborne Pathogens:**  
Labels required for containers and shipments. Employers to post biohazard signs at the entrance to work areas.

**DOT 49 CFR 172.400(b) Labeling Requirements:**  
Labeling is required for infectious substances which meets one or more hazard classifications.

**UN2814 Infectious Substances:** Ebola virus defined as Category A infectious substance.



126692	7" x 10"	SS
126695	10" x 14"	SS
126691	7" x 10"	PL
126694	10" x 14"	PL
126690	7" x 10"	AL
126693	10" x 14"	AL



126686	7" x 10"	SS
126689	10" x 14"	SS
126685	7" x 10"	PL
126688	10" x 14"	PL
126684	7" x 10"	AL
126687	10" x 14"	AL



126680	7" x 10"	SS
126683	10" x 14"	SS
126679	7" x 10"	PL
126682	10" x 14"	PL
126678	7" x 10"	AL
126681	10" x 14"	AL



126668	7" x 10"	SS
126671	10" x 14"	SS
126667	7" x 10"	PL
126670	10" x 14"	PL
126666	7" x 10"	AL
126669	10" x 14"	AL



126674	7" x 10"	SS
126677	10" x 14"	SS
126673	7" x 10"	PL
126676	10" x 14"	PL
126672	7" x 10"	AL
126675	10" x 14"	AL



62550	7" x 10"	FB
62812	10" x 14"	FB
21800	7" x 10"	PL
26575	10" x 14"	PL
83928	3-1/2" x 5"	SS
83753	7" x 10"	SS
46753	10" x 14"	AL



90704	10" x 7"	BGPL
-------	----------	------



69768	10" x 14"	FB
25742	7" x 10"	PL
25743	10" x 14"	PL
89170	3-1/2" x 5"	SS
85553	7" x 10"	SS
85554	10" x 14"	SS
43319	7" x 10"	AL
43320	10" x 14"	AL



126649	7" x 10"	PL
126652	10" x 14"	PL
126650	7" x 10"	SS
126653	10" x 14"	SS
126648	7" x 10"	AL
126651	10" x 14"	AL



69767	10" x 14"	FB
22211	7" x 10"	PL
22212	10" x 14"	PL
84216	7" x 10"	SS
84217	10" x 14"	SS
40775	7" x 10"	AL
40776	10" x 14"	AL



126625	10" x 7"	PL
126628	14" x 10"	PL
126626	10" x 7"	SS
126629	14" x 10"	SS
126624	10" x 7"	AL
126627	14" x 10"	AL



126643	10" x 7"	PL
126646	14" x 10"	PL
126644	10" x 7"	SS
126647	14" x 10"	SS
126642	10" x 7"	AL
126645	14" x 10"	AL



126637	10" x 7"	PL
126640	14" x 10"	PL
126638	10" x 7"	SS
126641	14" x 10"	SS
126636	10" x 7"	AL
126639	14" x 10"	AL



126631	10" x 7"	PL
126634	14" x 10"	PL
126632	10" x 7"	SS
126635	14" x 10"	SS
126630	10" x 7"	AL
126633	14" x 10"	AL



126655	10" x 7"	PL
126658	14" x 10"	PL
126656	10" x 7"	SS
126659	14" x 10"	SS
126654	10" x 7"	AL
126657	14" x 10"	AL



69815	14" x 10"	FB
25780	10" x 7"	PL
25781	14" x 10"	PL
89169	5" x 3-1/2"	SS
89163	10" x 7"	SS
89164	14" x 10"	SS
43357	10" x 7"	AL
43358	14" x 10"	AL



69789	7" x 17"	FB
-------	----------	----



126661	7" x 10"	PL
126664	10" x 14"	PL
126662	7" x 10"	SS
126665	10" x 14"	SS
126660	7" x 10"	AL
126663	10" x 14"	AL



69813	14" x 10"	FB
89158	10" x 7"	SS
89159	14" x 10"	SS

**View page 273 for biohazard labels, tape and waste disposal bags.**

# Blank Signs

BradyID.com/s34

## Blank Signs

Brady offers a variety of blank signs and panels that can be customized to your specific needs using a Brady sign printer. Simply print your custom legend onto the blank sign and remove the liner to create your custom sign. Blank signs with pre-printed headers are also available in a range of sizes and materials.

### Popular Sign Materials

- FB** - Premium Fiberglass (B-120)
- SS** - Self-Sticking Polyester (B-302)
- BGSS** - BradyGlo™ Self-Sticking Polyester (B-324)
- BGPL** - BradyGlo™ Plastic (B-347)
- PL** - Plastic (B-401)
- AL** - Aluminum (B-555)
- TG** - Polycoated Tagstock (B-101)
- TMP** - Temporary Fluted Polypropylene (B-836)

View all sign materials on page 25.

Safety Signs



65263	7" x 10"	TG
65264	10" x 14"	TG
76005	7" x 10"	FB
47002	10" x 14"	FB
76006	14" x 20"	FB
88918	7" x 10"	SS
88919	10" x 14"	SS
25356	7" x 10"	PL
25357	10" x 14"	PL
42933	7" x 10"	AL
42934	10" x 14"	AL
78063	10" x 14"	TMP
78064	14" x 20"	TMP



65261	7" x 10"	TG
65262	10" x 14"	TG
76009	7" x 10"	FB
47004	10" x 14"	FB
76013	14" x 20"	FB
88925	7" x 10"	SS
88926	10" x 14"	SS
25360	7" x 10"	PL
25361	10" x 14"	PL
42937	7" x 10"	AL
42938	10" x 14"	AL
78066	10" x 14"	TMP
78067	14" x 20"	TMP
77995	18" x 24"	TMP



65266	10" x 14"	TG
76015	7" x 10"	FB
47014	10" x 14"	FB
76021	14" x 20"	FB
88932	7" x 10"	SS
88933	10" x 14"	SS
25364	7" x 10"	PL
25365	10" x 14"	PL
42941	7" x 10"	AL
42942	10" x 14"	AL
77997	18" x 24"	TMP



69806	10" x 14"	FB
88944	7" x 10"	SS
88945	10" x 14"	SS
25372	7" x 10"	PL
25373	10" x 14"	PL
42949	7" x 10"	AL
42950	10" x 14"	AL



75990	10" x 14"	FB
88942	7" x 10"	SS
25370	7" x 10"	PL
25371	10" x 14"	PL
42948	10" x 14"	AL
78073	14" x 20"	TMP

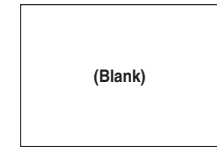

76063	7" x 10"	FB
47000	10" x 14"	FB
76034	14" x 20"	FB
76036	20" x 28"	FB
88948	7" x 10"	SS
88949	10" x 14"	SS
25963	3-1/2" x 5"	PL
25960	5" x 7"	PL
25376	7" x 10"	PL
25377	10" x 14"	PL
42953	7" x 10"	AL
42954	10" x 14"	AL
78084	7" x 10"	TMP
78086	14" x 20"	TMP
77998	18" x 24"	TMP

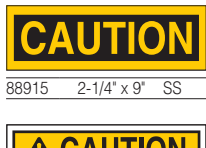

88915	2-1/4" x 9"	SS
-------	-------------	----



88922	2-1/4" x 9"	SS
88924	5" x 14"	SS

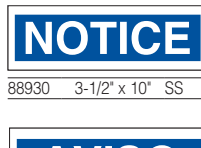

88930	3-1/2" x 10"	SS
-------	--------------	----



88064	2-1/4" x 9"	SS
88065	3-1/2" x 10"	SS
88066	5" x 14"	SS



88941	2-1/4" x 9"	SS
-------	-------------	----

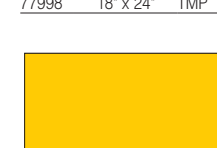

76064	7" x 10"	FB
76040	10" x 14"	FB
76045	14" x 20"	FB
76050	20" x 28"	FB
88946	7" x 10"	SS
88947	10" x 14"	SS
25964	3-1/2" x 5"	PL
25961	5" x 7"	PL
25374	7" x 10"	PL
25375	10" x 14"	PL
42951	7" x 10"	AL
42952	10" x 14"	AL
78083	14" x 20"	TMP
77999	18" x 24"	TMP



76097	7" x 10"	FB
76098	10" x 14"	FB
88052	7" x 10"	SS
88053	10" x 14"	SS
25971	7" x 10"	PL
25972	10" x 14"	PL



76100	7" x 10"	FB
76101	10" x 14"	FB
88054	7" x 10"	SS
25973	7" x 10"	PL
42252	7" x 10"	AL

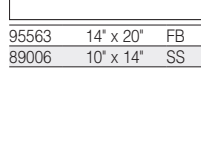

95563	14" x 20"	FB
89006	10" x 14"	SS



69825	10" x 14"	FB
88056	7" x 10"	SS
88057	10" x 14"	SS
25975	7" x 10"	PL
42254	7" x 10"	AL
42255	10" x 14"	AL



76061	10" x 14"	FB
88914	10" x 14"	SS



95559	10" x 14"	FB
89001	7" x 10"	SS
25406	7" x 10"	PL
25407	10" x 14"	PL



42986	10" x 14"	AL
-------	-----------	----



65825	10" x 14"	FB
65828	10" x 14"	AL



76053	10" x 14"	FB
76056	14" x 20"	FB
88939	7" x 10"	SS
25368	7" x 10"	PL
25369	10" x 14"	PL



69809	10" x 14"	FB
69810	14" x 20"	FB
89113	7" x 10"	SS
25962	5" x 7"	PL
25886	10" x 14"	PL
43462	7" x 10"	AL



88935	10" x 14"	SS
25366	7" x 10"	PL



74871	10" x 14"	FB
88927	7" x 10"	SS
88928	10" x 14"	SS
25362	7" x 10"	PL



25413	10" x 14"	PL
-------	-----------	----

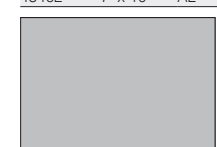

65159	18" x 18"	B-959
-------	-----------	-------

## Braille (ADA) Signs









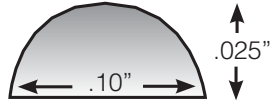

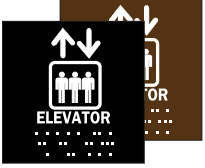
Brady Braille signs meet ADA requirements and ICC / ANSI 117.1 specifications for identifying permanent rooms within a building. Braille signs are required by law under the Americans with Disabilities Act. These Braille signs are available in more than 15 stock legends to identify restrooms, elevators, exits, safety equipment and more.

Brady Braille signs are made of Non Glare Rigid Plastic (B-81) material. Double-sided tape included.

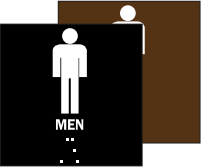
**?** **Did You Know?**



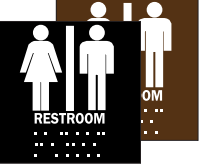
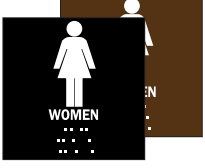
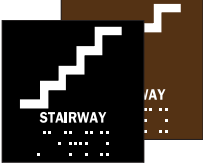



All Braille signs feature a true dome-shaped Braille dot to meet ICC / ANSI 117.1 specifications.



 70123 6" x 6" B-81 Black	 70109 8" x 8" B-81 Black 70135 8" x 8" B-81 Brown	 70167 2" x 8" B-81 Brown	 70161 8" x 8" B-81 Black 73447 8" x 8" B-81 Brown	 70115 2" x 8" B-81 Black 70141 2" x 8" B-81 Brown	 70105 8" x 8" B-81 Black																									
 70102 8" x 8" B-81 Black 70128 8" x 8" B-81 Brown	 70112 2" x 8" B-81 Black 70138 2" x 8" B-81 Brown	 73445 8" x 8" B-81 Brown	 70117 2" x 8" B-81 Black	 70103 8" x 8" B-81 Black 70129 8" x 8" B-81 Brown	 73400 8" x 8" B-81 Black 70127 8" x 8" B-81 Brown																									
 70110 8" x 8" B-81 Black 70136 8" x 8" B-81 Brown	 70137 2" x 8" B-81 Brown	<h3>Braille (ADA) Sign Frames</h3> <ul style="list-style-type: none"> <li>• Square cornered frames available to fit all Braille (ADA) signs above</li> </ul> <table border="1"> <thead> <tr> <th>Catalog #</th> <th>Description</th> <th>Size</th> <th>Material</th> <th>Color</th> </tr> </thead> <tbody> <tr> <td>70153</td> <td>Braille Sign Frame</td> <td>2" x 8"</td> <td>High Impact Styrene</td> <td>Black</td> </tr> <tr> <td>73446</td> <td>Braille Sign Frame</td> <td>2" x 8"</td> <td>High Impact Styrene</td> <td>Brown</td> </tr> <tr> <td>73403</td> <td>Braille Sign Frame</td> <td>8" x 8"</td> <td>High Impact Styrene</td> <td>Black</td> </tr> <tr> <td>70152</td> <td>Braille Sign Frame</td> <td>8" x 8"</td> <td>High Impact Styrene</td> <td>Brown</td> </tr> </tbody> </table>				Catalog #	Description	Size	Material	Color	70153	Braille Sign Frame	2" x 8"	High Impact Styrene	Black	73446	Braille Sign Frame	2" x 8"	High Impact Styrene	Brown	73403	Braille Sign Frame	8" x 8"	High Impact Styrene	Black	70152	Braille Sign Frame	8" x 8"	High Impact Styrene	Brown
Catalog #	Description	Size	Material	Color																										
70153	Braille Sign Frame	2" x 8"	High Impact Styrene	Black																										
73446	Braille Sign Frame	2" x 8"	High Impact Styrene	Brown																										
73403	Braille Sign Frame	8" x 8"	High Impact Styrene	Black																										
70152	Braille Sign Frame	8" x 8"	High Impact Styrene	Brown																										

## California (ADA) Restroom Signs

- California ADA standards specify circular or triangular signs be mounted onto restroom doors
- Double-sided foam tape included

 106179 10" x 11" Plastic Blue	 106182 10" x 11" Plastic Blue	 106181 12 dia. Plastic Blue
 106180 12 dia. Plastic Blue 106186 12 dia. Plastic Black	 106183 13 dia. Plastic Black	 106184 12 dia. Plastic Blue



# Chemical & Hazardous Material Signs

BradyID.com/s34

## Chemical & Hazardous Material Signs

Brady's chemical signs are used to identify your plant's chemical storage and hazardous materials areas. These signs keep your employees safe by clearly indicating where and how chemicals are kept. Brady offers more than 175 stock legends to help you comply with OSHA standards. Chemical signs and hazardous material signs are available in a variety of sizes and materials.

Safety Signs



125888	7" x 10"	SS
125891	10" x 14"	SS
125887	7" x 10"	PL
125890	10" x 14"	PL
125886	7" x 10"	AL
125889	10" x 14"	AL



69371	10" x 14"	FB
84285	7" x 10"	SS
84286	10" x 14"	SS
22262	7" x 10"	PL
22263	10" x 14"	PL
40826	7" x 10"	AL
40827	10" x 14"	AL



125894	7" x 10"	SS
125897	10" x 14"	SS
125893	7" x 10"	PL
125896	10" x 14"	PL
125892	7" x 10"	AL
125895	10" x 14"	AL



76080	10" x 14"	FB
85382	7" x 10"	SS
85383	10" x 14"	SS
22697	7" x 10"	PL
22698	10" x 14"	PL
41261	7" x 10"	AL
41262	10" x 14"	AL



69290	14" x 20"	FB
85384	7" x 10"	SS
85385	10" x 14"	SS
22699	7" x 10"	PL
22700	10" x 14"	PL
41264	10" x 14"	AL



58763	10" x 14"	FB
58764	14" x 20"	FB
89087	7" x 10"	SS
89088	10" x 14"	SS
25418	7" x 10"	PL
25419	10" x 14"	PL
42995	7" x 10"	AL
42996	10" x 14"	AL



69291	14" x 20"	FB
85386	7" x 10"	SS
22701	7" x 10"	PL
41266	10" x 14"	AL



125900	7" x 10"	SS
125903	10" x 14"	SS
125899	7" x 10"	PL
125902	10" x 14"	PL
125898	7" x 10"	AL
125901	10" x 14"	AL



125906	7" x 10"	SS
125909	10" x 14"	SS
125905	7" x 10"	PL
125908	10" x 14"	PL
125904	7" x 10"	AL
125907	10" x 14"	AL



69775	10" x 14"	FB
22703	7" x 10"	PL
22704	10" x 14"	PL
41267	7" x 10"	AL
41268	10" x 14"	AL



125918	7" x 10"	SS
125921	10" x 14"	SS
125917	7" x 10"	PL
125920	10" x 14"	PL
125916	7" x 10"	AL
125919	10" x 14"	AL



43496	10" x 14"	AL
-------	-----------	----



125924	7" x 10"	SS
125927	10" x 14"	SS
125923	7" x 10"	PL
125926	10" x 14"	PL
125922	7" x 10"	AL
125925	10" x 14"	AL



125930	10" x 7"	SS
125933	14" x 10"	SS
125929	10" x 7"	PL
125932	14" x 10"	PL
125928	10" x 7"	AL
125931	14" x 10"	AL



125936	7" x 10"	SS
125939	10" x 14"	SS
125935	7" x 10"	PL
125938	10" x 14"	PL
125934	7" x 10"	AL
125937	10" x 14"	AL



76073	10" x 14"	FB
84289	7" x 10"	SS
40829	10" x 14"	AL



69042	10" x 14"	FB
84291	7" x 10"	SS
84292	10" x 14"	SS
22266	7" x 10"	PL
22267	10" x 14"	PL
40831	10" x 14"	AL



43514	10" x 14"	AL
-------	-----------	----



84293	7" x 10"	SS
84294	10" x 14"	SS
22268	7" x 10"	PL
22269	10" x 14"	PL
40832	7" x 10"	AL
40833	10" x 14"	AL



125942	7" x 10"	SS
125945	10" x 14"	SS
125941	7" x 10"	PL
125944	10" x 14"	PL
125940	7" x 10"	AL
125943	10" x 14"	AL



125750	7" x 10"	SS
125753	10" x 14"	SS
125749	7" x 10"	PL
125752	10" x 14"	PL
125748	7" x 10"	AL
125751	10" x 14"	AL



70256	10" x 14"	FB
84295	7" x 10"	SS
84296	10" x 14"	SS
22270	7" x 10"	PL
40834	7" x 10"	AL



122838	7" x 10"	FB
47117	10" x 14"	FB
84297	7" x 10"	SS
84298	10" x 14"	SS
22272	7" x 10"	PL
22273	10" x 14"	PL
40836	7" x 10"	AL
40837	10" x 14"	AL



125954	7" x 10"	SS
125957	10" x 14"	SS
125953	7" x 10"	PL
125956	10" x 14"	PL
125952	7" x 10"	AL
125955	10" x 14"	AL

### Popular Sign Materials

- FB** - Premium Fiberglass (B-120)
  - SS** - Self-Sticking Polyester (B-302)
  - BGSS** - BradyGlo™ Self-Sticking Polyester (B-324)
  - BGPL** - BradyGlo™ Plastic (B-347)
  - PL** - Plastic (B-401)
  - AL** - Aluminum (B-555)
- View all sign materials on page 25.

### Can't find your sign?

Use the Sign Legend Index on page 498 or take advantage of our custom sign options.

### OSHA Regulations

#### Appendix A to 1910.1450

Prominent signs of the following types should be posted:

- (a) Emergency telephone numbers of emergency personnel/facilities, supervisors, and laboratory workers;
- (b) Location signs for safety showers, eyewash stations, other safety and first aid equipment, and exits; and
- (c) Warnings at areas or equipment where special or unusual hazards exist.



# Chemical & Hazardous Material Signs

BradyID.com/s34

## Chemical & Hazardous Material Signs (Continued)

<p><b>CAUTION</b> DO NOT POUR CHEMICALS DOWN THE DRAIN</p>	<p><b>CAUTION</b> EXTREMELY COLD LIQUID NITROGEN DO NOT TOUCH</p>	<p><b>CAUTION</b> EYE AND GLOVE PROTECTION MUST BE WORN WHEN HANDLING CHEMICALS</p>	<p><b>CAUTION</b> FLAMMABLE LIQUIDS</p>	<p><b>CAUTION</b> FUMES MAY BE PRESENT</p>	<p><b>CAUTION</b> H<sub>2</sub>S POISONOUS GAS MAY BE PRESENT</p>
125960 7' x 10' SS 125963 10' x 14' SS 125959 7' x 10' PL 125962 10' x 14' PL 125958 7' x 10' AL 125961 10' x 14' AL	125966 7' x 10' SS 125969 10' x 14' SS 125965 7' x 10' PL 125968 10' x 14' PL 125964 7' x 10' AL 125967 10' x 14' AL	69228 10' x 14' FB 84301 7' x 10' SS 84302 10' x 14' SS 22277 10' x 14' PL 40840 7' x 10' AL 40841 10' x 14' AL	125972 7' x 10' SS 125975 10' x 14' SS 125971 7' x 10' PL 125974 10' x 14' PL 125970 7' x 10' AL 125973 10' x 14' AL	125978 7' x 10' SS 125981 10' x 14' SS 125977 7' x 10' PL 125980 10' x 14' PL 125976 7' x 10' AL 125979 10' x 14' AL	124282 7' x 10' SS 124285 10' x 14' SS 124281 7' x 10' PL 124284 10' x 14' PL 124280 7' x 10' AL 124283 10' x 14' AL
<p><b>CAUTION</b> HAZARDOUS CHEMICALS AUTHORIZED PERSONNEL ONLY</p>	<p><b>CAUTION</b> HAZARDOUS MATERIALS HANDLE WITH CARE</p>	<p><b>CAUTION</b> HAZARDOUS MATERIALS MAY BE USED IN THIS AREA • SEE MSDS •</p>	<p><b>CAUTION</b> HAZARDOUS WASTE AREA LABELED DRUMS ONLY</p>	<p><b>CAUTION</b> HAZARDOUS WASTE MATERIAL STORAGE ONLY NO SMOKING, OPEN FLAMES OR OPEN LIGHTS</p>	<p><b>CAUTION</b> HAZARDOUS WASTE STORAGE AREA UNAUTHORIZED PERSONS KEEP OUT</p>
126008 7' x 10' SS 126011 10' x 14' SS 126007 7' x 10' PL 126010 10' x 14' PL 126006 7' x 10' AL 126009 10' x 14' AL	125990 7' x 10' SS 125993 10' x 14' SS 125989 7' x 10' PL 125992 10' x 14' PL 125988 7' x 10' AL 125991 10' x 14' AL	126002 7' x 10' SS 126005 10' x 14' SS 126001 7' x 10' PL 126004 10' x 14' PL 126000 7' x 10' AL 126003 10' x 14' AL	125996 7' x 10' SS 125999 10' x 14' SS 125995 7' x 10' PL 125998 10' x 14' PL 125994 7' x 10' AL 125997 10' x 14' AL	122898 7' x 10' FB 122760 10' x 14' FB 69005 14' x 20' FB 85407 7' x 10' SS 85408 10' x 14' SS 22707 7' x 10' PL 22708 10' x 14' PL 41271 7' x 10' AL 41272 10' x 14' AL	122842 7' x 10' FB 70374 10' x 14' FB 85409 7' x 10' SS 85410 10' x 14' SS 22709 7' x 10' PL 22710 10' x 14' PL 41273 7' x 10' AL 41274 10' x 14' AL
<p><b>CAUTION</b> HIGH PRESSURE PIPELINE</p>	<p><b>CAUTION</b> KEEP ALL CYLINDERS CHAINED</p>	<p><b>CAUTION</b> LEAD HAZARD AREA WEAR RESPIRATOR POSSESSION OR USE OF TOBACCO PRODUCTS IS PROHIBITED</p>	<p><b>CAUTION</b> LEAD HAZARD DO NOT ENTER WORK AREA UNLESS AUTHORIZED</p>	<p><b>CAUTION</b> LOW-PRESSURE MANIFOLD DO NOT CONNECT HIGH-PRESSURE CYLINDERS MAXIMUM PRESSURE - 250 PSIG (1.7MPa)</p>	<p><b>CAUTION</b> NO CHEMICALS IN DRAINS USE CHEMICAL WASTE CONTAINERS</p>
85411 7' x 10' SS 85412 10' x 14' SS 22711 7' x 10' PL 22712 10' x 14' PL 41275 7' x 10' AL 41276 10' x 14' AL	126014 7' x 10' SS 126017 10' x 14' SS 126013 7' x 10' PL 126016 10' x 14' PL 126012 7' x 10' AL 126015 10' x 14' AL	85414 10' x 14' SS 22713 7' x 10' PL 22714 10' x 14' PL	126020 7' x 10' SS 126023 10' x 14' SS 126019 7' x 10' PL 126022 10' x 14' PL 126018 7' x 10' AL 126021 10' x 14' AL	126026 7' x 10' SS 126029 10' x 14' SS 126025 7' x 10' PL 126028 10' x 14' PL 126024 7' x 10' AL 126027 10' x 14' AL	126032 7' x 10' SS 126035 10' x 14' SS 126031 7' x 10' PL 126034 10' x 14' PL 126030 7' x 10' AL 126033 10' x 14' AL
<p><b>CAUTION</b> NON-POTABLE WATER DO NOT DRINK</p>	<p><b>CAUTION</b> PERSONAL PROTECTIVE CLOTHING IS TO BE WORN AT ALL TIMES WHEN HANDLING CHEMICALS</p>	<p><b>CAUTION</b> PESTICIDES</p>	<p><b>CAUTION</b> POSSIBLE HYDROGEN SULFIDE GAS PRESENT</p>	<p><b>CAUTION</b> PREGNANT WOMEN SHOULD NOT ENTER</p>	<p><b>CAUTION</b> PREVENT STATIC SPARK DISCHARGE USE GROUNDING DEVICES</p>
69408 10' x 14' FB 84313 7' x 10' SS 84314 10' x 14' SS 22282 7' x 10' PL 22283 10' x 14' PL 40846 7' x 10' AL 40847 10' x 14' AL	84315 7' x 10' SS 84316 10' x 14' SS 22285 10' x 14' PL 40848 7' x 10' AL 40849 10' x 14' AL	126038 7' x 10' SS 126041 10' x 14' SS 126037 7' x 10' PL 126040 10' x 14' PL 126036 7' x 10' AL 126039 10' x 14' AL	72573 10' x 14' FB 84317 7' x 10' SS 84318 10' x 14' SS 22287 10' x 14' PL 40850 7' x 10' AL 40851 10' x 14' AL	126044 7' x 10' SS 126047 10' x 14' SS 126043 7' x 10' PL 126046 10' x 14' PL 126042 7' x 10' AL 126045 10' x 14' AL	84319 7' x 10' SS 84320 10' x 14' SS 22289 10' x 14' PL 40852 7' x 10' AL 40853 10' x 14' AL
<p><b>CAUTION</b> QUARANTINE AREA</p>	<p><b>CAUTION</b> SECURE ALL TANKS CHAIN CYLINDERS</p>	<p><b>CAUTION</b> THE PLACEMENT OF HAZARDOUS WASTE IN THIS CONTAINER IS STRICTLY PROHIBITED</p>	<p><b>CAUTION</b> TOXIC/HAZARDOUS CHEMICALS ARE USED IN THIS WORKPLACE SAFETY DATA SHEETS ARE AVAILABLE IN THE SUPERVISOR'S OFFICE</p>	<p><b>CAUTION</b> USED BATTERIES</p>	<p><b>CAUTION</b> VERY HOT WATER</p>
126050 7' x 10' SS 126053 10' x 14' SS 126049 7' x 10' PL 126052 10' x 14' PL 126048 7' x 10' AL 126051 10' x 14' AL	73422 10' x 14' FB 85417 7' x 10' SS 85418 10' x 14' SS 22717 7' x 10' PL 22718 10' x 14' PL 41281 7' x 10' AL 41282 10' x 14' AL	126056 7' x 10' SS 126059 10' x 14' SS 126055 7' x 10' PL 126058 10' x 14' PL 126054 7' x 10' AL 126057 10' x 14' AL	70559 10' x 14' FB 84321 7' x 10' SS 84322 10' x 14' SS 22291 10' x 14' PL	126062 7' x 10' SS 126065 10' x 14' SS 126061 7' x 10' PL 126064 10' x 14' PL 126060 7' x 10' AL 126063 10' x 14' AL	126068 7' x 10' SS 126071 10' x 14' SS 126067 7' x 10' PL 126070 10' x 14' PL 126066 7' x 10' AL 126069 10' x 14' AL



# Chemical & Hazardous Material Signs

BradyID.com/s34

## Chemical & Hazardous Material Signs (Continued)



126074	10" x 7"	SS
126077	14" x 10"	SS
126073	10" x 7"	PL
126076	14" x 10"	PL
126072	10" x 7"	AL
126075	14" x 10"	AL



126086	7" x 10"	SS
126089	10" x 14"	SS
126085	7" x 10"	PL
126088	10" x 14"	PL
126084	7" x 10"	AL
126087	10" x 14"	AL



126092	7" x 10"	SS
126095	10" x 14"	SS
126091	7" x 10"	PL
126094	10" x 14"	PL
126090	7" x 10"	AL
126093	10" x 14"	AL



43499	10" x 14"	AL
-------	-----------	----

**Popular Sign Materials**

- FB - Premium Fiberglass (B-120)
- SS - Self-Sticking Polyester (B-302)
- BGSS - BradyGlo™ Self-Sticking Polyester (B-324)
- BGPL - BradyGlo™ Plastic (B-347)
- PL - Plastic (B-401)
- AL - Aluminum (B-555)

View all sign materials on page 25.

**Can't find your sign?**  
Use the Sign Legend Index on page 498 or take advantage of our custom sign options.



126080	7" x 10"	SS
126083	10" x 14"	SS
126079	7" x 10"	PL
126082	10" x 14"	PL
126078	7" x 10"	AL
126081	10" x 14"	AL



70206	7" x 10"	FB
70207	10" x 14"	FB
84323	7" x 10"	SS
84324	10" x 14"	SS
22292	7" x 10"	PL
22293	10" x 14"	PL
40856	7" x 10"	AL
40857	10" x 14"	AL



122819	7" x 10"	FB
47206	10" x 14"	FB
84326	7" x 10"	SS
84327	10" x 14"	SS
122518	7" x 10"	PL
22295	10" x 14"	PL
40858	7" x 10"	AL
40859	10" x 14"	AL



70208	7" x 17"	FB
-------	----------	----



131825	7" x 10"	FB
131826	10" x 14"	FB
131823	7" x 10"	SS
131824	10" x 14"	SS
131821	7" x 10"	PL
131822	10" x 14"	PL
131819	7" x 10"	AL
131820	10" x 14"	AL



126110	7" x 10"	SS
126113	10" x 14"	SS
126109	7" x 10"	PL
126112	10" x 14"	PL
126108	7" x 10"	AL
126111	10" x 14"	AL



126116	7" x 10"	SS
126119	10" x 14"	SS
126115	7" x 10"	PL
126118	10" x 14"	PL
126114	7" x 10"	AL
126117	10" x 14"	AL



84332	7" x 10"	SS
84333	10" x 14"	SS
22296	7" x 10"	PL
22297	10" x 14"	PL
40860	7" x 10"	AL
40861	10" x 14"	AL



126104	7" x 10"	SS
126107	10" x 14"	SS
126103	7" x 10"	PL
126106	10" x 14"	PL
126102	7" x 10"	AL
126105	10" x 14"	AL



84334	7" x 10"	SS
84335	10" x 14"	SS
22298	7" x 10"	PL
25878	10" x 14"	PL
40862	7" x 10"	AL
43455	10" x 14"	AL



126122	7" x 10"	SS
126125	10" x 14"	SS
126121	7" x 10"	PL
126124	10" x 14"	PL
126120	7" x 10"	AL
126123	10" x 14"	AL



125822	7" x 10"	SS
125825	10" x 14"	SS
125821	7" x 10"	PL
125824	10" x 14"	PL
125820	7" x 10"	AL
125823	10" x 14"	AL



131861	7" x 10"	FB
131862	10" x 14"	FB
131859	7" x 10"	SS
84337	10" x 14"	SS
22299	7" x 10"	PL
22300	10" x 14"	PL
40863	7" x 10"	AL
40864	10" x 14"	AL



84338	7" x 10"	SS
84339	10" x 14"	SS
22301	7" x 10"	PL
22302	10" x 14"	PL
40865	7" x 10"	AL
40866	10" x 14"	AL



126194	7" x 10"	SS
126197	10" x 14"	SS
126193	7" x 10"	PL
126196	10" x 14"	PL
126192	7" x 10"	AL
126195	10" x 14"	AL



70217	10" x 14"	FB
84340	7" x 10"	SS
84341	10" x 14"	SS
22304	10" x 14"	PL
40867	7" x 10"	AL
40868	10" x 14"	AL

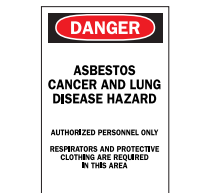

74520	20" x 14"	FB
85437	10" x 7"	SS
85438	14" x 10"	SS
22721	10" x 7"	PL
22722	14" x 10"	PL
41285	10" x 7"	AL
41286	14" x 10"	AL



123661	7" x 10"	SS
123664	10" x 14"	SS
123660	7" x 10"	PL
123663	10" x 14"	PL
123659	7" x 10"	AL
123662	10" x 14"	AL



125810	7" x 10"	SS
125813	10" x 14"	SS
125809	7" x 10"	PL
125812	10" x 14"	PL
125808	7" x 10"	AL
125811	10" x 14"	AL



75974	7" x 10"	FB
75975	10" x 14"	FB
85439	7" x 10"	SS
22723	7" x 10"	PL



85441	7" x 10"	SS
85442	10" x 14"	SS
69765	10" x 14"	FB
22725	7" x 10"	PL
22726	10" x 14"	PL



85443	7" x 10"	SS
85444	10" x 14"	SS
25777	10" x 14"	PL
43353	7" x 10"	AL
43354	10" x 14"	AL



126128	7" x 10"	SS
126131	10" x 14"	SS
126127	7" x 10"	PL
126130	10" x 14"	PL
126126	7" x 10"	AL
126129	10" x 14"	AL



125834	7" x 10"	SS
125837	10" x 14"	SS
125833	7" x 10"	PL
125836	10" x 14"	PL
125832	7" x 10"	AL
125835	10" x 14"	AL

Safety Signs

# Chemical & Hazardous Material Signs

BradyID.com/s34

## Chemical & Hazardous Material Signs (Continued)



23090 7' x 10' PL  
41990 7' x 10' AL  
41991 10' x 14' AL



126140 7' x 10' SS  
126143 10' x 14' SS  
126139 7' x 10' PL  
126142 10' x 14' PL  
126138 7' x 10' AL  
126141 10' x 14' AL



126134 7' x 10' SS  
126137 10' x 14' SS  
126133 7' x 10' PL  
126136 10' x 14' PL  
126132 7' x 10' AL  
126135 10' x 14' AL



72392 7' x 10' FB  
73489 10' x 14' FB  
84345 7' x 10' SS  
84346 10' x 14' SS  
22305 7' x 10' PL  
22306 10' x 14' PL  
40869 7' x 10' AL  
40870 10' x 14' AL



126146 7' x 10' SS  
126149 10' x 14' SS  
126145 7' x 10' PL  
126148 10' x 14' PL  
126144 7' x 10' AL  
126147 10' x 14' AL



22308 10' x 14' PL  
40871 7' x 10' AL



126152 7' x 10' SS  
126155 10' x 14' SS  
126151 7' x 10' PL  
126154 10' x 14' PL  
126150 7' x 10' AL  
126153 10' x 14' AL



84349 7' x 10' SS  
84350 10' x 14' SS  
22309 7' x 10' PL  
22310 10' x 14' PL  
40873 7' x 10' AL  
40874 10' x 14' AL



122820 7' x 10' FB  
70240 10' x 14' FB  
84351 7' x 10' SS  
84352 10' x 14' SS  
22311 7' x 10' PL  
22312 10' x 14' PL  
122406 7' x 10' AL  
40876 10' x 14' AL



131753 7' x 10' FB  
131754 10' x 14' FB  
131751 7' x 10' SS  
131752 10' x 14' SS  
131749 7' x 10' PL  
131750 10' x 14' PL  
131747 7' x 10' AL  
131748 10' x 14' AL



131829 7' x 10' FB  
72408 10' x 14' FB  
84355 7' x 10' SS  
84356 10' x 14' SS  
22313 7' x 10' PL  
22314 10' x 14' PL  
40877 7' x 10' AL  
40878 10' x 14' AL



69043 10' x 14' FB  
84357 7' x 10' SS  
84358 10' x 14' SS  
22315 7' x 10' PL  
22316 10' x 14' PL  
40879 7' x 10' AL  
40880 10' x 14' AL



125840 7' x 10' SS  
125843 10' x 14' SS  
125839 7' x 10' PL  
125842 10' x 14' PL  
125838 7' x 10' AL  
125841 10' x 14' AL



126158 7' x 10' SS  
126161 10' x 14' SS  
126157 7' x 10' PL  
126160 10' x 14' PL  
126156 7' x 10' AL  
126159 10' x 14' AL



122821 7' x 10' FB  
70246 10' x 14' FB  
84361 7' x 10' SS  
84362 10' x 14' SS  
22317 7' x 10' PL  
22318 10' x 14' PL  
40881 7' x 10' AL  
40882 10' x 14' AL



131809 7' x 10' FB  
131810 10' x 14' FB  
131807 7' x 10' SS  
131808 10' x 14' SS  
131805 7' x 10' PL  
131806 10' x 14' PL  
131803 7' x 10' AL  
131804 10' x 14' AL



126164 7' x 10' SS  
126167 10' x 14' SS  
126163 7' x 10' PL  
126166 10' x 14' PL  
126162 7' x 10' AL  
126165 10' x 14' AL



126164 7' x 10' SS  
126167 10' x 14' SS  
126163 7' x 10' PL  
126166 10' x 14' PL  
126162 7' x 10' AL  
126165 10' x 14' AL



125876 7' x 10' SS  
125879 10' x 14' SS  
125875 7' x 10' PL  
125878 10' x 14' PL  
125874 7' x 10' AL  
125877 10' x 14' AL



69054 10' x 14' FB  
84366 10' x 14' SS  
22321 7' x 10' PL  
22322 10' x 14' PL  
40885 7' x 10' AL  
40886 10' x 14' AL



122909 7' x 10' FB  
122770 10' x 14' FB  
85451 3-1/2' x 5' SS  
85452 7' x 10' SS  
85453 10' x 14' SS  
122562 7' x 10' PL  
122499 10' x 14' PL  
122458 7' x 10' AL  
122387 10' x 14' AL



125948 7' x 10' SS  
125951 10' x 14' SS  
125947 7' x 10' PL  
125950 10' x 14' PL  
125946 7' x 10' AL  
125949 10' x 14' AL



126170 7' x 10' SS  
126173 10' x 14' SS  
126169 7' x 10' PL  
126172 10' x 14' PL  
126168 7' x 10' AL  
126171 10' x 14' AL



126176 7' x 10' SS  
126179 10' x 14' SS  
126175 7' x 10' PL  
126178 10' x 14' PL  
126174 7' x 10' AL  
126177 10' x 14' AL



122822 7' x 10' FB  
70258 10' x 14' FB  
122650 7' x 10' SS  
84368 10' x 14' SS  
22323 7' x 10' PL  
22324 10' x 14' PL  
40887 7' x 10' AL  
40888 10' x 14' AL



69070 7' x 17' FB



84369 7' x 10' SS  
84370 10' x 14' SS  
25420 7' x 10' PL  
42998 10' x 14' AL



70260 10' x 14' FB  
84371 7' x 10' SS  
84372 10' x 14' SS  
25424 7' x 10' PL  
25425 10' x 14' PL  
43001 7' x 10' AL  
43002 10' x 14' AL



125846 7' x 10' SS  
125849 10' x 14' SS  
125845 7' x 10' PL  
125848 10' x 14' PL  
125844 7' x 10' AL  
125847 10' x 14' AL



72428 10' x 14' FB  
22727 7' x 10' PL  
22728 10' x 14' PL

Safety Signs



# Chemical & Hazardous Material Signs

BradyID.com/s34

## Chemical & Hazardous Material Signs (Continued)

Safety Signs



126188	7" x 10"	SS
126191	10" x 14"	SS
126187	7" x 10"	PL
126190	10" x 14"	PL
126186	7" x 10"	AL
126189	10" x 14"	AL



126182	7" x 10"	SS
126185	10" x 14"	SS
126181	7" x 10"	PL
126184	10" x 14"	PL
126180	7" x 10"	AL
126183	10" x 14"	AL



69089	10" x 14"	FB
85458	7" x 10"	SS
85459	10" x 14"	SS
22729	7" x 10"	PL
22730	10" x 14"	PL
41293	7" x 10"	AL
41294	10" x 14"	AL



122823	7" x 10"	FB
70266	10" x 14"	FB
70267	14" x 20"	FB
87763	3-1/2" x 5"	SS
84375	7" x 10"	SS
84376	10" x 14"	SS
25428	7" x 10"	PL
25429	10" x 14"	PL
122407	7" x 10"	AL
43006	10" x 14"	AL

**Popular Sign Materials**

**FB** - Premium Fiberglass (B-120)  
**SS** - Self-Sticking Polyester (B-302)  
**BGSS** - BradyGlo™ Self-Sticking Polyester (B-324)  
**BGPL** - BradyGlo™ Plastic (B-347)  
**PL** - Plastic (B-401)  
**AL** - Aluminum (B-555)

*View all sign materials on page 25.*

**Can't find your sign?**  
*Use the Sign Legend Index on page 498 or take advantage of our custom sign options.*



123631	7" x 10"	SS
123634	10" x 14"	SS
123630	7" x 10"	PL
123633	10" x 14"	PL
123629	7" x 10"	AL
123632	10" x 14"	AL



126212	7" x 10"	SS
126215	10" x 14"	SS
126211	7" x 10"	PL
126214	10" x 14"	PL
126210	7" x 10"	AL
126213	10" x 14"	AL



126200	7" x 10"	SS
126203	10" x 14"	SS
126199	7" x 10"	PL
126202	10" x 14"	PL
126198	7" x 10"	AL
126201	10" x 14"	AL



126206	7" x 10"	SS
126209	10" x 14"	SS
126205	7" x 10"	PL
126208	10" x 14"	PL
126204	7" x 10"	AL
126207	10" x 14"	AL



43507	10" x 14"	AL
-------	-----------	----



126218	10" x 7"	SS
126221	14" x 10"	SS
126217	10" x 7"	PL
126220	14" x 10"	PL
126216	10" x 7"	AL
126219	14" x 10"	AL



70327	10" x 14"	FB
72207	14" x 20"	FB
85161	7" x 10"	SS
85162	10" x 14"	SS
25650	7" x 10"	PL
25651	10" x 14"	PL
43228	10" x 14"	AL



70329	7" x 17"	FB
-------	----------	----



84379	7" x 10"	SS
25430	7" x 10"	PL
25431	10" x 14"	PL
43007	7" x 10"	AL
43008	10" x 14"	AL



73436	14" x 20"	FB
85165	7" x 10"	SS
85166	10" x 14"	SS
25652	7" x 10"	PL
25653	10" x 14"	PL
43230	10" x 14"	AL



75639	10" x 14"	FB
85167	7" x 10"	SS
85168	10" x 14"	SS
25654	7" x 10"	PL
25655	10" x 14"	PL
43231	7" x 10"	AL
43232	10" x 14"	AL



131777	7" x 10"	FB
131778	10" x 14"	FB
131775	7" x 10"	SS
131776	10" x 14"	SS
131773	7" x 10"	PL
131774	10" x 14"	PL
131771	7" x 10"	AL
131772	10" x 14"	AL



71895	14" x 20"	FB
85169	7" x 10"	SS
85170	10" x 14"	SS
25656	7" x 10"	PL
25657	10" x 14"	PL
43233	7" x 10"	AL



70350	7" x 17"	FB
25898	10" x 14"	PL
43475	10" x 14"	AL



122815	7" x 10"	FB
72230	10" x 14"	FB
87764	3-1/2" x 5"	SS
85175	7" x 10"	SS
85176	10" x 14"	SS
122517	7" x 10"	PL
25661	10" x 14"	PL
43237	7" x 10"	AL
43238	10" x 14"	AL



131801	7" x 10"	FB
131802	10" x 14"	FB
131799	7" x 10"	SS
131800	10" x 14"	SS
131797	7" x 10"	PL
131798	10" x 14"	PL
131795	7" x 10"	AL
131796	10" x 14"	AL



123709	7" x 10"	SS
123712	10" x 14"	SS
123708	7" x 10"	PL
123711	10" x 14"	PL
123707	7" x 10"	AL
123710	10" x 14"	AL



71932	10" x 14"	FB
85179	7" x 10"	SS
85180	10" x 14"	SS
25662	7" x 10"	PL
25663	10" x 14"	PL
43239	7" x 10"	AL
43240	10" x 14"	AL



72238	10" x 14"	FB
85181	7" x 10"	SS
85182	10" x 14"	SS
25665	10" x 14"	PL
43241	7" x 10"	AL
43242	10" x 14"	AL



123691	7" x 10"	SS
123694	10" x 14"	SS
123690	7" x 10"	PL
123693	10" x 14"	PL
123689	7" x 10"	AL
123692	10" x 14"	AL



47148	7" x 10"	FB
47024	10" x 14"	FB
75662	14" x 20"	FB
85185	7" x 10"	SS
85186	10" x 14"	SS
25668	7" x 10"	PL
25669	10" x 14"	PL
43245	7" x 10"	AL
43246	10" x 14"	AL



73412	10" x 14"	FB
88359	7" x 10"	SS
88360	10" x 14"	SS
25068	7" x 10"	PL
25069	10" x 14"	PL
42645	7" x 10"	AL
42646	10" x 14"	AL



122825	7" x 10"	FB
72246	10" x 14"	FB
87762	3-1/2" x 5"	SS
85183	7" x 10"	SS
85184	10" x 14"	SS
25666	7" x 10"	PL
25667	10" x 14"	PL
43243	7" x 10"	AL
43244	10" x 14"	AL



131793	7" x 10"	FB
131794	10" x 14"	FB
131791	7" x 10"	SS
131792	10" x 14"	SS
131789	7" x 10"	PL
131790	10" x 14"	PL
131787	7" x 10"	AL
131788	10" x 14"	AL

# Chemical & Hazardous Material Signs

BradyID.com/s34

## Chemical & Hazardous Material Signs (Continued)



71945	10" x 14"	FB
85187	7" x 10"	SS
85188	10" x 14"	SS
25670	7" x 10"	PL
25671	10" x 14"	PL
43247	7" x 10"	AL
43248	10" x 14"	AL



126224	10" x 7"	SS
126227	14" x 10"	SS
126223	10" x 7"	PL
126226	14" x 10"	PL
126222	10" x 7"	AL
126225	14" x 10"	AL



43508	10" x 14"	AL
-------	-----------	----



94996	7" x 10"	FB
95002	7" x 10"	SS
95003	10" x 14"	SS
95000	7" x 10"	PL
95001	10" x 14"	PL
94998	7" x 10"	AL
94999	10" x 14"	AL



76092	10" x 14"	FB
85485	7" x 10"	SS
85486	10" x 14"	SS
22741	7" x 10"	PL
22742	10" x 14"	PL
41305	7" x 10"	AL
41306	10" x 14"	AL



70357	10" x 14"	FB
84387	7" x 10"	SS
84388	10" x 14"	SS
25422	7" x 10"	PL
25423	10" x 14"	PL
42999	7" x 10"	AL
43000	10" x 14"	AL



126230	7" x 10"	SS
126233	10" x 14"	SS
126229	7" x 10"	PL
126232	10" x 14"	PL
126228	7" x 10"	AL
126231	10" x 14"	AL



69265	10" x 14"	FB
85489	7" x 10"	SS
85490	10" x 14"	SS
22745	7" x 10"	PL
22746	10" x 14"	PL
41310	10" x 14"	AL



69264	7" x 17"	FB
-------	----------	----



69275	10" x 14"	FB
84393	7" x 10"	SS
84394	10" x 14"	SS
25436	7" x 10"	PL
25437	10" x 14"	PL
43013	7" x 10"	AL
43014	10" x 14"	AL



72473	10" x 14"	FB
84395	7" x 10"	SS
84396	10" x 14"	SS
25438	7" x 10"	PL
25439	10" x 14"	PL
43015	7" x 10"	AL
43016	10" x 14"	AL



69000	10" x 14"	FB
85493	7" x 10"	SS
22749	7" x 10"	PL
22750	10" x 14"	PL
41313	7" x 10"	AL
41314	10" x 14"	AL



122826	7" x 10"	FB
70372	10" x 14"	FB
84397	7" x 10"	SS
84398	10" x 14"	SS
122519	7" x 10"	PL
25441	10" x 14"	PL
43017	7" x 10"	AL
43018	10" x 14"	AL



131769	7" x 10"	FB
131770	10" x 14"	FB
131767	7" x 10"	SS
131768	10" x 14"	SS
131765	7" x 10"	PL
131766	10" x 14"	PL
131763	7" x 10"	AL
131764	10" x 14"	AL



70373	10" x 14"	FB
84399	7" x 10"	SS
84400	10" x 14"	SS
25442	7" x 10"	PL
25443	10" x 14"	PL
43019	7" x 10"	AL
43020	10" x 14"	AL



126242	7" x 10"	SS
126245	10" x 14"	SS
126241	7" x 10"	PL
126244	10" x 14"	PL
126240	7" x 10"	AL
126243	10" x 14"	AL



85497	7" x 10"	SS
85498	10" x 14"	SS
22751	7" x 10"	PL
22752	10" x 14"	PL
41315	7" x 10"	AL
41316	10" x 14"	AL



85499	7" x 10"	SS
85500	10" x 14"	SS
22753	7" x 10"	PL
22754	10" x 14"	PL
41317	7" x 10"	AL
41318	10" x 14"	AL



126248	7" x 10"	SS
126251	10" x 14"	SS
126247	7" x 10"	PL
126250	10" x 14"	PL
126246	7" x 10"	AL
126249	10" x 14"	AL



131761	7" x 10"	FB
131762	10" x 14"	FB
131759	7" x 10"	SS
131760	10" x 14"	SS
131757	7" x 10"	PL
131758	10" x 14"	PL
131755	7" x 10"	AL
131756	10" x 14"	AL



126236	10" x 7"	SS
126239	14" x 10"	SS
126235	10" x 7"	PL
126238	14" x 10"	PL
126234	10" x 7"	AL
126237	14" x 10"	AL



126254	7" x 10"	SS
126257	10" x 14"	SS
126253	7" x 10"	PL
126256	10" x 14"	PL
126252	7" x 10"	AL
126255	10" x 14"	AL



126260	7" x 10"	SS
126263	10" x 14"	SS
126259	7" x 10"	PL
126262	10" x 14"	PL
126258	7" x 10"	AL
126261	10" x 14"	AL



126266	7" x 10"	SS
126269	10" x 14"	SS
126265	7" x 10"	PL
126268	10" x 14"	PL
126264	7" x 10"	AL
126267	10" x 14"	AL



72489	10" x 14"	FB
84403	7" x 10"	SS
25447	10" x 14"	PL
43023	7" x 10"	AL
43024	10" x 14"	AL



73484	14" x 20"	FB
85191	7" x 10"	SS
85192	10" x 14"	SS
25674	7" x 10"	PL
25675	10" x 14"	PL
43251	7" x 10"	AL



126272	7" x 10"	SS
126275	10" x 14"	SS
126271	7" x 10"	PL
126274	10" x 14"	PL
126270	7" x 10"	AL
126273	10" x 14"	AL



126278	7" x 10"	SS
126281	10" x 14"	SS
126277	7" x 10"	PL
126280	10" x 14"	PL
126276	7" x 10"	AL
126279	10" x 14"	AL



# Chemical & Hazardous Material Signs

BradyID.com/s34

## Chemical & Hazardous Material Signs (Continued)



125870	7" x 10"	SS
125873	10" x 14"	SS
125869	7" x 10"	PL
125872	10" x 14"	PL
125868	7" x 10"	AL
125871	10" x 14"	AL



125858	7" x 10"	SS
125861	10" x 14"	SS
125857	7" x 10"	PL
125860	10" x 14"	PL
125856	7" x 10"	AL
125859	10" x 14"	AL



125864	7" x 10"	SS
125867	10" x 14"	SS
125863	7" x 10"	PL
125866	10" x 14"	PL
125862	7" x 10"	AL
125865	10" x 14"	AL



72503	7" x 10"	FB
84407	7" x 10"	SS
84408	10" x 14"	SS
25448	7" x 10"	PL
25449	10" x 14"	PL
43026	10" x 14"	AL

**Popular Sign Materials**

**FB** - Premium Fiberglass (B-120)  
**SS** - Self-Sticking Polyester (B-302)  
**BGSS** - BradyGlo™ Self-Sticking Polyester (B-324)  
**BGPL** - BradyGlo™ Plastic (B-347)  
**PL** - Plastic (B-401)  
**AL** - Aluminum (B-555)

*View all sign materials on page 25.*

**Can't find your sign?**  
*Use the Sign Legend Index on page 498 or take advantage of our custom sign options.*



131837	7" x 10"	FB
131838	10" x 14"	FB
131835	7" x 10"	SS
131836	10" x 14"	SS
131833	7" x 10"	PL
131834	10" x 14"	PL
131831	7" x 10"	AL
131832	10" x 14"	AL



84409	7" x 10"	SS
25450	7" x 10"	PL
25451	10" x 14"	PL
43027	7" x 10"	AL
43028	10" x 14"	AL



69294	10" x 14"	FB
84411	7" x 10"	SS
84412	10" x 14"	SS
25453	10" x 14"	PL
43029	7" x 10"	AL
43030	10" x 14"	AL



126284	7" x 10"	SS
126287	10" x 14"	SS
126283	7" x 10"	PL
126286	10" x 14"	PL
126282	7" x 10"	AL
126285	10" x 14"	AL



131845	7" x 10"	FB
131846	10" x 14"	FB
131843	7" x 10"	SS
131844	10" x 14"	SS
131841	7" x 10"	PL
131842	10" x 14"	PL
131839	7" x 10"	AL
131840	10" x 14"	AL



69304	7" x 17"	FB
-------	----------	----



43505	10" x 14"	AL
-------	-----------	----



69308	7" x 17"	FB
25910	10" x 14"	PL
43487	10" x 14"	AL



126296	7" x 10"	SS
126299	10" x 14"	SS
126295	7" x 10"	PL
126298	10" x 14"	PL
126294	7" x 10"	AL
126297	10" x 14"	AL



126302	7" x 10"	SS
126305	10" x 14"	SS
126301	7" x 10"	PL
126304	10" x 14"	PL
126300	7" x 10"	AL
126303	10" x 14"	AL



126290	7" x 10"	SS
126293	10" x 14"	SS
126289	7" x 10"	PL
126292	10" x 14"	PL
126288	7" x 10"	AL
126291	10" x 14"	AL



126308	7" x 10"	SS
126311	10" x 14"	SS
126307	7" x 10"	PL
126310	10" x 14"	PL
126306	7" x 10"	AL
126309	10" x 14"	AL

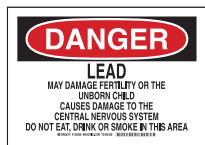

125828	7" x 10"	SS
125831	10" x 14"	SS
125827	7" x 10"	PL
125830	10" x 14"	PL
125826	7" x 10"	AL
125829	10" x 14"	AL



126314	7" x 10"	SS
126317	10" x 14"	SS
126313	7" x 10"	PL
126316	10" x 14"	PL
126312	7" x 10"	AL
126315	10" x 14"	AL



43510	10" x 14"	AL
-------	-----------	----



126320	7" x 10"	SS
126323	10" x 14"	SS
126319	7" x 10"	PL
126322	10" x 14"	PL
126318	7" x 10"	AL
126321	10" x 14"	AL



70419	10" x 14"	FB
84421	10" x 14"	SS
22326	10" x 14"	PL



69337	10" x 14"	FB
85512	7" x 10"	SS
22760	7" x 10"	PL
22761	10" x 14"	PL
41324	7" x 10"	AL
41325	10" x 14"	AL



70423	14" x 20"	FB
84422	7" x 10"	SS
84423	10" x 14"	SS
22327	7" x 10"	PL
22328	10" x 14"	PL
40891	7" x 10"	AL
40892	10" x 14"	AL



123667	7" x 10"	SS
123670	10" x 14"	SS
123666	7" x 10"	PL
123669	10" x 14"	PL
123665	7" x 10"	AL
123668	10" x 14"	AL



126326	7" x 10"	SS
126329	10" x 14"	SS
126325	7" x 10"	PL
126328	10" x 14"	PL
126324	7" x 10"	AL
126327	10" x 14"	AL



72535	10" x 14"	FB
84425	10" x 14"	SS
22329	7" x 10"	PL
22330	10" x 14"	PL



131853	7" x 10"	FB
131854	10" x 14"	FB
84426	7" x 10"	SS
84427	10" x 14"	SS
22331	7" x 10"	PL
22332	10" x 14"	PL
40895	7" x 10"	AL
40896	10" x 14"	AL



126338	7" x 10"	SS
126341	10" x 14"	SS
126337	7" x 10"	PL
126340	10" x 14"	PL
126336	7" x 10"	AL
126339	10" x 14"	AL

Safety Signs

# Chemical & Hazardous Material Signs

BradyID.com/s34

## Chemical & Hazardous Material Signs (Continued)

Safety Signs



126344	7" x 10"	SS
126347	10" x 14"	SS
126343	7" x 10"	PL
126346	10" x 14"	PL
126342	7" x 10"	AL
126345	10" x 14"	AL



69399	10" x 14"	FB
84428	7" x 10"	SS
84429	10" x 14"	SS
22333	7" x 10"	PL
22334	10" x 14"	PL
40897	7" x 10"	AL
40898	10" x 14"	AL



126350	7" x 10"	SS
126353	10" x 14"	SS
126349	7" x 10"	PL
126352	10" x 14"	PL
126348	7" x 10"	AL
126351	10" x 14"	AL



131745	7" x 10"	FB
131746	10" x 14"	FB
131743	7" x 10"	SS
131744	10" x 14"	SS
131741	7" x 10"	PL
131742	10" x 14"	PL
131739	7" x 10"	AL
131740	10" x 14"	AL



69409	7" x 17"	FB
-------	----------	----



84430	7" x 10"	SS
84431	10" x 14"	SS
22335	7" x 10"	PL
22336	10" x 14"	PL
40899	7" x 10"	AL
40900	10" x 14"	AL



126356	7" x 10"	SS
126359	10" x 14"	SS
126355	7" x 10"	PL
126358	10" x 14"	PL
126354	7" x 10"	AL
126357	10" x 14"	AL



84434	3-1/2" x 5"	SS
84435	7" x 10"	SS
84436	10" x 14"	SS
22337	7" x 10"	PL
22338	10" x 14"	PL
40901	7" x 10"	AL
40902	10" x 14"	AL



126374	7" x 10"	SS
126377	10" x 14"	SS
126373	7" x 10"	PL
126376	10" x 14"	PL
126372	7" x 10"	AL
126375	10" x 14"	AL



126368	7" x 10"	SS
126371	10" x 14"	SS
126367	7" x 10"	PL
126370	10" x 14"	PL
126366	7" x 10"	AL
126369	10" x 14"	AL



40904	10" x 14"	AL
69440	10" x 14"	FB
84438	10" x 14"	SS
22339	7" x 10"	PL



126362	7" x 10"	SS
126365	10" x 14"	SS
126361	7" x 10"	PL
126364	10" x 14"	PL
126360	7" x 10"	AL
126363	10" x 14"	AL



126380	7" x 10"	SS
126383	10" x 14"	SS
126379	7" x 10"	PL
126382	10" x 14"	PL
126378	7" x 10"	AL
126381	10" x 14"	AL



131830	7" x 10"	FB
73420	10" x 14"	FB
84439	7" x 10"	SS
84440	10" x 14"	SS
22341	7" x 10"	PL
22342	10" x 14"	PL
40905	7" x 10"	AL
40906	10" x 14"	AL



126386	7" x 10"	SS
126389	10" x 14"	SS
126385	7" x 10"	PL
126388	10" x 14"	PL
126384	7" x 10"	AL
126387	10" x 14"	AL



126398	7" x 10"	SS
126401	10" x 14"	SS
126397	7" x 10"	PL
126400	10" x 14"	PL
126396	7" x 10"	AL
126399	10" x 14"	AL



123655	7" x 10"	SS
123658	10" x 14"	SS
123654	7" x 10"	PL
123657	10" x 14"	PL
123653	7" x 10"	AL
123656	10" x 14"	AL



72587	14" x 20"	FB
85521	7" x 10"	SS
85522	10" x 14"	SS
22764	7" x 10"	PL
22765	10" x 14"	PL
41328	7" x 10"	AL
41329	10" x 14"	AL



87647	7" x 10"	FB
87648	10" x 14"	FB
59397	7" x 10"	SS
50998	10" x 14"	SS
59395	7" x 10"	PL
16840	10" x 14"	PL
16841	10" x 14"	AL



84446	10" x 14"	SS
22343	7" x 10"	PL
40908	10" x 14"	AL



126098	7" x 10"	SS
126101	10" x 14"	SS
126097	7" x 10"	PL
126100	10" x 14"	PL
126096	7" x 10"	AL
126099	10" x 14"	AL



126404	7" x 10"	SS
126407	10" x 14"	SS
126403	7" x 10"	PL
126406	10" x 14"	PL
126402	7" x 10"	AL
126405	10" x 14"	AL



125852	7" x 10"	SS
125855	10" x 14"	SS
125851	7" x 10"	PL
125854	10" x 14"	PL
125850	7" x 10"	AL
125853	10" x 14"	AL



125816	7" x 10"	SS
125819	10" x 14"	SS
125815	7" x 10"	PL
125818	10" x 14"	PL
125814	7" x 10"	AL
125817	10" x 14"	AL



70582	10" x 14"	FB
88627	7" x 10"	SS
88628	10" x 14"	SS
25222	7" x 10"	PL
25223	10" x 14"	PL
42799	7" x 10"	AL
42800	10" x 14"	AL



84457	7" x 10"	SS
84458	10" x 14"	SS
22349	7" x 10"	PL
22350	10" x 14"	PL
40913	10" x 14"	AL
40914	10" x 14"	AL



70585	10" x 14"	FB
84459	7" x 10"	SS
22351	7" x 10"	PL



69558	10" x 14"	FB
84461	7" x 10"	SS
84462	10" x 14"	SS
22353	7" x 10"	PL
22354	10" x 14"	PL



126416	7" x 10"	SS
126419	10" x 14"	SS
126415	7" x 10"	PL
126418	10" x 14"	PL
126414	7" x 10"	AL
126417	10" x 14"	AL



126410	7" x 10"	SS
126413	10" x 14"	SS
126409	7" x 10"	PL
126412	10" x 14"	PL
126408	7" x 10"	AL
126411	10" x 14"	AL



# Chemical & Hazardous Material Signs

BradyID.com/s34

## Chemical & Hazardous Material Signs (Continued)

Safety Signs

**NOTICE**  
"RIGHT TO KNOW"  
INFORMATION  
AVAILABLE IN  
THIS OFFICE

84473	7" x 10"	SS
22365	7" x 10"	PL
22366	10" x 14"	PL

**NOTICE**  
ALL DRUMS IN THIS  
AREA MUST BE  
GROUNDED

126428	7" x 10"	SS
126431	10" x 14"	SS
126427	7" x 10"	PL
126430	10" x 14"	PL
126426	7" x 10"	AL
126429	10" x 14"	AL

**NOTICE**  
CHAIN  
ALL CYLINDERS  
SECURELY

70239	10" x 14"	FB
85531	7" x 10"	SS
85532	10" x 14"	SS
22768	7" x 10"	PL
22769	10" x 14"	PL
41332	7" x 10"	AL
41333	10" x 14"	AL

**NOTICE**  
CHEMICAL SPILLS  
MUST BE REPORTED  
IMMEDIATELY

126434	7" x 10"	SS
126437	10" x 14"	SS
126433	7" x 10"	PL
126436	10" x 14"	PL
126432	7" x 10"	AL
126435	10" x 14"	AL

**Popular Sign Materials**  
**FB** - Premium Fiberglass (B-120)  
**SS** - Self-Sticking Polyester (B-302)  
**BGSS** - BradyGlo™ Self-Sticking Polyester (B-324)  
**BGPL** - BradyGlo™ Plastic (B-347)  
**PL** - Plastic (B-401)  
**AL** - Aluminum (B-555)  
*View all sign materials on page 25.*  
**Can't find your sign?**  
*Use the Sign Legend Index on page 498 or take advantage of our custom sign options.*

**NOTICE**  
CYLINDERS  
NOT CONNECTED  
MUST BE CAPPED

85533	7" x 10"	SS
85534	10" x 14"	SS
22770	7" x 10"	PL
22771	10" x 14"	PL
41334	7" x 10"	AL
41335	10" x 14"	AL

**NOTICE**  
DO NOT DUMP  
CHEMICALS DOWN  
THIS DRAIN

70270	10" x 14"	FB
84463	7" x 10"	SS
84464	10" x 14"	SS
22355	7" x 10"	PL
22356	10" x 14"	PL
40920	10" x 14"	AL

**NOTICE**  
DRUMS MUST  
BE LABELED

85535	7" x 10"	SS
85536	10" x 14"	SS
25734	7" x 10"	PL
25735	10" x 14"	PL
43311	7" x 10"	AL
43312	10" x 14"	AL

**NOTICE**  
EMPTY DRUMS  
ONLY

126440	7" x 10"	SS
126443	10" x 14"	SS
126439	7" x 10"	PL
126442	10" x 14"	PL
126438	7" x 10"	AL
126441	10" x 14"	AL

**NOTICE**  
FOR CHEMICAL  
STORAGE ONLY  
NO FOOD  
PERMITTED

126452	7" x 10"	SS
126455	10" x 14"	SS
126451	7" x 10"	PL
126454	10" x 14"	PL
126450	7" x 10"	AL
126453	10" x 14"	AL

**NOTICE**  
IMPROPER DISPOSAL  
OF CHEMICALS  
IS PUNISHABLE BY  
FINES AND IMPRISONMENT

126446	7" x 10"	SS
126449	10" x 14"	SS
126445	7" x 10"	PL
126448	10" x 14"	PL
126444	7" x 10"	AL
126447	10" x 14"	AL

**NOTICE**  
KEEP  
CYLINDERS  
CHAINED

131885	7" x 10"	FB
131886	10" x 14"	FB
131883	7" x 10"	SS
131884	10" x 14"	SS
131881	7" x 10"	PL
131882	10" x 14"	PL
131879	7" x 10"	AL
131880	10" x 14"	AL

**NOTICE**  
LABEL ALL  
DRUMS

126458	7" x 10"	SS
126461	10" x 14"	SS
126457	7" x 10"	PL
126460	10" x 14"	PL
126456	7" x 10"	AL
126459	10" x 14"	AL

**NOTICE**  
MATERIAL SAFETY  
DATA SHEETS  
& THE WRITTEN HAZARD  
COMMUNICATION PROGRAM  
LOCATED HERE

126470	7" x 10"	SS
126473	10" x 14"	SS
126469	7" x 10"	PL
126472	10" x 14"	PL
126468	7" x 10"	AL
126471	10" x 14"	AL

**NOTICE**  
MATERIAL SAFETY  
DATA SHEETS  
AVAILABLE  
UPON REQUEST

126464	7" x 10"	SS
126467	10" x 14"	SS
126463	7" x 10"	PL
126466	10" x 14"	PL
126462	7" x 10"	AL
126465	10" x 14"	AL

**NOTICE**  
MSDS AND  
THE WRITTEN HAZARDOUS  
COMMUNICATION PROGRAM  
FOR THIS WORK PLACE IS  
LOCATED IN FOREMAN'S OFFICE

70430	10" x 14"	FB
84466	10" x 14"	SS
22357	7" x 10"	PL
22358	10" x 14"	PL
40922	10" x 14"	AL

**NOTICE**  
NON-HAZARDOUS  
MATERIALS  
ONLY

126476	7" x 10"	SS
126479	10" x 14"	SS
126475	7" x 10"	PL
126478	10" x 14"	PL
126474	7" x 10"	AL
126477	10" x 14"	AL

**NOTICE**  
NON-POTABLE  
WATER

69407	10" x 14"	FB
84467	7" x 10"	SS
84468	10" x 14"	SS
22359	7" x 10"	PL
22360	10" x 14"	PL
40923	7" x 10"	AL
40924	10" x 14"	AL

**NOTICE**  
NON-POTABLE WATER  
NOT FOR DRINKING  
OR COOKING

95277	7" x 17"	FB
-------	----------	----

**NOTICE**  
NON-POTABLE WATER  
NOT FOR DRINKING  
OR COOKING USE

72546	7" x 10"	FB
84471	7" x 10"	SS
84472	10" x 14"	SS
22363	7" x 10"	PL
22364	10" x 14"	PL
40927	7" x 10"	AL
40928	10" x 14"	AL

**NOTICE**  
NON-POTABLE WATER  
NOT TO BE USED FOR DRINKING,  
WASHING OR COOKING PURPOSES

84469	7" x 10"	SS
22361	7" x 10"	PL
22362	10" x 14"	PL
40925	7" x 10"	AL
40926	10" x 14"	AL

**NOTICE**  
STORE FULL GAS  
CYLINDERS HERE

126482	7" x 10"	SS
126485	10" x 14"	SS
126481	7" x 10"	PL
126484	10" x 14"	PL
126480	7" x 10"	AL
126483	10" x 14"	AL

**NOTICE**  
THIS WATER  
IS SAFE  
TO DRINK

126488	7" x 10"	SS
126491	10" x 14"	SS
126487	7" x 10"	PL
126490	10" x 14"	PL
126486	7" x 10"	AL
126489	10" x 14"	AL

**OXYGEN**  
NO SMOKING  
NO OPEN FLAMES

73418	10" x 14"	FB
88455	7" x 10"	SS
88456	10" x 14"	SS
25138	7" x 10"	PL
42715	7" x 10"	AL

**SAFETY FIRST**  
IF YOU GET CHEMICALS  
ON YOUR BODY OR EYES  
WASH THOROUGHLY  
WITH PLENTY OF WATER

74616	14" x 20"	FB
84476	10" x 14"	SS
22367	7" x 10"	PL
22368	10" x 14"	PL

**SAFETY FIRST**  
WEAR FACE SHIELDS,  
RUBBER GLOVES  
AND APRONS WHEN  
WORKING WITH ACIDS

74464	14" x 20"	FB
84477	7" x 10"	SS
84478	10" x 14"	SS
22369	7" x 10"	PL
40933	7" x 10"	AL
40934	10" x 14"	AL



# Chemical & Hazardous Material Signs

BradyID.com/s34

## Chemical & Hazardous Material Signs (Continued)



126500	7" x 10"	SS
126503	10" x 14"	SS
126499	7" x 10"	PL
126502	10" x 14"	PL
126498	7" x 10"	AL
126501	10" x 14"	AL



126512	7" x 10"	SS
126515	10" x 14"	SS
126511	7" x 10"	PL
126514	10" x 14"	PL
126510	7" x 10"	AL
126513	10" x 14"	AL



126608	7" x 10"	SS
126611	10" x 14"	SS
126607	7" x 10"	PL
126610	10" x 14"	PL
126606	7" x 10"	AL
126609	10" x 14"	AL



126518	7" x 10"	SS
126521	10" x 14"	SS
126517	7" x 10"	PL
126520	10" x 14"	PL
126516	7" x 10"	AL
126519	10" x 14"	AL



126524	7" x 10"	SS
126527	10" x 14"	SS
126523	7" x 10"	PL
126526	10" x 14"	PL
126522	7" x 10"	AL
126525	10" x 14"	AL



126530	7" x 10"	SS
126533	10" x 14"	SS
126529	7" x 10"	PL
126532	10" x 14"	PL
126528	7" x 10"	AL
126531	10" x 14"	AL



125786	7" x 10"	SS
125789	10" x 14"	SS
125785	7" x 10"	PL
125788	10" x 14"	PL
125784	7" x 10"	AL
125787	10" x 14"	AL

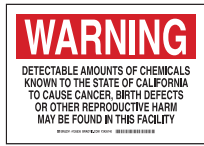

126536	7" x 10"	SS
126539	10" x 14"	SS
126535	7" x 10"	PL
126538	10" x 14"	PL
126534	7" x 10"	AL
126537	10" x 14"	AL



126542	7" x 10"	SS
126545	10" x 14"	SS
126541	7" x 10"	PL
126544	10" x 14"	PL
126540	7" x 10"	AL
126543	10" x 14"	AL



69573	10" x 14"	FB
84483	7" x 10"	SS
84484	10" x 14"	SS
22371	7" x 10"	PL
22372	10" x 14"	PL
40935	7" x 10"	AL
40936	10" x 14"	AL



126548	7" x 10"	SS
126551	10" x 14"	SS
126547	7" x 10"	PL
126550	10" x 14"	PL
126546	7" x 10"	AL
126549	10" x 14"	AL



126554	7" x 10"	SS
126557	10" x 14"	SS
126553	7" x 10"	PL
126556	10" x 14"	PL
126552	7" x 10"	AL
126555	10" x 14"	AL



126560	7" x 10"	SS
126563	10" x 14"	SS
126559	7" x 10"	PL
126562	10" x 14"	PL
126558	7" x 10"	AL
126561	10" x 14"	AL



69585	10" x 14"	FB
85547	7" x 10"	SS
85548	10" x 14"	SS
25738	7" x 10"	PL
25739	10" x 14"	PL
43315	7" x 10"	AL
43316	10" x 14"	AL



126566	7" x 10"	SS
126569	10" x 14"	SS
126565	7" x 10"	PL
126568	10" x 14"	PL
126564	7" x 10"	AL
126567	10" x 14"	AL



126614	7" x 10"	SS
126617	10" x 14"	SS
126613	7" x 10"	PL
126616	10" x 14"	PL
126612	7" x 10"	AL
126615	10" x 14"	AL



126572	7" x 10"	SS
126575	10" x 14"	SS
126571	7" x 10"	PL
126574	10" x 14"	PL
126570	7" x 10"	AL
126573	10" x 14"	AL



126578	7" x 10"	SS
126581	10" x 14"	SS
126577	7" x 10"	PL
126580	10" x 14"	PL
126576	7" x 10"	AL
126579	10" x 14"	AL



126584	7" x 10"	SS
126587	10" x 14"	SS
126583	7" x 10"	PL
126586	10" x 14"	PL
126582	7" x 10"	AL
126585	10" x 14"	AL



122895	7" x 10"	FB
76085	10" x 14"	FB
87767	3-1/2" x 5"	SS
85549	7" x 10"	SS
85550	10" x 14"	SS
25740	7" x 10"	PL
25741	10" x 14"	PL
43317	7" x 10"	AL
43318	10" x 14"	AL



85551	14" x 3"	SS
-------	----------	----



126590	7" x 10"	SS
126593	10" x 14"	SS
126589	7" x 10"	PL
126592	10" x 14"	PL
126588	7" x 10"	AL
126591	10" x 14"	AL



126596	7" x 10"	SS
126599	10" x 14"	SS
126595	7" x 10"	PL
126598	10" x 14"	PL
126594	7" x 10"	AL
126597	10" x 14"	AL



69604	10" x 14"	FB
84487	7" x 10"	SS
84488	10" x 14"	SS
22373	7" x 10"	PL
22374	10" x 14"	PL
40937	7" x 10"	AL
40938	10" x 14"	AL



69615	10" x 14"	FB
84491	7" x 10"	SS
84492	10" x 14"	SS
22377	7" x 10"	PL
22378	10" x 14"	PL
40942	10" x 14"	AL



126620	10" x 7"	SS
126623	14" x 10"	SS
126619	10" x 7"	PL
126622	14" x 10"	PL
126618	10" x 7"	AL
126621	14" x 10"	AL

Safety Signs



# Chemical & Hazardous Material Signs

BradyID.com/s34

## Chemical & Hazardous Material Signs (Continued)

**ACETYLENE  
EMPTY  
CYLINDERS**

125567	7" x 10"	SS
125570	10" x 14"	SS
125566	7" x 10"	PL
125569	10" x 14"	PL
125565	7" x 10"	AL
125568	10" x 14"	AL

**ACETYLENE  
FLAMMABLE GAS  
NO SMOKING  
NO OPEN FLAMES**

125561	7" x 10"	SS
125564	10" x 14"	SS
125560	7" x 10"	PL
125563	10" x 14"	PL
125559	7" x 10"	AL
125562	10" x 14"	AL

**ACETYLENE  
FULL  
CYLINDERS**

125573	7" x 10"	SS
125576	10" x 14"	SS
125572	7" x 10"	PL
125575	10" x 14"	PL
125571	7" x 10"	AL
125574	10" x 14"	AL

**ACETYLENE  
NO SMOKING  
NO OPEN FLAMES**

84493	7" x 10"	SS
84494	10" x 14"	SS
40943	7" x 10"	AL

### Popular Sign Materials

**FB** - Premium Fiberglass (B-120)  
**SS** - Self-Sticking Polyester (B-302)  
**BGSS** - BradyGlo™ Self-Sticking Polyester (B-324)  
**BGPL** - BradyGlo™ Plastic (B-347)  
**PL** - Plastic (B-401)  
**AL** - Aluminum (B-555)  
*View all sign materials on page 25.*

**Can't find your sign?**  
*Use the Sign Legend Index on page 498 or  
 take advantage of our custom sign options.*

**ARGON  
EMPTY  
CYLINDERS**

125579	7" x 10"	SS
125582	10" x 14"	SS
125578	7" x 10"	PL
125581	10" x 14"	PL
125577	7" x 10"	AL
125580	10" x 14"	AL

**ARGON  
EMPTY  
CYLINDERS**

17942	7" x 10"	SS
-------	----------	----

**ARGON  
FULL  
CYLINDERS**

125585	7" x 10"	SS
125588	10" x 14"	SS
125584	7" x 10"	PL
125587	10" x 14"	PL
125583	7" x 10"	AL
125586	10" x 14"	AL

**ARGON  
FULL  
CYLINDERS**

17943	7" x 10"	SS
-------	----------	----

**BATTERY ROOM  
ABSOLUTELY  
NO SMOKING  
SAFETY GLASSES  
REQUIRED**

125591	7" x 10"	SS
125594	10" x 14"	SS
125590	7" x 10"	PL
125593	10" x 14"	PL
125589	7" x 10"	AL
125592	10" x 14"	AL

**BREATHING AIR  
EMPTY  
CYLINDERS**

125597	7" x 10"	SS
125600	10" x 14"	SS
125596	7" x 10"	PL
125599	10" x 14"	PL
125595	7" x 10"	AL
125598	10" x 14"	AL

**BREATHING AIR  
EMPTY  
CYLINDERS**

17944	7" x 10"	SS
-------	----------	----

**BREATHING AIR  
FULL  
CYLINDERS**

125603	7" x 10"	SS
125606	10" x 14"	SS
125602	7" x 10"	PL
125605	10" x 14"	PL
59404	7" x 10"	AL
125604	10" x 14"	AL

**BREATHING AIR  
FULL  
CYLINDERS**

17945	7" x 10"	SS
-------	----------	----

**CALIFORNIA  
PROPOSITION 65 WARNING**  
 Diesel engine exhaust and some of its  
 constituents are known to the State  
 of California to cause cancer, birth defects,  
 and other reproductive harm.

125609	7" x 10"	SS
125612	10" x 14"	SS
125608	7" x 10"	PL
125611	10" x 14"	PL
125607	7" x 10"	AL
125610	10" x 14"	AL

**CANCER SUSPECT  
AGENT AREA  
PROTECTIVE  
EQUIPMENT REQUIRED  
AUTHORIZED  
PERSONNEL ONLY**

25883	10" x 14"	PL
-------	-----------	----

**CAUTION - PROPANE**

125705	7" x 17"	SS
125704	7" x 17"	PL
125703	7" x 17"	AL

**CHEMICAL  
GOGGLES  
REQUIRED**

84497	7" x 10"	SS
84498	10" x 14"	SS
22380	7" x 10"	PL
22381	10" x 14"	PL

**CHEMICAL  
SPILLAGE  
MUST BE REPORTED  
IMMEDIATELY TO  
PLANT SUPERVISORY  
PERSONNEL**

125615	7" x 10"	SS
125618	10" x 14"	SS
125614	7" x 10"	PL
125617	10" x 14"	PL
125613	7" x 10"	AL
125616	10" x 14"	AL

**CLEAN  
EMPTY  
DRUMS**

125621	7" x 10"	SS
125624	10" x 14"	SS
125620	7" x 10"	PL
125623	10" x 14"	PL
125619	7" x 10"	AL
125622	10" x 14"	AL





















69794	7" x 7"	FB
88491	7" x 7"	SS
25157	7" x 10"	PL
42734	7" x 10"	AL



125627	7" x 10"	SS
125630	10" x 14"	SS
125626	7" x 10"	PL
125629	10" x 14"	PL
125625	7" x 10"	AL
125628	10" x 14"	AL



## Chemical & Hazardous Material Signs (Continued)

					
73490 10" x 14" FB 85562 7" x 10" SS 85563 10" x 14" SS	60563 7" x 10" SS 60533 7" x 10" PL 60504 7" x 10" AL	96090 7" x 10" SS 60349 10" x 14" SS 60348 10" x 14" PL 96087 10" x 14" AL	125633 7" x 10" SS 125636 10" x 14" SS 125632 7" x 10" PL 125635 10" x 14" PL 125631 7" x 10" AL 125634 10" x 14" AL	95005 10" x 14" FB 95010 7" x 10" SS 95011 10" x 14" SS 95008 7" x 10" PL 95009 10" x 14" PL 95006 7" x 10" AL 95007 10" x 14" AL	125639 7" x 10" SS 125642 10" x 14" SS 125638 7" x 10" PL 125641 10" x 14" PL 125637 7" x 10" AL 125640 10" x 14" AL
					
17955 7" x 10" SS	125663 7" x 10" SS 125666 10" x 14" SS 125662 7" x 10" PL 125665 10" x 14" PL 125661 7" x 10" AL 125664 10" x 14" AL	125669 7" x 10" SS 125672 10" x 14" SS 125668 7" x 10" PL 125671 10" x 14" PL 125667 7" x 10" AL 125670 10" x 14" AL	70317 10" x 14" FB 85564 7" x 10" SS 85565 10" x 14" SS 25745 7" x 10" PL 43322 7" x 10" AL	<del>26V870</del> 7" x 10" FB 131902 10" x 14" FB <del>26V837</del> 7" x 10" SS 131900 10" x 14" SS <del>26V887</del> 7" x 10" PL 131898 10" x 14" PL <del>26V838</del> 7" x 10" AL 131896 10" x 14" AL	17956 7" x 10" SS
					
125651 7" x 10" SS 125654 10" x 14" SS 125650 7" x 10" PL 125653 10" x 14" PL 125649 7" x 10" AL 125652 10" x 14" AL	125645 7" x 10" SS 125648 10" x 14" SS 125644 7" x 10" PL 125647 10" x 14" PL 125643 7" x 10" AL 125646 10" x 14" AL	125657 7" x 10" SS 125660 10" x 14" SS 125656 7" x 10" PL 125659 10" x 14" PL 125655 7" x 10" AL 125658 10" x 14" AL	69221 10" x 10" FB 88500 10" x 10" SS 25165 10" x 14" PL	90710 10" x 7" BGPL	69252 10" x 10" FB 88506 10" x 10" SS 42748 10" x 14" AL

## CUSTOM SIGNS

Brady's "Same as Stock" custom sign pricing makes it easy to create signs unique to your facility.

Brady understands that sometimes you need a sign that is unique to your own facility. With Brady's wide variety of custom sign options, we have the ability to create a sign with exactly the message you need, in the material and size you want.

- Custom text
- Custom graphics
- Common sizes
- Variety of materials
- No minimum order
- Fast turnaround

View page 194 for more information.

# Chemical & Hazardous Material Signs

BradyID.com/s34

## Chemical & Hazardous Material Signs (Continued)

Safety Signs



17952 7" x 10" SS



125681 7" x 10" SS  
125684 10" x 14" SS  
125680 7" x 10" PL  
125683 10" x 14" PL  
125679 7" x 10" AL  
125682 10" x 14" AL

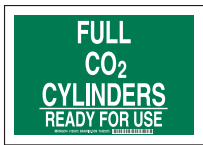

125675 7" x 10" SS  
125678 10" x 14" SS  
125674 7" x 10" PL  
125677 10" x 14" PL  
125673 7" x 10" AL  
125676 10" x 14" AL



70356 10" x 14" FB  
85566 7" x 10" SS  
85567 10" x 14" SS  
25746 7" x 10" PL  
43323 7" x 10" AL

**Popular Sign Materials**

**FB** - Premium Fiberglass (B-120)  
**SS** - Self-Sticking Polyester (B-302)  
**BGSS** - BradyGlo™ Self-Sticking Polyester (B-324)  
**BGPL** - BradyGlo™ Plastic (B-347)  
**PL** - Plastic (B-401)  
**AL** - Aluminum (B-555)

*View all sign materials on page 25.*

**Can't find your sign?**  
*Use the Sign Legend Index on page 498 or take advantage of our custom sign options.*



131893 7" x 10" FB  
131894 10" x 14" FB  
131891 7" x 10" SS  
131892 10" x 14" SS  
131889 7" x 10" PL  
131890 10" x 14" PL  
131887 7" x 10" AL  
131888 10" x 14" AL



17953 7" x 10" SS



125693 7" x 10" SS  
125696 10" x 14" SS  
125692 7" x 10" PL  
125695 10" x 14" PL  
125691 7" x 10" AL  
125694 10" x 14" AL



125699 7" x 10" SS  
125702 10" x 14" SS  
125698 7" x 10" PL  
125701 10" x 14" PL  
125697 7" x 10" AL  
125700 10" x 14" AL



125687 7" x 10" SS  
125690 10" x 14" SS  
125686 7" x 10" PL  
125689 10" x 14" PL  
125685 7" x 10" AL  
125688 10" x 14" AL



84507 7" x 10" SS  
84508 10" x 14" SS  
22385 7" x 10" PL  
40949 7" x 10" AL



60568 7" x 10" SS



30673 7" x 10" SS  
30670 10" x 14" AL



125708 7" x 10" SS  
125711 10" x 14" SS  
125707 7" x 10" PL  
125710 10" x 14" PL  
125706 7" x 10" AL  
125709 10" x 14" AL



17946 7" x 10" SS



125714 7" x 10" SS  
125717 10" x 14" SS  
125713 7" x 10" PL  
125716 10" x 14" PL  
125712 7" x 10" AL  
125715 10" x 14" AL



17947 7" x 10" SS



125720 7" x 10" SS  
125723 10" x 14" SS  
125719 7" x 10" PL  
125722 10" x 14" PL  
125718 7" x 10" AL  
125721 10" x 14" AL

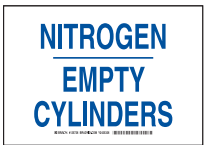

125726 7" x 10" SS  
125729 10" x 14" SS  
125725 7" x 10" PL  
125728 10" x 14" PL  
125724 7" x 10" AL  
125727 10" x 14" AL



17948 7" x 10" SS



125732 7" x 10" SS  
125735 10" x 14" SS  
125731 7" x 10" PL  
125734 10" x 14" PL  
125730 7" x 10" AL  
125733 10" x 14" AL



17949 7" x 10" SS



125738 7" x 10" SS  
125741 10" x 14" SS  
125737 7" x 10" PL  
125740 10" x 14" PL  
125736 7" x 10" AL  
125739 10" x 14" AL



125744 7" x 10" SS  
125747 10" x 14" SS  
125743 7" x 10" PL  
125746 10" x 14" PL  
125742 7" x 10" AL  
125745 10" x 14" AL



17954 7" x 10" SS



125555 7" x 10" SS  
125558 10" x 14" SS  
125554 7" x 10" PL  
125557 10" x 14" PL  
125553 7" x 10" AL  
125556 10" x 14" AL



17950 7" x 10" B-946



17951 7" x 10" SS

# Chemical & Hazardous Material Signs

BradyID.com/s34

## Chemical & Hazardous Material Signs (Continued)



125882	7" x 10"	SS
125885	10" x 14"	SS
125881	7" x 10"	PL
125884	10" x 14"	PL
125880	7" x 10"	AL
125883	10" x 14"	AL



69442	10" x 10"	FB
88522	10" x 10"	SS



125756	7" x 10"	SS
125759	10" x 14"	SS
125755	7" x 10"	PL
125758	10" x 14"	PL
125754	7" x 10"	AL
125757	10" x 14"	AL



125774	10" x 7"	SS
125777	14" x 10"	SS
125773	10" x 7"	PL
125776	14" x 10"	PL
125772	10" x 7"	AL
125775	14" x 10"	AL



30672	7" x 10"	SS
30669	10" x 14"	AL



123859	7" x 10"	SS
123862	10" x 14"	SS
123858	7" x 10"	PL
123861	10" x 14"	PL
123857	7" x 10"	AL
123860	10" x 14"	AL



43979	7" x 10"	SS
-------	----------	----



125762	7" x 10"	SS
125765	10" x 14"	SS
125761	7" x 10"	PL
125764	10" x 14"	PL
125760	7" x 10"	AL
125763	10" x 14"	AL



30674	7" x 10"	SS
30671	10" x 14"	AL



43502	10" x 14"	AL
-------	-----------	----



69801	7" x 7"	FB
88529	7" x 7"	SS
25190	7" x 10"	PL
42767	7" x 10"	AL



122890	7" x 10"	FB
122750	10" x 14"	FB
43983	7" x 10"	SS
122608	10" x 14"	SS
122554	7" x 10"	PL
122489	10" x 14"	PL
60350	10" x 14"	AL



125768	7" x 10"	SS
125771	10" x 14"	SS
125767	7" x 10"	PL
125770	10" x 14"	PL
125766	7" x 10"	AL
125769	10" x 14"	AL



125780	7" x 10"	SS
125783	10" x 14"	SS
125779	7" x 10"	PL
125782	10" x 14"	PL
125778	7" x 10"	AL
125781	10" x 14"	AL



84511	7" x 10"	SS
22386	7" x 10"	PL

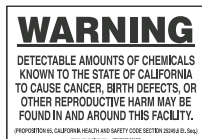

122798	7" x 10"	FB
58621	10" x 14"	FB
89015	5" x 6"	SS
122637	7" x 10"	SS
89097	10" x 14"	SS
122505	7" x 10"	PL
122469	10" x 14"	PL
122394	7" x 10"	AL
122343	10" x 14"	AL



80716	5" x 6"	SS
80717	10" x 14"	SS



125798	7" x 10"	SS
125801	10" x 14"	SS
125797	7" x 10"	PL
125800	10" x 14"	PL
125796	7" x 10"	AL
125799	10" x 14"	AL



125792	7" x 10"	SS
125795	10" x 14"	SS
125791	7" x 10"	PL
125794	10" x 14"	PL
125790	7" x 10"	AL
125793	10" x 14"	AL



125804	7" x 10"	SS
125807	10" x 14"	SS
125803	7" x 10"	PL
125806	10" x 14"	PL
125802	7" x 10"	AL
125805	10" x 14"	AL



Safety Signs



# Chemical & Hazardous Material Signs

BradyID.com/s34

## Hazardous Material Signs

- Most signs include the NFPA Code Number 704M for Hazardous Information
- Clear identification of hazardous chemicals
- Resistant to vapors or spills
- Red legend on white background

### Chemical information from the Department of Transportation Guidebook for Hazardous Materials Incidents (SOT 5800.4-1987)

Catalog #	Size	Material	Legend
48893	10" x 7"	FB	1, 1, 1, Trichloroethane
48840	10" x 7"	FB	Acetic Acid, Glacial
48841	10" x 7"	FB	Acetone
48842	10" x 7"	FB	Acetylene
48843	10" x 7"	FB	Acrylic Acid
48845	10" x 7"	FB	Ammonium Hydroxide
48846	10" x 7"	FB	Anhydrous Ammonia
48847	10" x 7"	FB	Benzaldehyde
48848	10" x 7"	FB	Benzene
48849	10" x 7"	FB	Bromine
48850	10" x 7"	FB	Butane
48851	10" x 7"	FB	Butanol
48852	10" x 7"	FB	Calcium Chloride
48853	10" x 7"	FB	Calcium Hypochlorite
48854	10" x 7"	FB	Carbon Dioxide
48855	10" x 7"	FB	Carbon Disulfide
48856	10" x 7"	FB	Carbon Tetrachloride
48857	10" x 7"	FB	Caustic Potash (Potassium Hydroxide)
48858	10" x 7"	FB	Caustic Soda (Sodium Hydroxide)
48859	10" x 7"	FB	Chlorine
48860	10" x 7"	FB	Chloroform
48861	10" x 7"	FB	Chromic Acid, Solid Chromium Anhydride
48862	10" x 7"	FB	Diesel Fuel
48863	10" x 7"	FB	Ethyl Acetate
48864	10" x 7"	FB	Ethyl Alcohol (Ethanol)
48865	10" x 7"	FB	Ethylene Glycol
48866	10" x 7"	FB	Formic Acid
48867	10" x 7"	FB	Fuel Oil
48868	10" x 7"	FB	Gasoline
48869	10" x 7"	FB	Heptane

Catalog #	Size	Material	Legend
48870	10" x 7"	FB	Hexane
48871	10" x 7"	FB	Hydrochloric Acid
48872	10" x 7"	FB	Hydrofluoric Acid
48874	10" x 7"	FB	Hydrofluorosilicic Acid
48873	10" x 7"	FB	Hydrogen Peroxide, 52%
48875	10" x 7"	FB	Isopropanol
48876	10" x 7"	FB	Isopropyl Acetate
48877	10" x 7"	FB	Kerosene
48878	10" x 7"	FB	Mercury
48879	10" x 7"	FB	Methanol
48880	10" x 7"	FB	Methyl Ethyl Ketone
48881	10" x 7"	FB	Muriatic Acid
48882	10" x 7"	FB	Nitric Acid
48883	10" x 7"	FB	Nitrogen, Liquid
48884	10" x 7"	FB	Oxygen, Compressed
48885	10" x 7"	FB	Phenol
48886	10" x 7"	FB	Phosphoric Acid
48887	10" x 7"	FB	Potassium Hydroxide
48888	10" x 7"	FB	Potassium Perchlorate
48889	10" x 7"	FB	Potassium Permanganate
48890	10" x 7"	FB	Propane Gas
48891	10" x 7"	FB	Sodium Hydroxide
48892	10" x 7"	FB	Toluene
48899	7" x 10"	FB	Trichloroethylene
48894	10" x 7"	FB	Turpentine
48895	10" x 7"	FB	Unleaded Gasoline
48896	10" x 7"	FB	Vinyl Acetate
48897	10" x 7"	FB	Vinyl Chloride
48898	10" x 7"	FB	Xylene

Safety Signs

### ACETONE

**POTENTIAL HAZARDS**

**FIRE OR EXPLOSION**  
Flammable/combustible material; may be ignited by heat, sparks or flames. Vapors may travel to a source of ignition and flash back.  
Container may explode in heat of fire. Vapor explosion hazard indoors, outdoors or in sewers.  
Runoff to sewer may create fire or explosion hazard.

**HEALTH HAZARDS**  
May be poisonous if inhaled or absorbed through skin. Vapors may cause dizziness or suffocation. Contact may irritate or burn skin and eyes. Fire may produce irritating or poisonous gases. Runoff from fire control or diltion water may cause pollution.

**EMERGENCY ACTION**  
Keep unnecessary people away; isolate hazard area and deny entry.  
Stay upwind; keep out of low areas.  
Self-contained breathing apparatus (SCBA) and structural firefighter's protective clothing will provide limited protection.  
**Isolate for 1/2 mile in all directions if tank car or truck is involved in fire.**  
**CALL CHEMTREC AT 1-800-424-9300 FOR EMERGENCY ASSISTANCE.** If water pollution occurs, notify the appropriate authorities.  
**FIRE**  
**Small Fires:** Dry chemical, CO<sub>2</sub>, Halon, water spray or alcohol foam.  
**Large Fires:** Water spray, fog or alcohol foam is recommended.  
Move container from fire area if you can do it without risk.  
Cool containers that are exposed to flames with water from the side until well after fire is out. Stay away from ends of tanks.  
For massive fire in cargo area, use unmanned hose holder or monitor nozzles; if this is impossible, withdraw from area and let fire burn.  
Withdraw immediately in case of rising sound from venting safety device or any deterioration of tank due to fire.

**POTENTIAL HAZARDS**

**EXPLOSION HEALTH HAZARDS**  
Inhalable; may be ignited by heat, flames, or electrical sparks.  
May be a source of ignition and explosion in heat of fire.  
Explosion hazard indoors, outdoors or in sewers.

**EMERGENCY ACTION**  
Keep unnecessary people away; isolate hazard area and deny entry.  
Stay upwind; keep out of low areas, and ventilate before entering.  
Use self-contained breathing apparatus and structural firefighter's protective clothing will provide limited protection.  
Move in all directions if tank car is involved in fire.  
**Emergency Response Telephone Shipping Paper First Aid:** Shipping label or no answer, TREC AT 1-800-424-9300.  
**Small Spills:** Take up with sand or other noncombustible absorbent material and place into containers for later disposal.  
**Large Spills:** Dike far ahead of liquid spill for later disposal.  
**FIRST AID**  
Move victim to fresh air and call emergency medical care; if not breathing, give artificial respiration; if breathing is difficult, give oxygen. In case of contact with material, immediately flush eyes with running water for at least 15 minutes. Wash skin with soap and water. Remove and isolate contaminated clothing and shoes at the site.

**BUTANE**

**POTENTIAL HAZARDS**

**EXPLOSION HEALTH HAZARDS**  
Inhalable; may be ignited by heat, flames, or electrical sparks.  
May be a source of ignition and explosion in heat of fire.  
Explosion hazard indoors, outdoors or in sewers.

**EMERGENCY ACTION**  
Keep unnecessary people away; isolate hazard area and deny entry.  
Stay upwind; keep out of low areas, and ventilate before entering.  
Use self-contained breathing apparatus and structural firefighter's protective clothing will provide limited protection.  
Move in all directions if tank car is involved in fire.  
**Emergency Response Telephone Shipping Paper First Aid:** Shipping label or no answer, TREC AT 1-800-424-9300.  
**Small Spills:** Take up with sand or other noncombustible absorbent material and place into containers for later disposal.  
**Large Spills:** Dike far ahead of liquid spill for later disposal.  
**FIRST AID**  
Move victim to fresh air and call emergency medical care; if not breathing, give artificial respiration; if breathing is difficult, give oxygen. In case of frostbite, thaw frosted parts with water. Keep victim quiet and maintain normal body temperature.

### GASOLINE

**POTENTIAL HAZARDS**

**EXPLOSION HEALTH HAZARDS**  
Inhalable; may be ignited by heat, flames, or electrical sparks.  
May be a source of ignition and explosion in heat of fire.  
Explosion hazard indoors, outdoors or in sewers.

**EMERGENCY ACTION**  
Keep unnecessary people away; isolate hazard area and deny entry.  
Stay upwind; keep out of low areas, and ventilate before entering.  
Use self-contained breathing apparatus and structural firefighter's protective clothing will provide limited protection.  
Move in all directions if tank car is involved in fire.  
**Emergency Response Telephone Shipping Paper First Aid:** Shipping label or no answer, TREC AT 1-800-424-9300.  
**Small Spills:** Take up with sand or other noncombustible absorbent material and place into containers for later disposal.  
**Large Spills:** Dike far ahead of liquid spill for later disposal.  
**FIRST AID**  
Move victim to fresh air and call emergency medical care; if not breathing, give artificial respiration; if breathing is difficult, give oxygen. In case of contact with material, immediately flush eyes with running water for at least 15 minutes. Wash skin with soap and water. Remove and isolate contaminated clothing and shoes at the site.

**POTENTIAL HAZARDS**

**EXPLOSION**  
Inhalable; may be ignited by heat, flames, or electrical sparks.  
May be a source of ignition and explosion in heat of fire.  
Explosion hazard indoors, outdoors or in sewers.

**HEALTH HAZARDS**  
May be poisonous if inhaled or absorbed through skin. Vapors may cause dizziness or suffocation. Contact may irritate or burn skin and eyes. Fire may produce irritating or poisonous gases. Runoff from fire control or diltion water may cause pollution.

**EMERGENCY ACTION**  
Keep unnecessary people away; isolate hazard area and deny entry.  
Stay upwind; keep out of low areas, and ventilate before entering.  
Use self-contained breathing apparatus (SCBA) and structural firefighter's protective clothing will provide limited protection.  
**Isolate for 1/2 mile in all directions if tank car or truck is involved in fire.**  
**CALL CHEMTREC AT 1-800-424-9300 FOR EMERGENCY ASSISTANCE.** If water pollution occurs, notify the appropriate authorities.  
**FIRE**  
**Small Fires:** Dry chemical, CO<sub>2</sub>, or Halon, or standard foam.  
**Large Fires:** Water spray, fog or standard foam is recommended.  
Move container from fire area if you can do it without risk.  
Cool containers that are exposed to flames in the side until well after fire is out from ends of tanks.  
For massive fire in cargo area, use unmanned hose holder or monitor nozzles; if this is impossible, withdraw from area and let fire burn.  
Withdraw immediately in case of rising sound safety device or any deterioration of tank due to fire.

**POTENTIAL HAZARDS**

**EXPLOSION HEALTH HAZARDS**  
Inhalable; may cause dizziness or suffocation. Contact will cause severe frostbite. Fire may produce irritating or poisonous gases.

**EMERGENCY ACTION**  
Keep unnecessary people away; isolate hazard area and deny entry.  
Stay upwind; keep out of low areas, and ventilate before entering.  
Use self-contained breathing apparatus and structural firefighter's protective clothing will provide limited protection.  
Move in all directions if tank car is involved in fire.  
**Emergency Response Telephone Shipping Paper First Aid:** Shipping label or no answer, TREC AT 1-800-424-9300.  
**Small Spills:** Take up with sand or other noncombustible absorbent material and place into containers for later disposal.  
**Large Spills:** Dike far ahead of liquid spill for later disposal.  
**FIRST AID**  
Move victim to fresh air and call emergency medical care; if not breathing, give artificial respiration; if breathing is difficult, give oxygen. In case of frostbite, thaw frosted parts with water. Keep victim quiet and maintain normal body temperature.

Examples of 10" x 7" Hazardous Material Signs

# Chemical & Hazardous Material DOT Placards

BradyID.com/s34

## Chemical & Hazardous Material DOT Vehicle Placards

- Placards meet D.O.T. requirements 49CFR Part 172
- Placards have square corners and no holes

### Placard Material Information

**PTG** - Economical 1.75 lb. polycoated tagboard - exceed D.O.T.'s 30 day weather requirement (B-101)  
**SS** - Self-Sticking Vinyl - may be applied directly to your vehicle (B-946)  
**FB** - Premium Fiberglass offer over 15 years outdoor durability. (B-120)  
 Use with Brady slide-in Placard Holders. (Sold separately)  
 View all sign materials on page 79.



Hazard Division 1.1 Compatibility Group  
A, B, C, D, E, F, G, J or L

63300	10.75' x 10.75'	SS	EXPLOSIVE 1.1A
63371	10.75' x 10.75'	PTG	EXPLOSIVE 1.1B
63336	10.75' x 10.75'	FB	EXPLOSIVE 1.1B
63301	10.75' x 10.75'	SS	EXPLOSIVE 1.1B
63372	10.75' x 10.75'	PTG	EXPLOSIVE 1.1C
63337	10.75' x 10.75'	FB	EXPLOSIVE 1.1C
63302	10.75' x 10.75'	SS	EXPLOSIVE 1.1C
63373	10.75' x 10.75'	PTG	EXPLOSIVE 1.1D
63303	10.75' x 10.75'	SS	EXPLOSIVE 1.1D
63339	10.75' x 10.75'	FB	EXPLOSIVE 1.1E
63304	10.75' x 10.75'	SS	EXPLOSIVE 1.1E
63375	10.75' x 10.75'	PTG	EXPLOSIVE 1.1F
63340	10.75' x 10.75'	FB	EXPLOSIVE 1.1F
63376	10.75' x 10.75'	PTG	EXPLOSIVE 1.1G
63341	10.75' x 10.75'	FB	EXPLOSIVE 1.1G
63306	10.75' x 10.75'	SS	EXPLOSIVE 1.1G
63377	10.75' x 10.75'	PTG	EXPLOSIVE 1.1J
63342	10.75' x 10.75'	FB	EXPLOSIVE 1.1J
63307	10.75' x 10.75'	SS	EXPLOSIVE 1.1J
63378	10.75' x 10.75'	PTG	EXPLOSIVES 1.1L
63308	10.75' x 10.75'	SS	EXPLOSIVES 1.1L



Hazard Division 1.2 Compatibility Group  
B, C, D, E, F, G, H, J, K or L

63344	10.75' x 10.75'	FB	EXPLOSIVE 1.2B
63380	10.75' x 10.75'	PTG	EXPLOSIVE 1.2C
63345	10.75' x 10.75'	FB	EXPLOSIVE 1.2C
63310	10.75' x 10.75'	SS	EXPLOSIVE 1.2C
63381	10.75' x 10.75'	PTG	EXPLOSIVE 1.2D
63346	10.75' x 10.75'	FB	EXPLOSIVE 1.2D
63311	10.75' x 10.75'	SS	EXPLOSIVE 1.2D
63347	10.75' x 10.75'	FB	EXPLOSIVE 1.2E
63312	10.75' x 10.75'	SS	EXPLOSIVE 1.2E
63383	10.75' x 10.75'	PTG	EXPLOSIVE 1.2F
63348	10.75' x 10.75'	FB	EXPLOSIVE 1.2F
63313	10.75' x 10.75'	SS	EXPLOSIVE 1.2F
63384	10.75' x 10.75'	PTG	EXPLOSIVE 1.2G
63349	10.75' x 10.75'	FB	EXPLOSIVE 1.2G
63314	10.75' x 10.75'	SS	EXPLOSIVE 1.2G
63385	10.75' x 10.75'	PTG	EXPLOSIVE 1.2H
63350	10.75' x 10.75'	FB	EXPLOSIVE 1.2H
63386	10.75' x 10.75'	PTG	EXPLOSIVE 1.2J
63351	10.75' x 10.75'	FB	EXPLOSIVE 1.2J
63316	10.75' x 10.75'	SS	EXPLOSIVE 1.2J
63387	10.75' x 10.75'	PTG	EXPLOSIVE 1.2K
63352	10.75' x 10.75'	FB	EXPLOSIVE 1.2K
63317	10.75' x 10.75'	SS	EXPLOSIVE 1.2K
63353	10.75' x 10.75'	FB	EXPLOSIVES 1.2L
63318	10.75' x 10.75'	SS	EXPLOSIVES 1.2L



Hazard Division 1.3 Compatibility Group  
C, F, G, H, J, K or L

63389	10.75' x 10.75'	PTG	EXPLOSIVE 1.3C
63354	10.75' x 10.75'	FB	EXPLOSIVE 1.3C
63390	10.75' x 10.75'	PTG	EXPLOSIVE 1.3F
63355	10.75' x 10.75'	FB	EXPLOSIVE 1.3F
63320	10.75' x 10.75'	SS	EXPLOSIVE 1.3F
63356	10.75' x 10.75'	FB	EXPLOSIVE 1.3G
63321	10.75' x 10.75'	SS	EXPLOSIVE 1.3G
63392	10.75' x 10.75'	PTG	EXPLOSIVE 1.3H
63357	10.75' x 10.75'	FB	EXPLOSIVE 1.3H
63322	10.75' x 10.75'	SS	EXPLOSIVE 1.3H
63393	10.75' x 10.75'	PTG	EXPLOSIVE 1.3J
63358	10.75' x 10.75'	FB	EXPLOSIVE 1.3J
63323	10.75' x 10.75'	SS	EXPLOSIVE 1.3J
63394	10.75' x 10.75'	PTG	EXPLOSIVE 1.3K
63359	10.75' x 10.75'	FB	EXPLOSIVE 1.3K
63324	10.75' x 10.75'	SS	EXPLOSIVE 1.3K
63395	10.75' x 10.75'	PTG	EXPLOSIVES 1.3L
63360	10.75' x 10.75'	FB	EXPLOSIVES 1.3L
63325	10.75' x 10.75'	SS	EXPLOSIVES 1.3L



Hazard Division 1.4 Compatibility Group  
B, C, D, E, F, G or S

63396	10.75' x 10.75'	PTG	EXPLOSIVE 1.4B
63361	10.75' x 10.75'	FB	EXPLOSIVE 1.4B
63326	10.75' x 10.75'	SS	EXPLOSIVE 1.4B
63362	10.75' x 10.75'	FB	EXPLOSIVE 1.4C
63327	10.75' x 10.75'	SS	EXPLOSIVE 1.4C
63363	10.75' x 10.75'	FB	EXPLOSIVE 1.4D
63328	10.75' x 10.75'	SS	EXPLOSIVE 1.4D
63399	10.75' x 10.75'	PTG	EXPLOSIVE 1.4E
63364	10.75' x 10.75'	FB	EXPLOSIVE 1.4E
63400	10.75' x 10.75'	PTG	EXPLOSIVE 1.4F
63365	10.75' x 10.75'	FB	EXPLOSIVE 1.4F
63366	10.75' x 10.75'	FB	EXPLOSIVE 1.4G
63331	10.75' x 10.75'	SS	EXPLOSIVE 1.4G
63332	10.75' x 10.75'	SS	EXPLOSIVES 1.4S



Hazard Division 1.5 Compatibility Group  
D

63403	10.75' x 10.75'	PTG	1.5 BLASTING AGENTS D 1
63368	10.75' x 10.75'	FB	1.5 BLASTING AGENTS D 1
63333	10.75' x 10.75'	SS	1.5 BLASTING AGENTS D 1



Hazard Division 1.6 Compatibility Group  
N

63404	10.75' x 10.75'	PTG	1.6 EXPLOSIVE N 1
63369	10.75' x 10.75'	FB	1.6 EXPLOSIVE N 1
63334	10.75' x 10.75'	SS	1.6 EXPLOSIVE N 1



# Chemical & Hazardous Material DOT Placards

BradyID.com/s34

## Chemical & Hazardous Material DOT Vehicle Placards (Continued)

### Class 2:

60391 10.75' x 10.75' PTG 60407 10.75' x 10.75' FB 60375 10.75' x 10.75' SS	60421 10.75' x 10.75' FB	63439 10.75' x 10.75' PTG	63436 10.75' x 10.75' FB 63406 10.75' x 10.75' SS	60428 10.75' x 10.75' PTG 60423 10.75' x 10.75' FB 60433 10.75' x 10.75' SS	60434 10.75' x 10.75' SS

### Class 3:

60394 10.75' x 10.75' PTG 60410 10.75' x 10.75' FB 60379 10.75' x 10.75' SS	63444 10.75' x 10.75' PTG 63423 10.75' x 10.75' FB 63410 10.75' x 10.75' SS	63443 10.75' x 10.75' PTG 63422 10.75' x 10.75' FB 63409 10.75' x 10.75' SS	63411 10.75' x 10.75' SS

### Class 4:

60398 10.75' x 10.75' PTG 60414 10.75' x 10.75' FB 60382 10.75' x 10.75' SS	60413 10.75' x 10.75' FB	60412 10.75' x 10.75' FB 60380 10.75' x 10.75' SS	63448 10.75' x 10.75' PTG 63414 10.75' x 10.75' SS	63446 10.75' x 10.75' PTG 63425 10.75' x 10.75' FB 63412 10.75' x 10.75' SS	63447 10.75' x 10.75' PTG 63426 10.75' x 10.75' FB

### Class 5:

60383 10.75' x 10.75' SS	63449 10.75' x 10.75' PTG 63428 10.75' x 10.75' FB 63415 10.75' x 10.75' SS	60400 10.75' x 10.75' PTG 60416 10.75' x 10.75' FB 60384 10.75' x 10.75' SS	63429 10.75' x 10.75' FB

### Class 6:

60390 10.75' x 10.75' SS	60402 10.75' x 10.75' PTG	63452 10.75' x 10.75' PTG 63431 10.75' x 10.75' FB 63418 10.75' x 10.75' SS	60427 10.75' x 10.75' FB	60431 10.75' x 10.75' PTG 60426 10.75' x 10.75' FB 60436 10.75' x 10.75' SS	60425 10.75' x 10.75' FB 60435 10.75' x 10.75' SS

### Class 7:

63419 10.75' x 10.75' SS

### Class 8:

60403 10.75' x 10.75' PTG 60419 10.75' x 10.75' FB 60387 10.75' x 10.75' SS	63454 10.75' x 10.75' PTG 63433 10.75' x 10.75' FB 63420 10.75' x 10.75' SS

### Class 9:

60404 10.75' x 10.75' PTG 60388 10.75' x 10.75' SS	63455 10.75' x 10.75' PTG 63434 10.75' x 10.75' FB 63421 10.75' x 10.75' SS

### Mixed Loads

63212 10.75' x 10.75' PTG 76259 10.75' x 10.75' FB 76394 10.75' x 10.75' SS



# Chemical & Hazardous Material DOT Placards

BradyID.com/s34

## Flip-Style Vehicle Placards



## Cargo Tanks Placards

- Flipping numerals give you the flexibility to set-up any 4-digit identification number in seconds
- Durable, heavy-duty aluminum frame assures stability in the wind and saves money on placard replacement costs
- Legend Set 1 includes:
  - Blank
  - Flammable Gas 2
  - Non-Flammable Gas 2
  - Oxygen 2
  - Inhalation Hazard 2
- Legend Set 2 includes:
  - Blank
  - Flammable 3
  - Corrosive 8
  - Combustible 3
  - Poison 6

Catalog #	Description	Qty.
63213	One-Piece Frame; Legend Set 1	1
63214	One-Piece Frame; Legend Set 2	1

## Welding Supply and Medical Van Placards

- Standard flip-file system contain multiple panels in one frame
- Self-contained placards slide easily on for aluminum hinges
- Four stainless steel fasteners securely lock in your chosen legend
- Deep-formed aluminum frame provides stability and excellent wind protection
- Includes legends:
  - Blank
  - Flammable Gas 2
  - Non-Flammable Gas 2
  - Oxygen 2

Catalog #	Description	Qty.
63200	One-Piece Frame	1

## General Commodities Placards

- Approved for use by private and fleet carriers
- Split frame available for roll up doors
- Self-contained placards slide easily on for aluminum hinges
- Four stainless steel fasteners securely lock in your chosen legend
- Deep-formed aluminum frame provides stability and excellent wind protection
- Includes legends:
  - Blank
  - Blasting Agents 1.5d
  - Corrosive 8
  - Dangerous
  - Dangerous When Wet 4
  - Explosive 1.4
  - Flammable 2
  - Flammable Gas 2
  - Flammable Solid 4
  - Inhalation 2
  - Inhalation 6
  - Misc. 9
  - Non-Flammable Gas 2
  - Organic Peroxide 5.2
  - Oxidizer 5.1
  - Poison 6
  - Spontaneously Combustible 4

Catalog #	Description	Qty.
59955	One-piece Frame	1
59956	Split-Frame for roll up doors	1

## Vehicle Conspicuity Tape

- Enhance visibility and detection
- Made of diamond grade B-752 with presealed edges
- Guaranteed to perform for a min. 7 years
- Kits available that contain enough material to mark a trailer per the NHTSA Regulation

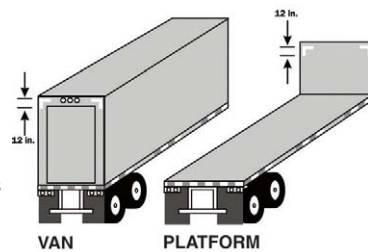

## Tape Rolls

Catalog #	Description	Size	Qty.
76434	DOT-C2 Solid White	2" x 50'	1 roll
76436	DOT-C2 Alternating 7" White / 11" Red	2" x 50'	1 roll

## Tape Kits

Catalog #	Trailer Size	Kit Contents					Squeegee & Instructions
		2" x 75' White/Red Roll	2" x 18" Solid White Strips (sides)	2" x 12" Red/White Strips (corners)	2" x 90" Red/White Strips (bumper/door)	1.5" x 90" Red/White Strips (underride)	
76437	All Sizes	1 roll	-	-	-	-	1 each
76438	53' - 57'	-	36 strips	4 strips	1 strip	1 strip	1 each
76439	45' - 48'	-	32 strips	4 strips	1 strip	1 strip	1 each



## Placard Holders

- Slide-in placard holder mounts vehicle placards to your vehicle
- Features easy-off guides over the retaining clip so placards slide easily

Catalog #	Description	Qty.
60142	Split Frame	1
60141	Frame without clipped corners	1
60143	Frame with 2 clipped corners	1



# Confined Space Signs

BradyID.com/s34

## Confined Space Signs

Brady offers a variety of confined space signs to help you identify your confined workspace areas including tanks, electrical rooms and enclosures. These confined space signs include warnings for authorized or permit entry areas. Brady's confined space signs also communicate required protective gear, including gloves, eye protection or hearing protection.

### Popular Sign Materials

- FB** - Premium Fiberglass (B-120)
  - SS** - Self-Sticking Polyester (B-302)
  - BGSS** - BradyGlo™ Self-Sticking Polyester (B-324)
  - BGPL** - BradyGlo™ Plastic (B-347)
  - PL** - Plastic (B-401)
  - AL** - Aluminum (B-555)
- View all sign materials on page 25.*

### Can't find your sign?

*Use the Sign Legend Index on page 498 or take advantage of our custom sign options.*

Safety Signs

 <p>126698 7" x 10" SS 126701 10" x 14" SS 126697 7" x 10" PL 126700 10" x 14" PL 126696 7" x 10" AL 126699 10" x 14" AL</p>	 <p>76077 10" x 14" FB 84516 10" x 14" SS 40953 7" x 10" AL 40954 10" x 14" AL</p>	 <p>126704 10" x 7" SS 126707 14" x 10" SS 126703 10" x 7" PL 126706 14" x 10" PL 126702 10" x 7" AL 126705 14" x 10" AL</p>	 <p>126710 7" x 10" SS 126713 10" x 14" SS 126709 7" x 10" PL 126712 10" x 14" PL 126708 7" x 10" AL 126711 10" x 14" AL</p>	 <p>124267 7" x 10" SS 124270 10" x 14" SS 124266 7" x 10" PL 124269 10" x 14" PL 124265 7" x 10" AL 124268 10" x 14" AL</p>	 <p>126716 7" x 10" SS 126719 10" x 14" SS 126715 7" x 10" PL 126718 10" x 14" PL 126714 7" x 10" AL 126717 10" x 14" AL</p>
 <p>126728 7" x 10" SS 126731 10" x 14" SS 126727 7" x 10" PL 126730 10" x 14" PL 126726 7" x 10" AL 126729 10" x 14" AL</p>	 <p>124288 7" x 10" SS 124291 10" x 14" SS 124287 7" x 10" PL 124290 10" x 14" PL 124286 7" x 10" AL 124289 10" x 14" AL</p>	 <p>126722 7" x 10" SS 126725 10" x 14" SS 126721 7" x 10" PL 126724 10" x 14" PL 126720 7" x 10" AL 126723 10" x 14" AL</p>	 <p>126734 7" x 10" SS 126737 10" x 14" SS 126733 7" x 10" PL 126736 10" x 14" PL 126732 7" x 10" AL 126735 10" x 14" AL</p>	 <p>126740 7" x 10" SS 126743 10" x 14" SS 126739 7" x 10" PL 126742 10" x 14" PL 126738 7" x 10" AL 126741 10" x 14" AL</p>	 <p>126752 7" x 10" SS 126755 10" x 14" SS 126751 7" x 10" PL 126754 10" x 14" PL 126750 7" x 10" AL 126753 10" x 14" AL</p>
 <p>22409 7" x 10" PL 22410 10" x 14" PL 40973 7" x 10" AL 40974 10" x 14" AL</p>	 <p>84542 10" x 14" SS 22411 7" x 10" PL 22412 10" x 14" PL 40975 7" x 10" AL</p>	 <p>124237 7" x 10" SS 124240 10" x 14" SS 124236 7" x 10" PL 124239 10" x 14" PL 124235 7" x 10" AL 124238 10" x 14" AL</p>	 <p>126746 7" x 10" SS 126749 10" x 14" SS 126745 7" x 10" PL 126748 10" x 14" PL 126744 7" x 10" AL 126747 10" x 14" AL</p>	 <p>126758 7" x 10" SS 126761 10" x 14" SS 126757 7" x 10" PL 126760 10" x 14" PL 126756 7" x 10" AL 126759 10" x 14" AL</p>	 <p>95012 7" x 10" FB 95013 10" x 14" FB 95018 7" x 10" SS 60569 10" x 14" SS 95015 7" x 10" PL 60535 10" x 14" PL 95014 7" x 10" AL 60506 10" x 14" AL</p>
 <p>131682 10" x 14" PL 131679 7" x 10" AL 131680 10" x 14" AL</p>	 <p>126812 7" x 10" SS 126815 10" x 14" SS 126811 7" x 10" PL 126814 10" x 14" PL 126810 7" x 10" AL 126813 10" x 14" AL</p>	 <p>126782 7" x 10" SS 126785 10" x 14" SS 126781 7" x 10" PL 126784 10" x 14" PL 126780 7" x 10" AL 126783 10" x 14" AL</p>	 <p>123715 7" x 10" SS 123718 10" x 14" SS 123714 7" x 10" PL 123717 10" x 14" PL 123713 7" x 10" AL 123716 10" x 14" AL</p>	 <p>126764 7" x 10" SS 126767 10" x 14" SS 126763 7" x 10" PL 126766 10" x 14" PL 126762 7" x 10" AL 126765 10" x 14" AL</p>	 <p>126794 7" x 10" SS 126797 10" x 14" SS 126793 7" x 10" PL 126796 10" x 14" PL 126792 7" x 10" AL 126795 10" x 14" AL</p>

## Confined Space Signs (Continued)



70248	7" x 10"	FB
70249	10" x 14"	FB
87748	3-1/2" x 5"	SS
84562	7" x 10"	SS
84563	10" x 14"	SS
22424	7" x 10"	PL
22425	10" x 14"	PL
40988	7" x 10"	AL
40989	10" x 14"	AL



87674	7" x 10"	FB
87675	10" x 14"	FB
19197	10" x 14"	SS
19193	7" x 10"	PL
19199	10" x 14"	PL
19194	7" x 10"	AL
19200	10" x 14"	AL



122812	7" x 10"	FB
122787	14" x 10"	FB
65909	20" x 14"	FB
122649	7" x 10"	SS
84564	14" x 10"	SS
122516	7" x 10"	PL
22426	14" x 10"	PL
122405	7" x 10"	AL



126818	7" x 10"	SS
126821	10" x 14"	SS
126817	7" x 10"	PL
126820	10" x 14"	PL
126816	7" x 10"	AL
126819	10" x 14"	AL

**! OSHA Regulation**

**Permit Required Confined Space, Do Not Enter 1910.146(c)(2)**  
Exposed employees must be informed of the existence and location of and the danger posed by permit-required confined spaces through the posting of danger signs or by any other equally effective means. A sign reading "DANGER – PERMIT – REQUIRED CONFINED SPACE, DO NOT ENTER" or using other similar language satisfies the requirement.

**Accident Prevention 1910.145(c)(2)**  
Caution signs shall be used only to warn against potential hazards or to caution against unsafe practices. All employees shall be instructed that caution signs indicate a possible hazard against which proper precaution should be taken.



123643	7" x 10"	SS
123646	10" x 14"	SS
123642	7" x 10"	PL
123645	10" x 14"	PL
123641	7" x 10"	AL
123644	10" x 14"	AL



126800	7" x 10"	SS
126803	10" x 14"	SS
126799	7" x 10"	PL
126802	10" x 14"	PL
126798	7" x 10"	AL
126801	10" x 14"	AL



40991	10" x 7"	AL
40992	14" x 10"	AL



122811	7" x 10"	FB
122713	10" x 14"	FB
73408	14" x 20"	FB
87773	3-1/2" x 5"	SS
84567	7" x 10"	SS
84568	10" x 14"	SS
22429	7" x 10"	PL
22430	10" x 14"	PL
40993	7" x 10"	AL
40994	10" x 14"	AL



40995	10" x 7"	AL
40996	14" x 10"	AL



126788	7" x 10"	SS
126791	10" x 14"	SS
126787	7" x 10"	PL
126790	10" x 14"	PL
126786	7" x 10"	AL
126789	10" x 14"	AL



123649	7" x 10"	SS
123652	10" x 14"	SS
123648	7" x 10"	PL
123651	10" x 14"	PL
123647	7" x 10"	AL
123650	10" x 14"	AL



126776	7" x 10"	SS
126779	10" x 14"	SS
126775	7" x 10"	PL
126778	10" x 14"	PL
126774	7" x 10"	AL
126777	10" x 14"	AL



123673	10" x 7"	SS
123676	14" x 10"	SS
123672	10" x 7"	PL
123675	14" x 10"	PL
123671	10" x 7"	AL
123674	14" x 10"	AL



126770	7" x 10"	SS
126773	10" x 14"	SS
126769	7" x 10"	PL
126772	10" x 14"	PL
126768	7" x 10"	AL
126771	10" x 14"	AL



# Confined Space Signs

BradyID.com/s34

## Confined Space Signs (Continued)



126836	7" x 10"	SS
126839	10" x 14"	SS
126835	7" x 10"	PL
126838	10" x 14"	PL
126834	7" x 10"	AL
126837	10" x 14"	AL



131693	7" x 10"	FB
131694	10" x 14"	FB
131691	7" x 10"	SS
131692	10" x 14"	SS
131689	7" x 10"	PL
131690	10" x 14"	PL
131687	7" x 10"	AL
131688	10" x 14"	AL



126806	7" x 10"	SS
126809	10" x 14"	SS
126805	7" x 10"	PL
126808	10" x 14"	PL
126804	7" x 10"	AL
126807	10" x 14"	AL



126830	7" x 10"	SS
126833	10" x 14"	SS
126829	7" x 10"	PL
126832	10" x 14"	PL
126828	7" x 10"	AL
126831	10" x 14"	AL

### Popular Sign Materials

**FB** - Premium Fiberglass (B-120)  
**SS** - Self-Sticking Polyester (B-302)  
**BGSS** - BradyGlo™ Self-Sticking Polyester (B-324)  
**BGPL** - BradyGlo™ Plastic (B-347)  
**PL** - Plastic (B-401)  
**AL** - Aluminum (B-555)

*View all sign materials on page 25.*

**Can't find your sign?**  
*Use the Sign Legend Index on page 498 or take advantage of our custom sign options.*



123607	7" x 10"	SS
123610	10" x 14"	SS
123606	7" x 10"	PL
123609	10" x 14"	PL
123605	7" x 10"	AL
123608	10" x 14"	AL



40999	7" x 10"	AL
-------	----------	----



123625	7" x 10"	SS
123628	10" x 14"	SS
123624	7" x 10"	PL
123627	10" x 14"	PL
123623	7" x 10"	AL
123626	10" x 14"	AL



126824	7" x 10"	SS
126827	10" x 14"	SS
126823	7" x 10"	PL
126826	10" x 14"	PL
126822	7" x 10"	AL
126825	10" x 14"	AL



65948	7" x 10"	FB
65817	10" x 14"	FB
87768	3-1/2" x 5"	SS
65950	7" x 10"	SS
65949	10" x 14"	SS
25920	7" x 10"	PL
25921	10" x 14"	PL
43517	7" x 10"	AL
43518	10" x 14"	AL



84575	7" x 10"	SS
22437	7" x 10"	PL
22438	10" x 14"	PL
41001	7" x 10"	AL
41002	10" x 14"	AL



84577	7" x 10"	SS
41003	7" x 10"	AL



82595	7" x 10"	SS
82596	10" x 14"	SS
20027	7" x 10"	PL
20028	10" x 14"	PL
49069	7" x 10"	AL
49070	10" x 14"	AL
60241	10" x 14"	FB



65910	10" x 14"	FB
22441	7" x 10"	PL
41006	10" x 14"	AL

## Confined Space Manhole Cover Signs

- Polystyrene manhole signs fit under most standard manhole covers
- Sign is visible only when the cover is removed from the confined space entry point



43760	Fits 21"-30" dia.
47204	Fits 30.5"-42" dia.



43759	Fits 21"-30" dia.
47198	Fits 30.5"-42" dia.



43754	Fits 21"-30" dia.
47196	Fits 30.5"-42" dia.



43753	Fits 21"-30" dia.
-------	-------------------



43758	Fits 21"-30" dia.
-------	-------------------



43747	Fits 21"-30" dia.
-------	-------------------



43748	Fits 21"-30" dia.
-------	-------------------

## Construction Site Signs

Brady construction signs are a highly visible, effective way to warn employees, pedestrians and visitors of the potential dangers of construction areas. These signs indicate a wide range of warnings, including employee locations, temporary road closings and more. Brady also offers additional traffic control signs to identify traffic lane closings, shoulder closings, and other construction areas.



126866	7" x 10"	SS
126869	10" x 14"	SS
126865	7" x 10"	PL
126868	10" x 14"	PL
126864	7" x 10"	AL
126867	10" x 14"	AL



126872	7" x 10"	SS
126875	10" x 14"	SS
126871	7" x 10"	PL
126874	10" x 14"	PL
126870	7" x 10"	AL
126873	10" x 14"	AL



60570	10" x 14"	SS
95351	7" x 10"	PL
60536	10" x 14"	PL
95352	7" x 10"	AL
60507	10" x 14"	AL



126878	7" x 10"	SS
126881	10" x 14"	SS
126877	7" x 10"	PL
126880	10" x 14"	PL
126876	7" x 10"	AL
126879	10" x 14"	AL



126884	7" x 10"	SS
126887	10" x 14"	SS
126883	7" x 10"	PL
126886	10" x 14"	PL
126882	7" x 10"	AL
126885	10" x 14"	AL



126890	7" x 10"	SS
126893	10" x 14"	SS
126889	7" x 10"	PL
126892	10" x 14"	PL
126888	7" x 10"	AL
126891	10" x 14"	AL



126896	7" x 10"	SS
126899	10" x 14"	SS
126895	7" x 10"	PL
126898	10" x 14"	PL
126894	7" x 10"	AL
126897	10" x 14"	AL



126902	7" x 10"	SS
126905	10" x 14"	SS
126901	7" x 10"	PL
126904	10" x 14"	PL
126900	7" x 10"	AL
126903	10" x 14"	AL



126908	7" x 10"	SS
126911	10" x 14"	SS
126907	7" x 10"	PL
126910	10" x 14"	PL
126906	7" x 10"	AL
126909	10" x 14"	AL



126914	7" x 10"	SS
126917	10" x 14"	SS
126913	7" x 10"	PL
126916	10" x 14"	PL
126912	7" x 10"	AL
126915	10" x 14"	AL



126932	7" x 10"	SS
126935	10" x 14"	SS
126931	7" x 10"	PL
126934	10" x 14"	PL
126930	7" x 10"	AL
126933	10" x 14"	AL



126920	7" x 10"	SS
126923	10" x 14"	SS
126919	7" x 10"	PL
126922	10" x 14"	PL
126918	7" x 10"	AL
126921	10" x 14"	AL



126926	7" x 10"	SS
126929	10" x 14"	SS
126925	7" x 10"	PL
126928	10" x 14"	PL
126924	7" x 10"	AL
126927	10" x 14"	AL



126848	7" x 10"	SS
126851	10" x 14"	SS
126847	7" x 10"	PL
126850	10" x 14"	PL
126846	7" x 10"	AL
126849	10" x 14"	AL



126842	7" x 10"	SS
126845	10" x 14"	SS
126841	7" x 10"	PL
126844	10" x 14"	PL
126840	7" x 10"	AL
126843	10" x 14"	AL



126854	7" x 10"	SS
126857	10" x 14"	SS
126853	7" x 10"	PL
126856	10" x 14"	PL
126852	7" x 10"	AL
126855	10" x 14"	AL



126860	7" x 10"	SS
126863	10" x 14"	SS
126859	7" x 10"	PL
126862	10" x 14"	PL
126858	7" x 10"	AL
126861	10" x 14"	AL

## Custom Signs

Brady's "Same as Stock" custom sign pricing makes it easy to create signs unique to your facility.

View page 194 for more information.



# Door Signs

BradyID.com/s34

## Door Signs

Brady door signs doors that must be kept closed, emergency exits, fire exits, and more. With bright, noticeable colors and a wide range of sizes and materials, Brady has a sign for every door in your facility.

Safety Signs

### Popular Sign Materials

- FB** - Premium Fiberglass (B-120)
  - SS** - Self-Sticking Polyester (B-302)
  - BGSS** - BradyGlo™ Self-Sticking Polyester (B-324)
  - BGPL** - BradyGlo™ Plastic (B-347)
  - PL** - Plastic (B-401)
  - AL** - Aluminum (B-555)
- View all sign materials on page 25.*

### Can't find your sign?

*Use the Sign Legend Index on page 498 or take advantage of our custom sign options.*



70245	10" x 14"	FB
84692	10" x 14"	SS
22505	7" x 10"	PL
41069	7" x 10"	AL
41070	10" x 14"	AL



95272	7" x 17"	FB
-------	----------	----



84695	7" x 10"	SS
84696	10" x 14"	SS
22507	7" x 10"	PL
22508	10" x 14"	PL
41071	7" x 10"	AL



84697	7" x 10"	SS
84698	10" x 14"	SS
22509	7" x 10"	PL
22510	10" x 14"	PL
41073	7" x 10"	AL
41074	10" x 14"	AL



47075	7" x 10"	FB
47113	10" x 14"	FB
84699	7" x 10"	SS
84700	10" x 14"	SS
22511	7" x 10"	PL
22512	10" x 14"	PL
41075	7" x 10"	AL
41076	10" x 14"	AL



84702	7" x 10"	SS
84703	10" x 14"	SS



71106	10" x 14"	FB
84704	7" x 10"	SS
84705	10" x 14"	SS
22513	7" x 10"	PL
22514	10" x 14"	PL
41077	7" x 10"	AL
41078	10" x 14"	AL



122844	7" x 10"	FB
70466	10" x 14"	FB
87775	3-1/2" x 5"	SS
84706	7" x 10"	SS
84707	10" x 14"	SS
22515	7" x 10"	PL
22516	10" x 14"	PL
41079	7" x 10"	AL
41080	10" x 14"	AL



70532	10" x 14"	FB
84710	7" x 10"	SS
84711	10" x 14"	SS
22519	7" x 10"	PL
22520	10" x 14"	PL
41084	10" x 14"	AL



70542	7" x 10"	FB
84712	7" x 10"	SS
84713	10" x 14"	SS
22521	7" x 10"	PL
22522	10" x 14"	PL
41085	7" x 10"	AL
41086	10" x 14"	AL



84714	7" x 10"	SS
84715	10" x 14"	SS
22523	7" x 10"	PL
22524	10" x 14"	PL
41087	7" x 10"	AL
41088	10" x 14"	AL



84716	7" x 10"	SS
84717	10" x 14"	SS
22525	7" x 10"	PL
22526	10" x 14"	PL
41090	10" x 14"	AL



84718	7" x 10"	SS
84719	10" x 14"	SS
22527	7" x 10"	PL
22528	10" x 14"	PL



132058	7" x 10"	FB
69091	10" x 14"	FB
87776	3-1/2" x 5"	SS
84720	7" x 10"	SS
84721	10" x 14"	SS
132059	7" x 10"	PL
22530	10" x 14"	PL
41093	7" x 10"	AL
41094	10" x 14"	AL



84725	10" x 14"	SS
22532	10" x 14"	PL
41095	7" x 10"	AL
41096	10" x 14"	AL



84726	7" x 10"	SS
84727	10" x 14"	SS
22533	7" x 10"	PL
22534	10" x 14"	PL
41097	7" x 10"	AL
41098	10" x 14"	AL



127058	7" x 10"	SS
127061	10" x 14"	SS
127057	7" x 10"	PL
127060	10" x 14"	PL
127056	7" x 10"	AL
127059	10" x 14"	AL



84730	7" x 10"	SS
22535	7" x 10"	PL
41099	7" x 10"	AL
41100	10" x 14"	AL



87774	3-1/2" x 5"	SS
-------	-------------	----



73414	7" x 17"	FB
-------	----------	----



127064	7" x 10"	SS
127067	10" x 14"	SS
127063	7" x 10"	PL
127066	10" x 14"	PL
127062	7" x 10"	AL
127065	10" x 14"	AL



70548	10" x 14"	FB
84738	7" x 10"	SS
84739	10" x 14"	SS
22543	7" x 10"	PL
22544	10" x 14"	PL
41107	7" x 10"	AL
41108	10" x 14"	AL



127076	7" x 10"	SS
127079	10" x 14"	SS
127075	7" x 10"	PL
127078	10" x 14"	PL
127074	7" x 10"	AL
127077	10" x 14"	AL



69607	10" x 14"	FB
84740	7" x 10"	SS
84741	10" x 14"	SS
22545	7" x 10"	PL
22546	10" x 14"	PL
41109	7" x 10"	AL
41110	10" x 14"	AL



## Door Signs (Continued)



127082	7" x 10"	SS
127085	10" x 14"	SS
127081	7" x 10"	PL
127084	10" x 14"	PL
127080	7" x 10"	AL
127083	10" x 14"	AL



124304	6" dia.	SS
--------	---------	----



132115	10" x 14"	FB
132114	10" x 14"	PL
132113	10" x 14"	AL



127094	7" x 10"	SS
127097	10" x 14"	SS
127093	7" x 10"	PL
127096	10" x 14"	PL
127092	7" x 10"	AL
127095	10" x 14"	AL



123817	7" x 10"	SS
123820	10" x 14"	SS
123816	7" x 10"	PL
123819	10" x 14"	PL
123815	7" x 10"	AL
123818	10" x 14"	AL

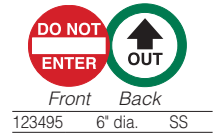

123495	6" dia.	SS
--------	---------	----

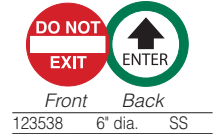

123538	6" dia.	SS
--------	---------	----



124627	3-1/2" x 10"	SS
124626	3-1/2" x 10"	PL
124625	3-1/2" x 10"	AL



132124	10" x 14"	FB
132123	10" x 14"	PL
132122	10" x 14"	AL



132130	10" x 14"	FB
132129	10" x 14"	PL
132128	10" x 14"	AL



84746	3-1/2" x 5"	SS
84747	5" x 14"	SS



84748	7" x 10"	SS
84749	10" x 14"	SS
22549	7" x 10"	PL
41113	7" x 10"	AL



84750	3-1/2" x 10"	SS
-------	--------------	----



84751	7" x 10"	SS
84752	10" x 14"	SS
25881	7" x 10"	PL
43458	7" x 10"	AL



69302	10" x 14"	FB
84755	7" x 10"	SS
84756	10" x 14"	SS
22550	7" x 10"	PL
22551	10" x 14"	PL

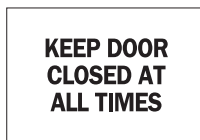

73463	10" x 14"	FB
84757	7" x 10"	SS
84758	10" x 14"	SS
22552	7" x 10"	PL
22553	10" x 14"	PL
41116	7" x 10"	AL
41117	10" x 14"	AL



132106	10" x 14"	FB
132105	10" x 14"	PL
132104	10" x 14"	AL



132118	10" x 14"	FB
132117	10" x 14"	PL
132116	10" x 14"	AL



132121	10" x 14"	FB
132120	10" x 14"	PL
132119	10" x 14"	AL



124630	3-1/2" x 10"	SS
124629	3-1/2" x 10"	PL
124628	3-1/2" x 10"	AL



132109	10" x 14"	FB
132108	10" x 14"	PL
132107	10" x 14"	AL



69415	10" x 14"	FB
84761	7" x 10"	SS
84762	10" x 14"	SS
22555	10" x 14"	PL



132112	10" x 14"	FB
132111	10" x 14"	PL
132110	10" x 14"	AL



132127	10" x 14"	FB
132126	10" x 14"	PL
132125	10" x 14"	AL



84767	3-1/2" x 10"	SS
-------	--------------	----



122904	7" x 10"	FB
122766	10" x 14"	FB
84768	7" x 10"	SS
84769	10" x 14"	SS
22558	7" x 10"	PL
22559	10" x 14"	PL
122453	7" x 10"	AL
41123	10" x 14"	AL



85747	5" x 14"	SS
-------	----------	----



75970	7" x 10"	FB
75971	10" x 14"	FB
84770	7" x 10"	SS
84771	10" x 14"	SS
22560	7" x 10"	PL
22561	10" x 14"	PL
41124	7" x 10"	AL
41125	10" x 14"	AL



# Electrical Hazard Signs

BradyID.com/s34

## Electrical Hazard Signs

Brady electrical hazard signs can be used throughout your facility to identify electrical hazard and high voltage areas. These electrical signs use bright colors, pictograms and legends to warn against entry, machine operation and buried cables.

### Popular Sign Materials

- FB** - Premium Fiberglass (B-120)
  - SS** - Self-Sticking Polyester (B-302)
  - BGSS** - BradyGlo™ Self-Sticking Polyester (B-324)
  - BGPL** - BradyGlo™ Plastic (B-347)
  - PL** - Plastic (B-401)
  - AL** - Aluminum (B-555)
- View all sign materials on page 25.*

### Can't find your sign?

Use the Sign Legend Index on page 498 or take advantage of our custom sign options.

### OSHA Regulation

#### High Voltage 1910.305(b)(iii)

Covers for boxes shall be permanently marked "High Voltage." The marking shall be on the outside of the box cover and shall be readily visible and legible.

#### Access Area Marking 1910.303(g)(1)

Sufficient access and working space must be provided and maintained about all electric equipment to permit ready and safe operation and maintenance of the equipment.

Safety Signs



122862	7" x 10"	FB
122724	10" x 14"	FB
84827	7" x 10"	SS
84828	10" x 14"	SS
122528	7" x 10"	PL
122477	10" x 14"	PL
122419	7" x 10"	AL
122353	10" x 14"	AL



71425	10" x 14"	FB
84829	7" x 10"	SS
84830	10" x 14"	SS
25502	7" x 10"	PL
25503	10" x 14"	PL
43079	7" x 10"	AL
43080	10" x 14"	AL



69292	10" x 14"	FB
84831	7" x 10"	SS
84832	10" x 14"	SS
25505	10" x 14"	PL
43081	7" x 10"	AL
43082	10" x 14"	AL



76065	10" x 14"	FB
84834	10" x 14"	SS
25506	7" x 10"	PL
43083	7" x 10"	AL
43084	10" x 14"	AL



126938	7" x 10"	SS
126941	10" x 14"	SS
126937	7" x 10"	PL
126940	10" x 14"	PL
126936	7" x 10"	AL
126939	10" x 14"	AL



126944	7" x 10"	SS
126947	10" x 14"	SS
126943	7" x 10"	PL
126946	10" x 14"	PL
126942	7" x 10"	AL
126945	10" x 14"	AL



84837	7" x 10"	SS
84838	10" x 14"	SS



126950	7" x 10"	SS
126953	10" x 14"	SS
126949	7" x 10"	PL
126952	10" x 14"	PL
126948	7" x 10"	AL
126951	10" x 14"	AL



41147	14" x 10"	AL
-------	-----------	----



126956	7" x 10"	SS
126959	10" x 14"	SS
126955	7" x 10"	PL
126958	10" x 14"	PL
126954	7" x 10"	AL
126957	10" x 14"	AL



84843	7" x 10"	SS
84844	10" x 14"	SS



69315	10" x 14"	FB
84847	7" x 10"	SS
84848	10" x 14"	SS
25512	7" x 10"	PL
25513	10" x 14"	PL
43089	7" x 10"	AL
43090	10" x 14"	AL



126962	10" x 7"	SS
126965	14" x 10"	SS
126961	10" x 7"	PL
126964	14" x 10"	PL
126960	10" x 7"	AL
126963	14" x 10"	AL



126968	7" x 10"	SS
126971	10" x 14"	SS
126967	7" x 10"	PL
126970	10" x 14"	PL
126966	7" x 10"	AL
126969	10" x 14"	AL



126974	7" x 10"	SS
126977	10" x 14"	SS
126973	7" x 10"	PL
126976	10" x 14"	PL
126972	7" x 10"	AL
126975	10" x 14"	AL



126980	10" x 7"	SS
126983	14" x 10"	SS
126979	10" x 7"	PL
126982	14" x 10"	PL
126978	10" x 7"	AL
126981	14" x 10"	AL



70533	10" x 14"	FB
84851	7" x 10"	SS
84852	10" x 14"	SS
25515	10" x 14"	PL
43092	10" x 14"	AL



70534	10" x 14"	FB
84853	7" x 10"	SS
25516	7" x 10"	PL
25517	10" x 14"	PL
43094	10" x 14"	AL



84855	7" x 10"	SS
84856	10" x 14"	SS
43095	7" x 10"	AL
43096	10" x 14"	AL



70569	10" x 14"	FB
84857	7" x 10"	SS
25520	7" x 10"	PL
25521	10" x 14"	PL
43097	7" x 10"	AL
43098	10" x 14"	AL



126986	7" x 10"	SS
126989	10" x 14"	SS
126985	7" x 10"	PL
126988	10" x 14"	PL
126984	7" x 10"	AL
126987	10" x 14"	AL



126998	7" x 10"	SS
127001	10" x 14"	SS
126997	7" x 10"	PL
127000	10" x 14"	PL
126996	7" x 10"	AL
126999	10" x 14"	AL



73404	7" x 10"	FB
84933	7" x 10"	SS
84934	10" x 14"	SS
25569	10" x 14"	PL
43145	7" x 10"	AL
43146	10" x 14"	AL



70202	7" x 10"	FB
84929	7" x 10"	SS
25566	7" x 10"	PL
25567	10" x 14"	PL
43143	7" x 10"	AL
43144	10" x 14"	AL





122864	7" x 10"	FB
122726	10" x 14"	FB
84859	7" x 10"	SS
84860	10" x 14"	SS
122530	7" x 10"	PL
122479	10" x 14"	PL
122421	7" x 10"	AL
122355	10" x 14"	AL



71432	14" x 20"	FB
-------	-----------	----



## Electrical Hazard Signs (Continued)

					
47195 10" x 14" FB 89098 7" x 10" SS 89099 10" x 14" SS 25530 7" x 10" PL 25531 10" x 14" PL 43107 7" x 10" AL 43108 10" x 14" AL	70402 20" x 14" FB 43363 10" x 7" AL 43364 14" x 10" AL	25522 7" x 10" PL 43099 7" x 10" AL	25524 7" x 10" PL 43101 7" x 10" AL 43102 10" x 14" AL	84865 7" x 10" SS 25526 7" x 10" PL 25527 10" x 14" PL 43104 10" x 14" AL	70306 7" x 17" FB 95687 10" x 14" SS 25897 10" x 14" PL 43474 10" x 14" AL
					
69192 7" x 17" FB	127004 7" x 10" SS 127007 10" x 14" SS 127003 7" x 10" PL 127006 10" x 14" PL 127002 7" x 10" AL 127005 10" x 14" AL	127016 7" x 10" SS 127019 10" x 14" SS 127015 7" x 10" PL 127018 10" x 14" PL 127014 7" x 10" AL 127017 10" x 14" AL	127010 7" x 10" SS 127013 10" x 14" SS 127009 7" x 10" PL 127012 10" x 14" PL 127008 7" x 10" AL 127011 10" x 14" AL	127022 7" x 10" SS 127025 10" x 14" SS 127021 7" x 10" PL 127024 10" x 14" PL 127020 7" x 10" AL 127023 10" x 14" AL	126992 7" x 10" SS 126995 10" x 14" SS 126991 7" x 10" PL 126994 10" x 14" PL 126990 7" x 10" AL 126993 10" x 14" AL
					
89173 2-1/4" x 4-1/2" SS 84875 3-1/2" x 5" SS	47146 10" x 7" FB 122788 14" x 10" FB 84878 10" x 7" SS 84879 14" x 10" SS 25534 10" x 7" PL 122503 14" x 10" PL 43111 10" x 7" AL 43112 14" x 10" AL	71565 7" x 10" FB 47005 10" x 14" FB 75590 14" x 20" FB 71570 20" x 28" FB 84876 7" x 10" SS 84877 10" x 14" SS 25532 7" x 10" PL 25533 10" x 14" PL 43109 7" x 10" AL 43110 10" x 14" AL	73540 7" x 10" BGSS 80204 10" x 14" BGSS 80269 7" x 10" BGPL 80270 10" x 14" BGPL	87681 14" x 10" FB 59382 10" x 7" SS 19527 14" x 10" SS 59383 10" x 7" PL 45427 14" x 10" PL 59384 10" x 7" AL 45428 14" x 10" AL	131703 7" x 10" FB 131704 10" x 14" FB 131706 3" x 3" SS 131705 3" x 5" SS 131701 7" x 10" SS 131702 10" x 14" SS 131699 7" x 10" PL 131700 10" x 14" PL 131697 7" x 10" AL 131698 10" x 14" AL
					
69023 14" x 20" FB 84883 10" x 14" SS 25538 7" x 10" PL 25539 10" x 14" PL 43115 7" x 10" AL 43116 10" x 14" AL	123697 7" x 10" SS 123700 10" x 14" SS 123696 7" x 10" PL 123699 10" x 14" PL 123695 7" x 10" AL 123698 10" x 14" AL	84884 7" x 10" SS 84885 10" x 14" SS	70388 7" x 17" FB	87678 7" x 10" FB 59385 7" x 10" SS 19837 10" x 14" SS 59386 7" x 10" PL 19839 10" x 14" PL 59387 7" x 10" AL	76072 10" x 14" FB 84880 7" x 10" SS 25537 10" x 14" PL 43113 7" x 10" AL 43114 10" x 14" AL
					
69026 10" x 14" FB 84886 7" x 10" SS 84887 10" x 14" SS 25540 7" x 10" PL 25541 10" x 14" PL 43117 7" x 10" AL 43118 10" x 14" AL	70389 7" x 17" FB	69157 10" x 14" FB 84888 7" x 10" SS 84889 10" x 14" SS 43119 7" x 10" AL 43120 10" x 14" AL	71572 20" x 14" FB 25545 14" x 10" PL 43122 14" x 10" AL	71572 20" x 14" FB 25545 14" x 10" PL 43122 14" x 10" AL	131713 7" x 10" FB 131714 10" x 14" FB 131711 7" x 10" SS 131712 10" x 14" SS 131709 7" x 10" PL 131710 10" x 14" PL 131707 7" x 10" AL 131708 10" x 14" AL



# Electrical Hazard Signs

BradyID.com/s34

## Electrical Hazard Signs (Continued)

Safety Signs



69036	10" x 14"	FB
84897	7" x 10"	SS
25548	7" x 10"	PL
25549	10" x 14"	PL
43125	7" x 10"	AL



69035	10" x 14"	FB
25551	10" x 14"	PL
43127	7" x 10"	AL
43128	10" x 14"	AL



69025	10" x 14"	FB
84903	7" x 10"	SS
84904	10" x 14"	SS
25552	7" x 10"	PL
25553	10" x 14"	PL
43129	7" x 10"	AL
43130	10" x 14"	AL



84905	7" x 10"	SS
84906	10" x 14"	SS

### Popular Sign Materials

**FB** - Premium Fiberglass (B-120)  
**SS** - Self-Sticking Polyester (B-302)  
**BGSS** - BradyGlo™ Self-Sticking Polyester (B-324)  
**BGPL** - BradyGlo™ Plastic (B-347)  
**PL** - Plastic (B-401)  
**AL** - Aluminum (B-555)

*View all sign materials on page 25.*

**Can't find your sign?**  
*Use the Sign Legend Index on page 498 or take advantage of our custom sign options.*



87667	7" x 10"	FB
19929	7" x 10"	SS
19935	10" x 14"	SS
19931	7" x 10"	PL
19937	10" x 14"	PL
19932	7" x 10"	AL
19938	10" x 14"	AL



84917	7" x 10"	SS
84918	10" x 14"	SS
69339	10" x 14"	FB
25556	7" x 10"	PL
25557	10" x 14"	PL
43134	10" x 14"	AL



123613	7" x 10"	SS
123616	10" x 14"	SS
123612	7" x 10"	PL
123615	10" x 14"	PL
123611	7" x 10"	AL
123614	10" x 14"	AL



84924	10" x 14"	SS
25560	7" x 10"	PL



59379	7" x 10"	SS
59380	7" x 10"	PL
16953	10" x 14"	PL
59381	7" x 10"	AL
16954	10" x 14"	AL



47169	7" x 10"	FB
84925	7" x 10"	SS
84926	10" x 14"	SS
25562	7" x 10"	PL
25563	10" x 14"	PL
43139	7" x 10"	AL
43140	10" x 14"	AL



127028	7" x 10"	SS
127031	10" x 14"	SS
127027	7" x 10"	PL
127030	10" x 14"	PL
127026	7" x 10"	AL
127029	10" x 14"	AL



47170	7" x 10"	FB
84927	7" x 10"	SS
84928	10" x 14"	SS
25564	7" x 10"	PL
25565	10" x 14"	PL
43141	7" x 10"	AL
43142	10" x 14"	AL



84937	7" x 10"	SS
84938	10" x 14"	SS



127034	7" x 10"	SS
127037	10" x 14"	SS
127033	7" x 10"	PL
127036	10" x 14"	PL
127032	7" x 10"	AL
127035	10" x 14"	AL



127040	7" x 10"	SS
127043	10" x 14"	SS
127039	7" x 10"	PL
127042	10" x 14"	PL
127038	7" x 10"	AL
127041	10" x 14"	AL



69586	10" x 14"	FB
84941	7" x 10"	SS
84942	10" x 14"	SS
22562	7" x 10"	PL
22563	10" x 14"	PL
41126	7" x 10"	AL
41127	10" x 14"	AL



69587	10" x 14"	FB
84943	7" x 10"	SS
84944	10" x 14"	SS
22564	7" x 10"	PL
22565	10" x 14"	PL
41128	7" x 10"	AL
41129	10" x 14"	AL



127046	7" x 10"	SS
127049	10" x 14"	SS
127045	7" x 10"	PL
127048	10" x 14"	PL
127044	7" x 10"	AL
127047	10" x 14"	AL



69613	10" x 14"	FB
84945	7" x 10"	SS
84946	10" x 14"	SS
22566	7" x 10"	PL
22567	10" x 14"	PL
41130	7" x 10"	AL
41131	10" x 14"	AL



122861	7" x 10"	FB
122723	10" x 14"	FB
84949	3-1/2" x 10"	SS
122656	7" x 10"	SS
122579	10" x 14"	SS
122527	7" x 10"	PL
122476	10" x 14"	PL
122418	7" x 10"	AL
122352	10" x 14"	AL



71463	5" x 14"	FB
71473	10" x 14"	FB
84956	5" x 14"	SS
84957	7" x 10"	SS
84958	10" x 14"	SS
25771	7" x 10"	PL
25772	10" x 14"	PL
43349	10" x 14"	AL



71479	10" x 14"	FB
84959	7" x 10"	SS
84960	10" x 14"	SS
22569	7" x 10"	PL
22570	10" x 14"	PL
41133	7" x 10"	AL
41134	10" x 14"	AL



69190	10" x 10"	FB
131729	10" x 14"	FB
89152	3" x 3"	SS
88497	10" x 10"	SS
131730	10" x 14"	SS
25162	10" x 14"	PL
42739	10" x 14"	AL



84962	3-1/2" x 10"	SS
-------	--------------	----

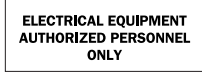

84963	3-1/2" x 10"	SS
-------	--------------	----



88498	10" x 10"	SS
42740	10" x 14"	AL



89100	3-1/2" x 10"	SS
84966	5" x 14"	SS
41136	10" x 14"	AL



69796	7" x 7"	FB
88512	7" x 7"	SS
25176	7" x 10"	PL
42753	7" x 10"	AL



71065	14" x 20"	FB
84967	7" x 10"	SS
84968	10" x 14"	SS
41137	7" x 10"	AL

## Exit and Directional Signs

Brady exit signs lead employees to safety in an emergency or guide traffic in your facility and are offered with nearly 150 different stock legends. Brady's exit signs are available in standard and photoluminescent materials, with combination lighting and emergency floodlights, as well as exit markings with safety and egress instructions.



40648 10" x 14" AL



127052 7" x 10" SS  
127055 10" x 14" SS  
127051 7" x 10" PL  
127054 10" x 14" PL  
127050 7" x 10" AL  
127053 10" x 14" AL



73482 7" x 10" FB  
71166 10" x 14" FB  
84617 7" x 10" SS  
84618 10" x 14" SS  
25761 7" x 10" PL  
25762 10" x 14" PL  
43338 7" x 10" AL  
43339 10" x 14" AL



127106 7" x 10" SS  
127109 10" x 14" SS  
127105 7" x 10" PL  
127108 10" x 14" PL  
127104 7" x 10" AL  
127107 10" x 14" AL



84622 3-1/2" x 14" SS



90491 2-1/2" x 7" BGSS  
80201 3-1/2" x 10" BGSS  
80202 5" x 14" BGSS  
80267 3-1/2" x 10" BGPL  
80268 5" x 14" BGPL



84621 1-3/4" x 10" SS

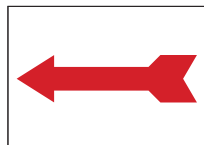

25765 7" x 10" PL  
43342 7" x 10" AL



90123 7" x 10" BGSS

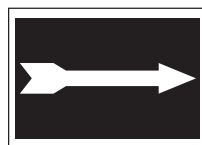

84619 3-1/2" x 10" SS  
25763 7" x 10" PL  
43340 7" x 10" AL



25766 7" x 10" PL  
43343 7" x 10" AL



25764 7" x 10" PL  
43341 7" x 10" AL



90964 7" x 10" BGPL



59279 6" x 6" BGSS



127088 7" x 10" SS  
127091 10" x 14" SS  
127087 7" x 10" PL  
127090 10" x 14" PL  
127086 7" x 10" AL  
127089 10" x 14" AL



80272 5" x 14" BGPL



90926 5" x 14" BGPL



132200 7" x 10" FB  
132201 10" x 14" FB  
123811 7" x 10" SS  
123814 10" x 14" SS  
123810 7" x 10" PL  
123813 10" x 14" PL  
123809 7" x 10" AL  
123812 10" x 14" AL



### OSHA Regulation

#### Not an Exit 1910.37(b)(5)

Any door, passage, or stairway that is not an exit or a way to get to an exit, but looks as though it could be an exit must be marked with a sign reading "NOT AN EXIT," or must be identified by a sign telling what it is, such as "to basement," "storeroom," "linen closet," or whatever it may be.

#### Evacuation Route 1910.38(a)(2), 1910.120(1)(2)(vi) (Informational marking)

Elements of an emergency response plan. The employer shall develop an emergency response plan for emergencies which shall address, as minimum, the following:...(vi) Evacuation routes and procedures.

#### Exit 1910.37(b)(4)

If the direction of travel to the exit or exit discharge is not immediately apparent, signs must be posted along the exit access indicating the direction of travel to the nearest exit and exit discharge. Additionally, the line-of-sight to an exit sign must clearly be visible at all times.

#### EXIT 29 CFR 1910.37 (b)(7)

Each exit sign must have the word "Exit" in plainly legible letters not less than 6" (15.2 cm) high, with the principal strokes of the letters in the word "Exit" not less than 3/4" (1.9 cm) wide.

# Exit and Directional Signs

BradyID.com/s34

## Exit and Directional Signs (Continued)

Safety Signs



132172	7" x 10"	FB
132173	10" x 14"	FB
132174	7" x 10"	SS
132175	10" x 14"	SS
132168	7" x 10"	PL
132169	10" x 14"	PL
132170	7" x 10"	AL
132171	10" x 14"	AL



132156	7" x 10"	FB
132157	10" x 14"	FB
132158	7" x 10"	SS
132159	10" x 14"	SS
132152	7" x 10"	PL
132153	10" x 14"	PL
132154	7" x 10"	AL
132155	10" x 14"	AL



132164	7" x 10"	FB
132165	10" x 14"	FB
132166	7" x 10"	SS
132167	10" x 14"	SS
132160	7" x 10"	PL
132161	10" x 14"	PL
132162	7" x 10"	AL
132163	10" x 14"	AL



90109	7" x 10"	BGSS
90623	10" x 14"	BGSS
90951	7" x 10"	BGPL
90635	10" x 14"	BGPL

### Popular Sign Materials

**FB** - Premium Fiberglass (B-120)  
**SS** - Self-Sticking Polyester (B-302)  
**BGSS** - BradyGlo™ Self-Sticking Polyester (B-324)  
**BGPL** - BradyGlo™ Plastic (B-347)  
**PL** - Plastic (B-401)  
**AL** - Aluminum (B-555)

*View all sign materials on page 25.*

---

**Can't find your sign?**  
*Use the Sign Legend Index on page 498 or take advantage of our custom sign options.*



90622	10" x 14"	BGSS
90950	7" x 10"	BGPL
90634	10" x 14"	BGPL



80207	3-1/2" x 10"	BGSS
80208	5" x 14"	BGSS
80273	3-1/2" x 10"	BGPL
80274	5" x 14"	BGPL



90494	10" x 14"	BGSS
90495	10" x 14"	BGPL



69199	10" x 14"	FB
84663	7" x 10"	SS
84664	10" x 14"	SS
22481	7" x 10"	PL
22482	10" x 14"	PL
41045	7" x 10"	AL
41046	10" x 14"	AL



132131	7" x 10"	FB
--------	----------	----



70915	5" x 14"	FB
122793	7" x 10"	FB
122705	10" x 14"	FB
84662	5" x 14"	SS
122635	7" x 10"	SS
122565	10" x 14"	SS
22480	7" x 10"	PL
122464	10" x 14"	PL
41044	7" x 10"	AL
122338	10" x 14"	AL



90102	7" x 10"	BGSS
90616	10" x 14"	BGSS
90944	7" x 10"	BGPL
90628	10" x 14"	BGPL



123787	7" x 10"	SS
123790	10" x 14"	SS
123786	7" x 10"	PL
123789	10" x 14"	PL
123785	7" x 10"	AL
123788	10" x 14"	AL



75978	7" x 10"	FB
122757	10" x 14"	FB
89156	3-1/2" x 10"	SS
84665	7" x 10"	SS
84666	10" x 14"	SS
22483	7" x 10"	PL
22484	10" x 14"	PL
41047	7" x 10"	AL
41048	10" x 14"	AL



90924	5" x 14"	BGPL
-------	----------	------



90923	5" x 14"	BGPL
-------	----------	------



80211	3-1/2" x 10"	BGSS
80212	5" x 14"	BGSS
80277	3-1/2" x 10"	BGPL
80278	5" x 14"	BGPL

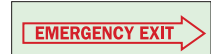

80209	3-1/2" x 10"	BGSS
80210	5" x 14"	BGSS
80275	3-1/2" x 10"	BGPL
80276	5" x 14"	BGPL



84661	6-1/2" x 14"	SS
22479	10" x 14"	PL
41043	10" x 14"	AL



90933	5" x 14"	BGPL
-------	----------	------



80213	7" x 10"	BGSS
80214	10" x 14"	BGSS
80279	7" x 10"	BGPL
80280	10" x 14"	BGPL

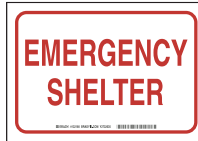

132180	7" x 10"	FB
132181	10" x 14"	FB
132182	7" x 10"	SS
132183	10" x 14"	SS
132176	7" x 10"	PL
132177	10" x 14"	PL
132178	7" x 10"	AL
132179	10" x 14"	AL



123805	7" x 10"	SS
123808	10" x 14"	SS
123804	7" x 10"	PL
123807	10" x 14"	PL
123803	7" x 10"	AL
123806	10" x 14"	AL



90934	5" x 14"	BGPL
-------	----------	------



90940	5" x 14"	BGPL
-------	----------	------



90927	5" x 14"	BGPL
-------	----------	------



84667	7" x 10"	SS
22485	7" x 10"	PL
41049	7" x 10"	AL



70923	14" x 20"	FB
84668	7" x 10"	SS
84669	10" x 14"	SS
22486	7" x 10"	PL
41050	7" x 10"	AL



84626	10" x 14"	SS
25768	10" x 14"	PL
43345	10" x 14"	AL

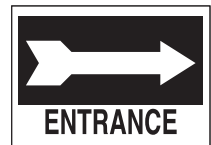

84625	6-1/2" x 14"	SS
25767	10" x 14"	PL
43344	10" x 14"	AL

## Exit and Directional Signs (Continued)



90941 5' x 14' BGPL



70323 6-1/2' x 14' FB  
84670 5' x 14' SS  
22487 7' x 10' PL  
41051 7' x 10' AL



Meets OSHA 1910.37(b)(7):  
73509 7' x 10' BGSS  
73510 10' x 14' BGSS  
80281 7' x 10' BGPL  
80282 10' x 14' BGPL



73558 4' x 9' BGSS



Meets OSHA 1910.37(b)(7):  
84675 7' x 10' SS  
84676 10' x 14' SS  
22491 7' x 10' PL  
22492 10' x 14' PL  
41055 7' x 10' AL



Meets OSHA 1910.37(b)(7):  
47040 7' x 10' FB  
47288 10' x 14' FB  
84673 7' x 10' SS  
84674 10' x 14' SS  
22489 7' x 10' PL  
22490 10' x 14' PL  
41053 7' x 10' AL  
41054 10' x 14' AL



80215 7' x 10' BGSS  
80283 7' x 10' BGPL  
Meets OSHA 1910.37(b)(7):  
73513 10' x 14' BGSS  
80284 10' x 14' BGPL



95142 7' x 10' B-997



84677 7' x 10' SS  
22493 7' x 10' PL  
Meets OSHA 1910.37(b)(7):  
84678 10' x 14' SS



59329 3' x 6' BGSS  
59330 3' x 6' BGPL



70947 7' x 10' FB  
84671 7' x 10' SS  
22488 7' x 10' PL  
41052 7' x 10' AL  
Meets OSHA 1910.37(b)(7):  
70949 10' x 14' FB  
84672 10' x 14' SS  
51552 10' x 14' PL



51551 10' x 14' SS  
Package includes 6 identical signs.



70976 14' x 20' FB  
84679 7' x 10' SS  
84680 10' x 14' SS  
22494 7' x 10' PL  
41058 7' x 10' AL



Meets OSHA 1910.37(b)(7):  
80221 10' x 7' BGSS  
80222 14' x 10' BGSS  
80289 10' x 7' BGPL  
80290 14' x 10' BGPL



84633 7' x 10' SS  
22459 7' x 10' PL  
41023 7' x 10' AL  
Meets OSHA 1910.37(b)(7):  
84634 10' x 14' SS  
22460 10' x 14' PL  
41024 10' x 14' AL



Meets OSHA 1910.37(b)(7):  
80219 10' x 7' BGSS  
80220 14' x 10' BGSS  
80287 10' x 7' BGPL  
80288 14' x 10' BGPL



Meets OSHA 1910.37(b)(7):  
80217 10' x 7' BGSS  
80218 14' x 10' BGSS  
80285 10' x 7' BGPL  
80286 14' x 10' BGPL



51640 12' x 9' Glow Self Adhesive

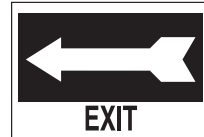

70325 6-1/2' x 14' FB  
84628 6-1/2' x 14' SS  
22454 10' x 14' PL  
41018 10' x 14' AL

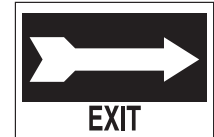

84627 6-1/2' x 14' SS  
22453 10' x 14' PL  
41017 10' x 14' AL



47035 7' x 14' FB  
76066 10' x 14' FB  
122636 7' x 10' SS  
84632 10' x 14' SS  
22457 7' x 10' PL  
22458 10' x 14' PL  
41021 7' x 10' AL  
41022 10' x 14' AL



47034 7' x 14' FB  
76067 10' x 14' FB  
122634 7' x 10' SS  
84630 10' x 14' SS  
22455 7' x 10' PL  
22456 10' x 14' PL  
41019 7' x 10' AL  
41020 10' x 14' AL

### May we also suggest:

#### Perimeter L.E.D. Exit Signs

- An economical alternative to traditional, incandescent or fluorescent exit signs.
- Listed to UL 924 and in compliance with OSHA, NEC® and NFP standard
- Include a 90-minute nickel cadmium battery back-up assembly for power failure
- Standard input voltages are 120 or 277AC



Catalog #	Description	Color	Size
56905	Perimeter LED Exit Sign	Black/Red	7-1/2" x 12-1/4" x 2-1/2"
56907	Perimeter LED Exit Sign	White/Red	7-1/2" x 12-1/4" x 2-1/2"
56908	Perimeter LED Exit Sign	White/Green	7-1/2" x 12-1/4" x 2-1/2"



# Exit and Directional Signs

BradyID.com/s34

## Exit and Directional Signs (Continued)



90966 7" x 10" BGPL



84685 7" x 10" SS  
84686 10" x 14" SS  
22499 7" x 10" PL  
22500 10" x 14" PL  
41063 7" x 10" AL  
41064 10" x 14" AL



73542 7" x 10" BGSS  
80247 10" x 14" BGSS  
85480 7" x 10" BGPL  
85481 10" x 14" BGPL

**Popular Sign Materials**

**FB** - Premium Fiberglass (B-120)  
**SS** - Self-Sticking Polyester (B-302)  
**BGSS** - BradyGlo™ Self-Sticking Polyester (B-324)  
**BGPL** - BradyGlo™ Plastic (B-347)  
**PL** - Plastic (B-401)  
**AL** - Aluminum (B-555)

*View all sign materials on page 25.*

**Can't find your sign?**  
*Use the Sign Legend Index on page 498 or take advantage of our custom sign options.*



90105 7" x 10" BGSS  
90619 10" x 14" BGSS  
90947 7" x 10" BGPL  
90631 10" x 14" BGPL



90492 3-1/2" x 10" BGSS



73545 7" x 10" BGSS  
80250 10" x 14" BGSS  
85484 7" x 10" BGPL  
85523 10" x 14" BGPL



71015 7" x 10" FB  
71016 10" x 14" FB  
84687 7" x 10" SS  
84688 10" x 14" SS  
22501 7" x 10" PL  
22502 10" x 14" PL  
41065 7" x 10" AL  
41066 10" x 14" AL



70460 6-1/2" x 14" FB  
84642 6-1/2" x 14" SS  
22466 10" x 14" PL  
41030 10" x 14" AL



73417 6-1/2" x 14" FB  
84641 6-1/2" x 14" SS  
22465 10" x 14" PL  
41029 10" x 14" AL



84644 6-1/2" x 14" SS  
22468 10" x 14" PL  
41032 10" x 14" AL

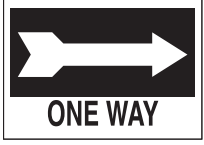

73467 6-1/2" x 14" FB  
84643 6-1/2" x 14" SS  
22467 10" x 14" PL  
41031 10" x 14" AL



80253 2-1/2" x 7" BGSS  
85528 2-1/2" x 7" BGPL



90929 5" x 14" BGPL



80254 2-1/2" x 7" BGSS  
85540 2-1/2" x 7" BGPL



90611 5" x 14" BGSS  
90939 5" x 14" BGPL



90928 5" x 14" BGPL



84648 6-1/2" x 14" SS  
22470 10" x 14" PL  
41034 10" x 14" AL

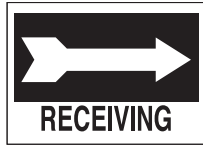

84647 6-1/2" x 14" SS  
22469 10" x 14" PL  
41033 10" x 14" AL



132188 7" x 10" FB  
132189 10" x 14" FB  
132190 7" x 10" SS  
132191 10" x 14" SS  
132184 7" x 10" PL  
132185 10" x 14" PL  
132186 7" x 10" AL  
132187 10" x 14" AL



123799 10" x 7" SS  
123802 14" x 10" SS  
123798 10" x 7" PL  
123801 14" x 10" PL  
123797 10" x 7" AL  
123800 14" x 10" AL  
132186 7" x 10" AL  
132187 10" x 14" AL



123793 10" x 7" SS  
123796 14" x 10" SS  
123792 10" x 7" PL  
123795 14" x 10" PL  
123791 10" x 7" AL  
123794 14" x 10" AL



90550 10" x 7" BGSS  
90183 14" x 10" BGSS  
90714 10" x 7" BGPL  
90776 14" x 10" BGPL



73473 6-1/2" x 14" FB  
22472 10" x 14" PL  
41036 10" x 14" AL



70525 6-1/2" x 14" FB  
22471 10" x 14" PL  
41035 10" x 14" AL



90936 5" x 14" BGPL



80255 10" x 14" BGSS  
85541 7" x 10" BGPL  
85545 10" x 14" BGPL





















80261 10" x 14" BGSS  
80027 7" x 10" BGPL  
80028 10" x 14" BGPL

Safety Signs

# Exit and Directional Signs

BradyID.com/s34

## Exit and Directional Signs (Continued)

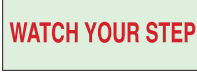
					
90931 5' x 14" BGPL	80259 10' x 14" BGSS 85601 7' x 10" BGPL	80256 7' x 10" BGSS 80257 10' x 14" BGSS 85546 7' x 10" BGPL	127100 7' x 10" SS 127103 10' x 14" SS 127099 7' x 10" PL 127102 10' x 14" PL 127098 7' x 10" AL 127101 10' x 14" AL	90713 7' x 10" BGPL 90775 10' x 14" BGPL	84689 7' x 10" SS 84690 10' x 14" SS 22503 7' x 10" PL 22504 10' x 14" PL 41067 7' x 10" AL 41068 10' x 14" AL
					
71373 6-1/2' x 14" FB 84654 6-1/2' x 14" SS 22476 10' x 14" PL	71366 6-1/2' x 14" FB 84653 6-1/2' x 14" SS 22475 10' x 14" PL	80264 3-1/2' x 10" BGSS 80040 3-1/2' x 10" BGPL 80041 5' x 14" BGPL	80262 3-1/2' x 10" BGSS 80029 3-1/2' x 10" BGPL 80035 5' x 14" BGPL	84652 6-1/2' x 14" SS 41038 10' x 14" AL	70550 6-1/2' x 14" FB 84651 6-1/2' x 14" SS 22473 10' x 14" PL 41037 10' x 14" AL
					
		90553 7' x 10" BGSS 90186 10' x 14" BGSS 90717 7' x 10" BGPL	90185 10' x 14" BGSS	87651 7' x 10" FB 59388 7' x 10" SS 59389 7' x 10" PL	
					
		59391 7' x 10" SS	90551 10' x 7" BGSS 90184 14' x 10" BGSS 90777 14' x 10" BGPL	80266 2-1/2' x 7" BGSS 80048 2-1/2' x 7" BGPL	

Safety Signs

**Custom Signs**

Brady's custom sign options make it easy to create signs unique to your emergency egress routes.

**View page 194 for more information.**



# Exit and Directional Signs

BradyID.com/s34

## BradyGlo™ Exit Signs

### IBC/IFC Compliant BradyGlo™ Directional Exit Signs

















- Doors opening to corridors where such corridors act as required exit passageways connecting two vertical exits
- Doors serving as horizontal exits or stairwell exits
- Transfer levels and wherever egress direction is not clear

#### Sign Materials

**BGSS** - BradyGlo™ Self-Sticking Polyester (B-984)  
**BGPL** - BradyGlo™ Polystyrene (B-985)  
**BGAL** - BradyGlo™ Aluminum (B-986)  
 View all sign materials on page 25.

#### Can't find your sign?

Use the Sign Legend Index on page 498 or take advantage of our custom sign options.

					
114685 7" x 15" BGSS 114686 7" x 15" BGPL 114687 7" x 15" BGAL	114691 7" x 15" BGSS 114692 7" x 15" BGPL 114693 7" x 15" BGAL	114688 7" x 15" BGSS 114689 7" x 15" BGPL 114690 7" x 15" BGAL	114673 7" x 15" BGSS 114674 7" x 15" BGPL 114675 7" x 15" BGAL	114679 7" x 15" BGSS 114680 7" x 15" BGPL 114681 7" x 15" BGAL	114676 7" x 15" BGSS 114677 7" x 15" BGPL 114678 7" x 15" BGAL
					
114660 7" x 21" BGAL 114658 7" x 21" BGSS 114659 7" x 21" BGPL	114664 7" x 21" BGSS 114665 7" x 21" BGPL 114666 7" x 21" BGAL	114661 7" x 21" BGSS 114662 7" x 21" BGPL 114663 7" x 21" BGAL	114649 7" x 21" BGSS 114650 7" x 21" BGPL 114651 7" x 21" BGAL	114655 7" x 21" BGSS 114656 7" x 21" BGPL 114657 7" x 21" BGAL	114652 7" x 21" BGSS 114653 7" x 21" BGPL 114654 7" x 21" BGAL
					
114646 10" x 22" BGSS 114647 10" x 22" BGPL 114648 10" x 22" BGAL	114643 10" x 22" BGSS 114644 10" x 22" BGPL 114645 10" x 22" BGAL	114637 14" x 10" BGSS 114638 14" x 10" BGPL 114639 14" x 10" BGAL	114640 14" x 10" BGSS 114641 14" x 10" BGPL 114642 14" x 10" BGAL		



### IBC/IFC Compliant BradyGlo™ Door Handle Markers



Plastic Push Bar Door Marker

Catalog #	Description	Legend	Size
114912	Plastic Push Bar Door Marker	Push	2" x 30"
114913	Plastic Push Bar Door Marker	Blank	2" x 30"
114914	Plastic Push Bar Door Marker	Push	1.5" x 18"
114915	Plastic Push Bar Door Marker	Blank	1.5" x 18"
114697	BGSS Self-Sticking Adhesive		4.125" x 4.125"

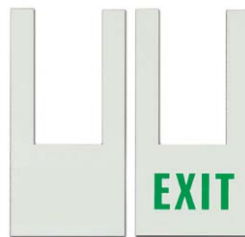

Vertical Plastic Door Handle Markers

Catalog #	Description	Legend	Size
114917	Plastic Door Handle Marker - Vertical	Exit	7" x 10"
114918	Plastic Door Handle Marker - Vertical	Blank	7" x 10"

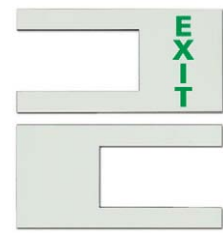

Horizontal Plastic Door Handle Markers

Catalog #	Description	Legend	Size
114919	Plastic Door Handle Marker - Horizontal	Exit	7" x 10"
114921	Plastic Door Handle Marker - Horizontal	Blank	7" x 10"



## BradyGlo™ Exit Signs

### IBC/IFC, NYC Compliant BradyGlo™ High Performance Photoluminescent Exit Sign

- Compliant to NFPA Life Safety Code 101 and and 2015 IBC Regulation and current building codes
- Energy efficient, non-electric, non-toxic, non-radioactive and may qualify for LEED credits
- 50ft visibility, 100% reliable and virtually maintenance free
- 3 configurations which can be attached on a surface, ceiling or flag mounted



BradyGlo™ Kick Plate Exit Sign

Catalog #	Description	Size
<b>B-355 Kick Plate Sign</b>		
113063B	Kick Plate Exit Sign	10" x 34"



Frameless BradyGlo™ Exit Signs

Catalog #	Description	Size
<b>B-374 Frameless Sign</b>		
87807B	Frameless Red Exit Sign	8-1/2" x 15"
87808B	Frameless Green Exit Sign	8-1/2" x 15"



Framed Wall Mount Exit Sign

Mounting Brackets

Catalog #	Description	Size
<b>B-355 Framed Single Face Wall Mount Sign</b>		
37851B	Single Face Wall Mount	8-1/4" x 15-1/4" Black
90885B	Single Face Wall Mount	8-1/4" x 15-1/4" Red
90887B	Single Face Wall Mount	8-1/4" x 15-1/4" Green
80753B	Single Face Wall Mount	8-1/4" x 15-1/4" White
112653B	Single Face Wall Mount	8-1/4" x 15-1/4" Silver
<b>B-355 Framed Single Face Sign w/ Bracket</b>		
38097B	Single Face w/ Bracket	8-1/4" x 15-1/4" Black
90839B	Single Face w/ Bracket	8-1/4" x 15-1/4" Red
90841B	Single Face w/ Bracket	8-1/4" x 15-1/4" Green
80754B	Single Face w/ Bracket	8-1/4" x 15-1/4" White
112654B	Single Face w/ Bracket	8-1/4" x 15-1/4" Silver
<b>B-355 Framed Double Face Sign w/ Bracket</b>		
38098B	Double Face w/ Bracket	8-1/4" x 15-1/4" Black
90840B	Double Face w/ Bracket	8-1/4" x 15-1/4" Red
90842B	Double Face w/ Bracket	8-1/4" x 15-1/4" Green
80755B	Double Face w/ Bracket	8-1/4" x 15-1/4" White
112655B	Double Face w/ Bracket	8-1/4" x 15-1/4" Silver
<b>B-355 Extra Mounting Bracket</b>		
38099B	Mounting Bracket	Black
90886B	Mounting Bracket	Red
90888B	Mounting Bracket	Green
80756B	Mounting Bracket	White
112656B	Mounting Bracket	Silver

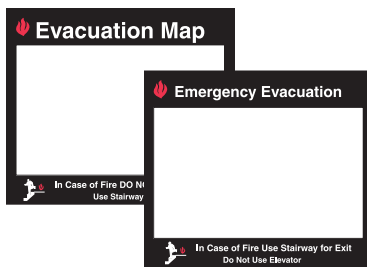

### Evacuation Frames

- Holders display your custom evacuation maps
- Clear acrylic frames hold your custom maps and allow you to easily change them when updates are needed

Catalog #	Description	Size	Material
102857	Emergency Evacuation Frame	17-1/2" X 15"	Luminous
102852	Evacuation Map Frame	17-1/2" X 15"	Standard
102851	Evacuation Map Frame	11-1/2" X 11"	Luminous
102853	Evacuation Map Frame	17-1/2" X 15"	Luminous



### Evacuation Map Display Holder

- Easy-to-see acrylic board
- Quickly shows viewers the best evacuation route from their work area

Catalog #	Description	Size
45381	Evacuation Map Display Holder	15" x 11"

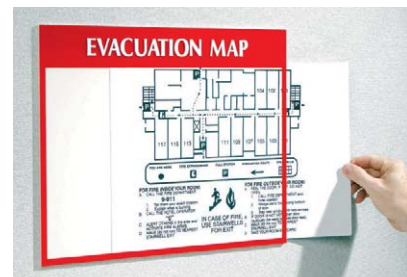

### Evacuation Plan Insert Holder

- Simply print and insert your evacuation map
- Accommodates standard 17" x 11" insert Non-glare, scratch-resistant finish
- Vivid red border with raised white lettering
- 2 adhesive mounting strips on back for easy installation

Catalog #	Description	Size
102849	Evacuation Plan Insert Holder	17-1/2" x 13-1/2"



# Evacuation Assembly / Muster Point Signs

BradyID.com/s34

## Evacuation Assembly / Muster Point Signs

During an emergency, it is imperative for employees and visitors to know where to congregate safely. Make sure these designated areas are clearly marked in order to communicate to everyone in your facility.

Brady's Muster Point, Assembly Point, and Evacuation Point signs are designed with ISO approved pictogram for assembly points, and help keep your facility up to code.

### Popular Sign Materials

- FB** - Premium Fiberglass (B-120)
  - SS** - Self-Sticking Polyester (B-302)
  - BGSS** - BradyGlo™ Self-Sticking Polyester (B-324)
  - BGPL** - BradyGlo™ Plastic (B-347)
  - PL** - Plastic (B-401)
  - AL** - Aluminum (B-555)
- View all sign materials on page 25.*

**Can't find your sign?**  
Use the Sign Legend Index on page 498 or take advantage of our custom sign options.

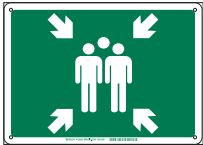

139559	10" x 14"	FB
139560	14" x 20"	FB
139561	18" x 24"	FB
139562	10" x 14"	PL
139563	14" x 20"	PL
139564	18" x 24"	PL
139565	10" x 14"	AL
139566	14" x 20"	AL
139567	18" x 24"	AL



139622	10" x 14"	FB
139623	14" x 20"	FB
139624	18" x 24"	FB
139625	10" x 14"	PL
139626	14" x 20"	PL
139627	18" x 24"	PL
139628	10" x 14"	AL
139629	14" x 20"	AL
139630	18" x 24"	AL



139577	10" x 14"	FB
139578	14" x 20"	FB
139579	18" x 24"	FB
139580	10" x 14"	PL
139581	14" x 20"	PL
139582	18" x 24"	PL
139583	10" x 14"	AL
139584	14" x 20"	AL
139585	18" x 24"	AL



139640	10" x 14"	FB
139641	14" x 20"	FB
139642	18" x 24"	FB
139643	10" x 14"	PL
139644	14" x 20"	PL
139645	18" x 24"	PL
139646	10" x 14"	AL
139647	14" x 20"	AL
139648	18" x 24"	AL



139595	10" x 14"	FB
139596	14" x 20"	FB
139597	18" x 24"	FB
139598	10" x 14"	PL
139599	14" x 20"	PL
139600	18" x 24"	PL
139601	10" x 14"	AL
139602	14" x 20"	AL
139603	18" x 24"	AL



139649	10" x 14"	FB
139650	14" x 20"	FB
139651	18" x 24"	FB
139652	10" x 14"	PL
139653	14" x 20"	PL
139654	18" x 24"	PL
139655	10" x 14"	AL
139656	14" x 20"	AL
139657	18" x 24"	AL



139604	10" x 14"	FB
139605	14" x 20"	FB
139606	18" x 24"	FB
139607	10" x 14"	PL
139608	14" x 20"	PL
139609	18" x 24"	PL
139610	10" x 14"	AL
139611	14" x 20"	AL
139612	18" x 24"	AL



139631	10" x 14"	FB
139632	14" x 20"	FB
139633	18" x 24"	FB
139634	10" x 14"	PL
139635	14" x 20"	PL
139636	18" x 24"	PL
139637	10" x 14"	AL
139638	14" x 20"	AL
139639	18" x 24"	AL



139586	10" x 14"	FB
139587	14" x 20"	FB
139588	18" x 24"	FB
139589	10" x 14"	PL
139590	14" x 20"	PL
139591	18" x 24"	PL
139592	10" x 14"	AL
139593	14" x 20"	AL
139594	18" x 24"	AL



139613	10" x 14"	FB
139614	14" x 20"	FB
139615	18" x 24"	FB
139616	10" x 14"	PL
139617	14" x 20"	PL
139618	18" x 24"	PL
139619	10" x 14"	AL
139620	14" x 20"	AL
139621	18" x 24"	AL



139568	10" x 14"	FB
139569	14" x 20"	FB
139570	18" x 24"	FB
139571	10" x 14"	PL
139572	14" x 20"	PL
139573	18" x 24"	PL
139574	10" x 14"	AL
139575	14" x 20"	AL
139576	18" x 24"	AL



139658	10" x 14"	FB
139659	14" x 20"	FB
139660	18" x 24"	FB
139661	10" x 14"	PL
139662	14" x 20"	PL
139663	18" x 24"	PL
139664	10" x 14"	AL
139665	14" x 20"	AL
139666	18" x 24"	AL



139667	10" x 14"	FB
139668	14" x 20"	FB
139669	18" x 24"	FB
139670	10" x 14"	PL
139671	14" x 20"	PL
139672	18" x 24"	PL
139673	10" x 14"	AL
139674	14" x 20"	AL
139675	18" x 24"	AL



139676	10" x 14"	FB
139677	14" x 20"	FB
139678	18" x 24"	FB
139679	10" x 14"	PL
139680	14" x 20"	PL
139681	18" x 24"	PL
139682	10" x 14"	AL
139683	14" x 20"	AL
139684	18" x 24"	AL



139685	10" x 14"	FB
139686	14" x 20"	FB
139687	18" x 24"	FB
139688	10" x 14"	PL
139689	14" x 20"	PL
139690	18" x 24"	PL
139691	10" x 14"	AL
139692	14" x 20"	AL
139693	18" x 24"	AL



139694	10" x 14"	FB
139695	14" x 20"	FB
139696	18" x 24"	FB
139697	10" x 14"	PL
139698	14" x 20"	PL
139699	18" x 24"	PL
139700	10" x 14"	AL
139703	14" x 20"	AL
139704	18" x 24"	AL

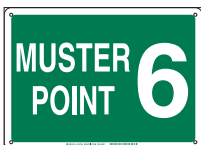

139705	10" x 14"	FB
139706	14" x 20"	FB
139707	18" x 24"	FB
139708	10" x 14"	PL
139709	14" x 20"	PL
139710	18" x 24"	PL
139711	10" x 14"	AL
139712	14" x 20"	AL
139713	18" x 24"	AL

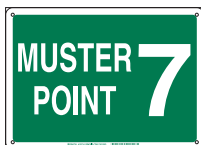

139714	10" x 14"	FB
139715	14" x 20"	FB
139716	18" x 24"	FB
139717	10" x 14"	PL
139718	14" x 20"	PL
139719	18" x 24"	PL
139720	10" x 14"	AL
139721	14" x 20"	AL
139722	18" x 24"	AL

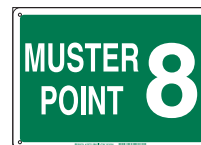

139723	10" x 14"	FB
139724	14" x 20"	FB
139725	18" x 24"	FB
139726	10" x 14"	PL
139727	14" x 20"	PL
139728	18" x 24"	PL
139729	10" x 14"	AL
139730	14" x 20"	AL
139731	18" x 24"	AL

## IMO (International Maritime Organization) Evacuation Signs

Brady IMO signs are designed to meet the needs of the marine and shipping industry. In the event of an emergency, IMO signs help warn, instruct and advise passengers of proper evacuation procedures. These IMO signs are highly visible to help facilitate a safe and efficient onboard ship evacuation and comply with the IMO (International Maritime Organization) resolution A.752 (18).

### Material Information

**BGSS** - BradyGlo™ Self-Sticking Polyester (B-324)

**BGPL** - BradyGlo™ Plastic (B-347)

View all sign materials on page 25.

### Can't find your sign?

Use the Sign Legend Index on page 498 or take advantage of our custom sign options.



59289 6" x 6" BGSS



59293 6" x 6" BGSS



59109 6" x 6" BGPL



59335 6" x 6" BGSS  
59336 6" x 6" BGPL



59283 6" x 6" BGSS



59122 6" x 6" BGSS



59111 6" x 6" BGPL



59114 6" x 6" BGSS



59112 6" x 6" BGSS



59102 6" x 6" BGSS



59341 6" x 6" BGSS  
59342 6" x 6" BGPL



59345 6" x 6" BGSS  
59346 6" x 6" BGPL



80899 6" x 6" BGSS

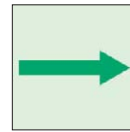

80903 6" x 6" BGSS

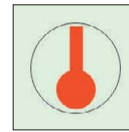

80885 6" x 6" BGSS

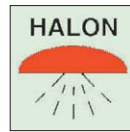

80735 6" x 6" BGSS



59277 6" x 6" BGSS



59349 6" x 6" BGSS  
59350 6" x 6" BGPL



59299 6" x 3" BGSS



59301 6" x 3" BGSS  
59302 6" x 3" BGPL



59303 6" x 3" BGSS  
59304 6" x 3" BGPL



59305 6" x 3" BGSS  
59306 6" x 3" BGPL



59307 6" x 3" BGSS  
59308 6" x 3" BGPL



59310 6" x 3" BGPL



59312 6" x 3" BGPL



59314 6" x 3" BGPL



59316 6" x 3" BGPL



59298 6" x 3" BGPL



# Fire Safety Signs

BradyID.com/s34

## Fire Safety Signs

Brady fire signs help you quickly identify fire exits, fire extinguishers and other fire suppression equipment in your facility. With exit standard red/white and glow-in-the-dark fire signs, you can clearly indicate flammable materials and mark your entire facility for emergency safety.

Safety Signs



73458	10" x 14"	FB
89104	7" x 10"	SS
89105	10" x 14"	SS
25640	7" x 10"	PL
25641	10" x 14"	PL
43217	7" x 10"	AL
43218	10" x 14"	AL



89106	7" x 10"	SS
89107	10" x 14"	SS
25642	7" x 10"	PL
25643	10" x 14"	PL
43220	10" x 14"	AL



89110	7" x 10"	SS
85148	10" x 14"	SS
25644	7" x 10"	PL
25645	10" x 14"	PL
43221	7" x 10"	AL
43222	10" x 14"	AL



70225	14" x 20"	FB
85151	7" x 10"	SS
85152	10" x 14"	SS
25646	7" x 10"	PL
25647	10" x 14"	PL
43223	7" x 10"	AL
43224	10" x 14"	AL



73440	10" x 14"	FB
86033	7" x 10"	SS
86034	10" x 14"	SS
23215	7" x 10"	PL
23216	10" x 14"	PL
41889	7" x 10"	AL
41890	10" x 14"	AL



85197	7" x 10"	SS
85198	10" x 14"	SS
25676	7" x 10"	PL
25677	10" x 14"	PL
43254	10" x 14"	AL



69511	10" x 14"	FB
85199	7" x 10"	SS
85200	10" x 14"	SS
25678	7" x 10"	PL
25679	10" x 14"	PL
43255	7" x 10"	AL
43256	10" x 14"	AL



71715	14" x 20"	FB
85294	10" x 14"	SS
22688	7" x 10"	PL
22689	10" x 14"	PL
41252	7" x 10"	AL
41253	10" x 14"	AL



122832	7" x 10"	FB
71708	10" x 14"	FB
122651	7" x 10"	SS
85206	10" x 14"	SS
25680	7" x 10"	PL
25681	10" x 14"	PL
43257	7" x 10"	AL
43258	10" x 14"	AL



127346	7" x 10"	SS
127349	10" x 14"	SS
127345	7" x 10"	PL
127348	10" x 14"	PL
127344	7" x 10"	AL
127347	10" x 14"	AL



70410	10" x 14"	FB
85639	10" x 14"	SS
22798	7" x 10"	PL
22799	10" x 14"	PL
41362	7" x 10"	AL
41363	10" x 14"	AL



85209	7" x 10"	SS
85210	10" x 14"	SS



80007	10" x 14"	SS
80017	10" x 14"	PL
80009	10" x 14"	AL



127352	7" x 10"	SS
127355	10" x 14"	SS
127351	7" x 10"	PL
127354	10" x 14"	PL
127350	7" x 10"	AL
127353	10" x 14"	AL



127358	7" x 10"	SS
127361	10" x 14"	SS
127357	7" x 10"	PL
127360	10" x 14"	PL
127356	7" x 10"	AL
127359	10" x 14"	AL



127370	7" x 10"	SS
127373	10" x 14"	SS
127369	7" x 10"	PL
127372	10" x 14"	PL
127368	7" x 10"	AL
127371	10" x 14"	AL



69582	10" x 14"	FB
85219	7" x 10"	SS
85220	10" x 14"	SS
25690	7" x 10"	PL
25691	10" x 14"	PL
43267	7" x 10"	AL
43268	10" x 14"	AL



69583	10" x 14"	FB
85221	7" x 10"	SS
85222	10" x 14"	SS
25692	7" x 10"	PL
25693	10" x 14"	PL
43269	7" x 10"	AL



127364	7" x 10"	SS
127367	10" x 14"	SS
127363	7" x 10"	PL
127366	10" x 14"	PL
127362	7" x 10"	AL
127365	10" x 14"	AL

### Popular Sign Materials

- FB** - Premium Fiberglass (B-120)
  - SS** - Self-Sticking Polyester (B-302)
  - BGSS** - BradyGlo™ Self-Sticking Polyester (B-324)
  - BGPL** - BradyGlo™ Plastic (B-347)
  - PL** - Plastic (B-401)
  - AL** - Aluminum (B-555)
- View all sign materials on page 25.

### Can't find your sign?

Use the Sign Legend Index on page 498 or take advantage of our custom sign options.

### OSHA Regulations

#### Flammable: Keep Fire Away 1910.106(d)(3)(ii)

Storage cabinets in which you keep flammable liquids, such as gasoline, must be labeled in conspicuous lettering, "Flammable – Keep Fire Away."

#### Fire Extinguisher Marking 1910.157(c)(1)

If you are using portable fire extinguishers, you must mount, locate and identify them so that they are readily accessible to employees.

#### Fire Hose 1910.158(c)(1)

Where reels or cabinets are provided to contain fire hose, the employer must be sure that they are conspicuously identified and used only for fire equipment.

## Fire Safety Signs (Continued)



127112	7" x 10"	SS
127115	10" x 14"	SS
127111	7" x 10"	PL
127114	10" x 14"	PL
127110	7" x 10"	AL
127113	10" x 14"	AL



127118	7" x 10"	SS
127121	10" x 14"	SS
127117	7" x 10"	PL
127120	10" x 14"	PL
127116	7" x 10"	AL
127119	10" x 14"	AL



127136	7" x 10"	SS
127139	10" x 14"	SS
127135	7" x 10"	PL
127138	10" x 14"	PL
127134	7" x 10"	AL
127137	10" x 14"	AL



127124	7" x 10"	SS
127127	10" x 14"	SS
127123	7" x 10"	PL
127126	10" x 14"	PL
127122	7" x 10"	AL
127125	10" x 14"	AL



127130	7" x 10"	SS
127133	10" x 14"	SS
127129	7" x 10"	PL
127132	10" x 14"	PL
127128	7" x 10"	AL
127131	10" x 14"	AL



127142	7" x 10"	SS
127145	10" x 14"	SS
127141	7" x 10"	PL
127144	10" x 14"	PL
127140	7" x 10"	AL
127143	10" x 14"	AL



85225	10" x 14"	SS
43272	10" x 14"	AL



90103	7" x 10"	BGSS
90617	10" x 14"	BGSS
90629	10" x 14"	BGPL



85228	5" x 14"	SS
-------	----------	----



69168	10" x 14"	FB
85231	10" x 14"	SS
25696	7" x 10"	PL
43274	10" x 14"	AL



127148	7" x 10"	SS
127151	10" x 14"	SS
127147	7" x 10"	PL
127150	10" x 14"	PL
127146	7" x 10"	AL
127149	10" x 14"	AL



127166	7" x 10"	SS
127169	10" x 14"	SS
127165	7" x 10"	PL
127168	10" x 14"	PL
127164	7" x 10"	AL
127167	10" x 14"	AL



127154	7" x 10"	SS
127157	10" x 14"	SS
127153	7" x 10"	PL
127156	10" x 14"	PL
127152	7" x 10"	AL
127155	10" x 14"	AL



85236	7" x 10"	SS
85237	10" x 14"	SS
25700	7" x 10"	PL
25701	10" x 14"	PL
43277	7" x 10"	AL
43278	10" x 14"	AL



69202	10" x 14"	FB
85239	10" x 14"	SS
25702	7" x 10"	PL
43279	7" x 10"	AL



127160	10" x 7"	SS
127163	14" x 10"	SS
127159	10" x 7"	PL
127162	14" x 10"	PL
127158	10" x 7"	AL
127161	14" x 10"	AL

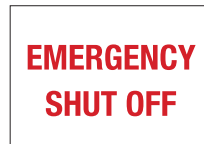

51545	10" x 14"	AL
-------	-----------	----



122870	7" x 10"	FB
122731	10" x 14"	FB
90372	7" x 10"	SS
122585	10" x 14"	SS
122535	7" x 10"	PL
122481	10" x 14"	PL
122426	7" x 10"	AL
122360	10" x 14"	AL

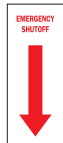

69206	24" x 4"	FB
85240	14" x 5"	SS
25703	14" x 10"	PL



85241	7" x 10"	SS
85242	10" x 14"	SS
25704	7" x 10"	PL
25705	10" x 14"	PL
43281	7" x 10"	AL
43282	10" x 14"	AL



95504	10" x 14"	AL
95505	14" x 20"	AL



127178	7" x 10"	SS
127181	10" x 14"	SS
127177	7" x 10"	PL
127180	10" x 14"	PL
127176	7" x 10"	AL
127179	10" x 14"	AL



127172	7" x 10"	SS
127175	10" x 14"	SS
127171	7" x 10"	PL
127174	10" x 14"	PL
127170	7" x 10"	AL
127173	10" x 14"	AL



90379	3-1/2" x 3-1/2"	SS
-------	-----------------	----



47273	7" x 10"	FB
85243	7" x 10"	SS
85244	10" x 14"	SS
25706	7" x 10"	PL
25707	10" x 14"	PL
43283	7" x 10"	AL
43284	10" x 14"	AL



90968	7" x 10"	BGPL
-------	----------	------



127184	7" x 10"	SS
127187	10" x 14"	SS
127183	7" x 10"	PL
127186	10" x 14"	PL
127182	7" x 10"	AL
127185	10" x 14"	AL

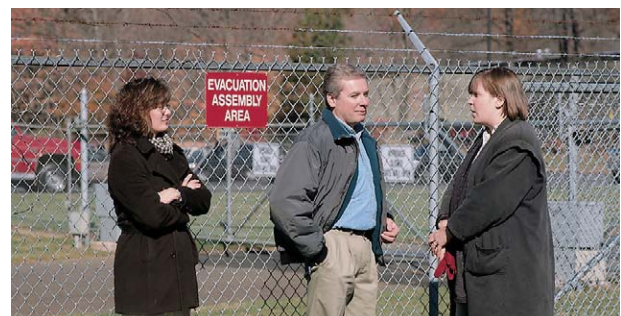

# Fire Safety Signs

BradyID.com/s34

## Fire Safety Signs (Continued)

Safety Signs



127190	7" x 10"	SS
127193	10" x 14"	SS
127189	7" x 10"	PL
127192	10" x 14"	PL
127188	7" x 10"	AL
127191	10" x 14"	AL



127340	7" x 10"	SS
127343	10" x 14"	SS
127339	7" x 10"	PL
127342	10" x 14"	PL
127338	7" x 10"	AL
127341	10" x 14"	AL



122873	7" x 10"	FB
69071	14" x 10"	FB
122665	7" x 10"	SS
86090	14" x 10"	SS
80161	14" x 10"	BGSS
80292	14" x 10"	BGPL
122538	7" x 10"	PL
25708	14" x 10"	PL
122429	7" x 10"	AL
43285	14" x 10"	AL
95147	14" x 10"	B-997



103599	14" x 3-1/2"	SS
90366	14" x 5"	SS
103598	14" x 3-1/2"	BGSS
80223	14" x 5"	BGSS
80291	14" x 5"	BGPL

### Popular Sign Materials

**FB** - Premium Fiberglass (B-120)  
**SS** - Self-Sticking Polyester (B-302)  
**BGSS** - BradyGlo™ Self-Sticking Polyester (B-324)  
**BGPL** - BradyGlo™ Plastic (B-347)  
**PL** - Plastic (B-401)  
**AL** - Aluminum (B-555)  
*View all sign materials on page 25.*

### Can't find your sign?

*Use the Sign Legend Index on page 498 or take advantage of our custom sign options.*



90976	5" x 14"	BGPL
-------	----------	------



90376	14" x 5"	SS
-------	----------	----



127196	7" x 10"	SS
127199	10" x 14"	SS
127195	7" x 10"	PL
127198	10" x 14"	PL
127194	7" x 10"	AL
127197	10" x 14"	AL



51546	10" x 14"	AL
-------	-----------	----



123775	10" x 7"	SS
123778	14" x 10"	SS
123774	10" x 7"	PL
123777	14" x 10"	PL
123773	10" x 7"	AL
123776	14" x 10"	AL



85248	7" x 10"	SS
85249	10" x 14"	SS
25709	7" x 10"	PL
25710	10" x 14"	PL
43286	7" x 10"	AL
43287	10" x 14"	AL



127226	7" x 10"	SS
127229	10" x 14"	SS
127225	7" x 10"	PL
127228	10" x 14"	PL
127224	7" x 10"	AL
127227	10" x 14"	AL



90100	7" x 10"	BGSS
90942	7" x 10"	BGPL
90626	10" x 14"	BGPL



90101	7" x 10"	BGSS
90943	7" x 10"	BGPL
90627	10" x 14"	BGPL



132148	7" x 10"	FB
132149	10" x 14"	FB
132150	7" x 10"	SS
132151	10" x 14"	SS
132144	7" x 10"	PL
132145	10" x 14"	PL
132146	7" x 10"	AL
132147	10" x 14"	AL



127214	7" x 10"	SS
127217	10" x 14"	SS
127213	7" x 10"	PL
127216	10" x 14"	PL
127212	7" x 10"	AL
127215	10" x 14"	AL



85253	7" x 10"	SS
85254	10" x 14"	SS
25711	7" x 10"	PL
25712	10" x 14"	PL
43288	7" x 10"	AL
43289	10" x 14"	AL



90377	14" x 5"	SS
-------	----------	----



90937	5" x 14"	BGPL
-------	----------	------



90625	10" x 14"	BGSS
90637	10" x 14"	BGPL
90953	10" x 14"	BGPL



90952	7" x 10"	BGPL
90636	10" x 14"	BGPL



84681	3-1/2" x 14"	SS
80225	3-1/2" x 10"	BGSS
80294	3-1/2" x 10"	BGPL
22495	10" x 14"	PL
41059	10" x 14"	AL



90946	7" x 10"	BGPL
90630	10" x 14"	BGPL



127232	7" x 10"	SS
127235	10" x 14"	SS
127231	7" x 10"	PL
127234	10" x 14"	PL
127230	7" x 10"	AL
127233	10" x 14"	AL



132140	7" x 10"	FB
132141	10" x 14"	FB
132142	7" x 10"	SS
132143	10" x 14"	SS
132136	7" x 10"	PL
132137	10" x 14"	PL
132138	7" x 10"	AL
132139	10" x 14"	AL











84682	7" x 10"	SS
84683	10" x 14"	SS
22496	7" x 10"	PL
22497	10" x 14"	PL
41060	7" x 10"	AL
41061	10" x 14"	AL













80229	3-1/2" x 10"	BGSS
80298	3-1/2" x 10"	BGPL
80299	5" x 14"	BGPL







## Fire Safety Signs (Continued)

			
80233 3-1/2" x 10" BGSS 80234 5" x 14" BGSS	47247 3-1/2" x 14" FB 84635 3-1/2" x 14" SS 22461 7" x 10" PL 41025 7" x 10" AL	80227 3-1/2" x 10" BGSS 80296 3-1/2" x 10" BGPL 80297 5" x 14" BGPL	80231 3-1/2" x 10" BGSS 80232 5" x 14" BGSS

			
47246 3-1/2" x 14" FB 84636 3-1/2" x 14" SS 22462 7" x 10" PL 41026 7" x 10" AL	71649 5" x 14" FB 85256 3-1/2" x 10" SS 85257 5" x 14" SS 80235 3-1/2" x 10" BGSS 80167 3-1/2" x 10" BGPL	122892 7" x 10" FB 122752 10" x 14" FB 122688 7" x 10" SS 122610 10" x 14" SS 25714 7" x 10" PL 122491 10" x 14" PL 43291 7" x 10" AL 122377 10" x 14" AL	71643 5" x 14" FB 85255 5" x 14" SS 25713 7" x 10" PL 43290 7" x 10" AL

			
91020 7" x 10" BGSS	123769 10" x 7" SS 123772 14" x 10" SS 123768 10" x 7" PL 123771 14" x 10" PL 123767 10" x 7" AL 123770 14" x 10" AL	69246 10" x 14" FB 85262 7" x 10" SS 85263 10" x 14" SS 25719 7" x 10" PL 25720 10" x 14" PL 43297 10" x 14" AL	123757 10" x 7" SS 123760 14" x 10" SS 124567 18" x 4" SS 123756 10" x 7" PL 123759 14" x 10" PL 124566 18" x 4" PL 123755 10" x 7" AL 123758 14" x 10" AL

					
90371 7" x 10" SS	85264 7" x 10" SS 85265 10" x 14" SS	86092 14" x 10" SS 25721 10" x 14" PL 43298 10" x 14" AL	80242 5" x 14" BGSS	85267 3-1/2" x 10" SS 85268 5" x 14" SS	127202 7" x 10" SS 127205 10" x 14" SS 127201 7" x 10" PL 127204 10" x 14" PL 127200 7" x 10" AL 127203 10" x 14" AL

					
73433 5" x 14" FB 85269 5" x 14" SS 25722 7" x 10" PL 43299 7" x 10" AL	127208 7" x 10" SS 127211 10" x 14" SS 127207 7" x 10" PL 127210 10" x 14" PL 127206 7" x 10" AL 127209 10" x 14" AL	122790 10" x 7" FB 122702 14" x 10" FB 122632 10" x 7" SS 90383 14" x 10" SS 122463 14" x 10" PL 122392 10" x 7" AL 122337 14" x 10" AL	123781 10" x 7" SS 123784 14" x 10" SS 123780 10" x 7" PL 123783 14" x 10" PL 123779 10" x 7" AL 123782 14" x 10" AL	69243 7" x 7" FB 88504 7" x 7" SS 25169 7" x 10" PL 42746 7" x 10" AL	90967 7" x 10" BGPL



51555 18" x 4" SS  
51556 18" x 4" PL  
Package includes 8 identical signs.



# Fire Safety Signs

BradyID.com/s34

## Fire Safety Signs (Continued)



123763	10" x 7"	SS
123766	14" x 10"	SS
123762	10" x 7"	PL
123765	14" x 10"	PL
123761	10" x 7"	AL
123764	14" x 10"	AL



124570	18" x 4"	SS
124569	18" x 4"	PL
124568	18" x 4"	AL



90373	7" x 10"	SS
-------	----------	----



47039	14" x 3-1/2"	FB
71655	24" x 4"	FB
85261	14" x 3-1/2"	SS
90367	14" x 5"	SS
80241	14" x 5"	BGSS
80460	14" x 5"	BGPL

### Popular Sign Materials

- FB** - Premium Fiberglass (B-120)
- SS** - Self-Sticking Polyester (B-302)
- BGSS** - BradyGlo™ Self-Sticking Polyester (B-324)
- BGPL** - BradyGlo™ Plastic (B-347)
- PL** - Plastic (B-401)
- AL** - Aluminum (B-555)

View all sign materials on page 25.

### Can't find your sign?

Use the Sign Legend Index on page 498 or take advantage of our custom sign options.



122775	10" x 7"	FB
122710	14" x 10"	FB
122627	10" x 7"	SS
122570	14" x 10"	SS
122471	14" x 10"	PL
25718	10" x 7"	PL
43295	10" x 7"	AL
122345	14" x 10"	AL



69074	14" x 10"	FB
86091	14" x 10"	SS
80162	14" x 10"	BGSS
80174	14" x 10"	BGPL
25717	14" x 10"	PL
43294	14" x 10"	AL
95146	14" x 10"	B-997



When wrapped around columns the word "Fire Extinguisher" is repeated 4 times. Or can be cut into four 14" x 7" single signs.



90975	5" x 14"	BGPL
-------	----------	------



25914	10" x 14"	PL
43491	10" x 14"	AL



78260	14" x 10"	BGSS
80173	14" x 10"	BGPL



85258	3-1/2" x 14"	SS
25715	7" x 10"	PL
43292	7" x 10"	AL



85259	3-1/2" x 14"	SS
25716	7" x 10"	PL
43293	7" x 10"	AL



80237	3-1/2" x 10"	BGSS
-------	--------------	------



90560	5" x 14"	BGSS
-------	----------	------



80243	5" x 14"	BGSS
47279	3-1/2" x 10"	FB
71688	5" x 14"	FB
85275	3-1/2" x 10"	SS
85276	5" x 14"	SS
43305	7" x 10"	AL



122794	7" x 10"	FB
73434	10" x 14"	FB
85277	7" x 10"	SS
85278	10" x 14"	SS
25729	7" x 10"	PL
122466	10" x 14"	PL
43306	7" x 10"	AL
122340	10" x 14"	AL



91031	7" x 10"	BGSS
90969	7" x 10"	BGPL



88505	7" x 7"	SS
25170	7" x 10"	PL
42747	7" x 10"	AL



127220	7" x 10"	SS
127223	10" x 14"	SS
127219	7" x 10"	PL
127222	10" x 14"	PL
127218	7" x 10"	AL
127221	10" x 14"	AL



122706	10" x 14"	FB
122566	10" x 14"	SS
122465	10" x 14"	PL
122339	10" x 14"	AL

### May we also suggest:

#### Fire-Changeable Arrow Sign

- Self-sticking arrow and sign offers the flexibility to place arrow in desired direction

Catalog #	Size	Description
70855	12" x 9"	Fiberglass Sign & Self-Sticking Arrow
89149	12" x 9"	Self-Sticking Sign and Arrow
43355	14" x 10"	Aluminum Sign and Arrow
38082	4" dia.	Self-Sticking Replacement Arrow





## Fire Safety Signs (Continued)



122774	10" x 7"	FB
122626	10" x 7"	SS
25723	10" x 7"	PL
43300	10" x 7"	AL



73483	24" x 4"	FB
85270	14" x 5"	SS
80244	14" x 5"	BGSS
85476	14" x 5"	BGPL



90384	14" x 10"	SS
-------	-----------	----



80160	14" x 10"	BGSS
85463	14" x 10"	BGPL



90558	5" x 14"	BGSS
90977	5" x 14"	BGPL



73481	10" x 14"	FB
85273	7" x 10"	SS
43303	7" x 10"	AL
43304	10" x 14"	AL



71046	10" x 14"	FB
85271	7" x 10"	SS
85272	10" x 14"	SS
43302	10" x 14"	AL



71732	10" x 14"	FB
85279	7" x 10"	SS
85280	10" x 14"	SS
25730	7" x 10"	PL
43307	7" x 10"	AL



90370	7" x 10"	SS
-------	----------	----



90106	7" x 10"	BGSS
90620	10" x 14"	BGSS
90948	7" x 10"	BGPL
90632	10" x 14"	BGPL



90576	5" x 14"	BGSS
90895	5" x 14"	BGPL



127244	7" x 10"	SS
127247	10" x 14"	SS
127243	7" x 10"	PL
127246	10" x 14"	PL
127242	7" x 10"	AL
127245	10" x 14"	AL



90988	5" x 14"	BGPL
-------	----------	------



90994	5" x 14"	BGPL
-------	----------	------



127250	7" x 10"	SS
127253	10" x 14"	SS
127249	7" x 10"	PL
127252	10" x 14"	PL
127248	7" x 10"	AL
127251	10" x 14"	AL



127262	7" x 10"	SS
127265	10" x 14"	SS
127261	7" x 10"	PL
127264	10" x 14"	PL
127260	7" x 10"	AL
127263	10" x 14"	AL



127238	7" x 10"	SS
127241	10" x 14"	SS
127237	7" x 10"	PL
127240	10" x 14"	PL
127236	7" x 10"	AL
127239	10" x 14"	AL



127268	7" x 10"	SS
127271	10" x 14"	SS
127267	7" x 10"	PL
127270	10" x 14"	PL
127266	7" x 10"	AL
127269	10" x 14"	AL



127274	10" x 7"	SS
127277	14" x 10"	SS
127273	10" x 7"	PL
127276	14" x 10"	PL
127272	10" x 7"	AL
127275	14" x 10"	AL



90930	5" x 14"	BGPL
-------	----------	------



90107	7" x 10"	BGSS
90781	7" x 10"	BGPL
90719	10" x 14"	BGPL



90554	10" x 7"	BGSS
90187	14" x 10"	BGSS
90718	10" x 7"	BGPL
90780	14" x 10"	BGPL



76870	7" x 7"	FB
122707	10" x 14"	FB
84684	7" x 7"	SS
122567	10" x 14"	SS
22498	7" x 10"	PL
122467	10" x 14"	PL
41062	7" x 10"	AL
122341	10" x 14"	AL

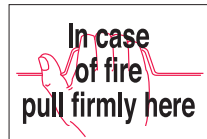

90380	5" x 7"	SS
-------	---------	----



127256	7" x 10"	SS
127259	10" x 14"	SS
127255	7" x 10"	PL
127258	10" x 14"	PL
127254	7" x 10"	AL
127257	10" x 14"	AL



# Fire Safety Signs

BradyID.com/s34

## Fire Safety Signs (Continued)

Safety Signs



127280	7" x 10"	SS
127283	10" x 14"	SS
127279	7" x 10"	PL
127282	10" x 14"	PL
127278	7" x 10"	AL
127281	10" x 14"	AL



127286	7" x 10"	SS
127289	10" x 14"	SS
127285	7" x 10"	PL
127288	10" x 14"	PL
127284	7" x 10"	AL
127287	10" x 14"	AL



127292	7" x 10"	SS
127295	10" x 14"	SS
127291	7" x 10"	PL
127294	10" x 14"	PL
127290	7" x 10"	AL
127293	10" x 14"	AL



71985	14" x 20"	FB
-------	-----------	----

**Popular Sign Materials**

**FB** - Premium Fiberglass (B-120)  
**SS** - Self-Sticking Polyester (B-302)  
**BGSS** - BradyGlo™ Self-Sticking Polyester (B-324)  
**BGPL** - BradyGlo™ Plastic (B-347)  
**PL** - Plastic (B-401)  
**AL** - Aluminum (B-555)

*View all sign materials on page 25.*

**Can't find your sign?**  
*Use the Sign Legend Index on page 498 or take advantage of our custom sign options.*



127298	7" x 10"	SS
127301	10" x 14"	SS
127297	7" x 10"	PL
127300	10" x 14"	PL
127296	7" x 10"	AL
127299	10" x 14"	AL



90993	5" x 14"	BGPL
-------	----------	------



51547	10" x 14"	AL
-------	-----------	----



127304	10" x 7"	SS
127307	14" x 10"	SS
127303	10" x 7"	PL
127306	14" x 10"	PL
127302	10" x 7"	AL
127305	14" x 10"	AL



69500	10" x 14"	FB
85297	7" x 10"	SS
85298	10" x 14"	SS
22690	7" x 10"	PL
22691	10" x 14"	PL
41254	7" x 10"	AL
41255	10" x 14"	AL



90573	5" x 14"	BGSS
90992	5" x 14"	BGPL



127310	7" x 10"	SS
127313	10" x 14"	SS
127309	7" x 10"	PL
127312	10" x 14"	PL
127308	7" x 10"	AL
127311	10" x 14"	AL



51549	10" x 14"	AL
-------	-----------	----



90996	5" x 14"	BGPL
-------	----------	------



90368	7" x 10"	SS
-------	----------	----



85299	3-1/2" x 10"	SS
22692	7" x 10"	PL
41256	7" x 10"	AL



71779	10" x 14"	FB
22693	7" x 10"	PL
41257	7" x 10"	AL



127322	7" x 10"	SS
127325	10" x 14"	SS
127321	7" x 10"	PL
127324	10" x 14"	PL
127320	7" x 10"	AL
127323	10" x 14"	AL



127316	7" x 10"	SS
127319	10" x 14"	SS
127315	7" x 10"	PL
127318	10" x 14"	PL
127314	7" x 10"	AL
127317	10" x 14"	AL



127328	7" x 10"	SS
127331	10" x 14"	SS
127327	7" x 10"	PL
127330	10" x 14"	PL
127326	7" x 10"	AL
127329	10" x 14"	AL



85305	10" x 14"	SS
22695	7" x 10"	PL
41260	10" x 14"	AL



127334	7" x 10"	SS
127337	10" x 14"	SS
127333	7" x 10"	PL
127336	10" x 14"	PL
127332	7" x 10"	AL
127335	10" x 14"	AL



90553	7" x 10"	BGSS
90186	10" x 14"	BGSS
90717	7" x 10"	BGPL



90185	10" x 14"	BGSS
-------	-----------	------



90386	5" x 14"	SS
-------	----------	----



## First Aid Signs

Brady first aid signs identify safety equipment and first aid stations. Designed with pictograms, bold text and bright colors, Brady's first aid signs clearly indicate the locations of first aid kits, safety showers, eyewash stations and other safety equipment. First aid signs reinforce safe work practices and ensure that your employees are prepared for accidents and emergencies.



74940	14" x 20"	FB
85308	10" x 14"	SS
22632	7" x 10"	PL
22633	10" x 14"	PL
41197	10" x 14"	AL



70227	10" x 14"	FB
85309	7" x 10"	SS
85310	10" x 14"	SS
22635	10" x 14"	PL
41198	7" x 10"	AL



85311	7" x 10"	SS
85312	10" x 14"	SS
22636	7" x 10"	PL
22637	10" x 14"	PL
41200	7" x 10"	AL
41201	10" x 14"	AL



127394	7" x 10"	SS
127397	10" x 14"	SS
127393	7" x 10"	PL
127396	10" x 14"	PL
127392	7" x 10"	AL
127395	10" x 14"	AL



127412	7" x 10"	SS
127415	10" x 14"	SS
127411	7" x 10"	PL
127414	10" x 14"	PL
127410	7" x 10"	AL
127413	10" x 14"	AL



127400	7" x 10"	SS
127403	10" x 14"	SS
127399	7" x 10"	PL
127402	10" x 14"	PL
127398	7" x 10"	AL
127401	10" x 14"	AL



127418	7" x 10"	SS
127421	10" x 14"	SS
127417	7" x 10"	PL
127420	10" x 14"	PL
127416	7" x 10"	AL
127419	10" x 14"	AL



127406	7" x 10"	SS
127409	10" x 14"	SS
127405	7" x 10"	PL
127408	10" x 14"	PL
127404	7" x 10"	AL
127407	10" x 14"	AL



69463	7" x 17"	FB
-------	----------	----



69088	7" x 17"	FB
-------	----------	----



74097	10" x 14"	FB
74966	14" x 20"	FB
85315	7" x 10"	SS
85316	10" x 14"	SS
22638	7" x 10"	PL
22639	10" x 14"	PL
41202	7" x 10"	AL
41203	10" x 14"	AL



85321	7" x 10"	SS
85322	10" x 14"	SS
22642	7" x 10"	PL
22643	10" x 14"	PL
41206	7" x 10"	AL
41207	10" x 14"	AL



47044	14" x 10"	FB
85323	10" x 7"	SS
85324	14" x 10"	SS
22644	10" x 7"	PL
22645	14" x 10"	PL
41208	10" x 7"	AL
41209	14" x 10"	AL



127430	7" x 10"	SS
127433	10" x 14"	SS
127429	7" x 10"	PL
127432	10" x 14"	PL
127428	7" x 10"	AL
127431	10" x 14"	AL



75962	10" x 7"	FB
75963	14" x 10"	FB
85325	10" x 7"	SS
85326	14" x 10"	SS
22646	10" x 7"	PL
22647	14" x 10"	PL
41210	10" x 7"	AL
41211	14" x 10"	AL



85327	7" x 10"	SS
85328	10" x 14"	SS
22648	7" x 10"	PL
22649	10" x 14"	PL
41213	10" x 14"	AL



127424	7" x 10"	SS
127427	10" x 14"	SS
127423	7" x 10"	PL
127426	10" x 14"	PL
127422	7" x 10"	AL
127425	10" x 14"	AL

**! OSHA Regulation**

**First Aid 1910.252(f)(13), 1910.151(b) (Informational Marking):** First aid supplies... shall be readily available.

**Emergency Eyewash and Shower 1910.151(c) (Informational Marking):** Suitable facilities for quick drenching or flushing of the eyes and body must be provided in the work area for emergency use if workers are exposed to injurious corrosive materials.

**Appendix A (non-mandatory appendix) to 1910.1450:** The National Research Council Recommendations Concerning Chemical Hygiene in Laboratories, recommends that location signs for safety showers, eyewash stations and other safety and first aid equipment be posted.

**Respirators 1910.134(f)(5)(i):** Respirators placed at stations and work areas for emergency use should be quickly accessible at all times and should be stored in compartments built for this purpose. The compartments should be clearly marked.



# First Aid Signs

BradyID.com/s34

## First Aid Signs (Continued)

Safety Signs

### SAFETY FIRST PERSONAL EYEWASH

127436	7" x 10"	SS
127439	10" x 14"	SS
127435	7" x 10"	PL
127438	10" x 14"	PL
127434	7" x 10"	AL
127437	10" x 14"	AL

### SAFETY FIRST REPORT ALL ACCIDENTS NO MATTER HOW SMALL TO YOUR FOREMAN

122722	10" x 14"	FB
85331	7" x 10"	SS
85332	10" x 14"	SS
22650	7" x 10"	PL
22651	10" x 14"	PL
41214	7" x 10"	AL
41215	10" x 14"	AL

### SAFETY FIRST REPORT ALL INJURIES NO MATTER HOW SLIGHT TO FIRST AID STATION

85333	7" x 10"	SS
85334	10" x 14"	SS
22652	7" x 10"	PL
22653	10" x 14"	PL
41217	10" x 14"	AL

### SAFETY FIRST SAFETY SHOWER AND EYEWASH STATION

22654	7" x 10"	PL
22655	10" x 14"	PL
73493	14" x 20"	FB
85337	7" x 10"	SS
85338	10" x 14"	SS
41218	7" x 10"	AL
41219	10" x 14"	AL

### Popular Sign Materials

- FB** - Premium Fiberglass (B-120)
  - SS** - Self-Sticking Polyester (B-302)
  - BGSS** - BradyGlo™ Self-Sticking Polyester (B-324)
  - BGPL** - BradyGlo™ Plastic (B-347)
  - PL** - Plastic (B-401)
  - AL** - Aluminum (B-555)
- View all sign materials on page 25.*

**Can't find your sign?**  
Use the Sign Legend Index on page 498 or take advantage of our custom sign options.

### SAFETY FIRST SHOWER STATION

127442	7" x 10"	SS
127445	10" x 14"	SS
127441	7" x 10"	PL
127444	10" x 14"	PL
127440	7" x 10"	AL
127443	10" x 14"	AL

### THINK REPORT ALL INJURIES TO YOUR SUPERVISOR

127448	7" x 10"	SS
127451	10" x 14"	SS
127447	7" x 10"	PL
127450	10" x 14"	PL
127446	7" x 10"	AL
127449	10" x 14"	AL

### EMERGENCY BREATHING APPARATUS INSIDE

99326	10" x 14"	FB
85343	7" x 10"	SS
85344	10" x 14"	SS
22656	7" x 10"	PL
41220	7" x 10"	AL
41221	10" x 14"	AL

### EMERGENCY SHOWER

73442	5" x 14"	FB
85346	5" x 14"	SS
22659	10" x 14"	PL
41223	10" x 14"	AL

### EMERGENCY SHOWER AND EYE WASH

87662	10" x 14"	FB
29067	7" x 10"	SS
29079	10" x 14"	SS
29069	7" x 10"	PL
29081	10" x 14"	PL
29076	7" x 10"	AL
29082	10" x 14"	AL

### EMERGENCY TELEPHONE INFORMATION

43511	10" x 14"	AL
-------	-----------	----

### EYE WASH

43511	10" x 14"	AL
122853	7" x 10"	FB
72700	10" x 14"	FB
87785	3-1/2" x 5"	SS
85349	7" x 10"	SS
85350	10" x 14"	SS
22661	7" x 10"	PL
22662	10" x 14"	PL
41225	7" x 10"	AL
41226	10" x 14"	AL



### EYE WASH

122871	7" x 10"	FB
122732	10" x 14"	FB
122662	7" x 10"	SS
122586	10" x 14"	SS
122536	7" x 10"	PL
122482	10" x 14"	PL
122427	7" x 10"	AL
122361	10" x 14"	AL

### EYE WASH FOUNTAIN

72708	10" x 14"	FB
85352	7" x 10"	SS
85353	10" x 14"	SS
22663	7" x 10"	PL
22664	10" x 14"	PL
41227	7" x 10"	AL

### EYE WASH STATION

72722	7" x 10"	FB
122720	10" x 14"	FB
87786	3-1/2" x 5"	SS
85354	7" x 10"	SS
85355	10" x 14"	SS
22665	7" x 10"	PL
122473	10" x 14"	PL
41229	7" x 10"	AL
122349	10" x 14"	AL

### EYE WASH STATION

122911	7" x 10"	FB
69232	7" x 17"	FB
122734	10" x 14"	FB
122664	7" x 10"	SS
122588	10" x 14"	SS
122537	7" x 10"	PL
25904	10" x 14"	PL
122428	7" x 10"	AL
43481	10" x 14"	AL

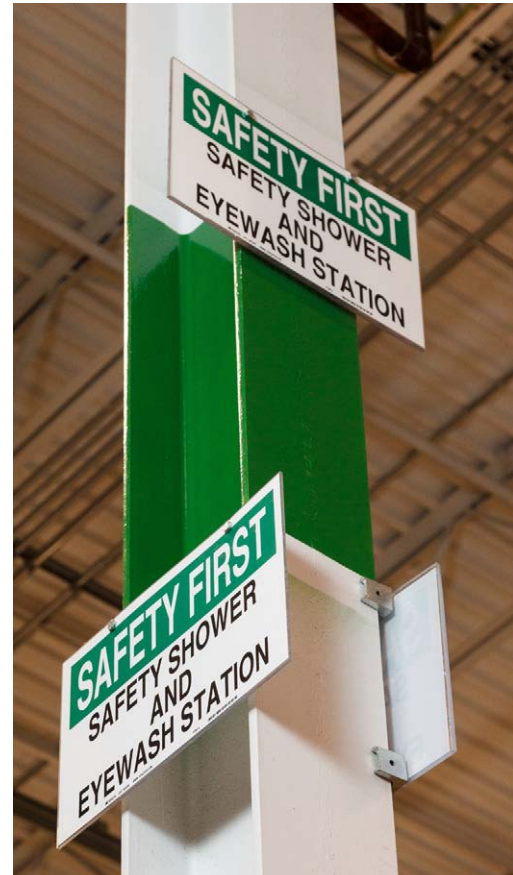

## First Aid Signs (Continued)



85356	3-1/2" x 10"	SS
22666	7" x 10"	PL
41230	7" x 10"	AL



69250	7" x 17"	FB
-------	----------	----



85359	3-1/2" x 10"	SS
22669	7" x 10"	PL
41233	7" x 10"	AL



73538	3-1/2" x 10"	BGSS
80245	5" x 14"	BGSS
85478	5" x 14"	BGPL



70345	3-1/2" x 10"	FB
85360	3-1/2" x 10"	SS
22670	7" x 10"	PL



122902	7" x 10"	FB
122764	10" x 14"	FB
85361	3-1/2" x 10"	SS
122694	7" x 10"	SS
122618	10" x 14"	SS
22671	7" x 10"	PL
122495	10" x 14"	PL
122451	7" x 10"	AL
122382	10" x 14"	AL



123751	10" x 7"	SS
123754	14" x 10"	SS
123750	10" x 7"	PL
123753	14" x 10"	PL
123749	10" x 7"	AL
123752	14" x 10"	AL



70347	10" x 14"	FB
85362	7" x 10"	SS
85363	10" x 14"	SS
22672	7" x 10"	PL
22673	10" x 14"	PL
41236	7" x 10"	AL
41237	10" x 14"	AL



Safety Signs



85358	3-1/2" x 14"	SS
22668	7" x 10"	PL
41232	7" x 10"	AL



85357	5" x 14"	SS
22667	7" x 10"	PL
41231	7" x 10"	AL

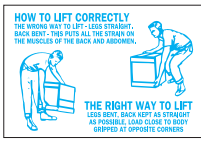

85370	7" x 10"	SS
85371	10" x 14"	SS
22680	7" x 10"	PL
22681	10" x 14"	PL
41244	7" x 10"	AL
41245	10" x 14"	AL

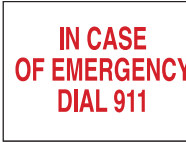

76095	7" x 10"	FB
76096	10" x 14"	FB
85368	7" x 10"	SS
85369	10" x 14"	SS
22678	7" x 10"	PL
22679	10" x 14"	PL
41243	10" x 14"	AL



127376	10" x 7"	SS
127379	14" x 10"	SS
127375	10" x 7"	PL
127378	14" x 10"	PL
127374	10" x 7"	AL
127377	14" x 10"	AL



85375	10" x 14"	SS
22684	7" x 10"	PL
22685	10" x 14"	PL
41248	7" x 10"	AL
41249	10" x 14"	AL



122858	7" x 10"	FB
72897	7" x 20"	FB
72883	10" x 14"	FB
85377	7" x 10"	SS
85378	10" x 14"	SS
22686	7" x 10"	PL
122475	10" x 14"	PL
41250	7" x 10"	AL
122351	10" x 14"	AL



88528	7" x 7"	SS
42766	7" x 10"	AL



127388	7" x 10"	SS
127391	10" x 14"	SS
127387	7" x 10"	PL
127390	10" x 14"	PL
127386	7" x 10"	AL
127389	10" x 14"	AL



127382	10" x 7"	SS
127385	14" x 10"	SS
127381	10" x 7"	PL
127384	14" x 10"	PL
127380	10" x 7"	AL
127383	14" x 10"	AL



90607	5" x 14"	BGSS
90935	5" x 14"	BGPL



# Floor Signs

BradyID.com/s34

## Floor Signs

Brady floor safety signs are a durable, highly visible way to communicate important safety and warning messages in your facility. Safety floor decals can be used to provide direction, point to exits, and provide warnings for enhanced workplace safety. Brady floor signs feature a strong adhesive backing that sticks to almost any dry, clean surface, as well as a clear anti-slip surface that helps prevent accidental falls. These floor signs are 17 inches in diameter and available in a variety of colors and messages.

### Floor Sign Materials

**BGSS** - BradyGlo™ Anti-Slip Polyester Floor Sign (B-808)  
**SS** - Anti-Slip Vinyl Floor Sign (B-819)  
 View all sign materials on page 25.



97616 17" dia. SS



13284 17" dia. SS



92400 17" dia. SS

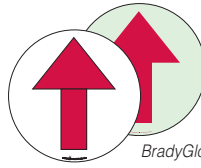

49057 17" dia. BGSS  
49058 17" dia. SS



47437 17" dia. SS



49806 17" dia. BGSS  
49805 17" dia. SS



49801 17" dia. SS



92405 17" dia. SS

**! OSHA Regulation**

**Phosphorescent Floor Signs address section 4.2.1 Floor Mounted Markings**

The ASTM guide for recommended uses of Photoluminescent safety markings describes recommended uses and information on installation of photoluminescent safety markings to supplement emergency lighting.



49067 17" dia. SS



49068 17" dia. SS



49061 17" dia. BGSS  
49060 17" dia. SS



92406 17" dia. SS



97609 17" dia. SS



49065 17" dia. SS

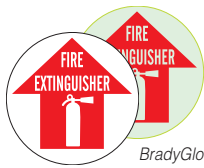

49062 17" dia. BGSS  
49064 17" dia. SS



49066 17" dia. SS



29294 17" dia. SS



49063 17" dia. SS



92407 17" dia. SS



97610 17" dia. SS



97611 17" dia. SS



97613 17" dia. SS



92408 17" dia. SS



29296 17" dia. SS



97614 17" dia. SS



97615 17" dia. SS



92404 17" dia. SS



49807 17" dia. SS

## Toughstripe® Floor Marking Signs

Toughstripe B-534 polyester floor signs resist harsh chemicals and are specifically designed to alert workers of potential dangers and enforce protective equipment requirements.

- Exceeds safety standards for clean, dry non-slip surfaces per ANSI A1264.2-2006 and OSHA 1910.22
- 3 mil thickness; Service temperature range of 0°F – 129°F
- Black areas of signs are coated with anti-skid tread
- US Patent No: 8,302,337



104489 17" dia. TS    104495 17" dia. TS    104496 17" dia. TS    104490 17" dia. TS    104492 17" dia. TS    104493 17" dia. TS    104494 17" dia. TS



104509 17" dia. TS    104501 17" dia. TS    104512 17" dia. TS    104513 17" dia. TS    104486 17" dia. TS    104487 17" dia. TS    104507 17" dia. TS



104511 17" dia. TS    104508 17" dia. TS    104488 14" x 18" TS    104491 14" x 18" TS    104497 14" x 18" TS    104498 14" x 18" TS    104499 14" x 18" TS



104500 14" x 18" TS    104502 14" x 18" TS    104503 14" x 18" TS    104504 14" x 18" TS    104505 14" x 18" TS    104506 14" x 18" TS    104510 14" x 18" TS

### Watch Toughstripe® Floor Marking Material in Action

ToughStripe® Floor Marking Tape is test-proven to withstand forklift traffic better than other tape-based floor marking products. That means less tearing. Less lifting. And less time re-applying your floor marking.

Visit [BradyID.com/toughstripe](http://BradyID.com/toughstripe) to view the video.



# Funny Signs

BradyID.com/s34

## Funny Signs

Brady funny signs are a great way to bring a bit of humor into your office or facility. These funny signs look exactly like our traditional sign products, but feature humorous messages, pictures, and sayings that are bound to make you laugh. Funny signs are a perfect gift for fellow employees and can lighten the mood in the office.

### Popular Sign Materials

- FB** - Premium Fiberglass (B-120)
- SS** - Self-Sticking Polyester (B-302)
- BGSS** - BradyGlo™ Self-Sticking Polyester (B-324)
- BGPL** - BradyGlo™ Plastic (B-347)
- PL** - Plastic (B-401)
- AL** - Aluminum (B-555)

*View all sign materials on page 25.*

### Can't find your sign?

*Use the Sign Legend Index on page 498 or take advantage of our custom sign options.*



38083 7' x 10' PL



38040 10' x 7' PL



38052 7' x 10' PL



38055 7' x 10' PL



38047 7' x 10' PL



38067 7' x 10' PL



38056 7' x 10' PL



38062 7' x 10' PL



38061 7' x 10' PL



49035 7' x 10' PL



38065 10' x 7' PL



38086 7' x 10' PL



38084 7' x 10' PL



38069 7' x 10' PL



38085 10' x 7' PL



38068 10' x 7' PL

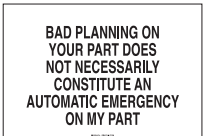

38071 7' x 10' PL



38077 10' x 7' PL



38075 10' x 7' PL



38076 10' x 7' PL

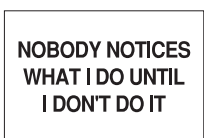

38073 7' x 10' PL



38072 14' x 10' PL

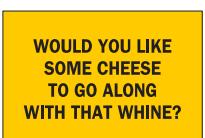

38087 7' x 10' PL



### Create Your Own Funny Sign!

With Brady's "same-as-stock" pricing, you can create your own funny sign for the same price as a stock sign.

For more information contact Brady Customer Service at 1-888-272-3946.





## High Visibility Signs

Brady high visibility signs feature bright colors, graphics and pictograms to effectively communicate a safety message or identify the location of tornado shelters, safety showers and first aid kits. These high visibility "V" and "L" shaped signs are designed to be seen from all access points in your facility.

**High Visibility Sign Styles**

L-Style 90° and V-Style 45° High Visibility signs are used to clearly mark fire safety equipment for quick and easy access in an emergency situation.



**L-Style 90° Angle**  
(Legend appears on both sides)

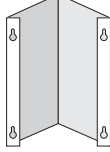

**V-Style 45° Angle**  
(Legend repeated on outward facing side)

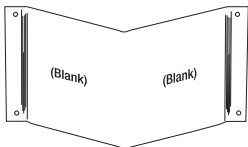

60499 12' x 18" PL

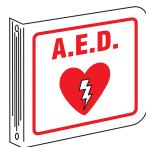

LOAE01A 8" x 8" PL



V1AE01A 6" x 9" x 4" PL



132239 6" x 9" x 4" PL



V1DS24A 6" x 9" x 4" PL



V1EP24A 6" x 9" x 4" PL



45369 5-1/2" x 10" x 4" PL



V1ESG1G 6" x 9" x 4" PL



45379 12" x 18" x 8" PL



50684 4" x 12" PL



V2EX01A 8" x 15" x 6" PL



45422 12" x 9" PL

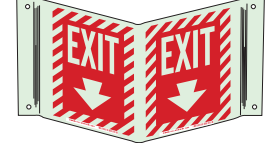

94022 12" x 9" BGPL



45363 5-1/2" x 10" x 4" PL  
80704 12" x 18" x 8" PL



LOEW03A 8" x 8" PL  
49041 12" x 9" PL



V1EW03A 6" x 9" x 4" PL  
49044 12" x 18" PL



V1EWG1G 6" x 9" x 4" PL



V3EW03A 11" x 12" x 5" PL



94027 12" x 9" BGPL  
70997 12" x 9" PL



96907 12" x 18" PL



50783 18" x 7-1/2" PL



45365 5-1/2" x 10" x 4" PL



LOFL15A 8" x 8" PL



V1FL15A 6" x 9" x 4" PL



50688 12" x 4" BGPL  
50689 18" x 14" PL



50778 18" x 7-1/2" BGPL  
50777 18" x 7-1/2" PL



50786 18" x 7-1/2" BGPL  
50785 18" x 7-1/2" PL



SP184L 18" x 4-1/2" PL



SP818V 18" x 8-1/2" x 3-1/4" PL



Safety Signs

# High Visibility Signs

BradyID.com/s34

## High Visibility Signs (Continued)



94008 12" x 9" BGPL  
70998 12" x 9" PL



96908 12" x 18" PL



94044 12" x 9" BGPL

### Popular Sign Materials

- FB** - Premium Fiberglass (B-120)
- SS** - Self-Sticking Polyester (B-302)
- BGSS** - BradyGlo™ Self-Sticking Polyester (B-324)
- BGPL** - BradyGlo™ Plastic (B-347)
- PL** - Plastic (B-401)
- AL** - Aluminum (B-555)

View all sign materials on page 25.

### Can't find your sign?

Use the Sign Legend Index on page 498 or take advantage of our custom sign options.



45366 5-1/2" x 10" x 4" PL  
80702 8" x 14-1/2" x 6" PL



45368 5-1/2" x 10" x 4" PL  
80703 8" x 14-1/2" x 6" PL



L0FEG1G 8" x 8" PL



V1FEG1G 6" x 9" x 4" PL



L0FE15A 8" x 8" PL



V1FE15A 6" x 8" x 4" PL



50692 12" x 4" BGPL  
50694 18" x 4" BGPL  
50691 12" x 4" PL  
50693 18" x 4" PL



L3FE15A 11" x 17" PL



V3FE15A 11" x 12" x 5" PL

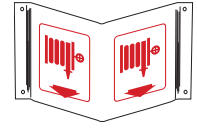

132222 6" x 9" x 4" PL

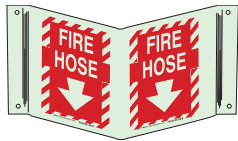

94029 12" x 9" BGPL



70999 12" x 9" PL



50784 18" x 7-1/2" BGPL



V1FHG1G 6" x 9" x 4" PL



50696 12" x 4" BGPL  
50698 18" x 4" BGPL  
50695 12" x 4" PL  
50697 18" x 4" PL



94054 12" x 9" BGPL



94014 12" x 9" BGPL  
45370 5-1/2" x 10" x 4" PL



50685 4" x 12" PL



45367 5-1/2" x 10" x 4" PL



45375 8" x 14-1/2" x 6" PL



V1LS01A 6" x 9" x 4" PL

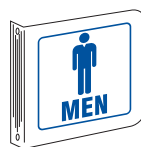

L0ME02A 8" x 8" PL



V1ME02A 6" x 9" x 4" PL



V2MS24A 8" x 15" x 6" PL

## High Visibility Signs (Continued)



V2MS21A 8" x 14-1/2" x 6" PL



45378 8" x 14-1/2" x 6" PL



V1MS03A 6" x 9" x 4" PL  
49045 12.5" x 18" PL



LOMS03A 8" x 8" PL  
49042 12.5" x 9" PL



V1CP45A 6" x 9" x 4" PL



45376 8" x 14-1/2" x 6" PL



LOPH02A 8" x 8" PL



V1PH02A 6" x 9" x 4" PL



V1RR02A 6" x 9" x 4" PL



V1RR45A 6" x 9" x 4" PL



45377 8" x 14-1/2" x 6" PL



80705 12" x 18" x 8" PL



LOSS03A 8" x 8" PL



V1SS03A 6" x 9" x 4" PL  
49043 12" x 18" PL



V1SS4G 6" x 9" x 4" PL



LOSWG4G 8" x 8" PL



V1SWG4G 6" x 9" x 4" PL



LOSR03A 8" x 8" PL



V1SR03A 6" x 9" x 4" PL



V2SS24A 8" x 15" x 6" PL



V1TOG1G 6" x 9" x 4" PL



LOTS024A 8" x 8" PL



V1TS024A 6" x 9" x 4" PL



V1WH45A 6" x 9" x 4" PL



45373 5-1/2" x 10" x 4" PL



L0WO02A 8" x 8" PL



V1WO45A 6" x 9" x 4" PL



Safety Signs

# Hospital Signs

BradyID.com/s34

## Hospital Signs

Brady hospital signs feature universal wayfinding symbols for visitors of all languages to clearly direct visitors to their destination. Hospital wayfinding signs are a great alternative to bi/trilingual signs, which are often difficult to read. Brady wayfinding signs can be customized by size, color and text and are available in aluminum, plastic and self-sticking materials.

### Popular Sign Materials

- FB** - Premium Fiberglass (B-120)
  - SS** - Self-Sticking Polyester (B-302)
  - BGSS** - BradyGlo™ Self-Sticking Polyester (B-324)
  - BGPL** - BradyGlo™ Plastic (B-347)
  - PL** - Plastic (B-401)
  - AL** - Aluminum (B-555)
- View all sign materials on page 25.*

### Can't find your sign?

*Use the Sign Legend Index on page 498 or take advantage of our custom sign options.*

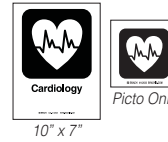
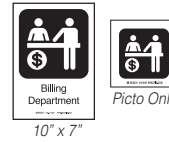
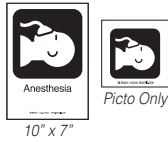
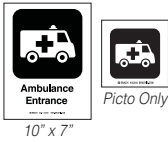
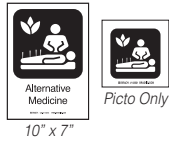
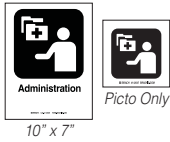

142647	4" x 4"	SS
142593	8" x 8"	SS
142539	10" x 7"	SS
142485	10" x 7"	PL
142431	10" x 7"	AL

142621	4" x 4"	SS
142567	8" x 8"	SS
142513	10" x 7"	SS
142459	10" x 7"	PL
142405	10" x 7"	AL

142644	4" x 4"	SS
142590	8" x 8"	SS
142536	10" x 7"	SS
142482	10" x 7"	PL
142428	10" x 7"	AL

142640	4" x 4"	SS
142586	8" x 8"	SS
142532	10" x 7"	SS
142478	10" x 7"	PL
142424	10" x 7"	AL

142649	4" x 4"	SS
142595	8" x 8"	SS
142541	10" x 7"	SS
142487	10" x 7"	PL
142433	10" x 7"	AL

142633	4" x 4"	SS
142579	8" x 8"	SS
142525	10" x 7"	SS
142471	10" x 7"	PL
142417	10" x 7"	AL

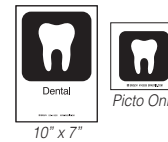
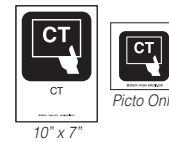
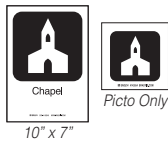
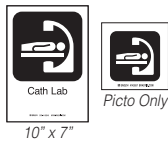
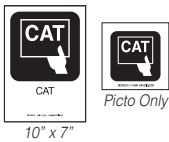

142612	4" x 4"	SS
142558	8" x 8"	SS
142504	10" x 7"	SS
142450	10" x 7"	PL
142396	10" x 7"	AL

142664	4" x 4"	SS
142610	8" x 8"	SS
142556	10" x 7"	SS
142502	10" x 7"	PL
142448	10" x 7"	AL

142657	4" x 4"	SS
142603	8" x 8"	SS
142549	10" x 7"	SS
142495	10" x 7"	PL
142441	10" x 7"	AL

142654	4" x 4"	SS
142600	8" x 8"	SS
142546	10" x 7"	SS
142492	10" x 7"	PL
142438	10" x 7"	AL

142663	4" x 4"	SS
142609	8" x 8"	SS
142555	10" x 7"	SS
142501	10" x 7"	PL
142447	10" x 7"	AL

142639	4" x 4"	SS
142585	8" x 8"	SS
142531	10" x 7"	SS
142477	10" x 7"	PL
142423	10" x 7"	AL

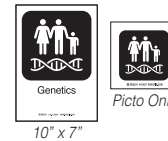
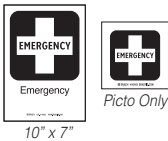
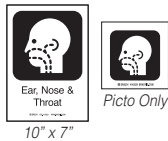
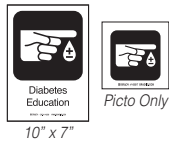
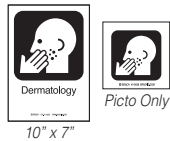

142628	4" x 4"	SS
142574	8" x 8"	SS
142520	10" x 7"	SS
142466	10" x 7"	PL
142412	10" x 7"	AL

142617	4" x 4"	SS
142563	8" x 8"	SS
142509	10" x 7"	SS
142455	10" x 7"	PL
142401	10" x 7"	AL

142629	4" x 4"	SS
142575	8" x 8"	SS
142521	10" x 7"	SS
142467	10" x 7"	PL
142413	10" x 7"	AL

142643	4" x 4"	SS
142589	8" x 8"	SS
142535	10" x 7"	SS
142481	10" x 7"	PL
142427	10" x 7"	AL

142618	4" x 4"	SS
142564	8" x 8"	SS
142510	10" x 7"	SS
142456	10" x 7"	PL
142402	10" x 7"	AL

142637	4" x 4"	SS
142583	8" x 8"	SS
142529	10" x 7"	SS
142475	10" x 7"	PL
142421	10" x 7"	AL

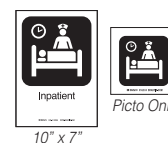
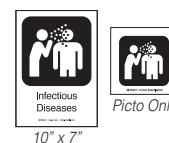
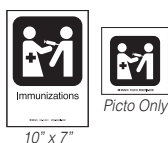
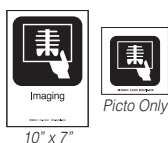
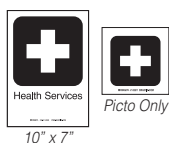
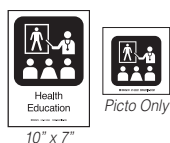

142651	4" x 4"	SS
142597	8" x 8"	SS
142543	10" x 7"	SS
142489	10" x 7"	PL
142435	10" x 7"	AL

142611	4" x 4"	SS
142557	8" x 8"	SS
142503	10" x 7"	SS
142449	10" x 7"	PL
142395	10" x 7"	AL





























































142660	4" x 4"	SS
142606	8" x 8"	SS
142552	10" x 7"	SS
142498	10" x 7"	PL
142444	10" x 7"	AL

142619	4" x 4"	SS
142565	8" x 8"	SS
142511	10" x 7"	SS
142457	10" x 7"	PL
142403	10" x 7"	AL

142638	4" x 4"	SS
142584	8" x 8"	SS
142530	10" x 7"	SS
142476	10" x 7"	PL
142422	10" x 7"	AL

142614	4" x 4"	SS
142560	8" x 8"	SS
142506	10" x 7"	SS
142452	10" x 7"	PL
142398	10" x 7"	AL

## Hospital Signs (Continued)

											
10" x 7"		10" x 7"		10" x 7"		10" x 7"		10" x 7"		10" x 7"	
142613	4" x 4" SS	142631	4" x 4" SS	142652	4" x 4" SS	142632	4" x 4" SS	142622	4" x 4" SS	142656	4" x 4" SS
142559	8" x 8" SS	142577	8" x 8" SS	142598	8" x 8" SS	142578	8" x 8" SS	142568	8" x 8" SS	142602	8" x 8" SS
142505	10" x 7" SS	142523	10" x 7" SS	142544	10" x 7" SS	142524	10" x 7" SS	142514	10" x 7" SS	142548	10" x 7" SS
142451	10" x 7" PL	142469	10" x 7" PL	142490	10" x 7" PL	142470	10" x 7" PL	142460	10" x 7" PL	142494	10" x 7" PL
142397	10" x 7" AL	142415	10" x 7" AL	142436	10" x 7" AL	142416	10" x 7" AL	142406	10" x 7" AL	142440	10" x 7" AL
											
10" x 7"		10" x 7"		10" x 7"		10" x 7"		10" x 7"		10" x 7"	
142650	4" x 4" SS	142648	4" x 4" SS	142626	4" x 4" SS	142661	4" x 4" SS	142658	4" x 4" SS	142627	4" x 4" SS
142596	8" x 8" SS	142594	8" x 8" SS	142572	8" x 8" SS	142607	8" x 8" SS	142604	8" x 8" SS	142573	8" x 8" SS
142542	10" x 7" SS	142540	10" x 7" SS	142518	10" x 7" SS	142553	10" x 7" SS	142550	10" x 7" SS	142519	10" x 7" SS
142488	10" x 7" PL	142486	10" x 7" PL	142464	10" x 7" PL	142499	10" x 7" PL	142496	10" x 7" PL	142465	10" x 7" PL
142434	10" x 7" AL	142432	10" x 7" AL	142410	10" x 7" AL	142445	10" x 7" AL	142442	10" x 7" AL	142411	10" x 7" AL
											
10" x 7"		10" x 7"		10" x 7"		10" x 7"		10" x 7"		10" x 7"	
142620	4" x 4" SS	142635	4" x 4" SS	142624	4" x 4" SS	142625	4" x 4" SS	142615	4" x 4" SS	142623	4" x 4" SS
142566	8" x 8" SS	142581	8" x 8" SS	142570	8" x 8" SS	142571	8" x 8" SS	142561	8" x 8" SS	142569	8" x 8" SS
142512	10" x 7" SS	142527	10" x 7" SS	142516	10" x 7" SS	142517	10" x 7" SS	142507	10" x 7" SS	142515	10" x 7" SS
142458	10" x 7" PL	142473	10" x 7" PL	142462	10" x 7" PL	142463	10" x 7" PL	142453	10" x 7" PL	142461	10" x 7" PL
142404	10" x 7" AL	142419	10" x 7" AL	142408	10" x 7" AL	142409	10" x 7" AL	142399	10" x 7" AL	142407	10" x 7" AL
											
10" x 7"		10" x 7"		10" x 7"		10" x 7"		10" x 7"		10" x 7"	
142636	4" x 4" SS	142662	4" x 4" SS	142616	4" x 4" SS	142642	4" x 4" SS	142655	4" x 4" SS	142645	4" x 4" SS
142582	8" x 8" SS	142608	8" x 8" SS	142562	8" x 8" SS	142588	8" x 8" SS	142601	8" x 8" SS	142591	8" x 8" SS
142528	10" x 7" SS	142554	10" x 7" SS	142508	10" x 7" SS	142534	10" x 7" SS	142547	10" x 7" SS	142537	10" x 7" SS
142474	10" x 7" PL	142500	10" x 7" PL	142454	10" x 7" PL	142480	10" x 7" PL	142493	10" x 7" PL	142483	10" x 7" PL
142420	10" x 7" AL	142446	10" x 7" AL	142400	10" x 7" AL	142426	10" x 7" AL	142439	10" x 7" AL	142429	10" x 7" AL
											
10" x 7"		10" x 7"		10" x 7"		10" x 7"		10" x 7"		10" x 7"	
142630	4" x 4" SS	142653	4" x 4" SS	142641	4" x 4" SS	142659	4" x 4" SS	142646	4" x 4" SS	142634	4" x 4" SS
142576	8" x 8" SS	142599	8" x 8" SS	142587	8" x 8" SS	142605	8" x 8" SS	142592	8" x 8" SS	142580	8" x 8" SS
142522	10" x 7" SS	142545	10" x 7" SS	142533	10" x 7" SS	142551	10" x 7" SS	142538	10" x 7" SS	142526	10" x 7" SS
142468	10" x 7" PL	142491	10" x 7" PL	142479	10" x 7" PL	142497	10" x 7" PL	142484	10" x 7" PL	142472	10" x 7" PL
142414	10" x 7" AL	142437	10" x 7" AL	142425	10" x 7" AL	142443	10" x 7" AL	142430	10" x 7" AL	142418	10" x 7" AL

# Lockout Tagout Signs

BradyID.com/s34

## Lockout Tagout Signs

Brady lockout tagout signs are high quality, industrial-strength safety signs for identifying machinery and equipment that require lockout. These lockout tagout signs can identify energy sources, provide lockout instructions, and serve as a reminder for safe lockout tagout procedures. In addition, lockout tagout signs create a safer and a more efficient workplace for employees.

### Popular Sign Materials

- FB** - Premium Fiberglass (B-120)
- SS** - Self-Sticking Polyester (B-302)
- BGSS** - BradyGlo™ Self-Sticking Polyester (B-324)
- BGPL** - BradyGlo™ Plastic (B-347)
- PL** - Plastic (B-401)
- AL** - Aluminum (B-555)
- MAG** - Magnetic Vinyl (B-811)
- SSV** - Self-Sticking Vinyl (B-946)

*View all sign materials on page 25.*

### Can't find your sign?

*Use the Sign Legend Index on page 498 or take advantage of our custom sign options.*

Safety Signs



69763 10" x 14" FB  
85754 7" x 10" SS  
85755 10" x 14" SS



127484 7" x 10" SS  
127487 10" x 14" SS  
127483 7" x 10" PL  
127486 10" x 14" PL  
127482 7" x 10" AL  
127485 10" x 14" AL



127490 7" x 10" SS  
127493 10" x 14" SS  
127489 7" x 10" PL  
127492 10" x 14" PL  
127488 7" x 10" AL  
127491 10" x 14" AL



60175 2-1/4" x 4-1/2" SSV



127496 7" x 10" SS  
127499 10" x 14" SS  
127495 7" x 10" PL  
127498 10" x 14" PL  
127494 7" x 10" AL  
127497 10" x 14" AL



60162 2" x 2" SSV



127502 7" x 10" SS  
127505 10" x 14" SS  
127501 7" x 10" PL  
127504 10" x 14" PL  
127500 7" x 10" AL  
127503 10" x 14" AL



127508 7" x 10" SS  
127511 10" x 14" SS  
127507 7" x 10" PL  
127510 10" x 14" PL  
127506 7" x 10" AL  
127509 10" x 14" AL



127514 7" x 10" SS  
127517 10" x 14" SS  
127513 7" x 10" PL  
127516 10" x 14" PL  
127512 7" x 10" AL  
127515 10" x 14" AL



65571 10" x 7" FB  
65570 14" x 10" FB  
85846 5" x 3-1/2" SS  
85847 7" x 5" SS  
85848 10" x 7" SS  
85849 14" x 10" SS  
22909 10" x 7" PL  
22910 14" x 10" PL  
42432 10" x 7" AL  
42433 14" x 10" AL



60176 2-1/4" x 4-1/2" SSV



127526 7" x 10" SS  
127529 10" x 14" SS  
127525 7" x 10" PL  
127528 10" x 14" PL  
127524 7" x 10" AL  
127527 10" x 14" AL



127520 7" x 10" SS  
127523 10" x 14" SS  
127519 7" x 10" PL  
127522 10" x 14" PL  
127518 7" x 10" AL  
127521 10" x 14" AL



60178 2-1/4" x 4-1/2" SSV



60173 2-1/4" x 4-1/2" SSV



60172 2-1/4" x 4-1/2" SSV



127532 7" x 10" SS  
127535 10" x 14" SS  
127531 7" x 10" PL  
127534 10" x 14" PL  
127530 7" x 10" AL  
127533 10" x 14" AL



122776 10" x 7" FB  
65516 14" x 10" FB  
85890 5" x 3-1/2" SS  
85891 7" x 5" SS  
122628 10" x 7" SS  
85893 14" x 10" SS  
22931 10" x 7" PL  
22932 14" x 10" PL  
42454 10" x 7" AL  
42455 14" x 10" AL

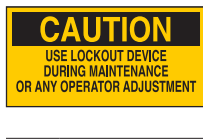

60170 2-1/4" x 4-1/2" SSV



65575 10" x 7" FB  
65576 14" x 10" FB  
85911 5" x 3-1/2" SS  
85912 7" x 5" SS  
85913 10" x 7" SS  
22943 10" x 7" PL



66004 5" x 3-1/2" MAG  
66005 7" x 5" MAG



127544 7" x 10" SS  
127547 10" x 14" SS  
127543 7" x 10" PL  
127546 10" x 14" PL  
127542 7" x 10" AL  
127545 10" x 14" AL



66006 5" x 3-1/2" MAG  
66007 7" x 5" MAG



66008 5" x 3-1/2" MAG  
66009 7" x 5" MAG  
50269 7" x 10" PL

## Lockout Tagout Signs (Continued)



50269 7' x 10' PL



127550 7' x 10' SS  
127553 10' x 14' SS  
127549 7' x 10' PL  
127552 10' x 14' PL  
127548 7' x 10' AL  
127551 10' x 14' AL

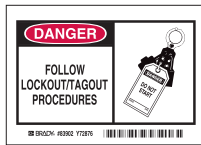

62436 7' x 10' FB  
83902 3-1/2' x 5' SS  
83681 7' x 10' SS  
21729 7' x 10' PL  
26549 10' x 14' PL  
46647 7' x 10' AL  
46691 10' x 14' AL



127556 7' x 10' SS  
127559 10' x 14' SS  
127555 7' x 10' PL  
127558 10' x 14' PL  
127554 7' x 10' AL  
127557 10' x 14' AL



127562 7' x 10' SS  
127565 10' x 14' SS  
127561 7' x 10' PL  
127564 10' x 14' PL  
127560 7' x 10' AL  
127563 10' x 14' AL



127574 7' x 10' SS  
127577 10' x 14' SS  
127573 7' x 10' PL  
127576 10' x 14' PL  
127572 7' x 10' AL  
127575 10' x 14' AL



123637 7' x 10' SS  
123640 10' x 14' SS  
123636 7' x 10' PL  
123639 10' x 14' PL  
123635 7' x 10' AL  
123638 10' x 14' AL



127538 7' x 10' SS  
127541 10' x 14' SS  
127537 7' x 10' PL  
127540 10' x 14' PL  
127536 7' x 10' AL  
127539 10' x 14' AL



127568 7' x 10' SS  
127571 10' x 14' SS  
127567 7' x 10' PL  
127570 10' x 14' PL  
127566 7' x 10' AL  
127569 10' x 14' AL

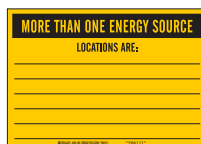

60180 7' x 10' SSV

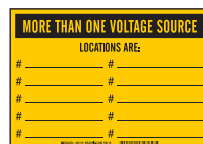

60179 7' x 10' SSV



122799 7' x 10' FB  
122778 14' x 10' FB  
65511 20' x 14' FB  
122638 7' x 10' SS  
122629 14' x 10' SS  
122506 7' x 10' PL  
25922 14' x 10' PL  
122395 7' x 10' AL  
43519 14' x 10' AL



127580 7' x 10' SS  
127583 10' x 14' SS  
127579 7' x 10' PL  
127582 10' x 14' PL  
127578 7' x 10' AL  
127581 10' x 14' AL



127592 7' x 10' SS  
127595 10' x 14' SS  
127591 7' x 10' PL  
127594 10' x 14' PL  
127590 7' x 10' AL  
127593 10' x 14' AL



60177 2-1/4' x 4-1/2' SSV



127586 7' x 10' SS  
127589 10' x 14' SS  
127585 7' x 10' PL  
127588 10' x 14' PL  
127584 7' x 10' AL  
127587 10' x 14' AL



60174 2-1/4' x 4-1/2' SSV



65682 10' x 7' FB  
89093 7' x 5' SS  
25876 10' x 7' PL  
25877 14' x 10' PL  
43454 14' x 10' AL



88302 2-1/4' x 4-1/2' SS



88303 2-1/4' x 4-1/2' SS



88304 2-1/4' x 4-1/2' SS  
122667 7' x 10' SS  
122590 10' x 14' SS



88316 2-1/4' x 4-1/2' SS



60167 2-1/4' x 4-1/2' SSV



88320 2-1/4' x 4-1/2' SS

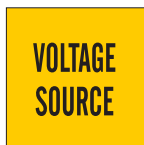

60161 2' x 2' SSV



# Machine and Operational Signs

BradyID.com/s34

## Machine and Operational Signs

Brady machine safety signs communicate warning messages about the potential dangers of operating machinery and equipment in your facility. These signs remind employees about safety, risks, proper operating instructions, and other restrictions.

### Popular Sign Materials

- FB** - Premium Fiberglass (B-120)
  - SS** - Self-Sticking Polyester (B-302)
  - BGSS** - BradyGlo™ Self-Sticking Polyester (B-324)
  - BGPL** - BradyGlo™ Plastic (B-347)
  - PL** - Plastic (B-401)
  - AL** - Aluminum (B-555)
- View all sign materials on page 25.*

### Can't find your sign?

*Use the Sign Legend Index on page 498 or take advantage of our custom sign options.*

Safety Signs



85757	10" x 14"	SS
22861	7" x 10"	PL
22862	10" x 14"	PL
42385	10" x 14"	AL



127598	7" x 10"	SS
127601	10" x 14"	SS
127597	7" x 10"	PL
127600	10" x 14"	PL
127596	7" x 10"	AL
127599	10" x 14"	AL



124276	7" x 10"	SS
124279	10" x 14"	SS
124275	7" x 10"	PL
124278	10" x 14"	PL
124274	7" x 10"	AL
124277	10" x 14"	AL



124219	7" x 10"	SS
124222	10" x 14"	SS
124218	7" x 10"	PL
124221	10" x 14"	PL
124217	7" x 10"	AL
124220	10" x 14"	AL



127604	7" x 10"	SS
127607	10" x 14"	SS
127603	7" x 10"	PL
127606	10" x 14"	PL
127602	7" x 10"	AL
127605	10" x 14"	AL



127610	7" x 10"	SS
127613	10" x 14"	SS
127609	7" x 10"	PL
127612	10" x 14"	PL
127608	7" x 10"	AL
127611	10" x 14"	AL



85777	7" x 10"	SS
85778	10" x 14"	SS
22863	7" x 10"	PL
22864	10" x 14"	PL
42386	7" x 10"	AL
42387	10" x 14"	AL



69068	10" x 14"	FB
85779	7" x 10"	SS
85780	10" x 14"	SS
22865	7" x 10"	PL
42388	7" x 10"	AL
42389	10" x 14"	AL



85781	7" x 10"	SS
22867	7" x 10"	PL
42391	10" x 14"	AL



69090	10" x 14"	FB
85783	7" x 10"	SS
22870	10" x 14"	PL



127634	7" x 10"	SS
127637	10" x 14"	SS
127633	7" x 10"	PL
127636	10" x 14"	PL
127632	7" x 10"	AL
127635	10" x 14"	AL



22873	7" x 10"	PL
22874	10" x 14"	PL
42396	7" x 10"	AL
42397	10" x 14"	AL



70278	10" x 14"	FB
85791	7" x 10"	SS
85792	10" x 14"	SS
22875	7" x 10"	PL
22876	10" x 14"	PL
42398	7" x 10"	AL



47058	7" x 10"	FB
85793	7" x 10"	SS
22877	7" x 10"	PL
22878	10" x 14"	PL
42400	7" x 10"	AL
42401	10" x 14"	AL



47060	7" x 10"	FB
122716	10" x 14"	FB
87791	3-1/2" x 5"	SS
85797	7" x 10"	SS
122576	10" x 14"	SS
22879	7" x 10"	PL
22880	10" x 14"	PL
42402	7" x 10"	AL



70280	10" x 14"	FB
85799	7" x 10"	SS
42404	7" x 10"	AL



127628	7" x 10"	SS
127631	10" x 14"	SS
127627	7" x 10"	PL
127630	10" x 14"	PL
127626	7" x 10"	AL
127629	10" x 14"	AL



127616	7" x 10"	SS
127619	10" x 14"	SS
127615	7" x 10"	PL
127618	10" x 14"	PL
127614	7" x 10"	AL
127617	10" x 14"	AL



127622	7" x 10"	SS
127625	10" x 14"	SS
127621	7" x 10"	PL
127624	10" x 14"	PL
127620	7" x 10"	AL
127623	10" x 14"	AL



22891	7" x 10"	PL
22892	10" x 14"	PL
42414	7" x 10"	AL
42415	10" x 14"	AL



70322	10" x 14"	FB
85813	7" x 10"	SS
42416	7" x 10"	AL



132082	7" x 10"	FB
132083	10" x 14"	FB
132080	7" x 10"	SS
132081	10" x 14"	SS
132078	7" x 10"	PL
132079	10" x 14"	PL
132076	7" x 10"	AL
132077	10" x 14"	AL



85819	7" x 10"	SS
85820	10" x 14"	SS
22895	7" x 10"	PL
22896	10" x 14"	PL
42418	7" x 10"	AL
42419	10" x 14"	AL



127640	7" x 10"	SS
127643	10" x 14"	SS
127639	7" x 10"	PL
127642	10" x 14"	PL
127638	7" x 10"	AL
127641	10" x 14"	AL



# Machine and Operational Signs

BradyID.com/s34

## Machine and Operational Signs (Continued)



122874	7" x 10"	FB
122735	10" x 14"	FB
122666	7" x 10"	SS
122589	10" x 14"	SS
122539	7" x 10"	PL
122484	10" x 14"	PL
122430	7" x 10"	AL
43500	10" x 14"	AL



69031	10" x 14"	FB
85828	10" x 14"	SS
22897	7" x 10"	PL
22898	10" x 14"	PL
42420	7" x 10"	AL
42421	10" x 14"	AL



124243	7" x 10"	SS
124246	10" x 14"	SS
124242	7" x 10"	PL
124245	10" x 14"	PL
124241	7" x 10"	AL
124244	10" x 14"	AL



129086	10" x 7"	SS
129089	14" x 10"	SS
129085	10" x 7"	PL
129088	14" x 10"	PL
129084	10" x 7"	AL
129087	14" x 10"	AL



127646	7" x 10"	SS
127649	10" x 14"	SS
127645	7" x 10"	PL
127648	10" x 14"	PL
127644	7" x 10"	AL
127647	10" x 14"	AL



85831	7" x 10"	SS
22901	7" x 10"	PL
22902	10" x 14"	PL
42424	7" x 10"	AL
42425	10" x 14"	AL



127652	7" x 10"	SS
127655	10" x 14"	SS
127651	7" x 10"	PL
127654	10" x 14"	PL
127650	7" x 10"	AL
127653	10" x 14"	AL



70406	10" x 14"	FB
85838	7" x 10"	SS
22903	7" x 10"	PL
42427	10" x 14"	AL



70409	10" x 14"	FB
85844	7" x 10"	SS
22907	7" x 10"	PL
42430	7" x 10"	AL
42431	10" x 14"	AL



85854	7" x 10"	SS
85855	10" x 14"	SS
22913	7" x 10"	PL
22914	10" x 14"	PL
42436	7" x 10"	AL
42437	10" x 14"	AL



134179	7" x 10"	AL
134180	10" x 14"	AL
134181	18" x 24"	AL
134182	24" x 36"	AL



75126	10" x 14"	FB
85856	7" x 10"	SS
85857	10" x 14"	SS
22915	7" x 10"	PL
22916	10" x 14"	PL
42438	7" x 10"	AL
42439	10" x 14"	AL



122843	7" x 10"	FB
74270	10" x 14"	FB
87790	3-1/2" x 5"	SS
85858	7" x 10"	SS
85859	10" x 14"	SS
22917	7" x 10"	PL
22918	10" x 14"	PL
42440	7" x 10"	AL
42441	10" x 14"	AL



132090	7" x 10"	FB
132091	10" x 14"	FB
132088	7" x 10"	SS
132089	10" x 14"	SS
132086	7" x 10"	PL
132087	10" x 14"	PL
132084	7" x 10"	AL
132085	10" x 14"	AL



85860	7" x 10"	SS
85861	10" x 14"	SS
22919	7" x 10"	PL
22920	10" x 14"	PL
42442	7" x 10"	AL
42443	10" x 14"	AL



127658	7" x 10"	SS
127661	10" x 14"	SS
127657	7" x 10"	PL
127660	10" x 14"	PL
127656	7" x 10"	AL
127659	10" x 14"	AL



127664	7" x 10"	SS
127667	10" x 14"	SS
127663	7" x 10"	PL
127666	10" x 14"	PL
127662	7" x 10"	AL
127665	10" x 14"	AL



69404	10" x 14"	FB
85083	7" x 10"	SS
85084	10" x 14"	SS
25596	7" x 10"	PL
25597	10" x 14"	PL
43173	7" x 10"	AL
43174	10" x 14"	AL



129056	7" x 10"	SS
129059	10" x 14"	SS
129055	7" x 10"	PL
129058	10" x 14"	PL
129054	7" x 10"	AL
129057	10" x 14"	AL



85866	7" x 10"	SS
85867	10" x 14"	SS
22921	7" x 10"	PL
22922	10" x 14"	PL
42444	7" x 10"	AL
42445	10" x 14"	AL



129062	7" x 10"	SS
129065	10" x 14"	SS
129061	7" x 10"	PL
129064	10" x 14"	PL
129060	7" x 10"	AL
129063	10" x 14"	AL



73444	10" x 14"	FB
84708	7" x 10"	SS
22517	7" x 10"	PL
22518	10" x 14"	PL
41081	7" x 10"	AL
41082	10" x 14"	AL



127670	7" x 10"	SS
127673	10" x 14"	SS
127669	7" x 10"	PL
127672	10" x 14"	PL
127668	7" x 10"	AL
127671	10" x 14"	AL



122845	7" x 10"	FB
70470	10" x 14"	FB
85870	7" x 10"	SS
85871	10" x 14"	SS
22923	7" x 10"	PL
22924	10" x 14"	PL
122409	7" x 10"	AL
42447	10" x 14"	AL



# Machine and Operational Signs

BradyID.com/s34

## Machine and Operational Signs (Continued)

Safety Signs



127676	7" x 10"	SS
127679	10" x 14"	SS
127675	7" x 10"	PL
127678	10" x 14"	PL
127674	7" x 10"	AL
127677	10" x 14"	AL



127682	7" x 10"	SS
127685	10" x 14"	SS
127681	7" x 10"	PL
127684	10" x 14"	PL
127680	7" x 10"	AL
127683	10" x 14"	AL



127688	7" x 10"	SS
127691	10" x 14"	SS
127687	7" x 10"	PL
127690	10" x 14"	PL
127686	7" x 10"	AL
127689	10" x 14"	AL



70527	7" x 10"	FB
70528	10" x 14"	FB
87783	3-1/2" x 5"	SS
85085	7" x 10"	SS
85086	10" x 14"	SS
25598	7" x 10"	PL
25599	10" x 14"	PL
43175	7" x 10"	AL
43176	10" x 14"	AL

**Popular Sign Materials**

**FB** - Premium Fiberglass (B-120)  
**SS** - Self-Sticking Polyester (B-302)  
**BGSS** - BradyGlo™ Self-Sticking Polyester (B-324)  
**BGPL** - BradyGlo™ Plastic (B-347)  
**PL** - Plastic (B-401)  
**AL** - Aluminum (B-555)

*View all sign materials on page 25.*

**Can't find your sign?**  
*Use the Sign Legend Index on page 498 or take advantage of our custom sign options.*



132074	7" x 10"	FB
132075	10" x 14"	FB
132072	7" x 10"	SS
132073	10" x 14"	SS
132070	7" x 10"	PL
132071	10" x 14"	PL
132068	7" x 10"	AL
132069	10" x 14"	AL



129068	7" x 10"	SS
129071	10" x 14"	SS
129067	7" x 10"	PL
129070	10" x 14"	PL
129066	7" x 10"	AL
129069	10" x 14"	AL



47124	10" x 14"	FB
87784	3-1/2" x 5"	SS
85087	7" x 10"	SS
85088	10" x 14"	SS
25600	7" x 10"	PL
25601	10" x 14"	PL
43177	7" x 10"	AL
43178	10" x 14"	AL



70529	7" x 17"	FB
-------	----------	----



132066	7" x 10"	FB
132067	10" x 14"	FB
132064	7" x 10"	SS
132065	10" x 14"	SS
132062	7" x 10"	PL
132063	10" x 14"	PL
132060	7" x 10"	AL
132061	10" x 14"	AL



129074	7" x 10"	SS
129077	10" x 14"	SS
129073	7" x 10"	PL
129076	10" x 14"	PL
129072	7" x 10"	AL
129075	10" x 14"	AL



41083	7" x 10"	AL
-------	----------	----



127694	7" x 10"	SS
127697	10" x 14"	SS
127693	7" x 10"	PL
127696	10" x 14"	PL
127692	7" x 10"	AL
127695	10" x 14"	AL



127700	7" x 10"	SS
127703	10" x 14"	SS
127699	7" x 10"	PL
127702	10" x 14"	PL
127698	7" x 10"	AL
127701	10" x 14"	AL



74350	7" x 10"	FB
85886	7" x 10"	SS
85887	10" x 14"	SS
22929	7" x 10"	PL
22930	10" x 14"	PL
42452	7" x 10"	AL
42453	10" x 14"	AL



85091	7" x 10"	SS
85092	10" x 14"	SS
25604	7" x 10"	PL
25605	10" x 14"	PL
43181	7" x 10"	AL
43182	10" x 14"	AL



127706	7" x 10"	SS
127709	10" x 14"	SS
127705	7" x 10"	PL
127708	10" x 14"	PL
127704	7" x 10"	AL
127707	10" x 14"	AL



85896	7" x 10"	SS
85897	10" x 14"	SS
22933	7" x 10"	PL
42457	10" x 14"	AL



69531	10" x 14"	FB
85898	7" x 10"	SS
22935	7" x 10"	PL
42458	7" x 10"	AL
42459	10" x 14"	AL



74385	10" x 14"	FB
85093	7" x 10"	SS
85094	10" x 14"	SS
25606	7" x 10"	PL
25607	10" x 14"	PL
43183	7" x 10"	AL
43184	10" x 14"	AL



# Machine and Operational Signs

BradyID.com/s34

## Machine and Operational Signs (Continued)



70563	10" x 14"	FB
85900	7" x 10"	SS
85901	10" x 14"	SS
22937	7" x 10"	PL



85902	3-1/2" x 5"	SS
-------	-------------	----



43185	7" x 10"	AL
43186	10" x 14"	AL
74680	7" x 10"	FB
85095	7" x 10"	SS
85096	10" x 14"	SS
25608	7" x 10"	PL
25609	10" x 14"	PL



129092	10" x 7"	SS
129095	14" x 10"	SS
129091	10" x 7"	PL
129094	14" x 10"	PL
129090	10" x 7"	AL
129093	14" x 10"	AL



122848	7" x 10"	FB
122718	10" x 14"	FB
122652	7" x 10"	SS
122577	10" x 14"	SS
122521	7" x 10"	PL
25906	10" x 14"	PL
122411	7" x 10"	AL
43483	10" x 14"	AL



127712	7" x 10"	SS
127715	10" x 14"	SS
127711	7" x 10"	PL
127714	10" x 14"	PL
127710	7" x 10"	AL
127713	10" x 14"	AL



70577	7" x 17"	FB
-------	----------	----



74442	14" x 20"	FB
85903	7" x 10"	SS
85904	10" x 14"	SS
22939	7" x 10"	PL
22940	10" x 14"	PL
42462	7" x 10"	AL
42463	10" x 14"	AL



70579	10" x 14"	FB
85905	7" x 10"	SS
22941	7" x 10"	PL
22942	10" x 14"	PL
42464	7" x 10"	AL
42465	10" x 14"	AL



70580	7" x 17"	FB
25907	10" x 14"	PL
43484	10" x 14"	AL



127718	7" x 10"	SS
127721	10" x 14"	SS
127717	7" x 10"	PL
127720	10" x 14"	PL
127716	7" x 10"	AL
127719	10" x 14"	AL



74455	10" x 14"	FB
87782	3-1/2" x 5"	SS
85097	7" x 10"	SS
85098	10" x 14"	SS
25610	7" x 10"	PL
25611	10" x 14"	PL
43187	7" x 10"	AL
43188	10" x 14"	AL



132098	7" x 10"	FB
132099	10" x 14"	FB
132096	7" x 10"	SS
132097	10" x 14"	SS
132094	7" x 10"	PL
132095	10" x 14"	PL
132092	7" x 10"	AL
132093	10" x 14"	AL



69551	7" x 17"	FB
-------	----------	----



129080	7" x 10"	SS
129083	10" x 14"	SS
129079	7" x 10"	PL
129082	10" x 14"	PL
129078	7" x 10"	AL
129081	10" x 14"	AL



70587	7" x 17"	FB
-------	----------	----



74509	10" x 14"	FB
85099	7" x 10"	SS
85100	10" x 14"	SS
25612	7" x 10"	PL
25613	10" x 14"	PL
43189	7" x 10"	AL
43190	10" x 14"	AL

## Custom Signs

Brady's "Same as Stock" custom sign pricing makes it easy to create signs unique to your facility.

View page 194 for more information.



# Machine and Operational Signs

BradyID.com/s34

## Machine and Operational Signs (Continued)

Safety Signs



127802	7" x 10"	SS
127805	10" x 14"	SS
127801	7" x 10"	PL
127804	10" x 14"	PL
127800	7" x 10"	AL
127803	10" x 14"	AL



73009	10" x 14"	FB
85919	7" x 10"	SS
85920	10" x 14"	SS
22945	7" x 10"	PL
22946	10" x 14"	PL
42468	7" x 10"	AL
42469	10" x 14"	AL



127820	7" x 10"	SS
127823	10" x 14"	SS
127819	7" x 10"	PL
127822	10" x 14"	PL
127818	7" x 10"	AL
127821	10" x 14"	AL



127814	7" x 10"	SS
127817	10" x 14"	SS
127813	7" x 10"	PL
127816	10" x 14"	PL
127812	7" x 10"	AL
127815	10" x 14"	AL

**Popular Sign Materials**

**FB** - Premium Fiberglass (B-120)  
**SS** - Self-Sticking Polyester (B-302)  
**BGSS** - BradyGlo™ Self-Sticking Polyester (B-324)  
**BGPL** - BradyGlo™ Plastic (B-347)  
**PL** - Plastic (B-401)  
**AL** - Aluminum (B-555)

*View all sign materials on page 25.*

**Can't find your sign?**  
*Use the Sign Legend Index on page 498 or take advantage of our custom sign options.*



69046	10" x 14"	FB
85921	7" x 10"	SS
22948	10" x 14"	PL
42471	10" x 14"	AL



73052	14" x 20"	FB
85923	7" x 10"	SS
85924	10" x 14"	SS
22949	7" x 10"	PL
22950	10" x 14"	PL
42472	7" x 10"	AL
42473	10" x 14"	AL



85925	7" x 10"	SS
85926	10" x 14"	SS



73058	10" x 14"	FB
85927	7" x 10"	SS
85928	10" x 14"	SS
22951	7" x 10"	PL
22952	10" x 14"	PL
42474	7" x 10"	AL
42475	10" x 14"	AL



69075	10" x 14"	FB
85101	7" x 10"	SS
85102	10" x 14"	SS
25614	7" x 10"	PL
25615	10" x 14"	PL
43191	7" x 10"	AL
43192	10" x 14"	AL



127808	7" x 10"	SS
127811	10" x 14"	SS
127807	7" x 10"	PL
127810	10" x 14"	PL
127806	7" x 10"	AL
127809	10" x 14"	AL



85942	10" x 14"	SS
22953	7" x 10"	PL
42476	7" x 10"	AL



73086	7" x 10"	FB
22955	7" x 10"	PL
22956	10" x 14"	PL
42478	7" x 10"	AL



69131	7" x 17"	FB
-------	----------	----



127856	7" x 10"	SS
127859	10" x 14"	SS
127855	7" x 10"	PL
127858	10" x 14"	PL
127854	7" x 10"	AL
127857	10" x 14"	AL



127868	7" x 10"	SS
127871	10" x 14"	SS
127867	7" x 10"	PL
127870	10" x 14"	PL
127866	7" x 10"	AL
127869	10" x 14"	AL



127838	7" x 10"	SS
127841	10" x 14"	SS
127837	7" x 10"	PL
127840	10" x 14"	PL
127836	7" x 10"	AL
127839	10" x 14"	AL



69144	10" x 14"	FB
85949	7" x 10"	SS
22957	7" x 10"	PL
22958	10" x 14"	PL
42480	7" x 10"	AL
42481	10" x 14"	AL



127862	7" x 10"	SS
127865	10" x 14"	SS
127861	7" x 10"	PL
127864	10" x 14"	PL
127860	7" x 10"	AL
127863	10" x 14"	AL



22960	10" x 14"	PL
-------	-----------	----



69148	10" x 14"	FB
22961	7" x 10"	PL
22962	10" x 14"	PL
42485	10" x 14"	AL



74111	10" x 14"	FB
85959	7" x 10"	SS
85960	10" x 14"	SS
22963	7" x 10"	PL
22964	10" x 14"	PL
42486	7" x 10"	AL
42487	10" x 14"	AL



127844	7" x 10"	SS
127847	10" x 14"	SS
127843	7" x 10"	PL
127846	10" x 14"	PL
127842	7" x 10"	AL
127845	10" x 14"	AL



# Machine and Operational Signs

## Machine and Operational Signs (Continued)



127832	7" x 10"	SS
127835	10" x 14"	SS
127831	7" x 10"	PL
127834	10" x 14"	PL
127830	7" x 10"	AL
127833	10" x 14"	AL



43497	7" x 10"	AL
-------	----------	----



127850	7" x 10"	SS
127853	10" x 14"	SS
127849	7" x 10"	PL
127852	10" x 14"	PL
127848	7" x 10"	AL
127851	10" x 14"	AL



69170	10" x 14"	FB
85973	7" x 10"	SS
85974	10" x 14"	SS
22968	10" x 14"	PL
42490	7" x 10"	AL
42491	10" x 14"	AL



122824	7" x 10"	FB
74132	10" x 14"	FB
85971	7" x 10"	SS
85972	10" x 14"	SS
22965	7" x 10"	PL
22966	10" x 14"	PL
42488	7" x 10"	AL
42489	10" x 14"	AL



70290	7" x 10"	FB
85975	7" x 10"	SS
22970	10" x 14"	PL
42492	7" x 10"	AL
42493	10" x 14"	AL



85979	7" x 10"	SS
22971	7" x 10"	PL
22972	10" x 14"	PL
42494	7" x 10"	AL
42495	10" x 14"	AL



85119	7" x 10"	SS
85120	10" x 14"	SS
25623	10" x 14"	PL
43200	10" x 14"	AL



85985	7" x 10"	SS
85986	10" x 14"	SS
22973	7" x 10"	PL
22974	10" x 14"	PL
42496	7" x 10"	AL
42497	10" x 14"	AL



69237	10" x 14"	FB
85987	7" x 10"	SS
85988	10" x 14"	SS
22975	7" x 10"	PL
22976	10" x 14"	PL
42498	7" x 10"	AL
42499	10" x 14"	AL



122814	7" x 10"	FB
70340	10" x 14"	FB
85989	7" x 10"	SS
85990	10" x 14"	SS
22977	7" x 10"	PL
22978	10" x 14"	PL
42500	7" x 10"	AL
42501	10" x 14"	AL



70363	10" x 14"	FB
85995	7" x 10"	SS
42502	7" x 10"	AL
42503	10" x 14"	AL



73460	7" x 10"	FB
85997	7" x 10"	SS
85998	10" x 14"	SS
22981	7" x 10"	PL
22982	10" x 14"	PL
42504	7" x 10"	AL
42505	10" x 14"	AL



122840	7" x 10"	FB
74187	10" x 14"	FB
88101	7" x 10"	SS
88102	10" x 14"	SS
22983	7" x 10"	PL
22984	10" x 14"	PL
42506	7" x 10"	AL
42507	10" x 14"	AL



127874	7" x 10"	SS
127877	10" x 14"	SS
127873	7" x 10"	PL
127876	10" x 14"	PL
127872	7" x 10"	AL
127875	10" x 14"	AL



122816	7" x 10"	FB
74609	10" x 14"	FB
87788	3-1/2" x 5"	SS
88107	7" x 10"	SS
88108	10" x 14"	SS
22985	7" x 10"	PL
22986	10" x 14"	PL
42508	7" x 10"	AL
42509	10" x 14"	AL



131877	7" x 10"	FB
131878	10" x 14"	FB
131875	7" x 10"	SS
131876	10" x 14"	SS
131873	7" x 10"	PL
131874	10" x 14"	PL
131871	7" x 10"	AL
131872	10" x 14"	AL



123727	7" x 10"	SS
123730	10" x 14"	SS
123726	7" x 10"	PL
123729	10" x 14"	PL
123725	7" x 10"	AL
123728	10" x 14"	AL



70393	10" x 14"	FB
88109	7" x 10"	SS
22987	7" x 10"	PL
42510	7" x 10"	AL
42511	10" x 14"	AL



69028	7" x 17"	FB
-------	----------	----



127880	7" x 10"	SS
127883	10" x 14"	SS
127879	7" x 10"	PL
127882	10" x 14"	PL
127878	7" x 10"	AL
127881	10" x 14"	AL



69317	10" x 14"	FB
88115	7" x 10"	SS
88116	10" x 14"	SS
22989	7" x 10"	PL



88117	7" x 10"	SS
42514	7" x 10"	AL
42515	10" x 14"	AL



127886	7" x 10"	SS
127889	10" x 14"	SS
127885	7" x 10"	PL
127888	10" x 14"	PL
127884	7" x 10"	AL
127887	10" x 14"	AL



74226	7" x 10"	FB
88119	7" x 10"	SS
88120	10" x 14"	SS
22993	7" x 10"	PL
22994	10" x 14"	PL
42516	7" x 10"	AL



127892	7" x 10"	SS
127895	10" x 14"	SS
127891	7" x 10"	PL
127894	10" x 14"	PL
127890	7" x 10"	AL
127893	10" x 14"	AL



88123	7" x 10"	SS
88124	10" x 14"	SS
22995	7" x 10"	PL
22996	10" x 14"	PL
42518	7" x 10"	AL
42519	10" x 14"	AL



22998	10" x 14"	PL
42521	10" x 14"	AL



# Machine and Operational Signs

BradyID.com/s34

## Machine and Operational Signs (Continued)

Safety Signs



69344	10" x 14"	FB
88127	7" x 10"	SS
88128	10" x 14"	SS
23000	10" x 14"	PL
42522	7" x 10"	AL
42523	10" x 14"	AL



123745	7" x 10"	SS
123748	10" x 14"	SS
123744	7" x 10"	PL
123747	10" x 14"	PL
123743	7" x 10"	AL
123746	10" x 14"	AL



74264	10" x 14"	FB
88131	7" x 10"	SS
88132	10" x 14"	SS
23001	7" x 10"	PL
23002	10" x 14"	PL
42524	7" x 10"	AL
42525	10" x 14"	AL



25911	10" x 14"	PL
43488	10" x 14"	AL

**Popular Sign Materials**

**FB** - Premium Fiberglass (B-120)  
**SS** - Self-Sticking Polyester (B-302)  
**BGSS** - BradyGlo™ Self-Sticking Polyester (B-324)  
**BGPL** - BradyGlo™ Plastic (B-347)  
**PL** - Plastic (B-401)  
**AL** - Aluminum (B-555)

*View all sign materials on page 25.*

**Can't find your sign?**  
*Use the Sign Legend Index on page 498 or take advantage of our custom sign options.*



23003	7" x 10"	PL
23004	10" x 14"	PL
42526	7" x 10"	AL
42527	10" x 14"	AL



73415	14" x 20"	FB
88135	7" x 10"	SS
23005	7" x 10"	PL
23006	10" x 14"	PL
42528	7" x 10"	AL
42529	10" x 14"	AL



127898	7" x 10"	SS
127901	10" x 14"	SS
127897	7" x 10"	PL
127900	10" x 14"	PL
127896	7" x 10"	AL
127899	10" x 14"	AL



70422	10" x 14"	FB
88137	7" x 10"	SS
88138	10" x 14"	SS
23007	7" x 10"	PL
23008	10" x 14"	PL
42530	7" x 10"	AL
42531	10" x 14"	AL



88141	7" x 10"	SS
88142	10" x 14"	SS
23009	7" x 10"	PL
23010	10" x 14"	PL
42533	10" x 14"	AL



122827	7" x 10"	FB
47022	10" x 14"	FB
87793	3-1/2" x 5"	SS
88143	7" x 10"	SS
88144	10" x 14"	SS
23011	7" x 10"	PL
23012	10" x 14"	PL
42534	7" x 10"	AL
42535	10" x 14"	AL



71118	20" x 14"	FB
88146	14" x 10"	SS
23013	10" x 7"	PL
23014	14" x 10"	PL
42536	10" x 7"	AL



71120	20" x 14"	FB
42539	14" x 10"	AL
23015	10" x 7"	PL
23016	14" x 10"	PL



127904	7" x 10"	SS
127907	10" x 14"	SS
127903	7" x 10"	PL
127906	10" x 14"	PL
127902	7" x 10"	AL
127905	10" x 14"	AL



88152	7" x 10"	SS
88153	10" x 14"	SS
23019	7" x 10"	PL
23020	10" x 14"	PL
42542	7" x 10"	AL
42543	10" x 14"	AL



127910	7" x 10"	SS
127913	10" x 14"	SS
127909	7" x 10"	PL
127912	10" x 14"	PL
127908	7" x 10"	AL
127911	10" x 14"	AL



88158	7" x 10"	SS
23021	7" x 10"	PL
23022	10" x 14"	PL



70437	7" x 10"	FB
88155	10" x 14"	SS
25815	10" x 14"	PL
43392	10" x 14"	AL



70438	14" x 20"	FB
25816	10" x 14"	PL



127916	7" x 10"	SS
127919	10" x 14"	SS
127915	7" x 10"	PL
127918	10" x 14"	PL
127914	7" x 10"	AL
127917	10" x 14"	AL



123739	7" x 10"	SS
123742	10" x 14"	SS
123738	7" x 10"	PL
123741	10" x 14"	PL
123737	7" x 10"	AL
123740	10" x 14"	AL



74299	7" x 10"	FB
85115	7" x 10"	SS
85116	10" x 14"	SS
25618	7" x 10"	PL
25619	10" x 14"	PL
43195	7" x 10"	AL
43196	10" x 14"	AL



74305	10" x 14"	FB
85117	7" x 10"	SS
85118	10" x 14"	SS
25620	7" x 10"	PL
25621	10" x 14"	PL
43197	7" x 10"	AL
43198	10" x 14"	AL

# Machine and Operational Signs

BradyID.com/s34

## Machine and Operational Signs (Continued)



69413	10" x 14"	FB
25625	10" x 14"	PL
43202	10" x 14"	AL



70467	7" x 10"	FB
70468	10" x 14"	FB
88160	7" x 10"	SS
88161	10" x 14"	SS
23023	7" x 10"	PL
23024	10" x 14"	PL
42546	7" x 10"	AL
42547	10" x 14"	AL



69417	10" x 14"	FB
88162	7" x 10"	SS
88163	10" x 14"	SS
23025	7" x 10"	PL
23026	10" x 14"	PL
42548	7" x 10"	AL
42549	10" x 14"	AL



88164	7" x 10"	SS
88165	10" x 14"	SS
23027	7" x 10"	PL
23028	10" x 14"	PL
42550	7" x 10"	AL
42551	10" x 14"	AL



127826	7" x 10"	SS
127829	10" x 14"	SS
127825	7" x 10"	PL
127828	10" x 14"	PL
127824	7" x 10"	AL
127827	10" x 14"	AL



127922	7" x 10"	SS
127925	10" x 14"	SS
127921	7" x 10"	PL
127924	10" x 14"	PL
127920	7" x 10"	AL
127923	10" x 14"	AL



122882	7" x 10"	FB
122743	10" x 14"	FB
122678	7" x 10"	SS
122601	10" x 14"	SS
122547	7" x 10"	PL
25913	10" x 14"	PL
122438	7" x 10"	AL
43490	10" x 14"	AL



127928	7" x 10"	SS
127931	10" x 14"	SS
127927	7" x 10"	PL
127930	10" x 14"	PL
127926	7" x 10"	AL
127929	10" x 14"	AL



69475	10" x 14"	FB
23029	7" x 10"	PL
23030	10" x 14"	PL



87669	7" x 10"	FB
87670	10" x 14"	FB
59506	7" x 10"	SS
21335	10" x 14"	SS
59507	7" x 10"	PL
26923	10" x 14"	PL
59508	7" x 10"	AL
21338	10" x 14"	AL



47159	7" x 10"	FB
88172	3-1/2" x 5"	SS
88173	7" x 10"	SS
88174	10" x 14"	SS
23031	7" x 10"	PL
23032	10" x 14"	PL
42554	7" x 10"	AL
42555	10" x 14"	AL



69504	7" x 17"	FB
-------	----------	----



60576	10" x 14"	SS
60538	10" x 14"	PL
60509	10" x 14"	AL



88175	7" x 10"	SS
88176	10" x 14"	SS
23033	7" x 10"	PL
23034	10" x 14"	PL
42556	7" x 10"	AL
42557	10" x 14"	AL



60575	10" x 14"	SS
60537	10" x 14"	PL
60508	10" x 14"	AL



69510	14" x 20"	FB
88182	10" x 14"	SS
23035	7" x 10"	PL
23036	10" x 14"	PL
42559	10" x 14"	AL



70547	7" x 10"	FB
88183	7" x 10"	SS
88184	10" x 14"	SS
23037	7" x 10"	PL
23038	10" x 14"	PL
42560	7" x 10"	AL



127934	7" x 10"	SS
127937	10" x 14"	SS
127933	7" x 10"	PL
127936	10" x 14"	PL
127932	7" x 10"	AL
127935	10" x 14"	AL



47160	7" x 10"	FB
47192	10" x 14"	FB
87792	3-1/2" x 5"	SS
88185	7" x 10"	SS
88186	10" x 14"	SS
23039	7" x 10"	PL
23040	10" x 14"	PL
42562	7" x 10"	AL
42563	10" x 14"	AL



123685	7" x 10"	SS
123688	10" x 14"	SS
123684	7" x 10"	PL
123687	10" x 14"	PL
123683	7" x 10"	AL
123686	10" x 14"	AL



131869	7" x 10"	FB
131870	10" x 14"	FB
131867	7" x 10"	SS
131868	10" x 14"	SS
131865	7" x 10"	PL
131866	10" x 14"	PL
131863	7" x 10"	AL
131864	10" x 14"	AL



# Machine and Operational Signs

BradyID.com/s34

## Machine and Operational Signs (Continued)

Safety Signs



69540	10" x 14"	FB
88187	7" x 10"	SS
88188	10" x 14"	SS
23041	7" x 10"	PL
42564	7" x 10"	AL



69541	10" x 14"	FB
88189	7" x 10"	SS
23043	7" x 10"	PL
42566	7" x 10"	AL
42567	10" x 14"	AL



47161	7" x 10"	FB
88191	7" x 10"	SS
88192	10" x 14"	SS
23045	7" x 10"	PL
23046	10" x 14"	PL
42568	7" x 10"	AL
42569	10" x 14"	AL



127940	7" x 10"	SS
127943	10" x 14"	SS
127939	7" x 10"	PL
127942	10" x 14"	PL
127938	7" x 10"	AL
127941	10" x 14"	AL

**Popular Sign Materials**

- FB - Premium Fiberglass (B-120)
- SS - Self-Sticking Polyester (B-302)
- BGSS - BradyGlo™ Self-Sticking Polyester (B-324)
- BGPL - BradyGlo™ Plastic (B-347)
- PL - Plastic (B-401)
- AL - Aluminum (B-555)

View all sign materials on page 25.

**Can't find your sign?**  
Use the Sign Legend Index on page 498 or take advantage of our custom sign options.



47162	7" x 10"	FB
75928	14" x 20"	FB
88193	7" x 10"	SS
88194	10" x 14"	SS
23047	7" x 10"	PL
23048	10" x 14"	PL
42570	7" x 10"	AL
42571	10" x 14"	AL



128792	7" x 10"	SS
128795	10" x 14"	SS
128791	7" x 10"	PL
128794	10" x 14"	PL
128790	7" x 10"	AL
128793	10" x 14"	AL



129110	7" x 10"	SS
129113	10" x 14"	SS
129109	7" x 10"	PL
129112	10" x 14"	PL
129108	7" x 10"	AL
129111	10" x 14"	AL



128402	7" x 10"	SS
128405	10" x 14"	SS
128401	7" x 10"	PL
128404	10" x 14"	PL
128400	7" x 10"	AL
128403	10" x 14"	AL



128396	7" x 10"	SS
128399	10" x 14"	SS
128395	7" x 10"	PL
128398	10" x 14"	PL
128394	7" x 10"	AL
128397	10" x 14"	AL



88199	7" x 10"	SS
23051	7" x 10"	PL
23052	10" x 14"	PL



127724	7" x 10"	SS
127727	10" x 14"	SS
127723	7" x 10"	PL
127726	10" x 14"	PL
127722	7" x 10"	AL
127725	10" x 14"	AL



69162	10" x 14"	FB
88205	7" x 10"	SS
88206	10" x 14"	SS
23054	10" x 14"	PL
42576	7" x 10"	AL
42577	10" x 14"	AL



127730	7" x 10"	SS
127733	10" x 14"	SS
127729	7" x 10"	PL
127732	10" x 14"	PL
127728	7" x 10"	AL
127731	10" x 14"	AL



128408	7" x 10"	SS
128411	10" x 14"	SS
128407	7" x 10"	PL
128410	10" x 14"	PL
128406	7" x 10"	AL
128409	10" x 14"	AL



69196	10" x 14"	FB
88208	10" x 14"	SS
23055	7" x 10"	PL
23056	10" x 14"	PL
42578	7" x 10"	AL
42579	10" x 14"	AL



88209	10" x 7"	SS
23057	10" x 7"	PL
23058	14" x 10"	PL



127736	7" x 10"	SS
127739	10" x 14"	SS
127735	7" x 10"	PL
127738	10" x 14"	PL
127734	7" x 10"	AL
127737	10" x 14"	AL



123565	7" x 10"	SS
123568	10" x 14"	SS
123564	7" x 10"	PL
123567	10" x 14"	PL
123563	7" x 10"	AL
123566	10" x 14"	AL



69350	7" x 10"	FB
88215	7" x 10"	SS
88216	10" x 14"	SS
23059	7" x 10"	PL
23060	10" x 14"	PL
42582	7" x 10"	AL
42583	10" x 14"	AL



View page 194 to create custom signs such as this for your facility.



# Machine and Operational Signs

BradyID.com/s34

## Machine and Operational Signs (Continued)

Safety Signs



88217	7" x 10"	SS
88218	10" x 14"	SS
23061	7" x 10"	PL
23062	10" x 14"	PL
42584	7" x 10"	AL
42585	10" x 14"	AL



70446	7" x 17"	FB
-------	----------	----



70448	7" x 17"	FB
-------	----------	----



129116	7" x 10"	SS
129119	10" x 14"	SS
129115	7" x 10"	PL
129118	10" x 14"	PL
129114	7" x 10"	AL
129117	10" x 14"	AL



70546	10" x 14"	FB
88221	7" x 10"	SS
23063	7" x 10"	PL
23064	10" x 14"	PL
42587	10" x 14"	AL



129122	7" x 10"	SS
129125	10" x 14"	SS
129121	7" x 10"	PL
129124	10" x 14"	PL
129120	7" x 10"	AL
129123	10" x 14"	AL



73450	7" x 10"	FB
88225	7" x 10"	SS
88226	10" x 14"	SS
23065	7" x 10"	PL
23066	10" x 14"	PL
42588	7" x 10"	AL
42589	10" x 14"	AL



127742	7" x 10"	SS
127745	10" x 14"	SS
127741	7" x 10"	PL
127744	10" x 14"	PL
127740	7" x 10"	AL
127743	10" x 14"	AL



127748	7" x 10"	SS
127751	10" x 14"	SS
127747	7" x 10"	PL
127750	10" x 14"	PL
127746	7" x 10"	AL
127749	10" x 14"	AL



69149	10" x 14"	FB
88231	7" x 10"	SS
23069	7" x 10"	PL
23070	10" x 14"	PL
42592	7" x 10"	AL



88234	10" x 14"	SS
23071	7" x 10"	PL
42594	7" x 10"	AL
42595	10" x 14"	AL



127754	7" x 10"	SS
127757	10" x 14"	SS
127753	7" x 10"	PL
127756	10" x 14"	PL
127752	7" x 10"	AL
127755	10" x 14"	AL



127760	7" x 10"	SS
127763	10" x 14"	SS
127759	7" x 10"	PL
127762	10" x 14"	PL
127758	7" x 10"	AL
127761	10" x 14"	AL



85133	7" x 10"	SS
85134	10" x 14"	SS
25630	7" x 10"	PL
25631	10" x 14"	PL
43208	10" x 14"	AL



88237	7" x 10"	SS
88238	10" x 14"	SS
23074	10" x 14"	PL



128444	7" x 10"	SS
128447	10" x 14"	SS
128443	7" x 10"	PL
128446	10" x 14"	PL
128442	7" x 10"	AL
128445	10" x 14"	AL



85135	7" x 10"	SS
85136	10" x 14"	SS
25632	7" x 10"	PL
25633	10" x 14"	PL
43209	7" x 10"	AL
43210	10" x 14"	AL



129128	7" x 10"	SS
129131	10" x 14"	SS
129127	7" x 10"	PL
129130	10" x 14"	PL
129126	7" x 10"	AL
129129	10" x 14"	AL



69561	10" x 14"	FB
88243	7" x 10"	SS
88244	10" x 14"	SS
23077	7" x 10"	PL
23078	10" x 14"	PL
42600	7" x 10"	AL
42601	10" x 14"	AL



69577	10" x 14"	FB
88245	7" x 10"	SS
88246	10" x 14"	SS
23079	7" x 10"	PL
25026	10" x 14"	PL
42602	7" x 10"	AL
42603	10" x 14"	AL



69576	10" x 14"	FB
88247	7" x 10"	SS
88248	10" x 14"	SS
25027	7" x 10"	PL
25028	10" x 14"	PL
42604	7" x 10"	AL
42605	10" x 14"	AL



127766	7" x 10"	SS
127769	10" x 14"	SS
127765	7" x 10"	PL
127768	10" x 14"	PL
127764	7" x 10"	AL
127767	10" x 14"	AL



127772	7" x 10"	SS
127775	10" x 14"	SS
127771	7" x 10"	PL
127774	10" x 14"	PL
127770	7" x 10"	AL
127773	10" x 14"	AL



69588	10" x 14"	FB
88251	7" x 10"	SS
88252	10" x 14"	SS
25029	7" x 10"	PL
25030	10" x 14"	PL
42606	7" x 10"	AL
42607	10" x 14"	AL



69590	10" x 14"	FB
88253	7" x 10"	SS
88254	10" x 14"	SS
25031	7" x 10"	PL
25032	10" x 14"	PL
42608	7" x 10"	AL
42609	10" x 14"	AL



69594	10" x 14"	FB
88255	7" x 10"	SS
88256	10" x 14"	SS
25033	7" x 10"	PL
25034	10" x 14"	PL
42610	7" x 10"	AL
42611	10" x 14"	AL



127778	7" x 10"	SS
127781	10" x 14"	SS
127777	7" x 10"	PL
127780	10" x 14"	PL
127776	7" x 10"	AL
127779	10" x 14"	AL



69595	10" x 14"	FB
88257	7" x 10"	SS
88258	10" x 14"	SS
25035	7" x 10"	PL
42612	7" x 10"	AL
42613	10" x 14"	AL



69596	10" x 14"	FB
88259	7" x 10"	SS
88260	10" x 14"	SS
25037	7" x 10"	PL
25038	10" x 14"	PL
42614	7" x 10"	AL
42615	10" x 14"	AL



127784	7" x 10"	SS
127787	10" x 14"	SS
127783	7" x 10"	PL
127786	10" x 14"	PL
127782	7" x 10"	AL
127785	10" x 14"	AL



# Machine and Operational Signs

BradyID.com/s34

## Machine and Operational Signs (Continued)

Safety Signs



127790	7" x 10"	SS
127793	10" x 14"	SS
127789	7" x 10"	PL
127792	10" x 14"	PL
127788	7" x 10"	AL
127791	10" x 14"	AL



129140	7" x 10"	SS
129143	10" x 14"	SS
129139	7" x 10"	PL
129142	10" x 14"	PL
129138	7" x 10"	AL
129141	10" x 14"	AL



69608	10" x 14"	FB
85139	7" x 10"	SS
85140	10" x 14"	SS
25634	7" x 10"	PL
25635	10" x 14"	PL
43211	7" x 10"	AL
43212	10" x 14"	AL



69609	10" x 14"	FB
85141	7" x 10"	SS
85142	10" x 14"	SS
25636	7" x 10"	PL
25637	10" x 14"	PL
43213	7" x 10"	AL
43214	10" x 14"	AL

**Popular Sign Materials**

**FB** - Premium Fiberglass (B-120)  
**SS** - Self-Sticking Polyester (B-302)  
**BGSS** - BradyGlo™ Self-Sticking Polyester (B-324)  
**BGPL** - BradyGlo™ Plastic (B-347)  
**PL** - Plastic (B-401)  
**AL** - Aluminum (B-555)

View all sign materials on page 25.

**Can't find your sign?**  
 Use the Sign Legend Index on page 498 or take advantage of our custom sign options.



69611	10" x 14"	FB
88267	7" x 10"	SS
88268	10" x 14"	SS
25039	7" x 10"	PL
25040	10" x 14"	PL
42616	7" x 10"	AL
42617	10" x 14"	AL



69614	10" x 14"	FB
85143	7" x 10"	SS
85144	10" x 14"	SS
25638	7" x 10"	PL
25639	10" x 14"	PL
43215	7" x 10"	AL
43216	10" x 14"	AL



127796	7" x 10"	SS
127799	10" x 14"	SS
127795	7" x 10"	PL
127798	10" x 14"	PL
127794	7" x 10"	AL
127797	10" x 14"	AL



123953	10" x 7"	SS
123958	14" x 10"	SS
123952	10" x 7"	PL
123955	14" x 10"	PL
123951	10" x 7"	AL
123954	14" x 10"	AL



88275	7" x 10"	SS
88276	10" x 14"	SS
69791	10" x 14"	FB
25041	7" x 10"	PL
42618	7" x 10"	AL



128216	7" x 10"	SS
128219	10" x 14"	SS
128215	7" x 10"	PL
128218	10" x 14"	PL
128214	7" x 10"	AL
128217	10" x 14"	AL



128342	7" x 10"	SS
128345	10" x 14"	SS
128341	7" x 10"	PL
128344	10" x 14"	PL
128340	7" x 10"	AL
128343	10" x 14"	AL



69080	10" x 10"	FB
88494	10" x 10"	SS
42737	10" x 14"	AL



88281	7" x 10"	SS
25043	10" x 14"	PL
42619	7" x 10"	AL
42620	10" x 14"	AL



90524	10" x 7"	BGSS
-------	----------	------



88283	3-1/2" x 10"	SS
-------	--------------	----



88285	3-1/2" x 10"	SS
-------	--------------	----



127952	7" x 10"	SS
127955	10" x 14"	SS
127951	7" x 10"	PL
127954	10" x 14"	PL
127950	7" x 10"	AL
127953	10" x 14"	AL



70315	7" x 10"	FB
88288	7" x 10"	SS
25044	7" x 10"	PL
25045	10" x 14"	PL
42621	7" x 10"	AL
42622	10" x 14"	AL



123853	7" x 10"	SS
123856	10" x 14"	SS
123852	7" x 10"	PL
123855	10" x 14"	PL
123851	7" x 10"	AL
123854	10" x 14"	AL



127958	7" x 10"	SS
127961	10" x 14"	SS
127957	7" x 10"	PL
127960	10" x 14"	PL
127956	7" x 10"	AL
127959	10" x 14"	AL



128360	7" x 10"	SS
128363	10" x 14"	SS
128359	7" x 10"	PL
128362	10" x 14"	PL
128358	7" x 10"	AL
128361	10" x 14"	AL



128348	7" x 10"	SS
128351	10" x 14"	SS
128347	7" x 10"	PL
128350	10" x 14"	PL
128346	7" x 10"	AL
128349	10" x 14"	AL



128354	7" x 10"	SS
128357	10" x 14"	SS
128353	7" x 10"	PL
128356	10" x 14"	PL
128352	7" x 10"	AL
128355	10" x 14"	AL



129146	10" x 7"	SS
129149	14" x 10"	SS
129145	10" x 7"	PL
129148	14" x 10"	PL
129144	10" x 7"	AL
129147	14" x 10"	AL

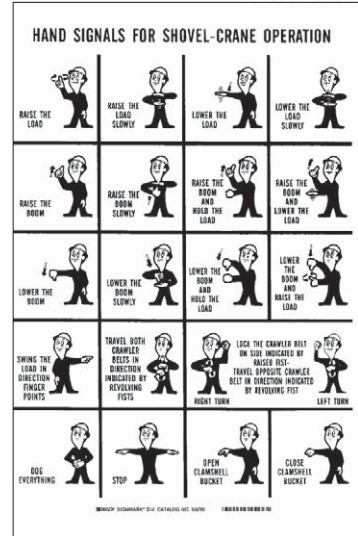

88298	10" x 7"	SS
88299	14" x 10"	SS
25048	10" x 7"	PL
25049	14" x 10"	PL
42626	14" x 10"	AL

# Machine and Operational Signs

BradyID.com/s34

## Machine and Operational Signs (Continued)



123865	7" x 10"	SS
123868	10" x 14"	SS
123864	7" x 10"	PL
123867	10" x 14"	PL
123863	7" x 10"	AL
123866	10" x 14"	AL



88513	7" x 7"	SS
25177	7" x 10"	PL
42754	7" x 10"	AL



129152	10" x 7"	SS
129155	14" x 10"	SS
129151	10" x 7"	PL
129154	14" x 10"	PL
129150	10" x 7"	AL
129153	14" x 10"	AL



88305	3-1/2" x 10"	SS
-------	--------------	----



69416	10" x 14"	FB
88310	7" x 10"	SS
88311	10" x 14"	SS
25050	7" x 10"	PL
25051	10" x 14"	PL
42627	7" x 10"	AL
42628	10" x 14"	AL



127964	7" x 10"	SS
127967	10" x 14"	SS
127963	7" x 10"	PL
127966	10" x 14"	PL
127962	7" x 10"	AL
127965	10" x 14"	AL



128288	7" x 10"	SS
128291	10" x 14"	SS
128287	7" x 10"	PL
128290	10" x 14"	PL
128286	7" x 10"	AL
128289	10" x 14"	AL



123841	10" x 7"	SS
123844	14" x 10"	SS
123840	10" x 7"	PL
123843	14" x 10"	PL
123839	10" x 7"	AL
123842	14" x 10"	AL



128390	7" x 10"	SS
128393	10" x 14"	SS
128389	7" x 10"	PL
128392	10" x 14"	PL
128388	7" x 10"	AL
128391	10" x 14"	AL

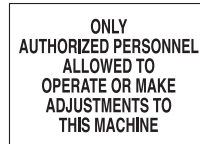

88307	3-1/2" x 10"	SS
-------	--------------	----



128324	10" x 7"	SS
128327	14" x 10"	SS
128323	10" x 7"	PL
128326	14" x 10"	PL
128322	10" x 7"	AL
128325	14" x 10"	AL



69460	10" x 14"	FB
88314	7" x 10"	SS
88315	10" x 14"	SS
42632	10" x 14"	AL



123847	7" x 10"	SS
123850	10" x 14"	SS
123846	7" x 10"	PL
123849	10" x 14"	PL
123845	7" x 10"	AL
123848	10" x 14"	AL



123835	7" x 10"	SS
123838	10" x 14"	SS
123834	7" x 10"	PL
123837	10" x 14"	PL
123833	7" x 10"	AL
123836	10" x 14"	AL



69430	10" x 10"	FB
88521	10" x 10"	SS
25183	10" x 14"	PL
42760	10" x 14"	AL



69456	10" x 14"	FB
88312	7" x 10"	SS
25052	7" x 10"	PL
25053	10" x 14"	PL
42630	10" x 14"	AL



127946	7" x 10"	SS
127949	10" x 14"	SS
127945	7" x 10"	PL
127948	10" x 14"	PL
127944	7" x 10"	AL
127947	10" x 14"	AL



88323	3-1/2" x 10"	SS
-------	--------------	----



88317	3-1/2" x 10"	SS
-------	--------------	----



88318	7" x 10"	SS
-------	----------	----



128366	7" x 10"	SS
128369	10" x 14"	SS
128365	7" x 10"	PL
128368	10" x 14"	PL
128364	7" x 10"	AL
128367	10" x 14"	AL



128378	7" x 10"	SS
128381	10" x 14"	SS
128377	7" x 10"	PL
128380	10" x 14"	PL
128376	7" x 10"	AL
128379	10" x 14"	AL



128372	7" x 10"	SS
128375	10" x 14"	SS
128371	7" x 10"	PL
128374	10" x 14"	PL
128370	7" x 10"	AL
128373	10" x 14"	AL



85145	3-1/2" x 10"	SS
-------	--------------	----



74415	7" x 10"	FB
88324	7" x 10"	SS
88325	10" x 14"	SS
25058	10" x 14"	PL
42634	7" x 10"	AL
42635	10" x 14"	AL



74429	10" x 14"	FB
88326	3-1/2" x 10"	SS
88327	7" x 10"	SS
88328	10" x 14"	SS
42636	7" x 10"	AL

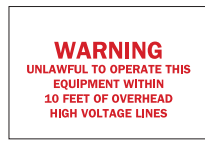

88329	7" x 10"	SS
88330	10" x 14"	SS



85147	3-1/2" x 10"	SS
-------	--------------	----



69238	10" x 10"	FB
88503	10" x 10"	SS
25168	10" x 14"	PL
42745	10" x 14"	AL



# Maintenance Signs

BradyID.com/s34

## Maintenance Signs

Brady maintenance signs remind employees to follow good housekeeping practices and help manage and sustain a clean and safe workplace. Brady offers more than 250 maintenance signs, each featuring a unique legend or pictogram.

Safety Signs



69783	10" x 14"	FB
85572	7" x 10"	SS
85573	10" x 14"	SS
25747	7" x 10"	PL
25748	10" x 14"	PL
43324	7" x 10"	AL
43325	10" x 14"	AL



85580	7" x 10"	SS
85581	10" x 14"	SS
25751	7" x 10"	PL
25752	10" x 14"	PL
43328	7" x 10"	AL
43329	10" x 14"	AL



69307	10" x 14"	FB
85582	7" x 10"	SS
85583	10" x 14"	SS
25753	7" x 10"	PL
25754	10" x 14"	PL
43331	10" x 14"	AL



73443	10" x 14"	FB
85584	7" x 10"	SS
25755	7" x 10"	PL
43332	7" x 10"	AL
43333	10" x 14"	AL



25758	10" x 14"	PL
-------	-----------	----



47115	10" x 14"	FB
85592	7" x 10"	SS
85593	10" x 14"	SS
25759	7" x 10"	PL
25760	10" x 14"	PL
43336	7" x 10"	AL
43337	10" x 14"	AL



122835	7" x 10"	FB
72975	10" x 14"	FB
85598	7" x 10"	SS
85599	10" x 14"	SS
22772	7" x 10"	PL
22773	10" x 14"	PL
41336	7" x 10"	AL
41337	10" x 14"	AL

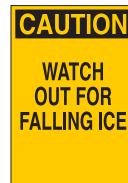

73439	18" x 12"	FB
-------	-----------	----



85604	7" x 10"	SS
85605	10" x 14"	SS
22776	7" x 10"	PL
22777	10" x 14"	PL



69087	10" x 14"	FB
85606	7" x 10"	SS
85607	10" x 14"	SS
41342	7" x 10"	AL



85610	7" x 10"	SS
22780	7" x 10"	PL



85614	7" x 10"	SS
22782	7" x 10"	PL



85620	7" x 10"	SS
22785	10" x 14"	PL
41348	7" x 10"	AL
41349	10" x 14"	AL



128414	7" x 10"	SS
128417	10" x 14"	SS
128413	7" x 10"	PL
128416	10" x 14"	PL
128412	7" x 10"	AL
128415	10" x 14"	AL



69012	10" x 14"	FB
85629	10" x 14"	SS
22790	7" x 10"	PL



69013	10" x 14"	FB
85631	10" x 14"	SS
22793	10" x 14"	PL
41357	10" x 14"	AL

### Popular Sign Materials

- FB** - Premium Fiberglass (B-120)
  - SS** - Self-Sticking Polyester (B-302)
  - SSV** - Reflective Vinyl (B-946)
  - BGSS** - BradyGlo™ Self-Sticking Polyester (B-324)
  - BGPL** - BradyGlo™ Plastic (B-347)
  - PL** - Plastic (B-401)
  - AL** - Aluminum (B-555)
- View all sign materials on page 25.*

### Can't find your sign?

*Use the Sign Legend Index on page 498 or take advantage of our custom sign options.*

### OSHA Regulations

#### Do Not Enter Lunchroom - 29 CFR 1926.62(i)(4)

The employer shall assure that employees do not enter lunchroom facilities or eating areas with protective work clothing or equipment unless surface lead dust has been removed by vacuuming, downdraft booth, other cleaning method that limits dispersion of lead dust.

#### Housekeeping, Keeping the Aisles Clean - 29 CFR 1910.22(a)(1)-(2)

Every workplace, including aisles, storerooms and service rooms must be kept clean and orderly, and in a sanitary condition. Work room floors should be kept dry, with adequate drainage provided.

#### No Food or Drink Beyond This Point 1910.141(g)

No employee shall be allowed to consume food or beverages in an area exposed to toxic material or in a toilet room.

#### Load Rating Plate 1910.22(d)

In every building or structure used for mercantile, business, industrial or storage purposes, the loads approved by the building official shall be marked on plates of approved design and shall be affixed by the owner of the building, or his authorized agent, in a conspicuous place in each space to which they relate.

## Maintenance Signs (Continued)

<p><b>NOTICE</b></p> <p>HELP KEEP THIS PLANT SAFE AND CLEAN</p> <p>85632 7" x 10" SS 85633 10" x 14" SS 22794 7" x 10" PL 22795 10" x 14" PL 41359 10" x 14" AL</p>	<p><b>NOTICE</b></p> <p>IF WE ARE TO HAVE EFFICIENCY IN OUR ORGANIZATION, WE MUST HAVE CLEANLINESS AND ORDER</p> <p>85634 7" x 10" SS 22796 7" x 10" PL 22797 10" x 14" PL 41360 7" x 10" AL</p>	<p><b>NOTICE</b></p> <p>KEEP THIS AREA CLEAN</p> <p>128420 7" x 10" SS 128423 10" x 14" SS 128419 7" x 10" PL 128422 10" x 14" PL 128418 7" x 10" AL 128421 10" x 14" AL</p>	<p><b>NOTICE</b></p> <p>NO EATING OR DRINKING IN THIS AREA</p> <p>85642 7" x 10" SS 85643 10" x 14" SS 22800 7" x 10" PL 22801 10" x 14" PL 41364 7" x 10" AL 41365 10" x 14" AL</p>	<p><b>NOTICE</b></p> <p>NO FOOD OR DRINK BEYOND THIS POINT</p> <p>70442 10" x 14" FB 85644 7" x 10" SS 85645 10" x 14" SS 22802 7" x 10" PL 22803 10" x 14" PL 41366 7" x 10" AL 41367 10" x 14" AL</p>	<p><b>NOTICE</b></p> <p>PASSAGE TO THIS FIRE HOUSE MUST BE KEPT CLEAR</p> <p>69425 10" x 14" FB 85211 7" x 10" SS 85212 10" x 14" SS 25687 10" x 14" PL</p>
<p><b>NOTICE</b></p> <p>PLACE CIGARETTES, CIGAR BUTTS AND ASHES IN RECEPTACLES</p> <p>85648 7" x 10" SS 85649 10" x 14" SS 22804 7" x 10" PL 22805 10" x 14" PL 41368 7" x 10" AL 41369 10" x 14" AL</p>	<p><b>NOTICE</b></p> <p>PLEASE WIPE YOUR FEET UPON ENTERING</p> <p>85650 7" x 10" SS 22806 7" x 10" PL 22807 10" x 14" PL 41370 7" x 10" AL 41371 10" x 14" AL</p>	<p><b>NOTICE</b></p> <p>PUT TOOLS BACK IN THEIR PROPER PLACE</p> <p>69455 10" x 14" FB 85652 7" x 10" SS 85653 10" x 14" SS 22808 7" x 10" PL 22809 10" x 14" PL 41372 7" x 10" AL 41373 10" x 14" AL</p>	<p><b>NOTICE</b></p> <p>SAFE FLOOR LOAD LIMIT NOT TO EXCEED _____ LBS. PER SQUARE FOOT</p> <p>47337 14" x 10" FB 85654 10" x 7" SS 85655 14" x 10" SS 22810 10" x 7" PL 22811 14" x 10" PL 41374 10" x 7" AL 41375 14" x 10" AL</p>	<p><b>PLEASE</b></p> <p>DEPOSIT ALL RUBBISH IN RECEPTACLES PROVIDED</p> <p>122856 7" x 10" FB 72623 10" x 14" FB 122655 7" x 10" SS 85659 10" x 14" SS 122524 7" x 10" PL 22813 10" x 14" PL 122416 7" x 10" AL 42336 10" x 14" AL</p>	<p><b>PLEASE</b></p> <p>DO NOT THROW PAPER TOWELS IN TOILET</p> <p>85662 7" x 10" SS 85663 10" x 14" SS</p>
<p><b>PLEASE</b></p> <p>DO NOT THROW PAPER TOWELS IN TOILET</p> <p>87715 10" x 14" FB 56691 10" x 14" SS 30544 10" x 14" PL</p>	<p><b>PLEASE</b></p> <p>FLUSH TOILET AFTER USING</p> <p>85664 7" x 10" SS 22816 7" x 10" PL 42339 7" x 10" AL 43352 10" x 14" AL</p>	<p><b>PLEASE</b></p> <p>FLUSH TOILET AFTER USING</p> <p>87716 10" x 14" FB 47526 10" x 14" SS 47518 10" x 14" PL</p>	<p><b>PLEASE</b></p> <p>KEEP THIS PLACE CLEAN AND ORDERLY</p> <p>72808 7" x 10" FB 85667 10" x 14" SS 85666 7" x 10" SS 22817 7" x 10" PL 22818 10" x 14" PL 42340 7" x 10" AL 42341 10" x 14" AL</p>	<p><b>PLEASE</b></p> <p>KEEP THIS PLACE CLEAN AND ORDERLY</p> <p>87717 10" x 14" FB 47550 10" x 14" SS 47532 10" x 14" PL 47533 10" x 14" AL</p>	<p><b>PLEASE</b></p> <p>PUT THINGS IN THEIR PROPER PLACE - AND YOU WILL FIND THEM WHEN YOU WANT THEM</p> <p>42341 10" x 14" AL 85668 7" x 10" SS 85669 10" x 14" SS 22819 7" x 10" PL 22820 10" x 14" PL 42342 7" x 10" AL 42343 10" x 14" AL</p>
<p><b>PLEASE</b></p> <p>THIS IS YOUR LUNCH AREA KEEP IT CLEAN</p> <p>78227 14" x 20" FB 85670 7" x 10" SS 85671 10" x 14" SS 22821 7" x 10" PL 22822 10" x 14" PL 42344 7" x 10" AL 42345 10" x 14" AL</p>	<p><b>RESTROOM CLOSED</b></p> <p>FOR CLEANING</p> <p>87736 10" x 14" FB 47618 10" x 14" PL</p>	<p><b>SAFETY FIRST</b></p> <p>KEEP THIS AREA CLEAN</p> <p>128432 7" x 10" SS 128435 10" x 14" SS 128431 7" x 10" PL 128434 10" x 14" PL 128430 7" x 10" AL 128433 10" x 14" AL</p>	<p><b>SAFETY FIRST</b></p> <p>KEEP THIS PLANT SAFE AND CLEAN</p> <p>128438 7" x 10" SS 128441 10" x 14" SS 128437 7" x 10" PL 128440 10" x 14" PL 128436 7" x 10" AL 128439 10" x 14" AL</p>	<p><b>SAFETY FIRST</b></p> <p>PLEASE DO NOT SPIT ON FLOOR</p> <p>22823 7" x 10" PL 22824 10" x 14" PL 42346 7" x 10" AL</p>	<p><b>THINK</b></p> <p>DO NOT SCATTER PAPER AND TRASH ON FLOORS THIS IS YOUR HOME FIVE DAYS A WEEK HELP KEEP IT CLEAN</p> <p>69143 10" x 14" FB 85686 7" x 10" SS 85687 10" x 14" SS 22825 7" x 10" PL</p>
<p><b>IS RESPONSIBLE FOR THE HOUSEKEEPING IN THIS AREA</b></p> <p>69282 10" x 14" FB 85692 7" x 10" SS 22828 7" x 10" PL 22829 10" x 14" PL</p>	<p><b>A CLEAN PLACE IS A SAFE PLACE</b></p> <p>69364 10" x 14" FB 85690 7" x 10" SS 85691 10" x 14" SS 22827 7" x 10" PL 42350 7" x 10" AL</p>	<p><b>A CLEAN WORK AREA IS A SAFE WORK AREA</b></p> <p>128192 7" x 10" SS 128195 10" x 14" SS 128191 7" x 10" PL 128194 10" x 14" PL 128190 7" x 10" AL 128193 10" x 14" AL</p>	<p><b>A CLUTTERED AREA IS A HAZARD</b></p> <p>PLEASE HELP KEEP THIS AREA CLEAN</p> <p>128198 7" x 10" SS 128201 10" x 14" SS 128197 7" x 10" PL 128200 10" x 14" PL 128196 7" x 10" AL 128199 10" x 14" AL</p>	<p><b>AVOID ACCIDENTS CLEAN UP SPILLS</b></p> <p>128204 7" x 10" SS 128207 10" x 14" SS 128203 7" x 10" PL 128206 10" x 14" PL 128202 7" x 10" AL 128205 10" x 14" AL</p>	<p><b>BEFORE YOU LEAVE</b></p> <p>Please CLEAN UP!</p> <p>128222 7" x 10" SS 128225 10" x 14" SS 128221 7" x 10" PL 128224 10" x 14" PL 128220 7" x 10" AL 128223 10" x 14" AL</p>



# Maintenance Signs

BradyID.com/s34

## Maintenance Signs (Continued)

Safety Signs



128210	7" x 10"	SS
128213	10" x 14"	SS
128209	7" x 10"	PL
128212	10" x 14"	PL
128208	7" x 10"	AL
128211	10" x 14"	AL



47116	14" x 10"	FB
85694	10" x 7"	SS
42353	10" x 7"	AL
42354	14" x 10"	AL



69044	10" x 14"	FB
85696	7" x 10"	SS
85697	10" x 14"	SS
22832	7" x 10"	PL



85703	10" x 14"	SS
22833	7" x 10"	PL
42356	7" x 10"	AL

**Popular Sign Materials**

- FB - Premium Fiberglass (B-120)
- SS - Self-Sticking Polyester (B-302)
- SSV - Reflective Vinyl (B-946)
- BGSS - BradyGlo™ Self-Sticking Polyester (B-324)
- BGPL - BradyGlo™ Plastic (B-347)
- PL - Plastic (B-401)
- AL - Aluminum (B-555)

*View all sign materials on page 25.*

**Can't find your sign?**  
*Use the Sign Legend Index on page 498 or take advantage of our custom sign options.*



128228	7" x 10"	SS
128231	10" x 14"	SS
128227	7" x 10"	PL
128230	10" x 14"	PL
128226	7" x 10"	AL
128229	10" x 14"	AL



128234	10" x 7"	SS
128237	14" x 10"	SS
128233	10" x 7"	PL
128236	14" x 10"	PL
128232	10" x 7"	AL
128235	14" x 10"	AL



128240	7" x 10"	SS
128243	10" x 14"	SS
128239	7" x 10"	PL
128242	10" x 14"	PL
128238	7" x 10"	AL
128241	10" x 14"	AL



85706	7" x 10"	SS
85707	10" x 14"	SS
22834	7" x 10"	PL
42357	7" x 10"	AL



72655	14" x 20"	FB
85708	7" x 10"	SS
85709	10" x 14"	SS
22835	7" x 10"	PL
22836	10" x 14"	PL



128246	7" x 10"	SS
128249	10" x 14"	SS
128245	7" x 10"	PL
128248	10" x 14"	PL
128244	7" x 10"	AL
128247	10" x 14"	AL



128252	7" x 10"	SS
128255	10" x 14"	SS
128251	7" x 10"	PL
128254	10" x 14"	PL
128250	7" x 10"	AL
128253	10" x 14"	AL



128258	10" x 7"	SS
128261	14" x 10"	SS
128257	10" x 7"	PL
128260	14" x 10"	PL
128256	10" x 7"	AL
128259	14" x 10"	AL



128264	7" x 10"	SS
128267	10" x 14"	SS
128263	7" x 10"	PL
128266	10" x 14"	PL
128262	7" x 10"	AL
128265	10" x 14"	AL



69008	10" x 14"	FB
85710	7" x 10"	SS
42360	7" x 10"	AL



70378	7" x 10"	FB
85717	10" x 14"	SS
22839	7" x 10"	PL
42362	7" x 10"	AL



128270	7" x 10"	SS
128273	10" x 14"	SS
128269	7" x 10"	PL
128272	10" x 14"	PL
128268	7" x 10"	AL
128271	10" x 14"	AL



72752	7" x 10"	FB
22840	7" x 10"	PL
22841	10" x 14"	PL
42363	7" x 10"	AL



128276	7" x 10"	SS
128279	10" x 14"	SS
128275	7" x 10"	PL
128278	10" x 14"	PL
128274	7" x 10"	AL
128277	10" x 14"	AL



72800	7" x 10"	FB
122721	10" x 14"	FB
85720	7" x 10"	SS
85721	10" x 14"	SS
22842	7" x 10"	PL
122474	10" x 14"	PL
42365	7" x 10"	AL
122350	10" x 14"	AL



85722	3-1/2" x 10"	SS
-------	--------------	----



128282	7" x 10"	SS
128285	10" x 14"	SS
128281	7" x 10"	PL
128284	10" x 14"	PL
128280	7" x 10"	AL
128283	10" x 14"	AL



122860	7" x 10"	FB
70436	10" x 14"	FB
85723	7" x 10"	SS
85724	10" x 14"	SS
22843	7" x 10"	PL
22844	10" x 14"	PL
122417	7" x 10"	AL
42367	10" x 14"	AL



22845	7" x 10"	PL
22846	10" x 14"	PL
42368	7" x 10"	AL
42369	10" x 14"	AL



73419	7" x 10"	FB
85730	10" x 14"	SS
22847	7" x 10"	PL



85733	7" x 10"	SS
22849	7" x 10"	PL
22850	10" x 14"	PL
42372	7" x 10"	AL
42373	10" x 14"	AL



128294	7" x 10"	SS
128297	10" x 14"	SS
128293	7" x 10"	PL
128296	10" x 14"	PL
128292	7" x 10"	AL
128295	10" x 14"	AL

# Maintenance Signs / No Cellular Phones

BradyID.com/s34

## Maintenance Signs (Continued)



128300	7" x 10"	SS
128303	10" x 14"	SS
128299	7" x 10"	PL
128302	10" x 14"	PL
128298	7" x 10"	AL
128301	10" x 14"	AL



128306	7" x 10"	SS
128309	10" x 14"	SS
128305	7" x 10"	PL
128308	10" x 14"	PL
128304	7" x 10"	AL
128307	10" x 14"	AL



69444	10" x 14"	FB
85737	7" x 10"	SS
85738	10" x 14"	SS
22851	7" x 10"	PL
22852	10" x 14"	PL
42375	10" x 14"	AL



85741	7" x 10"	SS
22853	7" x 10"	PL
22854	10" x 14"	PL



85745	7" x 10"	SS
85746	10" x 14"	SS



72949	10" x 14"	FB
22855	7" x 10"	PL
22856	10" x 14"	PL
42378	7" x 10"	AL



85750	7" x 10"	SS
85751	10" x 14"	SS
22857	7" x 10"	PL
42380	7" x 10"	AL

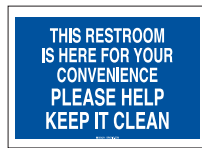

85752	7" x 10"	SS
85753	10" x 14"	SS
22858	7" x 10"	PL
42381	7" x 10"	AL



128336	7" x 10"	SS
128339	10" x 14"	SS
128335	7" x 10"	PL
128338	10" x 14"	PL
128334	7" x 10"	AL
128337	10" x 14"	AL



128318	10" x 7"	SS
128321	14" x 10"	SS
128317	10" x 7"	PL
128320	14" x 10"	PL
128316	10" x 7"	AL
128319	14" x 10"	AL

## No Cellular Phones Signs

Brady "No Cellular Phones" signs prohibit cell phones and two-way radios where the radio frequency, noise or distraction is a concern including blasting areas, quiet rooms, hospitals and other sensitive areas.



95501	10" x 14"	PL
-------	-----------	----



95500	10" x 14"	PL
-------	-----------	----



95499	10" x 14"	PL
-------	-----------	----



95498	10" x 14"	PL
-------	-----------	----



132039	7" x 10"	FB
132040	10" x 14"	FB
132037	7" x 10"	SS
132038	10" x 14"	SS
132036	7" x 10"	PL
132034	7" x 10"	AL
132035	10" x 14"	AL



122877	7" x 10"	FB
122738	10" x 14"	FB
122673	7" x 10"	SS
122596	10" x 14"	SS
122542	7" x 10"	PL
95503	10" x 14"	PL
95410	14" x 10"	PL
122433	7" x 10"	AL
122365	10" x 14"	AL



122878	7" x 10"	FB
122739	10" x 14"	FB
122674	7" x 10"	SS
122597	10" x 14"	SS
122543	7" x 10"	PL
95502	10" x 14"	PL
122434	7" x 10"	AL
122366	10" x 14"	AL



132032	7" x 10"	FB
132033	10" x 14"	FB
132030	7" x 10"	SS
132031	10" x 14"	SS
132029	7" x 10"	PL
132027	7" x 10"	AL
132028	10" x 14"	AL
122366	10" x 14"	AL



# No Smoking Signs

BradyID.com/s34

## No Smoking Signs

Brady "No Smoking" signs communicate to employees and visitors areas where smoking is prohibited. As state smoking bans increase in the U.S., Brady "No Smoking" signs are compliant with your state's smoking regulations and laws. Brady has more than 60 different "No Smoking" signs in various sizes and materials for indoor and outdoor use.

### Popular Sign Materials

- FB** - Premium Fiberglass (B-120)
  - SS** - Self-Sticking Polyester (B-302)
  - SSV** - Reflective Vinyl (B-946)
  - BGSS** - BradyGlo™ Self-Sticking Polyester (B-324)
  - BGPL** - BradyGlo™ Plastic (B-347)
  - PL** - Plastic (B-401)
  - AL** - Aluminum (B-555)
- View all sign materials on page 25.*

### Can't find your sign?

*Use the Sign Legend Index on page 498 or take advantage of our custom sign options.*



128108	7" x 10"	SS
128111	10" x 14"	SS
128107	7" x 10"	PL
128110	10" x 14"	PL
128106	7" x 10"	AL
128109	10" x 14"	AL



72285	14" x 20"	FB
88345	7" x 10"	SS
88346	10" x 14"	SS
25060	7" x 10"	PL
25061	10" x 14"	PL
42637	7" x 10"	AL
42638	10" x 14"	AL



72072	14" x 20"	FB
88347	7" x 10"	SS
88348	10" x 14"	SS
25062	7" x 10"	PL
25063	10" x 14"	PL
42639	7" x 10"	AL
42640	10" x 14"	AL



128102	7" x 10"	SS
128105	10" x 14"	SS
128101	7" x 10"	PL
128104	10" x 14"	PL
128100	7" x 10"	AL
128103	10" x 14"	AL



88351	7" x 10"	SS
88352	10" x 14"	SS
25064	7" x 10"	PL
25065	10" x 14"	PL
42641	7" x 10"	AL
42642	10" x 14"	AL



128132	7" x 10"	SS
128135	10" x 14"	SS
128131	7" x 10"	PL
128134	10" x 14"	PL
128130	7" x 10"	AL
128133	10" x 14"	AL



### OSHA Regulations

#### No Smoking 1910.106(e)(6)(i)

Adequate precautions shall be taken to prevent the ignition of flammable vapors. Sources of ignition include but are not limited to open flames; lightning; smoking...

#### Battery Charging Area 1910.178(g)(1)

Battery charging installations shall be located in areas designated for that purpose.

#### Hydrogen Marking 1910.103(b)(1)(v)

Hydrogen storage location shall be permanently placarded as follows: "HYDROGEN - FLAMMABLE GAS - NO SMOKING - NO OPEN FLAMES," or equivalent.

#### No Smoking, No Open Flames 1910.106(d)(7)(iii)

Open flames and smoking shall not be permitted in flammable liquid storage areas.



128120	7" x 10"	SS
128123	10" x 14"	SS
128119	7" x 10"	PL
128122	10" x 14"	PL
128118	7" x 10"	AL
128121	10" x 14"	AL



128138	7" x 10"	SS
128141	10" x 14"	SS
128137	7" x 10"	PL
128140	10" x 14"	PL
128136	7" x 10"	AL
128139	10" x 14"	AL



128126	7" x 10"	SS
128129	10" x 14"	SS
128125	7" x 10"	PL
128128	10" x 14"	PL
128124	7" x 10"	AL
128127	10" x 14"	AL



73437	10" x 14"	FB
85189	7" x 10"	SS
85190	10" x 14"	SS
25672	7" x 10"	PL
25673	10" x 14"	PL
43249	7" x 10"	AL
43250	10" x 14"	AL



88363	10" x 7"	SS
88364	14" x 10"	SS
25073	14" x 10"	PL
42649	10" x 7"	AL
42650	14" x 10"	AL



47171	7" x 10"	FB
47010	10" x 14"	FB
88369	3-1/2" x 5"	SS
88370	7" x 10"	SS
88371	10" x 14"	SS
25076	7" x 10"	PL
25077	10" x 14"	PL
42653	7" x 10"	AL
42654	10" x 14"	AL



95269	7" x 17"	FB
-------	----------	----



132003	7" x 10"	FB
132004	10" x 14"	FB
132001	7" x 10"	SS
132002	10" x 14"	SS
132000	7" x 10"	PL
25912	10" x 14"	PL
131999	7" x 10"	AL
43489	10" x 14"	AL



73416	7" x 17"	FB
-------	----------	----



72083	14" x 20"	FB
88374	7" x 10"	SS
88375	10" x 14"	SS
25078	7" x 10"	PL
25079	10" x 14"	PL
42655	7" x 10"	AL
42656	10" x 14"	AL



70452	7" x 17"	FB
-------	----------	----



143471	7" x 10"	SS
143472	10" x 14"	SS
143469	7" x 10"	PL
143470	10" x 14"	PL
143467	7" x 10"	AL
143468	10" x 14"	AL



## No Smoking Signs (Continued)



131785	7" x 10"	FB
131786	10" x 14"	FB
131783	7" x 10"	SS
131784	10" x 14"	SS
131781	7" x 10"	PL
131782	10" x 14"	PL
131779	7" x 10"	AL
131780	10" x 14"	AL



87797	3-1/2" x 5"	SS
-------	-------------	----



143477	7" x 10"	SS
143478	10" x 14"	SS
143475	7" x 10"	PL
143476	10" x 14"	PL
143473	7" x 10"	AL
143474	10" x 14"	AL



128144	7" x 10"	SS
128147	10" x 14"	SS
128143	7" x 10"	PL
128146	10" x 14"	PL
128142	7" x 10"	AL
128145	10" x 14"	AL



122817	7" x 10"	FB
47203	10" x 14"	FB
75670	14" x 20"	FB
88376	7" x 10"	SS
88377	10" x 14"	SS
25080	7" x 10"	PL
25081	10" x 14"	PL
42657	7" x 10"	AL
42658	10" x 14"	AL
95154	10" x 14"	Reflective Vinyl



131737	7" x 10"	FB
131738	10" x 14"	FB
131735	7" x 10"	SS
131736	10" x 14"	SS
131733	7" x 10"	PL
131734	10" x 14"	PL
131731	7" x 10"	AL
131732	10" x 14"	AL



122818	7" x 10"	FB
72118	10" x 14"	FB
87796	3-1/2" x 5"	SS
88378	7" x 10"	SS
88379	10" x 14"	SS
25082	7" x 10"	PL
25083	10" x 14"	PL
42659	7" x 10"	AL
42660	10" x 14"	AL



43504	10" x 14"	AL
-------	-----------	----



143494	10" x 14"	FB
143491	14" x 20"	FB
143493	7" x 10"	SS
143496	10" x 14"	SS
143495	10" x 14"	PL
143492	7" x 10"	AL
143497	10" x 14"	AL



72133	14" x 20"	FB
88380	7" x 10"	SS
88381	10" x 14"	SS
25084	7" x 10"	PL
25085	10" x 14"	PL
42661	7" x 10"	AL
42662	10" x 14"	AL



73466	10" x 14"	FB
88382	7" x 10"	SS
88383	10" x 14"	SS
25086	7" x 10"	PL
25087	10" x 14"	PL
42663	7" x 10"	AL
42664	10" x 14"	AL



128150	7" x 10"	SS
128153	10" x 14"	SS
128149	7" x 10"	PL
128152	10" x 14"	PL
128148	7" x 10"	AL
128151	10" x 14"	AL



143483	7" x 10"	SS
143484	10" x 14"	SS
143481	7" x 10"	PL
143482	10" x 14"	PL
143479	7" x 10"	AL
143480	10" x 14"	AL



143489	7" x 10"	SS
143490	10" x 14"	SS
143487	7" x 10"	PL
143488	10" x 14"	PL
143485	7" x 10"	AL
143486	10" x 14"	AL



128156	7" x 10"	SS
128159	10" x 14"	SS
128155	7" x 10"	PL
128158	10" x 14"	PL
128154	7" x 10"	AL
128157	10" x 14"	AL



88384	7" x 10"	SS
25088	7" x 10"	PL
25089	10" x 14"	PL
42665	7" x 10"	AL
42666	10" x 14"	AL



70509	7" x 17"	FB
-------	----------	----



72342	10" x 14"	FB
88449	7" x 10"	SS
88450	10" x 14"	SS
25132	7" x 10"	PL
25133	10" x 14"	PL
42710	10" x 14"	AL



132011	7" x 10"	FB
132012	10" x 14"	FB
132009	7" x 10"	SS
132010	10" x 14"	SS
132007	7" x 10"	PL
132008	10" x 14"	PL
132005	7" x 10"	AL
132006	10" x 14"	AL



88386	7" x 10"	SS
88387	10" x 14"	SS
25090	7" x 10"	PL
25091	10" x 14"	PL
42667	7" x 10"	AL



128162	7" x 10"	SS
128165	10" x 14"	SS
128161	7" x 10"	PL
128164	10" x 14"	PL
128160	7" x 10"	AL
128163	10" x 14"	AL



88388	7" x 10"	SS
88389	10" x 14"	SS
25092	7" x 10"	PL
25093	10" x 14"	PL
42669	7" x 10"	AL
42670	10" x 14"	AL



72328	7" x 10"	FB
72329	10" x 14"	FB
88392	7" x 10"	SS
88393	10" x 14"	SS
25094	7" x 10"	PL
25095	10" x 14"	PL
42671	7" x 10"	AL
42672	10" x 14"	AL



143465	7" x 10"	SS
143466	10" x 14"	SS
143463	7" x 10"	PL
143464	10" x 14"	PL
143461	7" x 10"	AL
143462	10" x 14"	AL



128168	7" x 10"	SS
128171	10" x 14"	SS
128167	7" x 10"	PL
128170	10" x 14"	PL
128166	7" x 10"	AL
128169	10" x 14"	AL



73427	10" x 14"	FB
84177	7" x 10"	SS
84178	10" x 14"	SS
22179	7" x 10"	PL
22180	10" x 14"	PL
40744	10" x 14"	AL



88394	7" x 10"	SS
25097	10" x 14"	PL
42674	10" x 14"	AL



# No Smoking Signs

BradyID.com/s34

## No Smoking Signs (Continued)

Safety Signs



69568	10" x 14"	FB
88396	7" x 10"	SS
88397	10" x 14"	SS
25098	7" x 10"	PL
25099	10" x 14"	PL
42675	7" x 10"	AL
42676	10" x 14"	AL



69599	10" x 14"	FB
88400	7" x 10"	SS
88401	10" x 14"	SS
25100	7" x 10"	PL
25101	10" x 14"	PL
42677	7" x 10"	AL
42678	10" x 14"	AL



69601	10" x 14"	FB
88402	7" x 10"	SS
88403	10" x 14"	SS
25102	7" x 10"	PL
25103	10" x 14"	PL
42679	7" x 10"	AL
42680	10" x 14"	AL



128174	7" x 10"	SS
128177	10" x 14"	SS
128173	7" x 10"	PL
128176	10" x 14"	PL
128172	7" x 10"	AL
128175	10" x 14"	AL

**Popular Sign Materials**

- FB - Premium Fiberglass (B-120)
- SS - Self-Sticking Polyester (B-302)
- SSV - Reflective Vinyl (B-946)
- BGSS - BradyGlo™ Self-Sticking Polyester (B-324)
- BGPL - BradyGlo™ Plastic (B-347)
- PL - Plastic (B-401)
- AL - Aluminum (B-555)

View all sign materials on page 25.

**Can't find your sign?**  
Use the Sign Legend Index on page 498 or take advantage of our custom sign options.



128186	7" x 10"	SS
128189	10" x 14"	SS
128185	7" x 10"	PL
128188	10" x 14"	PL
128184	7" x 10"	AL
128187	10" x 14"	AL



69600	10" x 14"	FB
88404	7" x 10"	SS
88405	10" x 14"	SS
25104	7" x 10"	PL
25105	10" x 14"	PL
42681	7" x 10"	AL
42682	10" x 14"	AL



128180	7" x 10"	SS
128183	10" x 14"	SS
128179	7" x 10"	PL
128182	10" x 14"	PL
128178	7" x 10"	AL
128181	10" x 14"	AL



69792	7" x 7"	FB
88520	7" x 7"	SS
25182	7" x 10"	PL
42759	7" x 10"	AL



88410	3-1/2" x 10"	SS
-------	--------------	----



122906	7" x 10"	FB
46990	10" x 14"	FB
88411	7" x 10"	SS
88412	10" x 14"	SS
25108	7" x 10"	PL
122496	10" x 14"	PL
42685	7" x 10"	AL
122384	10" x 14"	AL



127994	10" x 7"	SS
127997	14" x 10"	SS
127993	10" x 7"	PL
127996	14" x 10"	PL
127992	10" x 7"	AL
127995	14" x 10"	AL



127988	7" x 10"	SS
127991	10" x 14"	SS
127987	7" x 10"	PL
127990	10" x 14"	PL
127986	7" x 10"	AL
127989	10" x 14"	AL



127976	7" x 10"	SS
127979	10" x 14"	SS
127975	7" x 10"	PL
127978	10" x 14"	PL
127974	7" x 10"	AL
127977	10" x 14"	AL



127970	7" x 10"	SS
127973	10" x 14"	SS
127969	7" x 10"	PL
127972	10" x 14"	PL
127968	7" x 10"	AL
127971	10" x 14"	AL



127982	7" x 10"	SS
127985	10" x 14"	SS
127981	7" x 10"	PL
127984	10" x 14"	PL
127980	7" x 10"	AL
127983	10" x 14"	AL



72255	14" x 20"	FB
88413	14" x 20"	SS
88414	10" x 14"	SS
25109	7" x 10"	PL
42686	7" x 10"	AL



87677	14" x 10"	FB
-------	-----------	----



72009	5" x 14"	FB
88421	3-1/2" x 10"	SS
88422	5" x 14"	SS
25114	7" x 10"	PL
42691	7" x 10"	AL



88423	7" x 10"	SS
88424	10" x 14"	SS
25115	7" x 10"	PL
25116	10" x 14"	PL
42692	7" x 10"	AL
42693	10" x 14"	AL



80248	7" x 10"	BGSS
80249	10" x 14"	BGSS
85482	7" x 10"	BGPL
85483	10" x 14"	BGPL



72022	7" x 10"	FB
72024	10" x 14"	FB
89176	3-1/2" x 5"	SS
89154	5" x 14"	SS
88425	7" x 10"	SS
88426	10" x 14"	SS
25117	7" x 10"	PL
25118	10" x 14"	PL
42694	7" x 10"	AL
42695	10" x 14"	AL



72040	5" x 14"	FB
88418	5" x 14"	SS
25110	7" x 10"	PL
42687	7" x 10"	AL



141944	10" x 14"	FB
141949	14" x 20"	FB
141945	10" x 14"	SS
141950	14" x 20"	SS
141948	10" x 14"	PL
141953	14" x 20"	PL
141946	10" x 14"	AL
141951	14" x 20"	AL
141947	10" x 14"	SSV
141952	14" x 20"	SSV



73487	10" x 14"	FB
88443	7" x 10"	SS
88444	10" x 14"	SS



72293	10" x 7"	FB
73486	14" x 10"	FB
72295	20" x 14"	FB
87795	3-1/2" x 5"	SS
88427	10" x 7"	SS
88428	14" x 10"	SS
25119	10" x 7"	PL
25120	14" x 10"	PL
42696	10" x 7"	AL
42697	14" x 10"	AL



72049	14" x 20"	FB
88429	7" x 10"	SS
88430	10" x 14"	SS
25121	7" x 10"	PL
42698	7" x 10"	AL



70450	14" x 20"	FB
88432	10" x 14"	SS
25122	7" x 10"	PL
42699	7" x 10"	AL



141939	10" x 7"	FB
141940	10" x 7"	PL
141943	10" x 7"	PL
141941	10" x 7"	AL
141942	10" x 7"	SSV

## No Smoking Signs (Continued)



141919	10" x 14"	FB
141920	10" x 14"	PL
141923	10" x 14"	PL
141921	10" x 14"	AL
141922	10" x 14"	SSV



72055	5" x 14"	FB
88433	3-1/2" x 10"	SS
88434	5" x 14"	SS



25123	7" x 10"	PL
25884	10" x 14"	PL
42700	7" x 10"	AL
43461	10" x 14"	AL



88435	7" x 10"	SS
88436	10" x 14"	SS
25124	7" x 10"	PL
42701	7" x 10"	AL



141924	10" x 7"	FB
141925	10" x 7"	PL
141928	10" x 7"	PL
141926	10" x 7"	AL
141928	10" x 7"	SSV



46993	10" x 14"	FB
88437	7" x 10"	SS
88438	10" x 14"	SS
42702	7" x 10"	AL



128006	10" x 7"	SS
128009	14" x 10"	SS
128005	10" x 7"	PL
128008	14" x 10"	PL
128004	10" x 7"	AL
128007	14" x 10"	AL



72091	14" x 20"	FB
88439	7" x 10"	SS
88440	10" x 14"	SS
25126	7" x 10"	PL
42703	7" x 10"	AL



128000	10" x 7"	SS
128003	14" x 10"	SS
127999	10" x 7"	PL
128002	14" x 10"	PL
127998	10" x 7"	AL
128001	14" x 10"	AL



128036	7" x 10"	SS
128039	10" x 14"	SS
128035	7" x 10"	PL
128038	10" x 14"	PL
128034	7" x 10"	AL
128037	10" x 14"	AL



141964	10" x 14"	FB
141969	14" x 20"	FB
141965	10" x 14"	SS
141970	14" x 20"	SS
141968	10" x 14"	PL
141973	14" x 20"	PL
141966	10" x 14"	AL
141971	14" x 20"	AL
141967	10" x 14"	SSV
141972	14" x 20"	SSV



141954	10" x 14"	FB
141955	10" x 14"	SS
141957	10" x 14"	PL
141956	10" x 14"	AL
141958	10" x 14"	SSV



72097	14" x 20"	FB
88441	7" x 10"	SS
88442	10" x 14"	SS
25127	7" x 10"	PL
42704	7" x 10"	AL



47172	7" x 10"	FB
88445	7" x 10"	SS
88446	7" x 10"	SS
88447	10" x 14"	SS
25130	10" x 14"	PL
42706	7" x 10"	AL
42707	10" x 14"	AL



141959	10" x 7"	FB
141960	10" x 7"	PL
141963	10" x 7"	PL
141961	10" x 7"	AL
141962	10" x 7"	SSV



123893	10" x 7"	SS
123896	14" x 10"	SS
123892	10" x 7"	PL
123895	14" x 10"	PL
123891	10" x 7"	AL
123894	14" x 10"	AL



128012	10" x 7"	SS
128015	14" x 10"	SS
128011	10" x 7"	PL
128014	14" x 10"	PL
128010	10" x 7"	AL
128013	14" x 10"	AL



128024	7" x 10"	SS
128027	10" x 14"	SS
128023	7" x 10"	PL
128026	10" x 14"	PL
128022	7" x 10"	AL
128025	10" x 14"	AL



# No Smoking Signs

BradyID.com/s34

## No Smoking Signs (Continued)



123941	10" x 7"	SS
123944	14" x 10"	SS
123940	10" x 7"	PL
123943	14" x 10"	PL
123939	10" x 7"	AL
123942	14" x 10"	AL



88448	5" x 14"	SS
-------	----------	----



25131	7" x 10"	PL
42708	7" x 10"	AL



128030	7" x 10"	SS
128033	10" x 14"	SS
128029	7" x 10"	PL
128032	10" x 14"	PL
128028	7" x 10"	AL
128031	10" x 14"	AL

### Popular Sign Materials

**FB** - Premium Fiberglass (B-120)  
**SS** - Self-Sticking Polyester (B-302)  
**SSV** - Reflective Vinyl (B-946)  
**BGSS** - BradyGlo™ Self-Sticking Polyester (B-324)  
**BGPL** - BradyGlo™ Plastic (B-347)  
**PL** - Plastic (B-401)  
**AL** - Aluminum (B-555)  
 View all sign materials on page 25.  
**Can't find your sign?**  
 Use the Sign Legend Index on page 498 or take advantage of our custom sign options.



122795	7" x 10"	FB
72148	10" x 14"	FB
88451	7" x 10"	SS
88452	10" x 14"	SS
25134	7" x 10"	PL
25135	10" x 14"	PL
42711	7" x 10"	AL
42712	10" x 14"	AL



128042	7" x 10"	SS
128045	10" x 14"	SS
128041	7" x 10"	PL
128044	10" x 14"	PL
128040	7" x 10"	AL
128043	10" x 14"	AL



128018	10" x 7"	SS
128021	14" x 10"	SS
128017	10" x 7"	PL
128020	14" x 10"	PL
128016	10" x 7"	AL
128019	14" x 10"	AL



110977	10" x 7"	FB
110976	14" x 10"	FB
110978	10" x 7"	SS
110979	14" x 10"	SS
110975	10" x 7"	PL
110973	10" x 7"	AL
110972	14" x 10"	AL



122703	10" x 14"	FB
72155	14" x 20"	FB
88453	7" x 10"	SS
88454	7" x 10"	SS
25136	7" x 10"	PL
25137	10" x 14"	PL
42713	7" x 10"	AL
42714	10" x 14"	AL



123917	7" x 10"	SS
123920	10" x 14"	SS
123916	7" x 10"	PL
123919	10" x 14"	PL
123915	7" x 10"	AL
123918	10" x 14"	AL



128048	7" x 10"	SS
128051	10" x 14"	SS
128047	7" x 10"	PL
128050	10" x 14"	PL
128046	7" x 10"	AL
128049	10" x 14"	AL



124642	10" x 3-1/2"	SS
124641	10" x 3-1/2"	PL
124640	10" x 3-1/2"	AL



128054	10" x 7"	SS
128057	14" x 10"	SS
128053	10" x 7"	PL
128056	14" x 10"	PL
128052	10" x 7"	AL
128055	14" x 10"	AL



75972	7" x 10"	FB
75973	10" x 14"	FB
88457	7" x 10"	SS
88458	10" x 14"	SS
25139	7" x 10"	PL
25140	10" x 14"	PL
42716	7" x 10"	AL
42717	10" x 14"	AL



128072	7" x 10"	SS
128075	10" x 14"	SS
128071	7" x 10"	PL
128074	10" x 14"	PL
128070	7" x 10"	AL
128073	10" x 14"	AL



70730	10" x 14"	FB
-------	-----------	----



122796	7" x 10"	FB
72176	10" x 14"	FB
88467	7" x 10"	SS
88468	10" x 14"	SS
25144	7" x 10"	PL
122468	10" x 14"	PL
42721	7" x 10"	AL
122342	10" x 14"	AL



128060	10" x 7"	SS
128063	14" x 10"	SS
128059	10" x 7"	PL
128062	14" x 10"	PL
128058	10" x 7"	AL
128061	14" x 10"	AL



123899	10" x 7"	SS
123902	14" x 10"	SS
123898	10" x 7"	PL
123901	14" x 10"	PL
123897	10" x 7"	AL
123900	14" x 10"	AL



128066	10" x 7"	SS
128069	14" x 10"	SS
128065	10" x 7"	PL
128068	14" x 10"	PL
128064	10" x 7"	AL
128067	14" x 10"	AL



72296	10" x 7"	FB
72297	14" x 10"	FB
72298	20" x 14"	FB
88469	10" x 7"	SS
88470	14" x 10"	SS
25145	10" x 7"	PL
42722	10" x 7"	AL
42723	14" x 10"	AL

## No Smoking Signs (Continued)



122797	7" x 10"	FB
72336	10" x 14"	FB
88471	7" x 10"	SS
88472	10" x 14"	SS
25147	7" x 10"	PL
25148	10" x 14"	PL
42724	7" x 10"	AL
42725	10" x 14"	AL



128078	7" x 10"	SS
128081	10" x 14"	SS
128077	7" x 10"	PL
128080	10" x 14"	PL
128076	7" x 10"	AL
128079	10" x 14"	AL



123905	10" x 7"	SS
123908	14" x 10"	SS
123904	10" x 7"	PL
123907	14" x 10"	PL
123903	10" x 7"	AL
123906	14" x 10"	AL



128084	7" x 10"	SS
128087	10" x 14"	SS
128083	7" x 10"	PL
128086	10" x 14"	PL
128082	7" x 10"	AL
128085	10" x 14"	AL



87691	10" x 14"	FB
87684	7" x 10"	SS
87685	10" x 14"	SS
87687	10" x 14"	PL
87688	7" x 10"	AL
87689	10" x 14"	AL



72341	10" x 14"	FB
72343	7" x 10"	SS
72344	10" x 14"	SS
72347	7" x 10"	PL
72348	10" x 14"	PL
72345	7" x 10"	AL
72346	10" x 14"	AL



141929	10" x 14"	FB
141934	14" x 20"	FB
141930	10" x 14"	SS
141935	14" x 20"	SS
141933	10" x 14"	PL
141938	14" x 20"	PL
141931	10" x 14"	AL
141936	14" x 20"	AL
141932	10" x 14"	SSV
141937	14" x 20"	SSV



128090	7" x 10"	SS
128093	10" x 14"	SS
128089	7" x 10"	PL
128092	10" x 14"	PL
128088	7" x 10"	AL
128091	10" x 14"	AL



123923	10" x 7"	SS
123926	14" x 10"	SS
123922	10" x 7"	PL
123925	14" x 10"	PL
123921	10" x 7"	AL
123924	14" x 10"	AL



123911	7" x 10"	SS
123914	10" x 14"	SS
123910	7" x 10"	PL
123913	10" x 14"	PL
123909	7" x 10"	AL
123912	10" x 14"	AL



123929	7" x 10"	SS
123932	10" x 14"	SS
123928	7" x 10"	PL
123931	10" x 14"	PL
123927	7" x 10"	AL
123930	10" x 14"	AL



72349	7" x 10"	FB
72355	7" x 10"	SS
72395	10" x 14"	SS
72398	7" x 10"	PL
72399	10" x 14"	PL
72396	7" x 10"	AL
72397	10" x 14"	AL



128096	7" x 10"	SS
128099	10" x 14"	SS
128095	7" x 10"	PL
128098	10" x 14"	PL
128094	7" x 10"	AL
128097	10" x 14"	AL



123935	10" x 7"	SS
123938	14" x 10"	SS
123934	10" x 7"	PL
123937	14" x 10"	PL
123933	10" x 7"	AL
123936	14" x 10"	AL



128114	10" x 7"	SS
128117	14" x 10"	SS
128113	10" x 7"	PL
128116	14" x 10"	PL
128112	10" x 7"	AL
128115	14" x 10"	AL

## Custom Signs

Brady's "Same as Stock" custom sign pricing makes it easy to create signs unique to your facility.

**View page 194 for more information.**

Safety Signs



# Personal Hygiene Signs

BradyID.com/s34

## Personal Hygiene Signs

Brady personal hygiene signs remind and encourage employees to use appropriate sanitary methods such as hand washing and use of hair nets before returning to work.

### Popular Sign Materials

- FB** - Premium Fiberglass (B-120)
- SS** - Self-Sticking Polyester (B-302)
- BGSS** - BradyGlo™ Self-Sticking Polyester (B-324)
- BGPL** - BradyGlo™ Plastic (B-347)
- PL** - Plastic (B-401)
- AL** - Aluminum (B-555)

View all sign materials on page 25.

### Can't find your sign?

Use the Sign Legend Index on page 498 or take advantage of our custom sign options.



30705 10" x 14" SS  
30707 10" x 14" PL



47579 10" x 14" PL



128456 10" x 7" SS  
128459 14" x 10" SS  
128455 10" x 7" PL  
128458 14" x 10" PL  
128454 10" x 7" AL  
128457 14" x 10" AL



122789 7" x 10" FB  
73474 10" x 14" FB  
88475 7" x 10" SS  
88476 10" x 14" SS  
25149 7" x 10" PL  
25150 10" x 14" PL  
42726 7" x 10" AL  
42727 10" x 14" AL



72988 14" x 20" FB  
88477 7" x 10" SS  
88478 10" x 14" SS  
25151 7" x 10" PL  
25152 10" x 14" PL  
42728 7" x 10" AL  
42729 10" x 14" AL



88479 7" x 10" SS  
88480 10" x 14" SS  
25153 7" x 10" PL  
25154 10" x 14" PL  
42730 7" x 10" AL  
42731 10" x 14" AL



69567 10" x 14" FB  
88485 7" x 10" SS  
88486 10" x 14" SS  
25155 7" x 10" PL  
25156 10" x 14" PL  
42732 7" x 10" AL  
42733 10" x 14" AL



128450 10" x 7" SS  
128453 14" x 10" SS  
128449 10" x 7" PL  
128452 14" x 10" PL  
128448 10" x 7" AL  
128451 14" x 10" AL



87732 10" x 14" FB  
30911 10" x 14" SS  
30913 10" x 14" PL  
30914 10" x 14" AL



47636 10" x 7" SS  
47638 10" x 7" PL  
47639 10" x 7" AL



47587 10" x 14" SS  
57079 10" x 14" AL



47593 10" x 14" SS  
47595 10" x 14" PL



47606 10" x 14" SS  
47612 10" x 14" PL  
57080 10" x 14" AL



128312 10" x 7" SS  
128315 14" x 10" SS  
128311 10" x 7" PL  
128314 14" x 10" PL  
128310 10" x 7" AL  
128313 14" x 10" AL



128330 7" x 10" SS  
128333 10" x 14" SS  
128329 7" x 10" PL  
128332 10" x 14" PL  
128328 7" x 10" AL  
128331 10" x 14" AL



87738 10" x 14" FB  
57084 10" x 14" SS  
47632 10" x 14" PL



31218 10" x 14" PL  
31219 10" x 14" AL



88682 7" x 10" SS  
88683 10" x 14" SS  
25250 7" x 10" PL  
25251 10" x 14" PL  
42828 10" x 14" AL



128384 7" x 10" SS  
128387 10" x 14" SS  
128383 7" x 10" PL  
128386 10" x 14" PL  
128382 7" x 10" AL  
128385 10" x 14" AL



47649 10" x 7" SS  
47651 10" x 7" PL  
47652 10" x 7" AL



88684 3-1/2" x 10" SS

## Personal Protection Signs

Brady's full line of personal protection signs remind employees and floor workers about areas that require a hardhat, ear protection, face shields, eye protection or other garment. Brady personal protection signs are a strong and noticeable reminder for your employees to maintain a safe work atmosphere.



22575	7' x 10'	PL
22576	10' x 14'	PL



129032	7' x 10'	SS
129035	10' x 14'	SS
129031	7' x 10'	PL
129034	10' x 14'	PL
129030	7' x 10'	AL
129033	10' x 14'	AL



124225	10' x 7'	SS
124228	14' x 10'	SS
124224	10' x 7'	PL
124227	14' x 10'	PL
124223	10' x 7'	AL
124226	14' x 10'	AL



129038	7' x 10'	SS
129041	10' x 14'	SS
129037	7' x 10'	PL
129040	10' x 14'	PL
129036	7' x 10'	AL
129039	10' x 14'	AL



131949	7' x 10'	FB
131950	10' x 14'	FB
131947	7' x 10'	SS
131948	10' x 14'	SS
131945	7' x 10'	PL
131946	10' x 14'	PL
131943	7' x 10'	AL
131944	10' x 14'	AL



128516	7' x 10'	SS
128519	10' x 14'	SS
128515	7' x 10'	PL
128518	10' x 14'	PL
128514	7' x 10'	AL
128517	10' x 14'	AL



69041	10' x 14'	FB
84971	7' x 10'	SS
84972	10' x 14'	SS
22577	7' x 10'	PL
22578	10' x 14'	PL
41141	7' x 10'	AL
41142	10' x 14'	AL



131941	7' x 10'	FB
131942	10' x 14'	FB
131939	7' x 10'	SS
131940	10' x 14'	SS
131937	7' x 10'	PL
131938	10' x 14'	PL
131935	7' x 10'	AL
131936	10' x 14'	AL



47056	7' x 10'	FB
47094	10' x 14'	FB
84973	7' x 10'	SS
22579	7' x 10'	PL
22580	10' x 14'	PL
41143	7' x 10'	AL



47059	7' x 10'	FB
84975	7' x 10'	SS
84976	10' x 14'	SS
22581	7' x 10'	PL
25773	10' x 14'	PL
41145	7' x 10'	AL
43350	10' x 14'	AL



70286	10' x 14'	FB
85079	7' x 10'	SS
85080	10' x 14'	SS
25594	7' x 10'	PL
25595	10' x 14'	PL
43171	7' x 10'	AL
43172	10' x 14'	AL



74542	20' x 14'	FB
84977	10' x 7'	SS
22582	10' x 7'	PL
22583	14' x 10'	PL
41146	10' x 7'	AL



70288	7' x 10'	FB
25192	7' x 10'	PL
25193	10' x 14'	PL
42769	7' x 10'	AL



105729	14' x 10'	FB
--------	-----------	----



128522	7' x 10'	SS
128525	10' x 14'	SS
128521	7' x 10'	PL
128524	10' x 14'	PL
128520	7' x 10'	AL
128523	10' x 14'	AL



88543	7' x 10'	SS
88544	10' x 14'	SS
25194	7' x 10'	PL
25195	10' x 14'	PL
42771	7' x 10'	AL
42772	10' x 14'	AL



### OSHA Regulations

#### Safety Instruction Signs

##### 1910.145(c)(3)

Safety instruction signs shall be used where there is a need for general instructions and suggestions relative to safety measures.

#### Danger Signs

##### 1910.145(c)(1)(ii)

All employees shall be instructed that danger signs indicate immediate danger and that special precautions are necessary.

#### Caution Signs

##### 1910.145(c)(2)(i)

Caution signs shall be used only to warn against potential hazards or to caution against unsafe practices.

##### 1910.145(c)(2)(ii)

All employees shall be instructed that caution signs indicate a possible hazard against which proper precaution should be taken.



# Personal Protection Signs

BradyID.com/s34

## Personal Protection Signs (Continued)

Safety Signs



84774	7" x 10"	SS
84775	10" x 14"	SS
25454	7" x 10"	PL
43032	10" x 14"	AL



128528	7" x 10"	SS
128531	10" x 14"	SS
128527	7" x 10"	PL
128530	10" x 14"	PL
128526	7" x 10"	AL
128529	10" x 14"	AL



70299	20" x 14"	FB
84776	10" x 7"	SS
84777	14" x 10"	SS
25456	10" x 7"	PL
25457	14" x 10"	PL
43033	10" x 7"	AL
43034	14" x 10"	AL



84778	7" x 10"	SS
84779	10" x 14"	SS
25459	10" x 14"	PL
43035	7" x 10"	AL
43036	10" x 14"	AL

**Popular Sign Materials**

**FB** - Premium Fiberglass (B-120)  
**SS** - Self-Sticking Polyester (B-302)  
**BGSS** - BradyGlo™ Self-Sticking Polyester (B-324)  
**BGPL** - BradyGlo™ Plastic (B-347)  
**PL** - Plastic (B-401)  
**AL** - Aluminum (B-555)

*View all sign materials on page 25.*

**Can't find your sign?**  
*Use the Sign Legend Index on page 498 or take advantage of our custom sign options.*



25891	10" x 14"	PL
43468	10" x 14"	AL



70303	7" x 17"	FB
-------	----------	----



70305	10" x 14"	FB
84780	7" x 10"	SS
25460	7" x 10"	PL
25461	10" x 14"	PL
43037	7" x 10"	AL
43038	10" x 14"	AL



70302	10" x 14"	FB
84782	7" x 10"	SS
84783	10" x 14"	SS
25462	7" x 10"	PL
25463	10" x 14"	PL
43039	7" x 10"	AL
43040	10" x 14"	AL



69226	10" x 14"	FB
88545	7" x 10"	SS
88546	10" x 14"	SS
25196	7" x 10"	PL
25197	10" x 14"	PL
42773	7" x 10"	AL
42774	10" x 14"	AL



76070	10" x 14"	FB
88547	7" x 10"	SS
88548	10" x 14"	SS
25198	7" x 10"	PL
25199	10" x 14"	PL
42775	7" x 10"	AL
42776	10" x 14"	AL



69229	10" x 14"	FB
88551	7" x 10"	SS
88552	10" x 14"	SS
25200	7" x 10"	PL
25201	10" x 14"	PL
42777	7" x 10"	AL
42778	10" x 14"	AL



70335	7" x 17"	FB
-------	----------	----



47061	7" x 10"	FB
47050	10" x 14"	FB
87769	3-1/2" x 5"	SS
84529	7" x 10"	SS
84530	10" x 14"	SS
22399	7" x 10"	PL
22400	10" x 14"	PL
40964	10" x 14"	AL



122900	7" x 10"	FB
122762	10" x 14"	FB
122692	7" x 10"	SS
122616	10" x 14"	SS
122557	7" x 10"	PL
25892	10" x 14"	PL
122449	7" x 10"	AL
43469	10" x 14"	AL



73457	7" x 17"	FB
-------	----------	----



47100	10" x 14"	FB
84981	7" x 10"	SS
84982	10" x 14"	SS
22584	7" x 10"	PL
22585	10" x 14"	PL
41148	7" x 10"	AL
41149	10" x 14"	AL



84531	7" x 10"	SS
84532	10" x 14"	SS
22402	10" x 14"	PL
40965	7" x 10"	AL
40966	10" x 14"	AL



122839	7" x 10"	FB
70339	10" x 14"	FB
84983	7" x 10"	SS
84984	10" x 14"	SS
22586	7" x 10"	PL
22587	10" x 14"	PL
41150	7" x 10"	AL
41151	10" x 14"	AL



128534	7" x 10"	SS
128537	10" x 14"	SS
128533	7" x 10"	PL
128536	10" x 14"	PL
128532	7" x 10"	AL
128535	10" x 14"	AL



124261	7" x 10"	SS
124264	10" x 14"	SS
124260	7" x 10"	PL
124263	10" x 14"	PL
124259	7" x 10"	AL
124262	10" x 14"	AL



129044	7" x 10"	SS
129047	10" x 14"	SS
129043	7" x 10"	PL
129046	10" x 14"	PL
129042	7" x 10"	AL
129045	10" x 14"	AL



129050	7" x 10"	SS
129053	10" x 14"	SS
129049	7" x 10"	PL
129052	10" x 14"	PL
129048	7" x 10"	AL
129051	10" x 14"	AL



## Personal Protection Signs (Continued)



65039	10' x 14'	FB
89091	7' x 10'	SS
89090	10' x 14'	SS
25416	7' x 10'	PL
25417	10' x 14'	PL
42993	7' x 10'	AL
42994	10' x 14'	AL



70352	7' x 17'	FB
-------	----------	----



128618	10' x 7'	SS
128621	14' x 10'	SS
128617	10' x 7'	PL
128620	14' x 10'	PL
128616	10' x 7'	AL
128619	14' x 10'	AL



122841	7' x 10'	FB
70358	10' x 14'	FB
87770	3-1/2' x 5'	SS
84533	7' x 10'	SS
84534	10' x 14'	SS
22403	7' x 10'	PL
22404	10' x 14'	PL
40967	7' x 10'	AL
40968	10' x 14'	AL



131933	7' x 10'	FB
131934	10' x 14'	FB
131931	7' x 10'	SS
131932	10' x 14'	SS
131929	7' x 10'	PL
131930	10' x 14'	PL
131927	7' x 10'	AL
131928	10' x 14'	AL



124294	7' x 10'	SS
124297	10' x 14'	SS
124293	7' x 10'	PL
124296	10' x 14'	PL
124292	7' x 10'	AL
124295	10' x 14'	AL



128540	7' x 10'	SS
128543	10' x 14'	SS
128539	7' x 10'	PL
128542	10' x 14'	PL
128538	7' x 10'	AL
128541	10' x 14'	AL



70359	7' x 17'	FB
-------	----------	----



122833	7' x 10'	FB
74581	10' x 14'	FB
87771	3-1/2' x 5'	SS
84535	7' x 10'	SS
84536	10' x 14'	SS
122520	7' x 10'	PL
22406	10' x 14'	PL
122408	7' x 10'	AL
40970	10' x 14'	AL



131925	7' x 10'	FB
131926	10' x 14'	FB
131923	7' x 10'	SS
131924	10' x 14'	SS
131922	7' x 10'	PL
25893	10' x 14'	PL
131921	7' x 10'	AL
43470	10' x 14'	AL



124249	7' x 10'	SS
124252	10' x 14'	SS
124248	7' x 10'	PL
124251	10' x 14'	PL
124247	7' x 10'	AL
124250	10' x 14'	AL



128552	7' x 10'	SS
128555	10' x 14'	SS
128551	7' x 10'	PL
128554	10' x 14'	PL
128550	7' x 10'	AL
128553	10' x 14'	AL



128546	7' x 10'	SS
128549	10' x 14'	SS
128545	7' x 10'	PL
128548	10' x 14'	PL
128544	7' x 10'	AL
128547	10' x 14'	AL



122834	7' x 10'	FB
47101	10' x 14'	FB
75900	14' x 20'	FB
87778	3-1/2' x 5'	SS
84784	7' x 10'	SS
84785	10' x 14'	SS
25464	7' x 10'	PL
25465	10' x 14'	PL
43041	7' x 10'	AL
43042	10' x 14'	AL



47064	7' x 10'	FB
47018	10' x 14'	FB
75914	14' x 20'	FB
87772	3-1/2' x 5'	SS
84537	7' x 10'	SS
84538	10' x 14'	SS
22407	7' x 10'	PL
22408	10' x 14'	PL
40971	7' x 10'	AL
40972	10' x 14'	AL



131913	7' x 10'	FB
131914	10' x 14'	FB
131911	7' x 10'	SS
131912	10' x 14'	SS
131910	7' x 10'	PL
25894	10' x 14'	PL
131909	7' x 10'	AL
43471	10' x 14'	AL



84788	7' x 10'	SS
84789	10' x 14'	SS
25466	7' x 10'	PL
25467	10' x 14'	PL
43043	7' x 10'	AL
43044	10' x 14'	AL



87664	10' x 14'	FB
33656	10' x 14'	SS
33659	10' x 14'	AL



75919	7' x 10'	FB
84790	7' x 10'	SS
84791	10' x 14'	SS
25468	7' x 10'	PL
25469	10' x 14'	PL
43045	7' x 10'	AL
43046	10' x 14'	AL



128558	7' x 10'	SS
128561	10' x 14'	SS
128557	7' x 10'	PL
128560	10' x 14'	PL
128556	7' x 10'	AL
128559	10' x 14'	AL



128570	7' x 10'	SS
128573	10' x 14'	SS
128569	7' x 10'	PL
128572	10' x 14'	PL
128568	7' x 10'	AL
128571	10' x 14'	AL



# Personal Protection Signs

BradyID.com/s34

## Personal Protection Signs (Continued)

Safety Signs



129170	7" x 10"	SS
129173	10" x 14"	SS
129169	7" x 10"	PL
129172	10" x 14"	PL
129168	7" x 10"	AL
129171	10" x 14"	AL



84792	10" x 7"	SS
84793	14" x 10"	SS
25470	10" x 7"	PL
25471	14" x 10"	PL
43047	10" x 7"	AL
43048	14" x 10"	AL



128564	7" x 10"	SS
128567	10" x 14"	SS
128563	7" x 10"	PL
128566	10" x 14"	PL
128562	7" x 10"	AL
128565	10" x 14"	AL



70383	10" x 14"	FB
84794	7" x 10"	SS
84795	10" x 14"	SS
25472	7" x 10"	PL
25473	10" x 14"	PL
43049	7" x 10"	AL
43050	10" x 14"	AL

**Popular Sign Materials**

- FB** - Premium Fiberglass (B-120)
- SS** - Self-Sticking Polyester (B-302)
- BGSS** - BradyGlo™ Self-Sticking Polyester (B-324)
- BGPL** - BradyGlo™ Plastic (B-347)
- PL** - Plastic (B-401)
- AL** - Aluminum (B-555)

*View all sign materials on page 25.*

**Can't find your sign?**  
Use the Sign Legend Index on page 498 or take advantage of our custom sign options.



73461	10" x 14"	FB
84796	7" x 10"	SS
84797	10" x 14"	SS
25474	7" x 10"	PL
25475	10" x 14"	PL
43051	7" x 10"	AL
43052	10" x 14"	AL



69331	10" x 14"	FB
84987	7" x 10"	SS
22588	7" x 10"	PL
22589	10" x 14"	PL
41152	7" x 10"	AL
41153	10" x 14"	AL



128576	7" x 10"	SS
128579	10" x 14"	SS
128575	7" x 10"	PL
128578	10" x 14"	PL
128574	7" x 10"	AL
128577	10" x 14"	AL



128582	7" x 10"	SS
128585	10" x 14"	SS
128581	7" x 10"	PL
128584	10" x 14"	PL
128580	7" x 10"	AL
128583	10" x 14"	AL



70475	10" x 14"	FB
88571	7" x 10"	SS
88572	10" x 14"	SS
25204	7" x 10"	PL
25205	10" x 14"	PL
42781	7" x 10"	AL
42782	10" x 14"	AL



131990	10" x 14"	FB
131989	10" x 14"	SS
131988	10" x 14"	PL
131987	10" x 14"	AL



131997	7" x 10"	FB
131998	10" x 14"	FB
131995	7" x 10"	SS
131996	10" x 14"	SS
131993	7" x 10"	PL
131994	10" x 14"	PL
131991	7" x 10"	AL
131992	10" x 14"	AL



131966	10" x 14"	FB
131965	10" x 14"	SS
131964	10" x 14"	PL
131963	10" x 14"	AL



131974	10" x 14"	FB
131973	10" x 14"	SS
131972	10" x 14"	PL
131971	10" x 14"	AL



131970	10" x 14"	FB
131969	10" x 14"	SS
131968	10" x 14"	PL
131967	10" x 14"	AL



131986	10" x 14"	FB
131985	10" x 14"	SS
131984	10" x 14"	PL
131983	10" x 14"	AL



131982	10" x 14"	FB
131981	10" x 14"	SS
131980	10" x 14"	PL
131979	10" x 14"	AL



131962	10" x 14"	FB
131961	10" x 14"	SS
131960	10" x 14"	PL
131959	10" x 14"	AL



131978	10" x 14"	FB
131977	10" x 14"	SS
131976	10" x 14"	PL
131975	10" x 14"	AL



122846	7" x 10"	FB
73470	10" x 14"	FB
84545	7" x 10"	SS
84546	10" x 14"	SS
22415	7" x 10"	PL
22416	10" x 14"	PL
122410	7" x 10"	AL
40980	10" x 14"	AL



65916	14" x 10"	FB
65917	20" x 14"	FB
84547	14" x 10"	SS
22417	14" x 10"	PL
40981	14" x 10"	AL



131957	7" x 10"	FB
131958	10" x 14"	FB
131955	7" x 10"	SS
131956	10" x 14"	SS
131953	7" x 10"	PL
131954	10" x 14"	PL
131951	7" x 10"	AL
131952	10" x 14"	AL



128588	7" x 10"	SS
128591	10" x 14"	SS
128587	7" x 10"	PL
128590	10" x 14"	PL
128586	7" x 10"	AL
128589	10" x 14"	AL



122847	7" x 10"	FB
70506	10" x 14"	FB
84556	7" x 10"	SS
84557	10" x 14"	SS
22418	7" x 10"	PL
22419	10" x 14"	PL
40982	7" x 10"	AL
40983	10" x 14"	AL



75042	14" x 20"	FB
84989	7" x 10"	SS
84990	10" x 14"	SS
22590	7" x 10"	PL
22591	10" x 14"	PL
41154	7" x 10"	AL
41155	10" x 14"	AL



# Personal Protection Signs

BradyID.com/s34

## Personal Protection Signs (Continued)

 <p><b>CAUTION</b> SAFETY GLASSES REQUIRED BEYOND THIS POINT</p>	 <p><b>CAUTION</b> SAFETY GLASSES REQUIRED IN THIS AREA</p>	 <p><b>CAUTION</b> SAFETY GLASSES WITH SIDE SHIELDS MUST BE WORN IN THIS AREA</p>	 <p><b>CAUTION</b> SAFETY GOGGLES REQUIRED IN THIS AREA</p>	 <p><b>CAUTION</b> SAFETY GOGGLES REQUIRED IN THIS AREA</p>	 <p><b>CAUTION</b> SAFETY SHOES REQUIRED</p>
74630 14" x 20" FB 84991 7" x 10" SS 84992 10" x 14" SS 22592 7" x 10" PL 22593 10" x 14" PL 41156 7" x 10" AL 41157 10" x 14" AL	84993 7" x 10" SS 84994 10" x 14" SS 22594 7" x 10" PL 22595 10" x 14" PL 41158 7" x 10" AL 41159 10" x 14" AL	128594 7" x 10" SS 128597 10" x 14" SS 128593 7" x 10" PL 128596 10" x 14" PL 128592 7" x 10" AL 128595 10" x 14" AL	75976 7" x 10" FB 75977 10" x 14" FB 84995 7" x 10" SS 84996 10" x 14" SS 22596 7" x 10" PL 22597 10" x 14" PL 41160 7" x 10" AL 41161 10" x 14" AL	131919 7" x 10" FB 131920 10" x 14" FB 131917 7" x 10" SS 131918 10" x 14" SS 131916 7" x 10" PL 25895 10" x 14" PL 131915 7" x 10" AL	25895 10" x 14" PL 43472 10" x 14" AL
 <p><b>CAUTION</b> SHARP OBJECTS GLOVES REQUIRED</p>	 <p><b>CAUTION</b> USE HANDRAIL</p>	 <p><b>CAUTION</b> VAPOR RESPIRATOR REQUIRED IN THIS AREA</p>	 <p><b>CAUTION</b> VISITORS MUST WEAR HARD HATS AND SAFETY GLASSES</p>	 <p><b>CAUTION</b> WATCH YOUR STEP</p>	 <p><b>CAUTION</b> WEAR APPROVED BREATHING APPARATUS BEYOND THIS POINT</p>
128600 7" x 10" SS 128603 10" x 14" SS 128599 7" x 10" PL 128602 10" x 14" PL 128598 7" x 10" AL 128601 10" x 14" AL	122767 10" x 14" FB 122455 7" x 10" AL 122383 10" x 14" AL	128606 7" x 10" SS 128609 10" x 14" SS 128605 7" x 10" PL 128608 10" x 14" PL 128604 7" x 10" AL 128607 10" x 14" AL	128612 7" x 10" SS 128615 10" x 14" SS 128611 7" x 10" PL 128614 10" x 14" PL 128610 7" x 10" AL 128613 10" x 14" AL	122836 7" x 10" FB	128660 7" x 10" SS 128663 10" x 14" SS 128659 7" x 10" PL 128662 10" x 14" PL 128658 7" x 10" AL 128661 10" x 14" AL
 <p><b>CAUTION</b> WEAR BREATHING APPARATUS IN THIS AREA</p>	 <p><b>CAUTION</b> WEAR EAR PROTECTION</p>	 <p><b>CAUTION</b> WEAR EAR PROTECTION</p>	 <p><b>CAUTION</b> WEAR EYE PROTECTION</p>	 <p><b>CAUTION</b> WEAR EYE PROTECTION</p>	 <p><b>CAUTION</b> WEAR FACE SHIELD</p>
128666 7" x 10" SS 128669 10" x 14" SS 128665 7" x 10" PL 128668 10" x 14" PL 128664 7" x 10" AL 128667 10" x 14" AL	84798 7" x 10" SS 84799 10" x 14" SS 25476 7" x 10" PL 25477 10" x 14" PL 43053 7" x 10" AL 43054 10" x 14" AL	25908 10" x 14" PL 43485 10" x 14" AL	84997 7" x 10" SS 84998 10" x 14" SS 22599 10" x 14" PL 41162 7" x 10" AL 41163 10" x 14" AL	25909 10" x 14" PL 43486 10" x 14" AL	128648 7" x 10" SS 128651 10" x 14" SS 128647 7" x 10" PL 128650 10" x 14" PL 128646 7" x 10" AL 128649 10" x 14" AL
 <p><b>CAUTION</b> WEAR GLOVES AND GOGGLES</p>	 <p><b>CAUTION</b> WEAR GOGGLES OR FACE SHIELD WHILE OPERATING THIS MACHINE</p>	 <p><b>CAUTION</b> WEAR GOGGLES WHEN USING THIS MACHINE</p>	 <p><b>CAUTION</b> WEAR PROTECTIVE CLOTHING</p>	 <p><b>CAUTION</b> WEAR PROTECTIVE EQUIPMENT</p>	 <p><b>CAUTION</b> WEAR RESPIRATOR WHILE SPRAYING</p>
128636 7" x 10" SS 128639 10" x 14" SS 128635 7" x 10" PL 128638 10" x 14" PL 128634 7" x 10" AL 128637 10" x 14" AL	84999 7" x 10" SS 85000 10" x 14" SS 22600 7" x 10" PL 22601 10" x 14" PL 41164 7" x 10" AL 41165 10" x 14" AL	85001 7" x 10" SS 85002 10" x 14" SS 22602 7" x 10" PL 22603 10" x 14" PL 41166 7" x 10" AL 41167 10" x 14" AL	128630 7" x 10" SS 128633 10" x 14" SS 128629 7" x 10" PL 128632 10" x 14" PL 128628 7" x 10" AL 128631 10" x 14" AL	124255 10" x 7" SS 124258 14" x 10" SS 124254 10" x 7" PL 124257 14" x 10" PL 124253 10" x 7" AL 124256 14" x 10" AL	128654 7" x 10" SS 128657 10" x 14" SS 128653 7" x 10" PL 128656 10" x 14" PL 128652 7" x 10" AL 128655 10" x 14" AL
 <p><b>CAUTION</b> WEAR SAFETY EQUIPMENT</p>	 <p><b>CAUTION</b> WEAR SAFETY SHOES IN THIS AREA</p>	 <p><b>CAUTION</b> WEAR YOUR FALL PROTECTION</p>	 <p><b>CAUTION</b> WEAR YOUR RESPIRATOR</p>	 <p><b>CAUTION</b> SAFETY GLASSES REQUIRED IN THIS AREA</p>	
128642 7" x 10" SS 128645 10" x 14" SS 128641 7" x 10" PL 128644 10" x 14" PL 128640 7" x 10" AL 128643 10" x 14" AL	122837 7" x 10" FB 74740 10" x 14" FB 88583 7" x 10" SS 88584 10" x 14" SS 25206 7" x 10" PL 25207 10" x 14" PL 42783 7" x 10" AL 42784 10" x 14" AL	128672 7" x 10" SS 128675 10" x 14" SS 128671 7" x 10" PL 128674 10" x 14" PL 128670 7" x 10" AL 128673 10" x 14" AL	74764 10" x 14" FB 88585 7" x 10" SS 88586 10" x 14" SS 25208 7" x 10" PL 25209 10" x 14" PL 42785 7" x 10" AL		



# Personal Protection Signs

BradyID.com/s34

## Personal Protection Signs (Continued)



129098	7" x 10"	SS
129101	10" x 14"	SS
129097	7" x 10"	PL
129100	10" x 14"	PL
129096	7" x 10"	AL
129099	10" x 14"	AL



40651	7" x 10"	AL
40652	10" x 14"	AL



128702	7" x 10"	SS
128705	10" x 14"	SS
128701	7" x 10"	PL
128704	10" x 14"	PL
128700	7" x 10"	AL
128703	10" x 14"	AL



70273	10" x 14"	FB
85003	7" x 10"	SS
22605	10" x 14"	PL

**Popular Sign Materials**

**FB** - Premium Fiberglass (B-120)  
**SS** - Self-Sticking Polyester (B-302)  
**BGSS** - BradyGlo™ Self-Sticking Polyester (B-324)  
**BGPL** - BradyGlo™ Plastic (B-347)  
**PL** - Plastic (B-401)  
**AL** - Aluminum (B-555)

*View all sign materials on page 25.*

**Can't find your sign?**  
*Use the Sign Legend Index on page 498 or take advantage of our custom sign options.*



128720	7" x 10"	SS
128723	10" x 14"	SS
128719	7" x 10"	PL
128722	10" x 14"	PL
128718	7" x 10"	AL
128721	10" x 14"	AL



85007	7" x 10"	SS
85008	10" x 14"	SS
22606	7" x 10"	PL
22607	10" x 14"	PL
41170	7" x 10"	AL
41171	10" x 14"	AL



128714	7" x 10"	SS
128717	10" x 14"	SS
128713	7" x 10"	PL
128716	10" x 14"	PL
128712	7" x 10"	AL
128715	10" x 14"	AL



128708	7" x 10"	SS
128711	10" x 14"	SS
128707	7" x 10"	PL
128710	10" x 14"	PL
128706	7" x 10"	AL
128709	10" x 14"	AL



70287	20" x 14"	FB
85011	7" x 10"	SS
22608	10" x 7"	PL
22609	14" x 10"	PL
41172	10" x 7"	AL
41173	14" x 10"	AL



70298	7" x 17"	FB
-------	----------	----



69184	10" x 14"	FB
84802	7" x 10"	SS
84803	10" x 14"	SS
25478	7" x 10"	PL
25479	10" x 14"	PL
43055	7" x 10"	AL
43056	10" x 14"	AL



25896	10" x 14"	PL
43473	10" x 14"	AL



84804	7" x 10"	SS
84805	10" x 14"	SS
25480	7" x 10"	PL
43057	7" x 10"	AL
43058	10" x 14"	AL



73456	10" x 14"	FB
84806	7" x 10"	SS
84807	10" x 14"	SS
25482	7" x 10"	PL
43059	7" x 10"	AL
43060	10" x 14"	AL



85015	7" x 10"	SS
85016	10" x 14"	SS
22612	7" x 10"	PL
22613	10" x 14"	PL
41176	7" x 10"	AL
41177	10" x 14"	AL



128732	7" x 10"	SS
128735	10" x 14"	SS
128731	7" x 10"	PL
128734	10" x 14"	PL
128730	7" x 10"	AL
128733	10" x 14"	AL



128726	7" x 10"	SS
128729	10" x 14"	SS
128725	7" x 10"	PL
128728	10" x 14"	PL
128724	7" x 10"	AL
128727	10" x 14"	AL



128738	7" x 10"	SS
128741	10" x 14"	SS
128737	7" x 10"	PL
128740	10" x 14"	PL
128736	7" x 10"	AL
128739	10" x 14"	AL



128696	7" x 10"	SS
128699	10" x 14"	SS
128695	7" x 10"	PL
128698	10" x 14"	PL
128694	7" x 10"	AL
128697	10" x 14"	AL



129104	7" x 10"	SS
129107	10" x 14"	SS
129103	7" x 10"	PL
129106	10" x 14"	PL
129102	7" x 10"	AL
129105	10" x 14"	AL



47158	7" x 10"	FB
47189	10" x 14"	FB
88611	7" x 10"	SS
88612	10" x 14"	SS
25216	7" x 10"	PL
25217	10" x 14"	PL
42793	7" x 10"	AL
42794	10" x 14"	AL



128744	7" x 10"	SS
128747	10" x 14"	SS
128743	7" x 10"	PL
128746	10" x 14"	PL
128742	7" x 10"	AL
128745	10" x 14"	AL

Safety Signs

## Personal Protection Signs (Continued)



75979	7" x 10"	FB
75980	10" x 14"	FB
42791	7" x 10"	AL
42792	10" x 14"	AL
25214	7" x 10"	PL
25215	10" x 14"	PL
88609	7" x 10"	SS
88610	10" x 14"	SS



128750	7" x 10"	SS
128753	10" x 14"	SS
128749	7" x 10"	PL
128752	10" x 14"	PL
128748	7" x 10"	AL
128751	10" x 14"	AL



123679	7" x 10"	SS
123682	10" x 14"	SS
123678	7" x 10"	PL
123681	10" x 14"	PL
123677	7" x 10"	AL
123680	10" x 14"	AL



128756	7" x 10"	SS
128759	10" x 14"	SS
128755	7" x 10"	PL
128758	10" x 14"	PL
128754	7" x 10"	AL
128757	10" x 14"	AL



128762	7" x 10"	SS
128765	10" x 14"	SS
128761	7" x 10"	PL
128764	10" x 14"	PL
128760	7" x 10"	AL
128763	10" x 14"	AL



128768	7" x 10"	SS
128771	10" x 14"	SS
128767	7" x 10"	PL
128770	10" x 14"	PL
128766	7" x 10"	AL
128769	10" x 14"	AL



128774	7" x 10"	SS
128777	10" x 14"	SS
128773	7" x 10"	PL
128776	10" x 14"	PL
128772	7" x 10"	AL
128775	10" x 14"	AL



69469	10" x 14"	FB
88617	7" x 10"	SS
88618	10" x 14"	SS
25218	7" x 10"	PL
25219	10" x 14"	PL
42795	7" x 10"	AL
42796	10" x 14"	AL



69472	10" x 14"	FB
88619	7" x 10"	SS
88620	10" x 14"	SS
25220	7" x 10"	PL
25221	10" x 14"	PL
42797	7" x 10"	AL
42798	10" x 14"	AL



128780	7" x 10"	SS
128783	10" x 14"	SS
128779	7" x 10"	PL
128782	10" x 14"	PL
128778	7" x 10"	AL
128781	10" x 14"	AL



128786	7" x 10"	SS
128789	10" x 14"	SS
128785	7" x 10"	PL
128788	10" x 14"	PL
128784	7" x 10"	AL
128787	10" x 14"	AL



70515	10" x 14"	FB
87780	3-1/2" x 5"	SS
85017	7" x 10"	SS
85018	10" x 14"	SS
22614	7" x 10"	PL
22615	10" x 14"	PL
41178	7" x 10"	AL



70517	7" x 17"	FB
-------	----------	----



69486	7" x 17"	FB
-------	----------	----



85021	7" x 10"	SS
23049	7" x 10"	PL
22619	10" x 14"	PL



128798	7" x 10"	SS
128801	10" x 14"	SS
128797	7" x 10"	PL
128800	10" x 14"	PL
128796	7" x 10"	AL
128799	10" x 14"	AL



70588	10" x 14"	FB
85027	7" x 10"	SS
85028	10" x 14"	SS
22620	7" x 10"	PL
22621	10" x 14"	PL
41184	7" x 10"	AL



128804	7" x 10"	SS
128807	10" x 14"	SS
128803	7" x 10"	PL
128806	10" x 14"	PL
128802	7" x 10"	AL
128805	10" x 14"	AL



# Personal Protection Signs

BradyID.com/s34

## Personal Protection Signs (Continued)

Safety Signs

**NOTICE**  
ALL EMPLOYEES  
AND VISITORS  
MUST WEAR  
EYE PROTECTION

128810	7" x 10"	SS
128813	10" x 14"	SS
128809	7" x 10"	PL
128812	10" x 14"	PL
128808	7" x 10"	AL
128811	10" x 14"	AL

**NOTICE**  
ALL PERSONNEL  
MUST WEAR  
SAFETY GLASSES  
IN THE PLANT

74948	14" x 20"	FB
85029	7" x 10"	SS
85030	10" x 14"	SS
22622	7" x 10"	PL
22623	10" x 14"	PL
41186	7" x 10"	AL
41187	10" x 14"	AL

**NOTICE**  
CHEMICAL GOGGLES  
MUST BE WORN BEYOND  
THIS POINT

85032	10" x 14"	SS
22624	7" x 10"	PL
22625	10" x 14"	PL
41188	7" x 10"	AL

**NOTICE**  
CLEAN AND STORE  
RESPIRATOR  
AFTER USE

128816	7" x 10"	SS
128819	10" x 14"	SS
128815	7" x 10"	PL
128818	10" x 14"	PL
128814	7" x 10"	AL
128817	10" x 14"	AL

**Popular Sign Materials**  
FB - Premium Fiberglass (B-120)  
SS - Self-Sticking Polyester (B-302)  
BGSS - BradyGlo™ Self-Sticking Polyester (B-324)  
BGPL - BradyGlo™ Plastic (B-347)  
PL - Plastic (B-401)  
AL - Aluminum (B-555)  
*View all sign materials on page 25.*  
**Can't find your sign?**  
*Use the Sign Legend Index on page 498 or take advantage of our custom sign options.*

**NOTICE**  
DO NOT ENTER AREA  
UNLESS WEARING  
PROPER  
SAFETY EQUIPMENT

123577	7" x 10"	SS
123580	10" x 14"	SS
123576	7" x 10"	PL
123579	10" x 14"	PL
123575	7" x 10"	AL
123578	10" x 14"	AL

**NOTICE**  
DO NOT OPERATE THIS  
EQUIPMENT WITHOUT  
EAR PROTECTION

70279	10" x 14"	FB
84808	7" x 10"	SS
84809	10" x 14"	SS
25484	7" x 10"	PL
25485	10" x 14"	PL
43061	7" x 10"	AL
43062	10" x 14"	AL

**NOTICE**  
DUST RESPIRATOR  
MUST BE WORN  
ON THIS JOB

69179	10" x 14"	FB
88641	7" x 10"	SS
25224	7" x 10"	PL
25225	10" x 14"	PL
42801	7" x 10"	AL
42802	10" x 14"	AL

**NOTICE**  
EAR PROTECTION  
MUST BE WORN  
BEYOND THIS POINT

69183	10" x 14"	FB
84810	7" x 10"	SS
84811	10" x 14"	SS
25486	7" x 10"	PL
25487	10" x 14"	PL
43063	7" x 10"	AL
43064	10" x 14"	AL

**NOTICE**  
EAR PROTECTION  
MUST BE WORN  
WHILE WORKING  
AT THIS OPERATION

128822	7" x 10"	SS
128825	10" x 14"	SS
128821	7" x 10"	PL
128824	10" x 14"	PL
128820	7" x 10"	AL
128823	10" x 14"	AL

**NOTICE**  
EAR PROTECTION  
REQUIRED IN THIS  
AREA

84812	7" x 10"	SS
84813	10" x 14"	SS
25488	7" x 10"	PL
25489	10" x 14"	PL
43065	7" x 10"	AL
43066	10" x 14"	AL

**NOTICE**  
EAR PROTECTORS  
REQUIRED WHEN IN  
THIS AREA MORE  
THAN 15 MINUTES

128828	7" x 10"	SS
128831	10" x 14"	SS
128827	7" x 10"	PL
128830	10" x 14"	PL
128826	7" x 10"	AL
128829	10" x 14"	AL

**NOTICE**  
EYE PROTECTION  
MUST BE WORN  
WHEN GRINDING

128834	7" x 10"	SS
128837	10" x 14"	SS
128833	7" x 10"	PL
128836	10" x 14"	PL
128832	7" x 10"	AL
128835	10" x 14"	AL

**NOTICE**  
EYE  
PROTECTION  
REQUIRED

128840	7" x 10"	SS
128843	10" x 14"	SS
128839	7" x 10"	PL
128842	10" x 14"	PL
128838	7" x 10"	AL
128841	10" x 14"	AL

**NOTICE**  
FACE SHIELD  
REQUIRED  
IN THIS AREA

128846	7" x 10"	SS
128849	10" x 14"	SS
128845	7" x 10"	PL
128848	10" x 14"	PL
128844	7" x 10"	AL
128847	10" x 14"	AL

**NOTICE**  
FOLLOW  
FALL PROTECTION  
GUIDELINES  
WHEN WORKING  
BEYOND THIS POINT

128852	7" x 10"	SS
128855	10" x 14"	SS
128851	7" x 10"	PL
128854	10" x 14"	PL
128850	7" x 10"	AL
128853	10" x 14"	AL

**NOTICE**  
HAIR COVERING  
REQUIRED  
IN THIS AREA

128858	7" x 10"	SS
128861	10" x 14"	SS
128857	7" x 10"	PL
128860	10" x 14"	PL
128856	7" x 10"	AL
128859	10" x 14"	AL

**NOTICE**  
HAIR NET  
REQUIRED BEYOND  
THIS POINT

70362	10" x 14"	FB
88643	7" x 10"	SS
88644	10" x 14"	SS
25226	7" x 10"	PL
25227	10" x 14"	PL
42803	7" x 10"	AL
42804	10" x 14"	AL

**NOTICE**  
HAIRNETS  
AND BEARD COVERS  
REQUIRED  
IN THIS AREA

128864	7" x 10"	SS
128867	10" x 14"	SS
128863	7" x 10"	PL
128866	10" x 14"	PL
128862	7" x 10"	AL
128865	10" x 14"	AL

**NOTICE**  
HARD HATS AND  
EYE PROTECTION  
REQUIRED  
IN THIS AREA

128870	7" x 10"	SS
128873	10" x 14"	SS
128869	7" x 10"	PL
128872	10" x 14"	PL
128868	7" x 10"	AL
128871	10" x 14"	AL

**NOTICE**  
HARD HATS  
AND FALL  
PROTECTION  
MUST BE  
WORN  
WHEN WORKING  
ON SCAFFOLDING

128948	10" x 7"	SS
128951	14" x 10"	SS
128947	10" x 7"	PL
128950	14" x 10"	PL
128946	10" x 7"	AL
128949	14" x 10"	AL

**NOTICE**  
HARD HATS  
MUST BE WORN  
IN THIS AREA

70370	10" x 14"	FB
88645	7" x 10"	SS
88646	10" x 14"	SS
25228	7" x 10"	PL
25229	10" x 14"	PL
42806	10" x 14"	AL

**NOTICE**  
HARD HATS MUST BE  
WORN ON THIS  
CONSTRUCTION PROJECT

60579	10" x 14"	SS
60540	10" x 14"	PL
60511	10" x 14"	AL

**NOTICE**  
HARD HATS  
REQUIRED  
IN THIS AREA

70368	10" x 14"	FB
88647	7" x 10"	SS
88648	10" x 14"	SS
25230	7" x 10"	PL
25231	10" x 14"	PL
42807	7" x 10"	AL
42808	10" x 14"	AL

**NOTICE**  
HEARING PROTECTION  
AND SAFETY GLASSES  
MUST BE WORN  
IN THIS AREA

128876	7" x 10"	SS
128879	10" x 14"	SS
128875	7" x 10"	PL
128878	10" x 14"	PL
128874	7" x 10"	AL
128877	10" x 14"	AL

**NOTICE**  
HEARING PROTECTION  
MUST BE WORN  
IN THIS AREA

47305	7" x 10"	FB
47332	10" x 14"	FB
87777	3-1/2" x 5"	SS
84814	7" x 10"	SS
84815	10" x 14"	SS
25490	7" x 10"	PL
25491	10" x 14"	PL
43067	7" x 10"	AL
43068	10" x 14"	AL

**NOTICE**  
HIGH IMPACT  
SAFETY GLASSES  
BEYOND THIS POINT

128882	7" x 10"	SS
128885	10" x 14"	SS
128881	7" x 10"	PL
128884	10" x 14"	PL
128880	7" x 10"	AL
128883	10" x 14"	AL

**NOTICE**  
HIGH NOISE  
AREA WEAR  
EAR PLUGS

84816	7" x 10"	SS
84817	10" x 14"	SS
25493	10" x 14"	PL
43070	10" x 14"	AL

**NOTICE**  
LIFE JACKETS  
MUST BE WORN  
BEYOND THIS POINT

128888	7" x 10"	SS
128891	10" x 14"	SS
128887	7" x 10"	PL
128890	10" x 14"	PL
128886	7" x 10"	AL
128889	10" x 14"	AL

# Personal Protection Signs

BradyID.com/s34

## Personal Protection Signs (Continued)

**NOTICE**  
OPERATOR  
MUST WEAR  
EAR PROTECTION  
IN THIS AREA

84818 7" x 10" SS  
25494 7" x 10" PL  
25495 10" x 14" PL  
43072 10" x 14" AL

**NOTICE**  
PERSONAL  
PROTECTION REQUIRED  
IN THIS AREA

128894 7" x 10" SS  
128897 10" x 14" SS  
128893 7" x 10" PL  
128896 10" x 14" PL  
128892 7" x 10" AL  
128895 10" x 14" AL

**NOTICE**  
PROTECTIVE  
CLOTHING REQUIRED  
IN THIS AREA

70495 10" x 14" FB  
88649 7" x 10" SS  
25232 7" x 10" PL  
25233 10" x 14" PL  
42809 7" x 10" AL  
42810 10" x 14" AL

**NOTICE**  
RESPIRATORS  
MUST BE WORN  
IN THIS AREA

123571 7" x 10" SS  
123574 10" x 14" SS  
123570 7" x 10" PL  
123573 10" x 14" PL  
123569 7" x 10" AL  
123572 10" x 14" AL

**NOTICE**  
RESPIRATORS  
REQUIRED  
IN THIS AREA...



70507 7" x 17" FB

**NOTICE**  
SAFETY  
EQUIPMENT  
STORED HERE

128906 7" x 10" SS  
128909 10" x 14" SS  
128905 7" x 10" PL  
128908 10" x 14" PL  
128904 7" x 10" AL  
128907 10" x 14" AL

**NOTICE**  
SAFETY GLASSES  
AND SAFETY SHOES  
REQUIRED  
IN THIS AREA

128912 7" x 10" SS  
128915 10" x 14" SS  
128911 7" x 10" PL  
128914 10" x 14" PL  
128910 7" x 10" AL  
128913 10" x 14" AL

**NOTICE**  
SAFETY GLASSES  
MUST BE WORN  
WITH FACE SHIELD



128900 7" x 10" SS  
128903 10" x 14" SS  
128899 7" x 10" PL  
128902 10" x 14" PL  
128898 7" x 10" AL  
128901 10" x 14" AL

**NOTICE**  
SAFETY GLASSES  
REQUIRED  
BEYOND THIS POINT

47307 7" x 10" FB  
47334 10" x 14" FB  
87779 3-1/2" x 5" SS  
85035 7" x 10" SS  
85036 10" x 14" SS  
22626 7" x 10" PL  
22627 10" x 14" PL  
41190 7" x 10" AL  
41191 10" x 14" AL

**NOTICE**  
SAFETY GLASSES  
REQUIRED  
IN THIS AREA

47333 10" x 14" FB  
87781 3-1/2" x 5" SS  
85038 10" x 14" SS  
22628 7" x 10" PL  
22629 10" x 14" PL  
41192 7" x 10" AL  
41193 10" x 14" AL

**NOTICE**  
SAFETY GLASSES  
REQUIRED  
IN THIS AREA...



70523 7" x 17" FB

**NOTICE**  
SAFETY GLASSES,  
SAFETY SHOES,  
AND HARD HATS  
REQUIRED  
BEYOND THIS POINT

128918 7" x 10" SS  
128921 10" x 14" SS  
128917 7" x 10" PL  
128920 10" x 14" PL  
128916 7" x 10" AL  
128919 10" x 14" AL

**NOTICE**  
SAFETY SHOES  
REQUIRED  
IN THIS AREA

69487 10" x 14" FB  
88651 7" x 10" SS  
88652 10" x 14" SS  
25234 7" x 10" PL  
25235 10" x 14" PL  
42811 7" x 10" AL  
42812 10" x 14" AL

**NOTICE**  
SAVE YOUR EYES  
WEAR EYE PROTECTION

69494 10" x 14" FB  
85039 7" x 10" SS  
85040 10" x 14" SS  
22630 7" x 10" PL  
22631 10" x 14" PL  
41194 7" x 10" AL  
41195 10" x 14" AL

**NOTICE**  
SHOE COVERS  
REQUIRED

128426 7" x 10" SS  
128429 10" x 14" SS  
128425 7" x 10" PL  
128428 10" x 14" PL  
128424 7" x 10" AL  
128427 10" x 14" AL

**NOTICE**  
SIDE SHIELD  
SAFETY GLASSES  
REQUIRED IN THIS AREA

74337 10" x 14" FB  
85041 7" x 10" SS  
85042 10" x 14" SS  
25570 7" x 10" PL  
25571 10" x 14" PL  
43147 7" x 10" AL  
43148 10" x 14" AL

**NOTICE**  
STEEL  
TOE  
SHOES  
REQUIRED IN THIS AREA



128924 7" x 10" SS  
128927 10" x 14" SS  
128923 7" x 10" PL  
128926 10" x 14" PL  
128922 7" x 10" AL  
128925 10" x 14" AL

**NOTICE**  
USE OF SAFETY BELT AND  
LINE REQUIRED FOR ANY  
WORK BEYOND GUARDED  
STAIRS OR PLATFORM

69546 10" x 14" FB  
85129 7" x 10" SS  
85130 10" x 14" SS  
25626 7" x 10" PL  
25627 10" x 14" PL  
43203 7" x 10" AL  
43204 10" x 14" AL

**NOTICE**  
VISITORS MUST WEAR  
EYE PROTECTION  
BEYOND THIS POINT

128930 7" x 10" SS  
128933 10" x 14" SS  
128929 7" x 10" PL  
128932 10" x 14" PL  
128928 7" x 10" AL  
128931 10" x 14" AL

**NOTICE**  
WEAR FOOT  
PROTECTION

128936 7" x 10" SS  
128939 10" x 14" SS  
128935 7" x 10" PL  
128938 10" x 14" PL  
128934 7" x 10" AL  
128937 10" x 14" AL

**NOTICE**  
WEAR  
HARD HATS

88656 10" x 14" SS  
42816 10" x 14" AL

**NOTICE**  
WEAR  
\* SPLASH GOGGLES  
\* FACE SHIELD  
\* RUBBER GLOVES  
\* APRON  
IN THIS AREA

128942 7" x 10" SS  
128945 10" x 14" SS  
128941 7" x 10" PL  
128944 10" x 14" PL  
128940 7" x 10" AL  
128943 10" x 14" AL

**NOTICE**  
YOU CAN OBTAIN  
A PAIR OF  
SAFETY GOGGLES  
ASK YOUR FOREMAN

73475 10" x 14" FB

**SAFETY FIRST**  
EAR PROTECTION  
IS AVAILABLE  
SEE YOUR SUPERVISOR

69182 10" x 14" FB  
25496 7" x 10" PL

**SAFETY FIRST**  
EMERGENCY  
SHOWER  
EYE BATH

73455 14" x 20" FB  
85045 7" x 10" SS  
85046 10" x 14" SS  
25574 7" x 10" PL  
25575 10" x 14" PL  
43151 7" x 10" AL  
43152 10" x 14" AL

**SAFETY FIRST**  
EYE PROTECTION  
MUST BE WORN  
IN THIS AREA

70336 14" x 20" FB  
85049 7" x 10" SS  
85050 10" x 14" SS  
25576 7" x 10" PL  
25577 10" x 14" PL  
43153 7" x 10" AL  
43154 10" x 14" AL

**SAFETY FIRST**  
EYE PROTECTION  
REQUIRED  
IN THIS AREA

70338 7" x 10" FB  
85051 7" x 10" SS  
85052 10" x 14" SS  
25578 7" x 10" PL  
25579 10" x 14" PL  
43155 7" x 10" AL  
43156 10" x 14" AL

**SAFETY FIRST**  
FOOD PROTECTION  
REQUIRED  
IN THIS AREA

47375 7" x 10" FB  
69255 10" x 14" FB  
88659 7" x 10" SS  
88660 10" x 14" SS  
25241 10" x 14" PL  
42817 7" x 10" AL



# Personal Protection Signs

BradyID.com/s34

## Personal Protection Signs (Continued)

Safety Signs



69215	10" x 14"	FB
88661	7" x 10"	SS
88662	10" x 14"	SS
25243	10" x 14"	PL
42819	7" x 10"	AL
42820	10" x 14"	AL



123829	7" x 10"	SS
123832	10" x 14"	SS
123828	7" x 10"	PL
123831	10" x 14"	PL
123827	7" x 10"	AL
123830	10" x 14"	AL



69481	10" x 14"	FB
88663	7" x 10"	SS
88664	10" x 14"	SS
25244	7" x 10"	PL
25245	10" x 14"	PL
42821	7" x 10"	AL
42822	10" x 14"	AL



128966	7" x 10"	SS
128969	10" x 14"	SS
128965	7" x 10"	PL
128968	10" x 14"	PL
128964	7" x 10"	AL
128967	10" x 14"	AL

**Popular Sign Materials**

**FB** - Premium Fiberglass (B-120)  
**SS** - Self-Sticking Polyester (B-302)  
**BGSS** - BradyGlo™ Self-Sticking Polyester (B-324)  
**BGPL** - BradyGlo™ Plastic (B-347)  
**PL** - Plastic (B-401)  
**AL** - Aluminum (B-555)

*View all sign materials on page 25.*

**Can't find your sign?**  
*Use the Sign Legend Index on page 498 or take advantage of our custom sign options.*



85053	7" x 10"	SS
85054	10" x 14"	SS
25581	10" x 14"	PL
43157	7" x 10"	AL
43158	10" x 14"	AL



122859	7" x 10"	FB
74479	10" x 14"	FB
85055	7" x 10"	SS
85056	10" x 14"	SS
122526	7" x 10"	PL
25583	10" x 14"	PL
43159	7" x 10"	AL
43160	10" x 14"	AL



128954	7" x 10"	SS
128957	10" x 14"	SS
128953	7" x 10"	PL
128956	10" x 14"	PL
128952	7" x 10"	AL
128955	10" x 14"	AL



128960	10" x 7"	SS
128963	14" x 10"	SS
128959	10" x 7"	PL
128962	14" x 10"	PL
128958	10" x 7"	AL
128961	14" x 10"	AL



128972	7" x 10"	SS
128975	10" x 14"	SS
128971	7" x 10"	PL
128974	10" x 14"	PL
128970	7" x 10"	AL
128973	10" x 14"	AL



69579	10" x 14"	FB
84822	7" x 10"	SS
84823	10" x 14"	SS
25498	7" x 10"	PL
25499	10" x 14"	PL
43075	7" x 10"	AL
43076	10" x 14"	AL



128978	7" x 10"	SS
128981	10" x 14"	SS
128977	7" x 10"	PL
128980	10" x 14"	PL
128976	7" x 10"	AL
128979	10" x 14"	AL



128984	7" x 10"	SS
128987	10" x 14"	SS
128983	7" x 10"	PL
128986	10" x 14"	PL
128982	7" x 10"	AL
128985	10" x 14"	AL



69581	10" x 14"	FB
85057	7" x 10"	SS
85058	10" x 14"	SS
25584	7" x 10"	PL
25585	10" x 14"	PL
43161	7" x 10"	AL
43162	10" x 14"	AL



129134	7" x 10"	SS
129137	10" x 14"	SS
129133	7" x 10"	PL
129136	10" x 14"	PL
129132	7" x 10"	AL
129135	10" x 14"	AL



69584	10" x 14"	FB
88669	7" x 10"	SS
88670	10" x 14"	SS
25246	7" x 10"	PL
25247	10" x 14"	PL
42823	7" x 10"	AL
42824	10" x 14"	AL



128990	7" x 10"	SS
128993	10" x 14"	SS
128989	7" x 10"	PL
128992	10" x 14"	PL
128988	7" x 10"	AL
128991	10" x 14"	AL



128996	7" x 10"	SS
128999	10" x 14"	SS
128995	7" x 10"	PL
128998	10" x 14"	PL
128994	7" x 10"	AL
128997	10" x 14"	AL



129002	7" x 10"	SS
129005	10" x 14"	SS
129001	7" x 10"	PL
129004	10" x 14"	PL
129000	7" x 10"	AL
129003	10" x 14"	AL



129008	7" x 10"	SS
129011	10" x 14"	SS
129007	7" x 10"	PL
129010	10" x 14"	PL
129006	7" x 10"	AL
129009	10" x 14"	AL



129020	7" x 10"	SS
129023	10" x 14"	SS
129019	7" x 10"	PL
129022	10" x 14"	PL
129018	7" x 10"	AL
129021	10" x 14"	AL



129014	7" x 10"	SS
129017	10" x 14"	SS
129013	7" x 10"	PL
129016	10" x 14"	PL
129012	7" x 10"	AL
129015	10" x 14"	AL



90720	10" x 14"	BGPL
-------	-----------	------



85066	3-1/2" x 10"	SS
-------	--------------	----



90649	10" x 7"	BGPL
90731	10" x 14"	BGPL



90139	10" x 7"	BGSS
90650	10" x 7"	BGPL
90732	10" x 14"	BGPL



90121	7" x 10"	BGSS
-------	----------	------



69799	7" x 7"	FB
84551	2-1/4" x 2-1/4"	SS
88495	7" x 7"	SS
25161	7" x 10"	PL
42738	7" x 10"	AL



# Personal Protection Signs

BradyID.com/s34

## Personal Protection Signs (Continued)

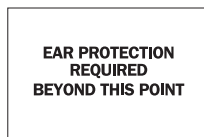

73410	10" x 14"	FB
84824	7" x 10"	SS
84825	10" x 14"	SS
43078	10" x 14"	AL



128462	7" x 10"	SS
128465	10" x 14"	SS
128461	7" x 10"	PL
128464	10" x 14"	PL
128460	7" x 10"	AL
128463	10" x 14"	AL



69800	7" x 7"	FB
25166	7" x 10"	PL
42743	7" x 10"	AL



84549	2-1/4" x 2-1/4"	SS
-------	-----------------	----



90196	10" x 14"	BGSS
90645	10" x 7"	BGPL
90727	10" x 14"	BGPL



90644	10" x 7"	BGPL
90726	10" x 14"	BGPL



85069	3-1/2" x 10"	SS
-------	--------------	----



74982	10" x 14"	FB
25589	7" x 10"	PL

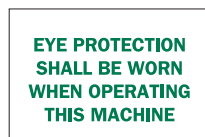

74170	7" x 10"	FB
85070	7" x 10"	SS
85071	10" x 14"	SS
25591	7" x 10"	PL
25592	10" x 14"	PL
43168	7" x 10"	AL



84552	2-1/4" x 2-1/4"	SS
-------	-----------------	----



90960	7" x 10"	BGPL
-------	----------	------



128468	7" x 10"	SS
128471	10" x 14"	SS
128467	7" x 10"	PL
128470	10" x 14"	PL
128466	7" x 10"	AL
128469	10" x 14"	AL



84550	2-1/4" x 2-1/4"	SS
-------	-----------------	----



84555	2-1/4" x 2-1/4"	SS
-------	-----------------	----



128474	7" x 10"	SS
128477	10" x 14"	SS
128473	7" x 10"	PL
128476	10" x 14"	PL
128472	7" x 10"	AL
128475	10" x 14"	AL



70366	10" x 14"	FB
88677	7" x 10"	SS
88678	10" x 14"	SS
25248	7" x 10"	PL
42826	10" x 14"	AL



69006	7" x 7"	FB
88511	7" x 7"	SS
25175	7" x 10"	PL
42752	7" x 10"	AL



60573	10" x 14"	SS
25899	10" x 14"	PL
43476	10" x 14"	AL



84548	2-1/4" x 2-1/4"	SS
-------	-----------------	----



128480	7" x 10"	SS
128483	10" x 14"	SS
128479	7" x 10"	PL
128482	10" x 14"	PL
128478	7" x 10"	AL
128481	10" x 14"	AL



128486	7" x 10"	SS
128489	10" x 14"	SS
128485	7" x 10"	PL
128488	10" x 14"	PL
128484	7" x 10"	AL
128487	10" x 14"	AL



90723	10" x 14"	BGPL
-------	-----------	------



84826	3-1/2" x 10"	SS
-------	--------------	----



124624	5" x 14"	SS
124623	5" x 14"	PL
124622	5" x 14"	AL



90584	5" x 14"	BGSS
-------	----------	------



128492	7" x 10"	SS
128495	10" x 14"	SS
128491	7" x 10"	PL
128494	10" x 14"	PL
128490	7" x 10"	AL
128493	10" x 14"	AL



# Personal Protection Signs

BradyID.com/s34

## Personal Protection Signs (Continued)



123823	10" x 7"	SS
123826	14" x 10"	SS
123822	10" x 7"	PL
123825	14" x 10"	PL
123821	10" x 7"	AL
123824	14" x 10"	AL



90587	5" x 14"	BGSS
90785	5" x 14"	BGPL



84554	2-1/4" x 2-1/4"	SS
-------	-----------------	----



69470	7" x 7"	FB
88525	7" x 7"	SS
25186	7" x 10"	PL
42763	7" x 10"	AL

### Popular Sign Materials

- FB** - Premium Fiberglass (B-120)
- SS** - Self-Sticking Polyester (B-302)
- BGSS** - BradyGlo™ Self-Sticking Polyester (B-324)
- BGPL** - BradyGlo™ Plastic (B-347)
- PL** - Plastic (B-401)
- AL** - Aluminum (B-555)

View all sign materials on page 25.

### Can't find your sign?

Use the Sign Legend Index on page 498 or take advantage of our custom sign options.



128498	7" x 10"	SS
128501	10" x 14"	SS
128497	7" x 10"	PL
128500	10" x 14"	PL
128496	7" x 10"	AL
128499	10" x 14"	AL



90112	7" x 10"	BGSS
-------	----------	------



84553	2-1/4" x 2-1/4"	SS
-------	-----------------	----



88527	7" x 7"	SS
25188	7" x 10"	PL
42765	7" x 10"	AL



128678	18" x 18"	SS
128681	24" x 24"	SS
128677	18" x 18"	PL
128680	24" x 24"	PL
128676	18" x 18"	AL
128679	24" x 24"	AL



128690	18" x 18"	SS
128693	24" x 24"	SS
128689	18" x 18"	PL
128692	24" x 24"	PL
128688	18" x 18"	AL
128691	24" x 24"	AL



128684	18" x 18"	SS
128687	24" x 24"	SS
128683	18" x 18"	PL
128686	24" x 24"	PL
128682	18" x 18"	AL
128685	24" x 24"	AL



90722	14" x 10"	BGPL
-------	-----------	------



90646	14" x 10"	BGPL
-------	-----------	------



85072	3-1/2" x 10"	SS
-------	--------------	----



85076	3-1/2" x 10"	SS
-------	--------------	----



90643	10" x 7"	BGPL
90725	14" x 10"	BGPL



90128	10" x 7"	BGSS
90721	14" x 10"	BGPL



85074	3-1/2" x 10"	SS
-------	--------------	----



85075	3-1/2" x 10"	SS
-------	--------------	----



90729	14" x 10"	BGPL
-------	-----------	------



90199	14" x 10"	BGSS
-------	-----------	------



128504	7" x 10"	SS
128507	10" x 14"	SS
128503	7" x 10"	PL
128506	10" x 14"	PL
128502	7" x 10"	AL
128505	10" x 14"	AL



128510	7" x 10"	SS
128513	10" x 14"	SS
128509	7" x 10"	PL
128512	10" x 14"	PL
128508	7" x 10"	AL
128511	10" x 14"	AL



## Radiation & Laser Signs

Brady radiation signs can help you comply with OSHA's regulations for radiation safety and laser warnings. These radiation signs offer messages for radiation danger, microwave warning signs and other radioactive warning safety signs. Radiation signs can be placed around your facility where radiation and x-ray safety are concerns.



### OSHA Regulations

#### Radioactive Area 1910.1096(e)(2)

Each radiation area shall be conspicuously posted with a sign or signs bearing the radiation caution symbol described in subparagraph (1) of this paragraph and the words: CAUTION RADIATION AREA.

#### High Radiation Area 1910.1096(e)(3)(i)

Each high radiation area shall be conspicuously posted with a sign or signs bearing the radiation caution symbol and the words: CAUTION HIGH RADIATION AREA



129158	7' x 10'	SS
129161	10' x 14'	SS
129157	7' x 10'	PL
129160	10' x 14'	PL
129156	7' x 10'	AL
129159	10' x 14'	AL



129278	10' x 7'	SS
129281	14' x 10'	SS
129277	10' x 7'	PL
129280	14' x 10'	PL
129276	10' x 7'	AL
129279	14' x 10'	AL



129242	7' x 10'	SS
129245	10' x 14'	SS
129241	7' x 10'	PL
129244	10' x 14'	PL
129240	7' x 10'	AL
129243	10' x 14'	AL



88691	7' x 10'	SS
25254	7' x 10'	PL
25255	10' x 14'	PL



129164	7' x 10'	SS
129167	10' x 14'	SS
129163	7' x 10'	PL
129166	10' x 14'	PL
129162	7' x 10'	AL
129165	10' x 14'	AL



129176	7' x 10'	SS
129179	10' x 14'	SS
129175	7' x 10'	PL
129178	10' x 14'	PL
129174	7' x 10'	AL
129177	10' x 14'	AL



76082	10' x 14'	FB
88699	7' x 10'	SS
88700	10' x 14'	SS
25256	7' x 10'	PL
25257	10' x 14'	PL
42833	7' x 10'	AL
42834	10' x 14'	AL



88702	10' x 14'	SS
-------	-----------	----

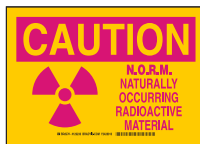

129236	7' x 10'	SS
129239	10' x 14'	SS
129235	7' x 10'	PL
129238	10' x 14'	PL
129234	7' x 10'	AL
129237	10' x 14'	AL



129230	7' x 10'	SS
129233	10' x 14'	SS
129229	7' x 10'	PL
129232	10' x 14'	PL
129228	7' x 10'	AL
129231	10' x 14'	AL



129182	7' x 10'	SS
129185	10' x 14'	SS
129181	7' x 10'	PL
129184	10' x 14'	PL
129180	7' x 10'	AL
129183	10' x 14'	AL



129248	7' x 10'	SS
129251	10' x 14'	SS
129247	7' x 10'	PL
129250	10' x 14'	PL
129246	7' x 10'	AL
129249	10' x 14'	AL



129188	7' x 10'	SS
129191	10' x 14'	SS
129187	7' x 10'	PL
129190	10' x 14'	PL
129186	7' x 10'	AL
129189	10' x 14'	AL



62950	10' x 14'	FB
62954	10' x 14'	SS
62951	7' x 10'	PL
62952	10' x 14'	PL
67992	10' x 14'	AL



129260	7' x 10'	SS
129263	10' x 14'	SS
129259	7' x 10'	PL
129262	10' x 14'	PL
129258	7' x 10'	AL
129261	10' x 14'	AL



42835	7' x 10'	AL
42836	10' x 14'	AL
88707	7' x 10'	SS
88708	10' x 14'	SS
25258	7' x 10'	PL
25259	10' x 14'	PL



70416	10' x 14'	FB
88709	7' x 10'	SS
88710	10' x 14'	SS
25260	7' x 10'	PL
25261	10' x 14'	PL
42837	7' x 10'	AL
42838	10' x 14'	AL



129266	7' x 10'	SS
129269	10' x 14'	SS
129265	7' x 10'	PL
129268	10' x 14'	PL
129264	7' x 10'	AL
129267	10' x 14'	AL



25263	10' x 14'	PL
42840	10' x 14'	AL



129254	7' x 10'	SS
129257	10' x 14'	SS
129253	7' x 10'	PL
129256	10' x 14'	PL
129252	7' x 10'	AL
129255	10' x 14'	AL



76081	10' x 14'	FB
88715	7' x 10'	SS
25264	7' x 10'	PL
25265	10' x 14'	PL
42841	7' x 10'	AL
42842	10' x 14'	AL



88717	7' x 10'	SS
88718	10' x 14'	SS
25266	7' x 10'	PL
25267	10' x 14'	PL
42843	7' x 10'	AL



88725	7' x 10'	SS
88726	10' x 14'	SS
25268	7' x 10'	PL
25269	10' x 14'	PL
42845	7' x 10'	AL
42846	10' x 14'	AL



# Radiation & Laser Signs

BradyID.com/s34

## Radiation & Laser Signs (Continued)



129272	7" x 10"	SS
129275	10" x 14"	SS
129271	7" x 10"	PL
129274	10" x 14"	PL
129270	7" x 10"	AL
129273	10" x 14"	AL



129284	7" x 10"	SS
129287	10" x 14"	SS
129283	7" x 10"	PL
129286	10" x 14"	PL
129282	7" x 10"	AL
129285	10" x 14"	AL



129290	7" x 10"	SS
129293	10" x 14"	SS
129289	7" x 10"	PL
129292	10" x 14"	PL
129288	7" x 10"	AL
129291	10" x 14"	AL



129296	7" x 10"	SS
129299	10" x 14"	SS
129295	7" x 10"	PL
129298	10" x 14"	PL
129294	7" x 10"	AL
129297	10" x 14"	AL

**Popular Sign Materials**

**FB** - Premium Fiberglass (B-120)  
**SS** - Self-Sticking Polyester (B-302)  
**BGSS** - BradyGlo™ Self-Sticking Polyester (B-324)  
**BGPL** - BradyGlo™ Plastic (B-347)  
**PL** - Plastic (B-401)  
**AL** - Aluminum (B-555)

*View all sign materials on page 25.*

---

**Can't find your sign?**  
*Use the Sign Legend Index on page 498 or take advantage of our custom sign options.*



129302	7" x 10"	SS
129305	10" x 14"	SS
129301	7" x 10"	PL
129304	10" x 14"	PL
129300	7" x 10"	AL
129303	10" x 14"	AL



69437	10" x 14"	FB
84583	7" x 10"	SS
22443	7" x 10"	PL
41007	7" x 10"	AL
41008	10" x 14"	AL



129308	10" x 7"	SS
129311	14" x 10"	SS
129307	10" x 7"	PL
129310	14" x 10"	PL
129306	10" x 7"	AL
129309	14" x 10"	AL



84586	10" x 14"	SS
22445	7" x 10"	PL
22446	10" x 14"	PL



129320	7" x 10"	SS
129323	10" x 14"	SS
129319	7" x 10"	PL
129322	10" x 14"	PL
129318	7" x 10"	AL
129321	10" x 14"	AL



129314	10" x 7"	SS
129317	14" x 10"	SS
129313	10" x 7"	PL
129316	14" x 10"	PL
129312	10" x 7"	AL
129315	14" x 10"	AL



129326	7" x 10"	SS
129329	10" x 14"	SS
129325	7" x 10"	PL
129328	10" x 14"	PL
129324	7" x 10"	AL
129327	10" x 14"	AL



129332	7" x 10"	SS
129335	10" x 14"	SS
129331	7" x 10"	PL
129334	10" x 14"	PL
129330	7" x 10"	AL
129333	10" x 14"	AL



129338	7" x 10"	SS
129341	10" x 14"	SS
129337	7" x 10"	PL
129340	10" x 14"	PL
129336	7" x 10"	AL
129339	10" x 14"	AL

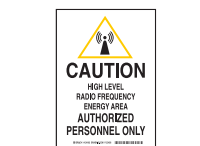

124183	10" x 7"	SS
124186	14" x 10"	SS
124182	10" x 7"	PL
124185	14" x 10"	PL
124181	10" x 7"	AL
124184	14" x 10"	AL



124300	10" x 7"	SS
124303	14" x 10"	SS
124299	10" x 7"	PL
124302	14" x 10"	PL
124298	10" x 7"	AL
124301	14" x 10"	AL



88731	7" x 10"	SS
25270	7" x 10"	PL



88733	10" x 7"	SS
88734	14" x 10"	SS
25272	10" x 7"	PL
25273	14" x 10"	PL
42849	10" x 7"	AL
42850	14" x 10"	AL



88736	7" x 10"	SS
88737	10" x 14"	SS
25274	7" x 10"	PL
25275	10" x 14"	PL



122777	10" x 7"	FB
74829	14" x 10"	FB
88738	10" x 7"	SS
88739	14" x 10"	SS
25276	10" x 7"	PL
25277	14" x 10"	PL
42853	10" x 7"	AL
42854	14" x 10"	AL



74837	7" x 10"	FB
88741	7" x 10"	SS
88742	10" x 14"	SS
25278	7" x 10"	PL
25279	10" x 14"	PL
42855	7" x 10"	AL
42856	10" x 14"	AL



88740	3-1/2" x 10"	SS
-------	--------------	----



74844	14" x 20"	FB
88743	7" x 10"	SS
25280	7" x 10"	PL
25281	10" x 14"	PL
42857	7" x 10"	AL
42858	10" x 14"	AL



124231	10" x 7"	SS
124234	14" x 10"	SS
124230	10" x 7"	PL
124233	14" x 10"	PL
124229	10" x 7"	AL
124232	14" x 10"	AL



74850	14" x 20"	FB
88746	7" x 10"	SS
88747	10" x 14"	SS
25282	7" x 10"	PL
25283	10" x 14"	PL
42859	7" x 10"	AL
42860	10" x 14"	AL



89112	2-1/4" x 2-1/4"	SS
88750	3-1/2" x 10"	SS
88751	5" x 14"	SS



74855	7" x 10"	FB
122717	10" x 14"	FB
88748	7" x 10"	SS
88749	10" x 14"	SS
25284	7" x 10"	PL
25285	10" x 14"	PL
42861	7" x 10"	AL
42862	10" x 14"	AL



88745	2-1/4" x 2-1/4"	SS
-------	-----------------	----



89171	2-1/4" x 2-1/4"	SS
88752	3-1/2" x 10"	SS

## Radiation & Laser Signs (Continued)



74900	14" x 20"	FB
25286	7" x 10"	PL
42863	7" x 10"	AL



74886	5" x 14"	FB
122849	7" x 10"	FB
122719	10" x 14"	FB
88762	5" x 14"	SS
122653	7" x 10"	SS
122578	10" x 14"	SS
122522	7" x 10"	PL
25288	10" x 14"	PL
42865	10" x 14"	AL



88767	7" x 10"	SS
88768	10" x 14"	SS
25289	7" x 10"	PL
74907	7" x 10"	FB
42867	10" x 14"	AL



129200	7" x 10"	SS
129203	10" x 14"	SS
129199	7" x 10"	PL
129202	10" x 14"	PL
129198	7" x 10"	AL
129201	10" x 14"	AL



88769	10" x 7"	SS
88770	14" x 10"	SS
25291	10" x 7"	PL
25292	14" x 10"	PL
42868	10" x 7"	AL
42869	14" x 10"	AL



88936	2-1/4" x 9"	SS
88937	3-1/2" x 10"	SS
88938	5" x 14"	SS



129206	10" x 7"	SS
129209	14" x 10"	SS
129205	10" x 7"	PL
129208	14" x 10"	PL
129204	10" x 7"	AL
129207	14" x 10"	AL



129212	10" x 7"	SS
129215	14" x 10"	SS
129211	10" x 7"	PL
129214	14" x 10"	PL
129210	10" x 7"	AL
129213	14" x 10"	AL



129218	10" x 7"	SS
129221	14" x 10"	SS
129217	10" x 7"	PL
129220	14" x 10"	PL
129216	10" x 7"	AL
129219	14" x 10"	AL



129224	7" x 10"	SS
129227	10" x 14"	SS
129223	7" x 10"	PL
129226	10" x 14"	PL
129222	7" x 10"	AL
129225	10" x 14"	AL



129344	18" x 18"	SS
129343	18" x 18"	PL
129342	18" x 18"	AL

## Nuclear-Insert Signs

- Insert signs capable of holding multiple messages
- Durable subsurface printed on polycarbonate material
- Sharply contrasting magenta on yellow "Caution" header with radiation symbol
- Thumb notch at pocket opening allows for easy removal of the insert
- Snap-in "dimple" design holds inserts lightly
- Available with nylon clamps for hanging or brass grommets for wall mounting

Catalog #	Size	Description	Qty/Pkg
(See Below)	1-11/16" x 8"	Polycarbonate Sign Inserts (Legends Below)	5
93600	12" x 8"	3-Pocket "Caution" Insert Holder	1
93602	16" x 8"	5-Pocket "Caution" Insert Holder	1



Nuclear-Insert Signs provide precise hazard warning by enabling you to include up to 5 messages per sign.



93634 1-11/16" x 8"



93620 1-11/16" x 8"



93636 1-11/16" x 8"



93625 1-11/16" x 8"



93637 1-11/16" x 8"



93619 1-11/16" x 8"



93629 1-11/16" x 8"



93631 1-11/16" x 8"



93640 1-11/16" x 8"



93627 1-11/16" x 8"



93616 1-11/16" x 8"



93638 1-11/16" x 8"



93621 1-11/16" x 8"



93611 1-11/16" x 8"



# Recycle & Environment

BradyID.com/s34

## Recycle & Environment Signs

Brady offers a full line of recycling signs for an environmentally responsible facility. Recycle signs can be placed in designated areas for recycling.

### Popular Sign Materials

- FB** - Premium Fiberglass (B-120)
- SS** - Self-Sticking Polyester (B-302)
- SSV** - Self-Sticking Vinyl (B-946)
- BGSS** - BradyGlo™ Self-Sticking Polyester (B-324)
- BGPL** - BradyGlo™ Plastic (B-347)
- PL** - Plastic (B-401)
- AL** - Aluminum (B-555)

View all sign materials on page 25.

### Can't find your sign?

Use the Sign Legend Index on page 194 or take advantage of our custom sign options.

Safety Signs



73478	10" x 14"	FB
86023	7" x 10"	SS
86024	10" x 14"	SS
25943	7" x 10"	PL
25944	10" x 14"	PL



129389	10" x 7"	SS
129392	14" x 10"	SS
129388	10" x 7"	PL
129391	14" x 10"	PL
129387	10" x 7"	AL
129390	14" x 10"	AL



86027	7" x 10"	SS
25947	7" x 10"	PL
41972	7" x 10"	AL



129353	10" x 7"	SS
129356	14" x 10"	SS
129352	10" x 7"	PL
129355	14" x 10"	PL
129351	10" x 7"	AL
129354	14" x 10"	AL



129359	10" x 7"	SS
129362	14" x 10"	SS
129358	10" x 7"	PL
129361	14" x 10"	PL
129357	10" x 7"	AL
129360	14" x 10"	AL



129365	10" x 7"	SS
129368	14" x 10"	SS
129364	10" x 7"	PL
129367	14" x 10"	PL
129363	10" x 7"	AL
129366	14" x 10"	AL



129347	7" x 10"	SS
129350	10" x 14"	SS
129346	7" x 10"	PL
129349	10" x 14"	PL
129345	7" x 10"	AL
129348	10" x 14"	AL



129371	10" x 7"	SS
129374	14" x 10"	SS
129370	10" x 7"	PL
129373	14" x 10"	PL
129369	10" x 7"	AL
129372	14" x 10"	AL



123516	7" x 10"	SS
123519	10" x 14"	SS
123515	7" x 10"	PL
123518	10" x 14"	PL
123514	7" x 10"	AL
123517	10" x 14"	AL



76879	12" x 12"	FB
22451	7" x 10"	PL



123947	7" x 10"	SS
123950	10" x 14"	SS
123946	7" x 10"	PL
123949	10" x 14"	PL
123945	7" x 10"	AL
123948	10" x 14"	AL



123559	10" x 7"	SS
123562	14" x 10"	SS
123558	10" x 7"	PL
123561	14" x 10"	PL
123557	10" x 7"	AL
123560	14" x 10"	AL

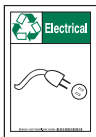

129377	10" x 7"	SS
129380	14" x 10"	SS
129376	10" x 7"	PL
129379	14" x 10"	PL
129375	10" x 7"	AL
129378	14" x 10"	AL

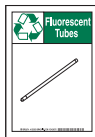

129383	10" x 7"	SS
129386	14" x 10"	SS
129382	10" x 7"	PL
129385	14" x 10"	PL
129381	10" x 7"	AL
129384	14" x 10"	AL



86025	7" x 10"	SS
25945	7" x 10"	PL
25946	10" x 14"	PL



129395	10" x 7"	SS
129398	14" x 10"	SS
129394	10" x 7"	PL
129397	14" x 10"	PL
129393	10" x 7"	AL
129396	14" x 10"	AL



86029	7" x 10"	SS
25950	10" x 14"	PL



123967	10" x 7"	SS
123970	14" x 10"	SS
123966	10" x 7"	PL
123969	14" x 10"	PL
123965	10" x 7"	AL
123968	14" x 10"	AL



73477	10" x 14"	FB
86013	7" x 10"	SS
86014	10" x 14"	SS
25933	7" x 10"	PL
25934	10" x 14"	PL
41959	10" x 14"	AL



73426	7" x 10"	FB
70612	10" x 14"	FB
86011	7" x 10"	SS
86012	10" x 14"	SS
41956	7" x 10"	AL



70617	7" x 10"	FB
86018	10" x 14"	SS
41963	10" x 14"	AL



70609	7" x 10"	FB
70610	10" x 14"	FB
86009	7" x 10"	SS
86010	10" x 14"	SS
25929	7" x 10"	PL
25930	10" x 14"	PL



70608	10" x 14"	FB
86007	7" x 10"	SS
86008	10" x 14"	SS
25927	7" x 10"	PL
25928	10" x 14"	PL
41952	7" x 10"	AL
41953	10" x 14"	AL



84601	10" x 14"	SS
-------	-----------	----



84602	10" x 14"	SS
-------	-----------	----



84603	10" x 14"	SS
-------	-----------	----



84604	10" x 14"	SS
-------	-----------	----



70616	10" x 14"	FB
86015	7" x 10"	SS
86016	10" x 14"	SS
25936	10" x 14"	PL
41961	10" x 14"	AL



123961	10" x 7"	SS
123964	14" x 10"	SS
123960	10" x 7"	PL
123963	14" x 10"	PL
123959	10" x 7"	AL
123962	14" x 10"	AL

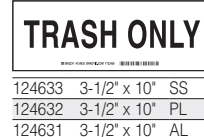

124633	3-1/2" x 10"	SS
124632	3-1/2" x 10"	PL
124631	3-1/2" x 10"	AL

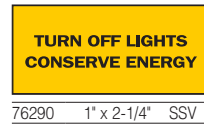

76290	1" x 2-1/4"	SSV
-------	-------------	-----

84605	10" x 14"	SS
-------	-----------	----

## Restroom Signs

Brady's restroom signs easily identify your facility's restrooms. These restroom signs feature bold lettering and universal pictograms. Brady has over 20 different pictogram and stock legends for restroom signs in various sizes, color, languages and materials, including restroom signs that identify handicap access.



129401	10" x 7"	SS
129404	14" x 10"	SS
129400	10" x 7"	PL
129403	14" x 10"	PL
129399	10" x 7"	AL
129402	14" x 10"	AL



123979	7" x 10"	SS
123982	10" x 14"	SS
123978	7" x 10"	PL
123981	10" x 14"	PL
123977	7" x 10"	AL
123980	10" x 14"	AL



123985	7" x 10"	SS
123988	10" x 14"	SS
123984	7" x 10"	PL
123987	10" x 14"	PL
123983	7" x 10"	AL
123986	10" x 14"	AL



123973	7" x 10"	SS
123976	10" x 14"	SS
123972	7" x 10"	PL
123975	10" x 14"	PL
123971	7" x 10"	AL
123974	10" x 14"	AL



84234	3-1/2" x 10"	SS
-------	--------------	----



132100	7" x 10"	FB
47668	7" x 10"	SS
47670	7" x 10"	PL
47671	7" x 10"	AL



47699	7" x 10"	SS
47701	7" x 10"	PL
47708	7" x 10"	AL



47725	10" x 7"	SS
47727	10" x 7"	PL
47728	10" x 7"	AL



88516	7" x 7"	SS
25178	7" x 10"	PL
42755	7" x 10"	AL



70426	4" x 12"	FB
-------	----------	----



25917	10" x 14"	PL
43493	10" x 14"	AL



124639	3-1/2" x 10"	SS
124638	3-1/2" x 10"	PL
124637	3-1/2" x 10"	AL



124636	3-1/2" x 10"	SS
124635	3-1/2" x 10"	PL
124634	3-1/2" x 10"	AL



47685	7" x 10"	SS
47690	7" x 10"	PL
47691	7" x 10"	AL



70508	4" x 12"	FB
-------	----------	----



25918	10" x 14"	PL
43494	10" x 14"	AL



91319	6" x 12"	FB
89128	6" x 12"	SS



123881	7" x 10"	SS
123884	10" x 14"	SS
123880	7" x 10"	PL
123883	10" x 14"	PL
123879	7" x 10"	AL
123882	10" x 14"	AL



87719	10" x 14"	FB
47538	10" x 14"	SS
47551	10" x 14"	PL
47555	10" x 14"	AL



87718	10" x 14"	FB
47546	10" x 14"	SS
47540	10" x 14"	PL



132101	7" x 10"	FB
47674	7" x 10"	SS
47676	7" x 10"	PL
47677	7" x 10"	AL



47713	7" x 10"	SS
47721	7" x 10"	PL
47722	7" x 10"	AL



47731	10" x 7"	SS
47733	10" x 7"	PL
47734	10" x 7"	AL



88530	7" x 7"	SS
25191	7" x 10"	PL
42768	7" x 10"	AL

**Braille (ADA) Restroom Signs Also Available!**

Brady also offers restroom signs that comply with requirements set under the Americans with Disabilities Act (ADA). These signs feature a true dome-shaped Braille dot to meet ICC / ANSI 117.1 specifications.

View page 63 for all Braille Signs.



70593	4" x 12"	FB
-------	----------	----



25919	10" x 14"	PL
43495	10" x 14"	AL



# Safety Banners

BradyID.com/s34

## Safety Banners

Brady safety banners promote and motivate employees on the importance of workplace safety and preparedness. These safety banners are large, highly visible and can be hung throughout your facility to visually remind employees about safe work practices. Made of a heavy-duty polyethylene, Brady safety banners can withstand tough, industrial work environments and can be easily hung from workplace walls or ceilings.

### Banner Material

Banners are constructed of heavy duty 10 mil vinyl and are recommended for indoor use only.

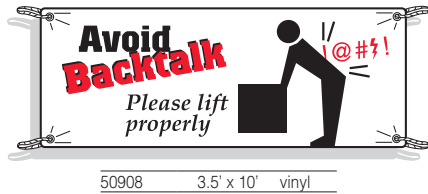
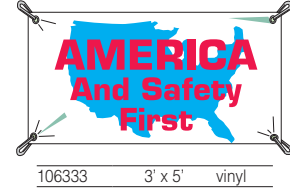
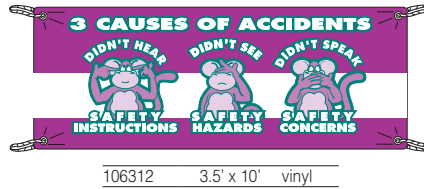
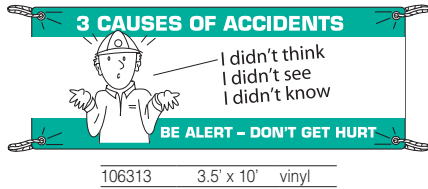



## Safety Banners (Continued)



106324 3.5' x 10' vinyl



106325 3.5' x 10' vinyl



106327 3.5' x 10' vinyl



106328 3.5' x 10' vinyl



56970 3' x 5' vinyl

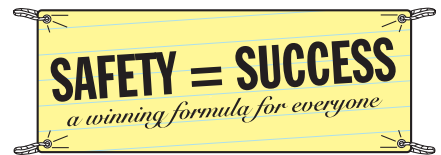

106298 3.5' x 10' vinyl



106332 3' x 5' vinyl



106329 3' x 5' vinyl



106291 3.5' x 10' vinyl



106292 3.5' x 10' vinyl



106293 3.5' x 10' vinyl



106294 3.5' x 10' vinyl



106330 3' x 5' vinyl



50909 3.5' x 10' vinyl



106295 3.5' x 10' vinyl



106296 3.5' x 10' vinyl

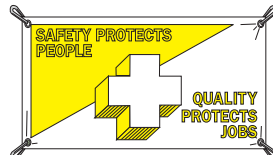

106331 3' x 5' vinyl  
106297 3.5' x 10' vinyl



50907 3.5' x 10' vinyl



106299 3.5' x 10' vinyl



106300 3.5' x 10' vinyl



106303 3.5' x 10' vinyl



# Safety Banners

BradyID.com/s34

## Safety Banners (Continued)

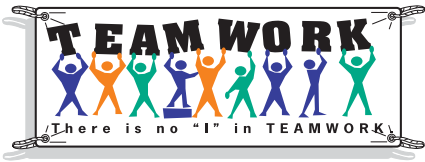

50900 3.5' x 10' vinyl



50911 3.5' x 10' vinyl

**Banner Material**  
Banners are constructed of heavy duty 10 mil vinyl and are recommended for indoor use only.



106304 3.5' x 10' vinyl



106305 3.5' x 10' vinyl



106306 3.5' x 10' vinyl



56968 3' x 5' vinyl



50902 3.5' x 10' vinyl



50912 3.5' x 10' vinyl



50901 3.5' x 10' vinyl



106308 3.5' x 10' vinyl



106307 3.5' x 10' vinyl



106310 3.5' x 10' vinyl



106311 3.5' x 10' vinyl



50903 3.5' x 10' vinyl

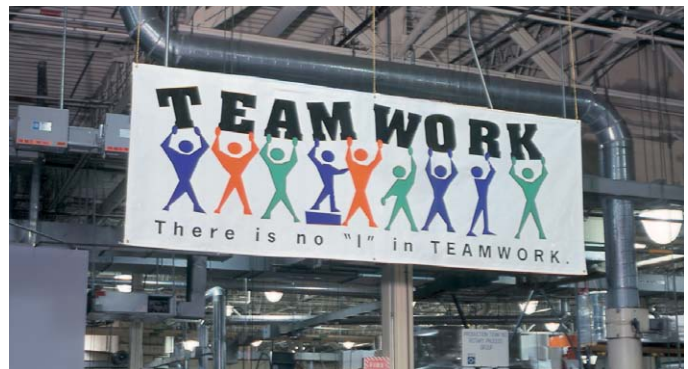

Safety Signs

## Safety Posters

Brady safety banners are concise, easy to understand safety posters that are designed to provide continued reinforcement of your ongoing safety programs.

### Poster Material

Posters are laminated on both sides and are recommended for indoor use only.

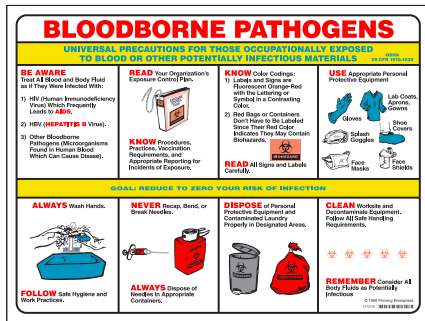

PS125E Bloodborne Pathogens Poster - English 18" x 24" Laminated  
 PS125S Bloodborne Pathogens Poster - Spanish 18" x 24" Laminated

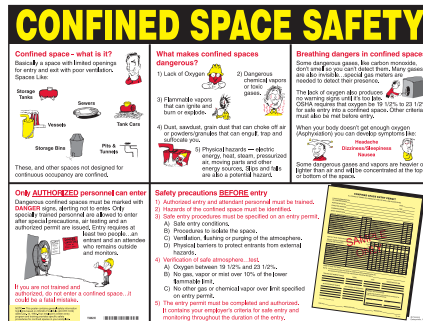

CSP Confined Space Safety Poster - English 18" x 24" Laminated



PS128E Emergency First Aid Poster 18" x 24" Laminated - English



FEFP Fire Extinguisher Safety Poster - English 18" x 24" Laminated



SWG14 Forklift Safety Poster - English 18" x 24" Laminated

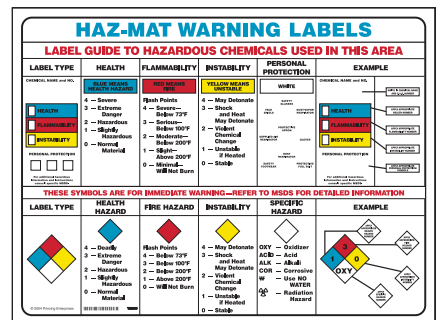

PS135E Haz-Mat Warning Labels Poster - English 18" x 24" Laminated



53202 Hazardous Materials Poster - English 22" x 26" Laminated  
 53203 Hazardous Materials Poster - Spanish 22" x 26" Laminated



BLSP Lift It Safely Poster - English 18" x 24" Laminated

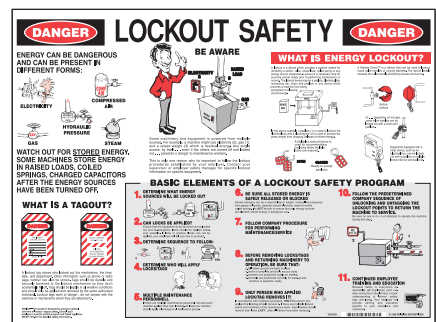

LOSP8 Lockout Safety Poster - English 18" x 24" Laminated  
 LOSP8SP Lockout Safety Poster - Spanish 18" x 24" Laminated



# Safety Posters

BradyID.com/s34

## Safety Posters (Continued)

Safety Signs



MSSP Machine Safety Poster - 18" x 24" Laminated English

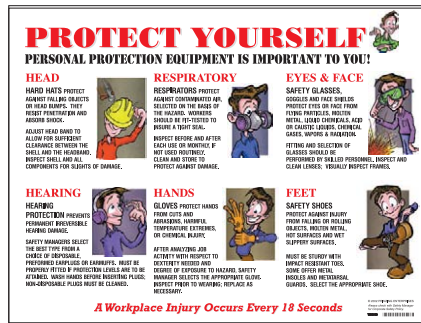

PS127E Protect Yourself PPE Poster - 18" x 24" Laminated English

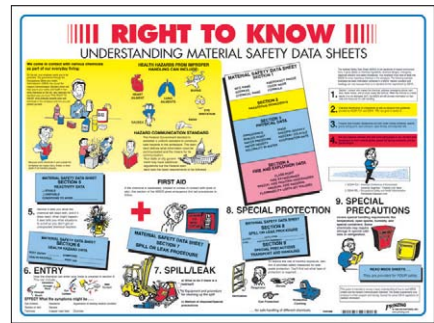

PS139E Right To Know Poster - 18" x 24" Laminated English

PS139S Right To Know Poster - 18" x 24" Laminated Spanish



### OSHA Safety Poster

This laminated poster provides all the postings, notices, and information that the government requires general industry employers to have in their facility. Our unique All-On-One format saves wall space and resolves clutter. It eliminates the need to purchase individual safety posters addressing the most commonly cited OSHA Standards. Poster comes with a laminated First Aid At-A-Glance sheet and a Good Faith Safety Compliance certificate.

Catalog #	Description	Size	Qty.
FD-SS2-L	OSHA Safety Poster	25-1/2" x 39-1/2"	1 set

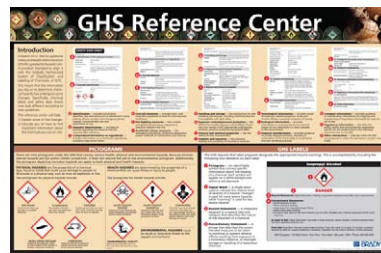

### GHS Reference Center Poster

- This all-inclusive, large format poster gets worker's attention and combines many of the most important changes into one easy-to-read format
- Includes detailed information on:
  - Safety Data Sheet (SDS) format
  - GHS-formatted label elements
  - GHS Hazard Pictograms

Catalog #	Description	Size	Qty.
133209	GHS Reference Center Poster	25.5" x 39.5"	1 each



### GHS Intro Poster Pack

- Set of 3 informational posters puts critical GHS information in different parts of your facility and promotes employee understanding
- Posters outline:
  - An overview of the Globally Harmonized System of Classification and Labeling of Chemicals
  - Information regarding the new Safety Data Sheets format and outline
  - Information regarding the new GHS-formatted label elements

Catalog #	Description	Size	Qty.
133207	GHS Intro Posters	17" x 22"	1 set of 3



May we also suggest:

### Sign Holder For Posters

Clear plexi-glass poster holder allows you to store different posters and to rotate the display according to your safety program.

Catalog #	Description	Size	Color	Qty.
SH1824	Sign Holder For Posters	18" x 24"	Clear	1

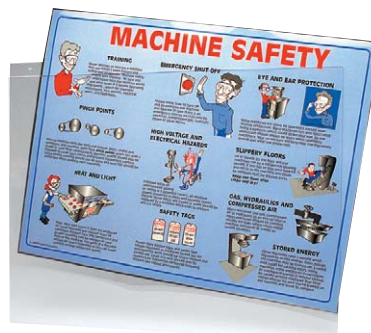

## Safety Slogan Signs

Brady safety awareness signs will promote safety and teamwork in your facility while helping you comply with OSHA regulations for accident prevention. Brady safety awareness signs are highly noticeable and available in a wide array of sizes and materials and available for almost any application.

### Popular Sign Materials

- FB** - Premium Fiberglass (B-120)
  - SS** - Self-Sticking Polyester (B-302)
  - BGSS** - BradyGlo™ Self-Sticking Polyester (B-324)
  - BGPL** - BradyGlo™ Plastic (B-347)
  - PL** - Plastic (B-401)
  - AL** - Aluminum (B-555)
- View all sign materials on page 25.*

### Can't find your sign?

Use the Sign Legend Index on page 498 or take advantage of our custom sign options.

**!** **OSHA Regulations**

**Safety Instruction Signs 1910.145(c)(3)**  
Safety instruction signs shall be used where there is a need for general instructions and suggestions relative to safety measures.

**BE CAREFUL**  
A CAREFUL WORKMAN IS THE BEST SAFETY DEVICE

72605	14" x 20"	FB
88791	10" x 14"	SS
25295	7" x 10"	PL

**BE CAREFUL**  
OTHERS ARE DEPENDING ON YOU DON'T TAKE CHANCES

25297	7" x 10"	PL
25298	10" x 14"	PL
88806	7" x 10"	SS
42874	7" x 10"	AL

**BE CAREFUL**  
STAY ALERT DON'T GET HURT

88810	7" x 10"	SS
88811	10" x 14"	SS
25299	7" x 10"	PL
25300	10" x 14"	PL
42876	7" x 10"	AL

**BE CAREFUL**  
THE SAFE WAY IS THE BEST WAY

72936	14" x 20"	FB
88814	7" x 10"	SS
88815	10" x 14"	SS
25301	7" x 10"	PL
25302	10" x 14"	PL
42879	10" x 14"	AL

**SAFETY FIRST**  
A CAREFUL WORKMAN IS THE BEST SAFETY DEVICE

88830	7" x 10"	SS
88831	10" x 14"	SS
25307	7" x 10"	PL

**SAFETY FIRST**  
A FIRE TODAY NO JOB TOMORROW

25688	7" x 10"	PL
25689	10" x 14"	PL
43265	7" x 10"	AL

**SAFETY FIRST**  
BE CAREFUL

69755	10" x 14"	FB
88834	7" x 10"	SS
88835	10" x 14"	SS
25309	7" x 10"	PL
25310	10" x 14"	PL
42887	10" x 14"	AL

**SAFETY FIRST**  
DON'T TRY TO LIFT MORE THAN YOU ARE ABLE

69173	10" x 14"	FB
88838	7" x 10"	SS
88839	10" x 14"	SS
25311	7" x 10"	PL
25312	10" x 14"	PL
42888	7" x 10"	AL
42889	10" x 14"	AL

**SAFETY FIRST**  
FOR YOUR OWN SAFETY TALK SAFETY

88840	7" x 10"	SS
25313	7" x 10"	PL
25314	10" x 14"	PL
42891	10" x 14"	AL

**SAFETY FIRST**  
IS OUR RESPONSIBILITY EACH AND EVERY ONE OF US

88842	7" x 10"	SS
88843	10" x 14"	SS
25315	7" x 10"	PL
25316	10" x 14"	PL
42893	10" x 14"	AL

**SAFETY FIRST**  
LET US ALL BE SAFETY INSPECTORS, REPORT UNSAFE PLACES TO YOUR FOREMAN OR THE SAFETY DEPARTMENT

69333	10" x 14"	FB
88846	7" x 10"	SS
25317	7" x 10"	PL
42895	10" x 14"	AL

**SAFETY FIRST**  
MAKE YOUR WORK PLACE SAFE BEFORE STARTING THE JOB

69352	10" x 14"	FB
88848	7" x 10"	SS
88849	10" x 14"	SS
25319	7" x 10"	PL
25320	10" x 14"	PL
42896	7" x 10"	AL
42897	10" x 14"	AL

**SAFETY FIRST**  
REPORT ALL ACCIDENTS

87682	7" x 10"	FB
35478	10" x 14"	SS
35480	10" x 14"	PL

**SAFETY FIRST**  
REPORT ALL ACCIDENTS NO MATTER HOW SMALL TO YOUR FOREMAN

73471	7" x 10"	FB
-------	----------	----

**SAFETY FIRST**  
REPORT ALL UNSAFE CONDITIONS TO YOUR FOREMAN

69464	10" x 14"	FB
88852	7" x 10"	SS
88853	10" x 14"	SS
25323	7" x 10"	PL
25324	10" x 14"	PL
42900	7" x 10"	AL
42901	10" x 14"	AL

**THINK**  
ACCIDENTS ARE AVOIDABLE FORGET THE ALIBI

88860	7" x 10"	SS
88861	10" x 14"	SS
42902	7" x 10"	AL
42903	10" x 14"	AL
70205	10" x 14"	FB
25325	7" x 10"	PL
25326	10" x 14"	PL

**THINK**  
BEFORE YOU ACT

73449	10" x 14"	FB
88864	7" x 10"	SS
88865	10" x 14"	SS
25327	7" x 10"	PL
25328	10" x 14"	PL
42904	7" x 10"	AL
42905	10" x 14"	AL

**THINK**  
DON'T TAKE CHANCES OTHERS ARE DEPENDING ON YOU

70293	10" x 14"	FB
88866	7" x 10"	SS
25329	7" x 10"	PL
25330	10" x 14"	PL
42906	7" x 10"	AL
42907	10" x 14"	AL

**THINK**  
MAKE EVERY MOVE A SAFE ONE

73464	10" x 14"	FB
88870	7" x 10"	SS
88871	10" x 14"	SS
25331	7" x 10"	PL
25332	10" x 14"	PL
42909	10" x 14"	AL

**THINK**  
ON THE JOB SAFETY BEGINS HERE

70462	10" x 14"	FB
88872	7" x 10"	SS
88873	10" x 14"	SS
25333	7" x 10"	PL
25334	10" x 14"	PL
42910	7" x 10"	AL
42911	10" x 14"	AL

**THINK**  
OUR AIM NO ACCIDENTS

69414	10" x 14"	FB
88874	7" x 10"	SS
88875	10" x 14"	SS
25335	7" x 10"	PL
25336	10" x 14"	PL
42912	7" x 10"	AL
42913	10" x 14"	AL

**THINK**  
SAFETY... WORK SAFELY

25337	7" x 10"	PL
25338	10" x 14"	PL
42914	7" x 10"	AL
42915	10" x 14"	AL
88876	7" x 10"	SS
88877	10" x 14"	SS



# Safety Slogan Signs / Scoreboards

BradyID.com/s34

## Safety Slogan Signs (Continued)



69515	10" x 14"	FB
88878	7" x 10"	SS
88879	10" x 14"	SS
25339	7" x 10"	PL
25340	10" x 14"	PL
42916	7" x 10"	AL
42917	10" x 14"	AL



88880	7" x 10"	SS
25341	7" x 10"	PL
25342	10" x 14"	PL
42918	7" x 10"	AL
88881	10" x 14"	SSV



70578	10" x 14"	FB
25343	7" x 10"	PL
25344	10" x 14"	PL
42920	7" x 10"	AL
42921	10" x 14"	AL



25346	10" x 14"	PL
42923	10" x 14"	AL

**Popular Sign Materials**

**FB** - Premium Fiberglass (B-120)  
**SS** - Self-Sticking Polyester (B-302)  
**SSV** - Self-Sticking Vinyl (B-946)  
**BGSS** - BradyGlo™ Self-Sticking Polyester (B-324)  
**BGPL** - BradyGlo™ Plastic (B-347)  
**PL** - Plastic (B-401)  
**AL** - Aluminum (B-555)

*View all sign materials on page 25.*

**Can't find your sign?**  
*Use the Sign Legend Index on page 498 or take advantage of our custom sign options.*



69785	14" x 20"	FB
88898	7" x 10"	SS
88899	10" x 14"	SS
25347	7" x 10"	PL
42924	7" x 10"	AL



70518	10" x 14"	FB
88905	7" x 10"	SS
25348	7" x 10"	PL
25349	10" x 14"	PL
42925	7" x 10"	AL
42926	10" x 14"	AL



73423	20" x 28"	FB
-------	-----------	----



90786	5" x 14"	BGPL
-------	----------	------



76093	10" x 14"	FB
88908	7" x 10"	SS
88909	10" x 14"	SS
25350	7" x 10"	PL
25351	10" x 14"	PL
42928	10" x 14"	AL



88910	7" x 10"	SS
88911	10" x 14"	SS
42929	7" x 10"	AL

## Scoreboards Signs

Brady safety scoreboards help you track your facility's safety performance, and motivate your employees to maintain safe work practices. Brady safety scoreboards are made of durable 18 gauge steel.



49113 28" x 20" 20 Gauge Steel



49117 28" x 20" 20 Gauge Steel



49111 28" x 20" 20 Gauge Steel



49115 28" x 20" 20 Gauge Steel



49112 28" x 20" 20 Gauge Steel



49116 28" x 20" 20 Gauge Steel



49114 28" x 20" 20 Gauge Steel



### Magnetic Numbers for Scoreboard Signs

- Number height is 1-1/2"
- 15 each of 0-3; 8 each of 4-9

Catalog #	Size	Qty.
57624	1-1/2"	108

## Security Signs

Brady security signs deter unwanted visitors and keep your facility safe with a variety of messages, including: video surveillance, restricted areas, and "no trespassing" notices.

<p><b>NOTICE</b></p> <p>ALL EMPLOYEES AND VISITORS MUST WEAR IDENTIFICATION BADGES</p>	<p><b>NOTICE</b></p> <p>ALL VEHICLES ENTERING OR LEAVING SUBJECT TO SEARCH</p>	<p><b>-NOTICE-</b></p> <p>FOR SECURITY REASONS INDIVIDUALS ENTERING OR LEAVING THE PREMISES MAY BE SUBJECT TO SEARCH OF THEIR VEHICLES, PARCELS, OR OTHER UNUSUAL ITEMS</p>	<p><b>NOTICE</b></p> <p>NO ALCOHOLIC BEVERAGES OR DRUGS PERMITTED ON COMPANY PROPERTY THIS INCLUDES THE PARKING LOT</p>	<p><b>NOTICE</b></p> <p>NO PHONES, CAMERAS OR OTHER ELECTRONIC DEVICES PERMITTED</p>	<p><b>NOTICE</b></p> <p>THIS AREA IS UNDER 24 HOUR TV SURVEILLANCE TRESPASSERS WILL BE PROSECUTED</p>
129407 7" x 10" SS 129410 10" x 14" SS 129406 7" x 10" PL 129409 10" x 14" PL 129405 7" x 10" AL 129408 10" x 14" AL	95418 10" x 14" PL	95462 14" x 20" FB	123595 7" x 10" SS 123598 10" x 14" SS 123594 7" x 10" PL 123597 10" x 14" PL 123593 7" x 10" AL 123596 10" x 14" AL	132047 7" x 10" FB 132048 10" x 14" FB 132045 7" x 10" SS 132046 10" x 14" SS 132043 7" x 10" PL 132044 10" x 14" PL 132041 7" x 10" AL 132042 10" x 14" AL	123601 10" x 7" SS 123604 14" x 10" SS 123600 10" x 7" PL 123603 14" x 10" PL 123599 10" x 7" AL 123602 14" x 10" AL
<p><b>NOTICE</b></p> <p>VENDORS AND VISITORS MUST REGISTER AT MAIN OFFICE</p>	<p><b>RESTRICTED AREA</b></p> <p>ALL VISITORS MUST GET PASS AT OFFICE</p>	<p><b>RESTRICTED AREA</b></p> <p>AUTHORIZED PERSONNEL ONLY</p>	<p><b>RESTRICTED AREA</b></p> <p>DO NOT ENTER</p>	<p><b>RESTRICTED AREA</b></p> <p>DO NOT ENTER AUTHORIZED PERSONNEL ONLY</p>	<p><b>RESTRICTED AREA</b></p> <p>ENTRANCE FOR EMPLOYEES ONLY</p>
123589 7" x 10" SS 123592 10" x 14" SS 123588 7" x 10" PL 123591 10" x 14" PL 123587 7" x 10" AL 123590 10" x 14" AL	122865 7" x 10" FB 122727 10" x 14" FB 122658 7" x 10" SS 122581 10" x 14" SS 122531 7" x 10" PL 95465 10" x 14" PL 122422 7" x 10" AL 122356 10" x 14" AL	95466 10" x 14" PL	95467 10" x 14" PL	122869 7" x 10" FB 122730 10" x 14" FB 122661 7" x 10" SS 122584 10" x 14" SS 122534 7" x 10" PL 95468 10" x 14" PL 122425 7" x 10" AL 122359 10" x 14" AL	95469 10" x 14" PL
<p><b>RESTRICTED AREA</b></p> <p>NO ADMITTANCE EMPLOYEES ONLY</p>	<p><b>RESTRICTED AREA</b></p> <p>NO ADMITTANCE WITHOUT AUTHORIZATION</p>	<p><b>RESTRICTED AREA</b></p> <p>NO ENTRY UNLESS AUTHORIZED</p>	<p><b>RESTRICTED AREA</b></p> <p>NO TRESPASSING</p>	<p><b>RESTRICTED AREA</b></p> <p>NO TRESPASSING UNDER PENALTY OF THE LAW</p>	<p><b>RESTRICTED AREA</b></p> <p>NOT AN ENTRANCE</p>
122875 7" x 10" FB 122736 10" x 14" FB 122671 7" x 10" SS 122594 10" x 14" SS 122540 7" x 10" PL 95470 10" x 14" PL 122431 7" x 10" AL 122363 10" x 14" AL	95471 10" x 14" PL	95472 10" x 14" PL	95473 10" x 14" PL	95474 10" x 14" PL	95475 10" x 14" PL
<p><b>RESTRICTED AREA</b></p> <p>ONLY AUTHORIZED PERSONS TO ENTER THIS AREA</p>	<p><b>RESTRICTED AREA</b></p> <p>PRIVATE NO TRESPASSING</p>	<p><b>RESTRICTED AREA</b></p> <p>SECURITY ALARM WILL SOUND IF DOOR IS OPENED</p>	<p><b>RESTRICTED AREA</b></p> <p>THIS PROPERTY PROTECTED BY ELECTRONIC SURVEILLANCE</p>	<p><b>RESTRICTED AREA</b></p> <p>MONITORED BY VIDEO CAMERA</p>	<p><b>SECURITY NOTICE</b></p> <p>ALL VISITORS MUST REPORT TO SECURITY</p>
95476 10" x 14" PL	95477 10" x 14" PL	95478 10" x 14" PL	95479 10" x 14" PL	123528 7" x 10" SS 123531 10" x 14" SS 123527 7" x 10" PL 123530 10" x 14" PL 123526 7" x 10" AL 123529 10" x 14" AL	122866 7" x 10" FB 122728 10" x 14" FB 122659 7" x 10" SS 122582 10" x 14" SS 122532 7" x 10" PL 122480 10" x 14" PL 95481 14" x 20" PL 122423 7" x 10" AL 122357 10" x 14" AL
<p><b>SECURITY NOTICE</b></p> <p>NO ADMITTANCE BEYOND THIS POINT CHECK WITH GUARD</p>	<p><b>SECURITY NOTICE</b></p> <p>NO ADMITTANCE BEYOND THIS POINT CHECK WITH SECURITY</p>	<p><b>SECURITY NOTICE</b></p> <p>NO ADMITTANCE WITHOUT SECURITY PASS</p>	<p><b>SECURITY NOTICE</b></p> <p>PARKING PERMITS ARE REQUIRED IN THIS AREA UNAUTHORIZED VEHICLES WILL BE TOWED</p>	<p><b>SECURITY NOTICE</b></p> <p>PRIVATE PROPERTY KEEP OUT</p>	<p><b>SECURITY NOTICE</b></p> <p>PRIVATE PROPERTY TRESPASSERS WILL BE PROSECUTED</p>
95483 14" x 20" PL	95484 14" x 20" PL	95485 14" x 20" PL	95486 14" x 20" PL	95487 14" x 20" PL	95488 14" x 20" PL



# Security Signs

BradyID.com/s34

## Security Signs (Continued)

Safety Signs



95489 14" x 20" PL



122886 7" x 10" FB  
122746 10" x 14" FB  
122682 7" x 10" SS  
122604 10" x 14" SS  
122550 7" x 10" PL  
122486 10" x 14" PL  
95491 14" x 20" PL  
122441 7" x 10" AL  
122372 10" x 14" AL



95492 14" x 20" PL



95493 14" x 20" PL

**Popular Sign Materials**

- FB - Premium Fiberglass (B-120)
- SS - Self-Sticking Polyester (B-302)
- SSV - Self-Sticking Vinyl (B-946)
- BGSS - BradyGlo™ Self-Sticking Polyester (B-324)
- BGPL - BradyGlo™ Plastic (B-347)
- PL - Plastic (B-401)
- AL - Aluminum (B-555)

*View all sign materials on page 25.*

**Can't find your sign?**  
*Use the Sign Legend Index on page 498 or take advantage of our custom sign options.*



122888 7" x 10" FB  
122748 10" x 14" FB  
122684 7" x 10" SS  
122606 10" x 14" SS  
122552 7" x 10" PL  
122487 10" x 14" PL  
95494 14" x 20" PL  
122443 7" x 10" AL  
122374 10" x 14" AL



95495 14" x 20" PL



122889 7" x 10" FB  
122749 10" x 14" FB  
122685 7" x 10" SS  
122607 10" x 14" SS  
122553 7" x 10" PL  
122488 10" x 14" PL  
95496 14" x 20" PL  
122444 7" x 10" AL  
122375 10" x 14" AL



95426 10" x 14" PL



95427 10" x 14" PL



95428 10" x 14" PL

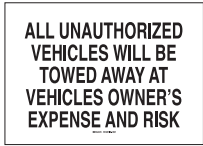

95461 14" x 20" FB



95459 14" x 20" FB



132025 7" x 10" FB  
132026 10" x 14" FB  
132023 7" x 10" SS  
132024 10" x 14" SS  
132022 7" x 10" PL  
132020 7" x 10" AL  
132021 10" x 14" AL



122867 7" x 10" FB  
122729 10" x 14" FB  
122660 7" x 10" SS  
122583 10" x 14" SS  
122533 7" x 10" PL  
95411 10" x 14" PL  
122424 7" x 10" AL  
122358 10" x 14" AL

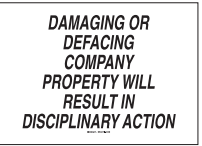

95412 10" x 14" PL



40782 10" x 14" AL



95431 10" x 14" PL



95432 10" x 14" PL



95458 14" x 20" FB



95433 10" x 14" PL



95434 10" x 14" PL



95435 10" x 14" PL



With "same-as-stock" custom pricing, you can create a custom security sign to fit your facility needs with no additional cost.



95436 10" x 14" PL



122876 7" x 10" FB  
122737 10" x 14" FB  
95463 14" x 20" FB  
122672 7" x 10" SS  
122595 10" x 14" SS  
122541 7" x 10" PL  
95413 10" x 14" PL  
122432 7" x 10" AL  
122364 10" x 14" AL



122879 7" x 10" FB  
122740 10" x 14" FB  
122675 7" x 10" SS  
122598 10" x 14" SS  
122544 7" x 10" PL  
95414 10" x 14" PL  
122435 7" x 10" AL  
122367 10" x 14" AL



## Security Signs (Continued)



122880	7" x 10"	FB
122741	10" x 14"	FB
122676	7" x 10"	SS
122599	10" x 14"	SS
122545	7" x 10"	PL
95415	10" x 14"	PL
122436	7" x 10"	AL
122368	10" x 14"	AL



95416	10" x 14"	PL
-------	-----------	----



90498	14" x 20"	FB
-------	-----------	----



95417	10" x 14"	PL
-------	-----------	----



123485	10" x 7"	SS
123488	14" x 10"	SS
123484	10" x 7"	PL
123487	14" x 10"	PL
123483	10" x 7"	AL
123486	14" x 10"	AL



129413	7" x 10"	SS
129416	10" x 14"	SS
129412	7" x 10"	PL
129415	10" x 14"	PL
129411	7" x 10"	AL
129414	10" x 14"	AL



95457	14" x 20"	FB
-------	-----------	----



90499	14" x 20"	FB
-------	-----------	----



95456	14" x 20"	FB
-------	-----------	----



123522	10" x 7"	SS
123525	14" x 10"	SS
123521	10" x 7"	PL
123524	14" x 10"	PL
123520	10" x 7"	AL
123523	14" x 10"	AL



122881	7" x 10"	FB
122742	10" x 14"	FB
95452	24" x 18"	FB
122677	7" x 10"	SS
122600	10" x 14"	SS
122546	7" x 10"	PL
95429	20" x 14"	PL
122437	7" x 10"	AL
122369	10" x 14"	AL

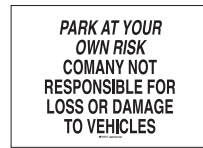

95420	10" x 14"	PL
-------	-----------	----



95453	24" x 18"	FB
95430	20" x 14"	PL



122885	7" x 10"	FB
122745	10" x 14"	FB
122681	7" x 10"	SS
122603	10" x 14"	SS
122549	7" x 10"	PL
95421	10" x 14"	PL
122440	7" x 10"	AL
122371	10" x 14"	AL



95438	10" x 14"	PL
-------	-----------	----



95437	10" x 14"	PL
-------	-----------	----



129419	7" x 10"	SS
129422	10" x 14"	SS
129418	7" x 10"	PL
129421	10" x 14"	PL
129417	7" x 10"	AL
129420	10" x 14"	AL



123482	24" x 36"	SS
123481	24" x 36"	PL
123480	24" x 36"	AL



95027	11" x 11"	PL
-------	-----------	----



122887	7" x 10"	FB
122747	10" x 14"	FB
122683	7" x 10"	SS
122605	10" x 14"	SS
122551	7" x 10"	PL
95424	10" x 14"	PL
122442	7" x 10"	AL
122373	10" x 14"	AL



90540	14" x 20"	FB
-------	-----------	----

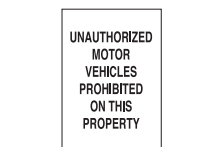

95450	24" x 18"	FB
-------	-----------	----



123534	10" x 7"	SS
123537	14" x 10"	SS
123533	10" x 7"	PL
123536	14" x 10"	PL
123532	10" x 7"	AL
123535	14" x 10"	AL



95451	24" x 18"	FB
-------	-----------	----



95423	10" x 14"	PL
-------	-----------	----



95455	14" x 20"	FB
-------	-----------	----

### May we also suggest:

### Homeland Security Signs

Security signs with easily changeable panels to indicate the threat level so everyone is prepared and alerted.



103644 30" x 24" Steel



132451 24" x 24" Aluminum



132449 24" x 24" Aluminum

# Temporary Signs

BradyID.com/s34

## Temporary Signs

Brady temporary signs communicate short term messages in specific areas. Temporary signs are ideal for temporary parking control, temporary traffic control, work area safety notifications or short-term construction projects. Brady's temporary signs are especially helpful for solving seasonal parking issues or during parking lot repaving. Available in a variety of sizes, Brady temporary signs are constructed of corrugated polypropylene

### Material Information

B-836 (TMP) is a lightweight corrugated plastic sign material for indoor use or secured outdoor use.

View the full sign materials index on page 25.

### Can't find your sign?

Use the Sign Legend Index on page 498 or take advantage of our custom sign options.

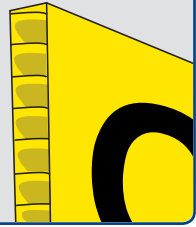

78037 18" x 24" TMP



78035 18" x 24" TMP



78036 18" x 24" TMP



78031 18" x 24" TMP



78033 18" x 24" TMP



78055 18" x 24" TMP



78002 18" x 24" TMP



78014 18" x 24" TMP



78003 18" x 24" TMP



78011 18" x 24" TMP



78004 18" x 24" TMP



78013 18" x 24" TMP



78009 18" x 24" TMP



78015 18" x 24" TMP



78007 18" x 24" TMP



78016 18" x 24" TMP



78010 18" x 24" TMP



78018 18" x 24" TMP



78019 18" x 24" TMP



78000 18" x 24" TMP

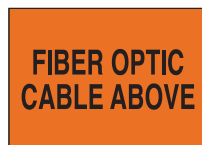

45431 5' x 7' TMP



78047 18" x 12" TMP



78049 18" x 12" TMP

## Construction Traffic Signs

Brady construction signs warn employees, pedestrians and visitors of the potential dangers of road or parking lot construction areas. These roll-up bright orange construction signs indicate temporary road closings, detours, shoulder work and more. These signs include flexible fiberglass frames, which fit into plastic or sewn corner pockets, to achieve maximum performance, even in the windiest conditions. Signs are available in a variety of sizes, and are also available in mesh or reflective vinyl.



Non-Reflective Mesh  
57023 36" x 36"  
Reflective Vinyl  
57026 48" x 48"



Reflective Vinyl  
56795 36" x 36"



Non-Reflective Mesh  
56699 36" x 36"  
56727 48" x 48"  
Reflective Vinyl  
56726 36" x 36"



Reflective Vinyl  
56750 36" x 36"



Non-Reflective Mesh  
56767 48" x 48"



Reflective Vinyl  
56789 48" x 48"



Reflective Vinyl  
56791 36" x 36"



Non-Reflective Mesh  
56798 36" x 36"  
56800 48" x 48"  
Reflective Vinyl  
56799 36" x 36"



Reflective Vinyl  
56818 48" x 48"



Reflective Vinyl  
56897 36" x 36"



Non-Reflective Mesh  
57001 48" x 48"



Non-Reflective Mesh  
57005 48" x 48"  
Reflective Vinyl  
57004 36" x 36"  
57006 48" x 48"



Reflective Vinyl  
57014 48" x 48"



Non-Reflective Mesh  
57017 48" x 48"  
Reflective Vinyl  
57016 36" x 36"  
57018 48" x 48"



Non-Reflective Mesh  
57021 48" x 48"  
Reflective Vinyl  
57020 36" x 36"  
57022 48" x 48"



Non-Reflective Mesh  
57029 48" x 48"  
Reflective Vinyl  
57030 48" x 48"



Non-Reflective Mesh  
57031 36" x 36"  
57033 48" x 48"  
Reflective Vinyl  
57032 36" x 36"  
57034 48" x 48"



Non-Reflective Mesh  
57037 48" x 48"  
57036 36" x 36"  
Reflective Vinyl  
57038 48" x 48"  
57034 48" x 48"



Reflective Vinyl  
57050 48" x 48"



Non-Reflective Mesh  
57045 48" x 48"

### Construction Sign Accessories

Catalog #	Description	Qty.
57067	Sign Stand	1
57069	Tripod	1
57072	Warning Flag Assembly	1
13377	Warning Flag	1
57070	36" Cross Ribs	1 set
57071	48" Cross Ribs	1 set



**Construction barricades available on page 193.**



# Handicapped Parking Signs

BradyID.com/s34

## Handicapped Parking Signs

Brady handicap signs are designed with bright colors and pictograms to clearly identify accommodations for those with disabilities or special needs. These handicap signs meet state and federal MUTCD guidelines.

### Popular Sign Materials

- FB** - Premium Fiberglass (B-120)
  - SS** - Self-Sticking Polyester (B-302)
  - BGSS** - BradyGlo™ Self-Sticking Polyester (B-324)
  - BGPL** - BradyGlo™ Plastic (B-347)
  - PL** - Plastic (B-401)
  - AL** - Aluminum (B-555)
  - RFAL** - Reflective Aluminum (B-959)
- View all sign materials on page 25.*

### Can't find your sign?

*Use the Sign Legend Index on page 498 or take advantage of our custom sign options.*

### ADA Handicapped Parking Guideline

Parking Spaces Per Lot	Min Number of Reserved Spaces
1 to 25	1
26 to 50	2
51 to 75	3
76 to 100	4
101 to 150	5
151 to 200	6
201 to 300	7
301 to 400	8
401 to 500	9
501 to 1,000	2% of total
More than 1,000	20 plus 1 for every 100 over 1,000

Traffic Signs



94336	6' x 6'	FB
91324	9' x 9'	FB
94112	12' x 12'	FB
91370	14' x 10'	SS
94174	12' x 12'	RFAL



91372	14' x 10'	SS
91352	18' x 12'	RFAL



91371	14' x 10'	SS
91351	18' x 12'	RFAL



69277	9' x 9'	FB
88509	9' x 9'	SS
25173	10' x 14'	PL



91326	6' x 12'	RFAL
-------	----------	------



91010	6' x 12'	RFAL
-------	----------	------



80049	6' x 12'	RFAL
-------	----------	------



112500	6' x 12'	RFAL
--------	----------	------



91354	18' x 12'	RFAL
-------	-----------	------



91378	12' x 18"	FB
91376	10' x 14"	SS
91377	12' x 18"	RFAL



90018	18' x 12'	RFAL
-------	-----------	------



123876	18' x 18"	PL
123878	24' x 24"	PL
123875	18' x 18"	AL
123877	24' x 24"	AL



91331	12' x 18"	FB
91357	12' x 18"	RFAL



91332	9' x 9'	FB
91333	12' x 12"	FB
76871	18' x 18"	FB
91358	12' x 12"	RFAL
91359	18' x 18"	RFAL



80110	18' x 12"	RFAL
-------	-----------	------



91334	18' x 12"	FB
91360	18' x 12"	RFAL



123874	18' x 12"	SS
123873	18' x 12"	PL
123872	18' x 12"	AL



91356	18' x 12"	RFAL
-------	-----------	------



91336	18' x 12"	FB
91362	18' x 12"	RFAL

# Handicapped Parking Signs

BradyID.com/s34

## Handicapped Parking Signs (Continued)



145438	18" x 12"	FB
145439	18" x 12"	RFAL



145441	18" x 12"	FB
145442	18" x 12"	RFAL



127469	18" x 12"	SS
127468	18" x 12"	PL
127467	18" x 12"	AL



123887	18" x 12"	SS
123886	18" x 12"	PL
123885	18" x 12"	AL



145440	18" x 12"	RFAL
--------	-----------	------



127475	18" x 12"	SS
127474	18" x 12"	PL
127473	18" x 12"	AL



127454	18" x 12"	SS
127453	18" x 12"	PL
127452	18" x 12"	AL



94175	18" x 12"	RFAL
-------	-----------	------



145443	18" x 12"	RFAL
--------	-----------	------



123890	18" x 12"	SS
123889	18" x 12"	PL
123888	18" x 12"	AL



127457	18" x 12"	SS
127456	18" x 12"	PL
127455	18" x 12"	AL



127460	18" x 12"	SS
127459	18" x 12"	PL
127458	18" x 12"	AL



127472	18" x 12"	SS
127471	18" x 12"	PL
127470	18" x 12"	AL



127466	18" x 12"	SS
127465	18" x 12"	PL
127464	18" x 12"	AL



91386	24" x 18"	FB
91388	18" x 12"	RFAL
91389	24" x 18"	RFAL



127481	10" x 14"	SS
127480	10" x 14"	PL
127479	10" x 14"	AL



91387	6" x 12"	RFAL
91384	6" x 12"	RFAL



123871	18" x 12"	SS
123870	18" x 12"	PL
123869	18" x 12"	AL



127463	18" x 12"	SS
127462	18" x 12"	PL
127461	18" x 12"	AL



91375	14" x 10"	SS
91363	18" x 12"	RFAL



# E-Vehicle Parking Signs

BradyID.com/s34

## E-Vehicle Parking Signs

A number of agencies are installing electric vehicle charging facilities at on-street parking locations as electric vehicles become more prevalent in the vehicle fleet. These signs communicate electric vehicle parking and charging locations and comply with MUTCD guidelines.

### Popular Sign Materials

**AL-** Aluminum (B-555)  
**RFAL-** Reflective Aluminum (B-959)  
 View all sign materials on page 25.

### Can't find your sign?

Use the Sign Legend Index on page 498 or take advantage of our custom sign options.



141672 18" x 12" RFAL



141673 18" x 12" RFAL



141671 18" x 12" RFAL



141678 18" x 12" RFAL



141679 18" x 12" RFAL



141677 18" x 12" RFAL



141675 18" x 12" RFAL



141676 18" x 12" RFAL



141674 18" x 12" RFAL



141683 18" x 12" RFAL



141684 18" x 12" RFAL



141682 18" x 12" RFAL



141686 18" x 12" RFAL



141687 18" x 12" RFAL



141685 18" x 12" RFAL



141689 18" x 12" RFAL



141690 18" x 12" RFAL

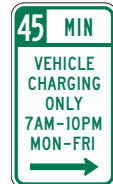

141688 18" x 12" RFAL



141698 18" x 12" AL



141695 18" x 12" AL



141696 24" x 24" AL



141661 18" x 12" AL



141665 18" x 12" RFAL

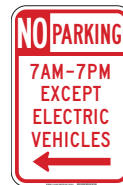

141666 18" x 12" RFAL



141664 18" x 12" RFAL



141662 18" x 12" RFAL



141663 18" x 12" RFAL



141660 18" x 12" RFAL



141668 18" x 12" RFAL



141669 18" x 12" RFAL



141667 18" x 12" RFAL



141697 18" x 12" AL



141681 6" x 12" B-959



141680 6" x 12" RFAL

## Rail Signs











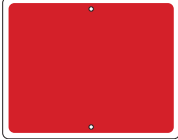





Railroad specific signs are highly durable and visible in day or night conditions. Made in both blue and red, these new signs help you comply with the Federal Railroad Administration and OSHA regulations. In the railroad industry, blue is the traditional color for "STOP", and has been used in the rail industry to indicate protection of parked rail cars and the crews working on them. Red is also acceptable for OSHA compliance, as some states and local railroad regulations require red signs on industrial sidings (a low-speed track section).

### Rail Sign Material

Rail Signs are made of .080" thick engineer grade reflective aluminum (B-959) unless otherwise noted. View all sign materials on page 25.

### Can't find your sign?

Use the Sign Legend Index on page 498 or take advantage of our custom sign options.

					
134193 12" x 15" RFAL	134194 12" x 15" RFAL	134177 12" x 15" RFAL	134178 12" x 15" RFAL	134189 12" x 15" RFAL	134190 12" x 15" RFAL
					
70537 10" x 14" FB	70536 10" x 14" FB	134184 12" x 15" RFAL	134183 12" x 15" RFAL	134187 12" x 15" RFAL	134188 12" x 15" RFAL
					
134186 12" x 15" RFAL	134185 12" x 15" RFAL	122897 7" x 10" FB 75211 10" x 14" FB 122691 7" x 10" SS 122614 10" x 14" SS 122493 10" x 14" PL 122447 7" x 10" AL 122379 10" x 14" AL	75212 12" x 15" FB	134191 12" x 15" RFAL	134192 12" x 15" RFAL

## Custom Signs

Brady's "Same as Stock" custom sign pricing makes it easy to create signs unique to your facility.

View page 194 for more information.



# Traffic Control Signs

BradyID.com/s34

## Traffic Control Signs

Brady traffic signs provide clear, concise direction to traffic inside and outside your building. Brady traffic signs are designed to meet MUTCD specifications, so they can be used in almost any application. These traffic signs guide vehicle traffic, inform employees about areas under repair and improve safety and productivity throughout your property. Available in a variety of sizes and materials, Brady traffic signs can be used in crosswalks, parking lots and more.

### Popular Sign Materials

- FB** - Premium Fiberglass (B-120)
  - SS** - Self-Sticking Polyester (B-302)
  - BGSS** - BradyGlo™ Self-Sticking Polyester (B-324)
  - BGPL** - BradyGlo™ Plastic (B-347)
  - PL** - Plastic (B-401)
  - AL** - Aluminum (B-555)
  - RFAL** - Reflective Aluminum (B-959)
- View all sign materials on page 25.*

### Can't find your sign?

*Use the Sign Legend Index on page 498 or take advantage of our custom sign options.*

Traffic Signs



69100	10" x 14"	FB
22052	10" x 14"	PL
40616	10" x 14"	AL



70223	10" x 14"	FB
25792	10" x 14"	PL
43369	10" x 14"	AL



75082	10" x 14"	FB
25795	10" x 14"	PL
43372	10" x 14"	AL



75118	10" x 14"	FB
25798	10" x 14"	PL
43375	10" x 14"	AL



129503	7" x 10"	SS
129506	10" x 14"	SS
129502	7" x 10"	PL
129505	10" x 14"	PL
129501	7" x 10"	AL
129504	10" x 14"	AL



124207	10" x 7"	SS
124210	14" x 10"	SS
124206	10" x 7"	PL
124209	14" x 10"	PL
124205	10" x 7"	AL
124208	14" x 10"	AL



25801	10" x 14"	PL
43378	10" x 14"	AL



124189	10" x 7"	SS
124192	14" x 10"	SS
124188	10" x 7"	PL
124191	14" x 10"	PL
124187	10" x 7"	AL
124190	14" x 10"	AL



129509	7" x 10"	SS
129512	10" x 14"	SS
129508	7" x 10"	PL
129511	10" x 14"	PL
129507	7" x 10"	AL
129510	10" x 14"	AL



124195	7" x 10"	SS
124198	10" x 14"	SS
124194	7" x 10"	PL
124197	10" x 14"	PL
124193	7" x 10"	AL
124196	10" x 14"	AL



129515	7" x 10"	SS
129518	10" x 14"	SS
129514	7" x 10"	PL
129517	10" x 14"	PL
129513	7" x 10"	AL
129516	10" x 14"	AL



85427	7" x 10"	SS
85428	10" x 14"	SS
22719	7" x 10"	PL
22720	10" x 14"	PL
41283	7" x 10"	AL
41284	10" x 14"	AL



63208	2' x 24"	SS
-------	----------	----



63203	10" x 14"	SS
-------	-----------	----



63204	14" x 10"	SS
-------	-----------	----

### A New Manual on Uniform Traffic Control Devices (MUTCD) Eff. 2009 (R1-2 revised 2012)

#### Federal MUTCD Standard:

No person shall install or maintain in any area of private property used by the public any sign, signal, marking or other device intended to regulate, warn or guide traffic unless it conforms to the MUTCD.

#### Traffic Signs and Reflectivity Section 2A.0702 of MUTCDs

Stipulates that regulatory, warning, and guide signs and object markers shall be retroreflective or illuminated to show the same shape and similar color by both day and night. Most of Brady's retroreflective signs are "engineer grade". Higher intensity "Diamond Grade" signs are available as custom options.

#### All posts used for mounting must be breakaway style and mounted at new minimum mounting heights

All supports require breakaway sockets or posts. Minimum mounting height is 5' from the bottom of the sign to the top of the ground in rural or low-volume areas. Minimum mounting height is 7' from the bottom of the sign in urban or heavily traveled areas.

#### Notice: Chock Rear Wheels 1910.178(k) and (m)

When trucks are loaded and unloaded, OSHA requires the brakes to be set and wheel chocks to be placed under the rear wheels to prevent the trucks from rolling while they are boarded with a forklift or other powered industrial truck.





## Traffic Control Signs (Continued)



122903	7" x 10"	FB
122765	10" x 14"	FB
70255	24" x 36"	FB
122695	7" x 10"	SS
122619	10" x 14"	SS
122559	7" x 10"	PL
25805	10" x 14"	PL
122452	7" x 10"	AL
43382	10" x 14"	AL



129521	7" x 10"	SS
129524	10" x 14"	SS
129520	7" x 10"	PL
129523	10" x 14"	PL
129519	7" x 10"	AL
129522	10" x 14"	AL



69176	10" x 14"	FB
25806	10" x 14"	PL
43383	10" x 14"	AL



129527	7" x 10"	SS
129530	10" x 14"	SS
129526	7" x 10"	PL
129529	10" x 14"	PL
129525	7" x 10"	AL
129528	10" x 14"	AL



75115	14" x 20"	FB
25807	10" x 14"	PL
43384	10" x 14"	AL



129455	7" x 10"	SS
129458	10" x 14"	SS
129454	7" x 10"	PL
129457	10" x 14"	PL
129453	7" x 10"	AL
129456	10" x 14"	AL



73405	10" x 14"	FB
70212	14" x 20"	FB
25819	10" x 14"	PL
43396	10" x 14"	AL



89129	7" x 10"	SS
43464	10" x 14"	AL



70247	10" x 14"	FB
25823	10" x 14"	PL
43400	10" x 14"	AL



69050	10" x 14"	FB
25824	10" x 14"	PL
43401	10" x 14"	AL



69133	10" x 14"	FB
25825	10" x 14"	PL
43402	10" x 14"	AL



75096	14" x 20"	FB
25826	10" x 14"	PL
43403	10" x 14"	AL



129533	7" x 10"	SS
129536	10" x 14"	SS
129532	7" x 10"	PL
129535	10" x 14"	PL
129531	7" x 10"	AL
129534	10" x 14"	AL



75123	14" x 20"	FB
25828	10" x 14"	PL
43405	10" x 14"	AL



122855	7" x 10"	FB
47329	10" x 14"	FB
89133	7" x 10"	SS
89134	10" x 14"	SS
122523	7" x 10"	PL
25829	10" x 14"	PL
122415	7" x 10"	AL
43406	10" x 14"	AL



70457	10" x 14"	FB
25830	10" x 14"	PL
43407	10" x 14"	AL



25831	10" x 14"	PL
43408	10" x 14"	AL



25832	10" x 14"	PL
43409	10" x 14"	AL



129539	7" x 10"	SS
129542	10" x 14"	SS
129538	7" x 10"	PL
129541	10" x 14"	PL
129537	7" x 10"	AL
129540	10" x 14"	AL



89155	7" x 10"	SS
25833	10" x 14"	PL
43410	10" x 14"	AL



69539	10" x 14"	FB
25834	10" x 14"	PL
43411	10" x 14"	AL



25835	10" x 14"	PL
43412	10" x 14"	AL



73424	10" x 14"	FB
25836	10" x 14"	PL
43413	10" x 14"	AL



75234	10" x 14"	FB
25838	10" x 14"	PL
43415	10" x 14"	AL



75147	14" x 20"	FB
25839	10" x 14"	PL
43416	10" x 14"	AL



75103	14" x 20"	FB
25860	10" x 14"	PL
43437	10" x 14"	AL



25861	10" x 14"	PL
43438	10" x 14"	AL



75137	14" x 20"	FB
25868	10" x 14"	PL
43445	10" x 14"	AL



69562	7" x 17"	FB
-------	----------	----



# Traffic Control Signs

BradyID.com/s34

## Traffic Control Signs (Continued)



129545	7" x 10"	SS
129548	10" x 14"	SS
129544	7" x 10"	PL
129547	10" x 14"	PL
129543	7" x 10"	AL
129546	10" x 14"	AL



129551	7" x 10"	SS
129554	10" x 14"	SS
129550	7" x 10"	PL
129553	10" x 14"	PL
129549	7" x 10"	AL
129552	10" x 14"	AL



129557	7" x 10"	SS
129560	10" x 14"	SS
129556	7" x 10"	PL
129559	10" x 14"	PL
129555	7" x 10"	AL
129558	10" x 14"	AL



45474	14" x 20"	FB
25874	10" x 14"	PL
43451	10" x 14"	AL

**Popular Sign Materials**

**FB** - Premium Fiberglass (B-120)  
**SS** - Self-Sticking Polyester (B-302)  
**BGSS** - BradyGlo™ Self-Sticking Polyester (B-324)  
**BGPL** - BradyGlo™ Plastic (B-347)  
**PL** - Plastic (B-401)  
**AL** - Aluminum (B-555)  
**RFAL** - Reflective Aluminum (B-959)

*View all sign materials on page 25.*

**Can't find your sign?**  
*Use the Sign Legend Index on page 498 or take advantage of our custom sign options.*



80055 9' x 12" RFAL

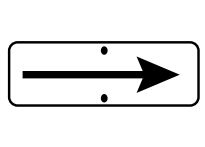

75063 5' x 14" FB



80060 9' x 12" RFAL



80101 24" x 6" RFAL  
 80103 24" x 6" RFAL  
 80102 36" x 12" RFAL  
 80104 36" x 12" RFAL



94234 24" x 24" RFAL

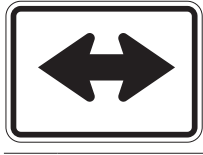

80061 9' x 12" RFAL



94163 24" x 24" RFAL



75066 24" x 24" FB



132055 7" x 10" FB  
 132056 10" x 14" FB  
 132053 7" x 10" SS  
 132054 10" x 14" SS  
 132051 7" x 10" PL  
 132052 10" x 14" PL  
 132049 7" x 10" AL  
 132050 10" x 14" AL



94307 30" x 30" RFAL



80070 30" x 30" RFAL



94222 24" x 24" RFAL

Diamond Grade  
 Reflective Aluminum  
 80068 24" x 24" B-995  
 80067 30" x 30" B-995



129644 18" x 12" SS  
 129643 18" x 12" PL  
 129642 18" x 12" AL



124388 18" x 12" SS  
 124387 18" x 12" PL  
 124386 18" x 12" AL



124580 18" x 18" PL  
 124582 24" x 24" PL  
 124579 18" x 18" AL  
 124581 24" x 24" AL



129563 18" x 12" SS  
 129562 18" x 12" PL  
 129561 18" x 12" AL



124621 7" x 17" SS  
 124620 7" x 17" PL  
 124619 7" x 17" AL



129653 18" x 12" SS  
 129652 18" x 12" PL  
 129651 18" x 12" AL



43421 10" x 14" AL



70218 18" x 24" FB  
 25845 10" x 14" PL  
 43422 10" x 14" AL



25846 10" x 14" PL  
 43423 10" x 14" AL



80097 18" x 12" RFAL



129566 18" x 12" SS  
 129565 18" x 12" PL  
 129564 18" x 12" AL



129647 18" x 12" SS  
 129646 18" x 12" PL  
 129645 18" x 12" AL

Traffic Signs

## Traffic Control Signs (Continued)



129656	18" x 12"	SS
129655	18" x 12"	PL
129654	18" x 12"	AL



129686	18" x 12"	SS
129685	18" x 12"	PL
129684	18" x 12"	AL

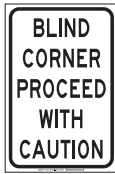

129470	18" x 12"	SS
129469	18" x 12"	PL
129468	18" x 12"	AL



70230	14" x 20"	FB
-------	-----------	----



124463	18" x 12"	SS
124462	18" x 12"	PL
124461	18" x 12"	AL



46979	7" x 10"	FB
87301	10" x 14"	FB
89131	7" x 10"	SS
89132	10" x 14"	SS
43465	10" x 14"	AL



94225	24" x 24"	RFAL
-------	-----------	------



124340	18" x 12"	SS
124339	18" x 12"	PL
124338	18" x 12"	AL



129569	18" x 12"	SS
129568	18" x 12"	PL
129567	18" x 12"	AL



129650	18" x 12"	SS
129649	18" x 12"	PL
129648	18" x 12"	AL



124592	18" x 18"	PL
124594	24" x 24"	PL
124591	18" x 18"	AL
124593	24" x 24"	AL



124201	10" x 7"	SS
124204	14" x 10"	SS
124200	10" x 7"	PL
124203	14" x 10"	PL
124199	10" x 7"	AL
124202	14" x 10"	AL



80100	18" x 12"	RFAL
-------	-----------	------



124273	24" x 36"	SS
124272	24" x 36"	PL
124271	24" x 36"	AL



129713	18" x 12"	SS
129712	18" x 12"	PL
129711	18" x 12"	AL



70257	10" x 14"	FB
25889	10" x 14"	PL
43466	10" x 14"	AL



129431	18" x 12"	SS
129430	18" x 12"	PL
129429	18" x 12"	AL



129428	18" x 12"	SS
129427	18" x 12"	PL
129426	18" x 12"	AL



75086	12" x 18"	FB
25847	10" x 14"	PL
43424	10" x 14"	AL



129572	18" x 12"	SS
129571	18" x 12"	PL
129570	18" x 12"	AL



129479	12" x 18"	SS
129478	12" x 18"	PL
129477	12" x 18"	AL



129485	7" x 10"	SS
129488	10" x 14"	SS
129484	7" x 10"	PL
129487	10" x 14"	PL
129483	7" x 10"	AL
129486	10" x 14"	AL



129716	18" x 12"	SS
129715	18" x 12"	PL
129714	18" x 12"	AL



129578	18" x 12"	SS
129577	18" x 12"	PL
129576	18" x 12"	AL



124355	18" x 12"	SS
124354	18" x 12"	PL
124353	18" x 12"	AL

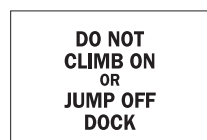

75091	10" x 14"	FB
25848	10" x 14"	PL
43425	10" x 14"	AL



129452	18" x 12"	SS
129451	18" x 12"	PL
129450	18" x 12"	AL



75094	24" x 24"	FB
-------	-----------	----



75093	30" x 30"	FB
80076	24" x 24"	RFAL
94150	30" x 30"	RFAL



High intensity reflective aluminum		
95041	30" x 30"	



# Traffic Control Signs

BradyID.com/s34

## Traffic Control Signs (Continued)



124328 18" x 12" SS  
124327 18" x 12" PL  
124326 18" x 12" AL



129620 18" x 12" SS  
129619 18" x 12" PL  
129618 18" x 12" AL



129473 18" x 12" SS  
129472 18" x 12" PL  
129471 18" x 12" AL



124460 18" x 12" SS  
124459 18" x 12" PL  
124458 18" x 12" AL

### Popular Sign Materials

**FB** - Premium Fiberglass (B-120)  
**SS** - Self-Sticking Polyester (B-302)  
**BGSS** - BradyGlo™ Self-Sticking Polyester (B-324)  
**BGPL** - BradyGlo™ Plastic (B-347)  
**PL** - Plastic (B-401)  
**AL** - Aluminum (B-555)  
**RFAL** - Reflective Aluminum (B-959)  
*View all sign materials on page 25.*

### Can't find your sign?

*Use the Sign Legend Index on page 498 or take advantage of our custom sign options.*



129719 18" x 12" SS  
129718 18" x 12" PL  
129717 18" x 12" AL



63207 10" x 14" SS



75097 10" x 14" FB  
25849 10" x 14" PL  
43426 10" x 14" AL



63210 10" x 14" SS



129584 18" x 12" SS  
129583 18" x 12" PL  
129582 18" x 12" AL



129725 18" x 12" SS  
129724 18" x 12" PL  
129723 18" x 12" AL



129581 18" x 12" SS  
129580 18" x 12" PL  
129579 18" x 12" AL



129671 18" x 12" SS  
129670 18" x 12" PL  
129669 18" x 12" AL



75101 12" x 18" FB



129674 18" x 12" SS  
129673 18" x 12" PL  
129672 18" x 12" AL



80094 18" x 18" RFAL



94180 18" x 18" RFAL



94181 18" x 18" RFAL



80091 18" x 18" RFAL



75110 18" x 18" FB



75111 18" x 18" FB  
94183 18" x 18" RFAL



75113 18" x 18" FB  
94185 18" x 18" RFAL



124406 18" x 12" SS  
124405 18" x 12" PL  
124404 18" x 12" AL



124358 18" x 12" SS  
124357 18" x 12" PL  
124356 18" x 12" AL



129491 7" x 10" SS  
129494 10" x 14" SS  
129490 7" x 10" PL  
129493 10" x 14" PL  
129489 7" x 10" AL  
129492 10" x 14" AL



124608 18" x 18" PL  
124610 24" x 24" PL  
124607 18" x 18" AL  
124609 24" x 24" AL



124352 18" x 12" SS  
124351 18" x 12" PL  
124350 18" x 12" AL



124346 18" x 12" SS  
124345 18" x 12" PL  
124344 18" x 12" AL



124349 18" x 12" SS  
124348 18" x 12" PL  
124347 18" x 12" AL



129617 18" x 12" SS  
129616 18" x 12" PL  
129615 18" x 12" AL



129587 18" x 12" SS  
129586 18" x 12" PL  
129585 18" x 12" AL



70376 18" x 12" FB  
43427 14" x 10" AL



129677 18" x 12" SS  
129676 18" x 12" PL  
129675 18" x 12" AL



69301 10" x 14" FB  
25851 10" x 14" PL  
43428 10" x 14" AL



129623 18" x 12" SS  
129622 18" x 12" PL  
129621 18" x 12" AL

## Traffic Control Signs (Continued)



94190 24" x 18" RFAL



129464 18" x 12" SS  
129463 18" x 12" PL  
129462 18" x 12" AL



129590 18" x 12" SS  
129589 18" x 12" PL  
129588 18" x 12" AL



70428 10" x 14" FB  
25852 10" x 14" PL  
43429 10" x 14" AL



129722 18" x 12" SS  
129721 18" x 12" PL  
129720 18" x 12" AL



80108 18" x 12" RFAL



124415 12" x 18" SS  
124414 12" x 18" PL  
124413 12" x 18" AL



124412 18" x 12" SS  
124411 18" x 12" PL  
124410 18" x 12" AL



124427 18" x 12" SS  
124426 18" x 12" PL  
124425 18" x 12" AL



89136 7" x 10" SS  
25890 10" x 14" PL  
43467 10" x 14" AL



124596 18" x 18" PL  
124598 24" x 24" PL  
124595 18" x 18" AL  
124597 24" x 24" AL



71178 7" x 10" FB  
25854 10" x 14" PL  
43431 10" x 14" AL



25853 7" x 10" PL  
43430 7" x 10" AL



75140 18" x 12" FB  
94116 18" x 12" RFAL  
94117 24" x 18" RFAL



124379 18" x 12" SS  
124378 18" x 12" PL  
124377 18" x 12" AL



124382 18" x 12" SS  
124381 18" x 12" PL  
124380 18" x 12" AL



75071 14" x 20" FB  
25855 10" x 14" PL  
43432 10" x 14" AL



94105 18" x 12" FB



75141 18" x 12" FB  
94119 18" x 12" RFAL  
94120 18" x 12" RFAL



75142 18" x 12" FB  
94124 18" x 12" RFAL



124319 18" x 12" SS  
124318 18" x 12" PL  
124317 18" x 12" AL



129626 18" x 12" SS  
129625 18" x 12" PL  
129624 18" x 12" AL



129698 18" x 12" SS  
129697 18" x 12" PL  
129696 18" x 12" AL



124394 18" x 12" SS  
124393 18" x 12" PL  
124392 18" x 12" AL



124310 18" x 12" SS  
124309 18" x 12" PL  
124308 18" x 12" AL



129689 18" x 12" SS  
129688 18" x 12" PL  
129687 18" x 12" AL



129692 18" x 12" SS  
129691 18" x 12" PL  
129690 18" x 12" AL



124334 18" x 12" SS  
124333 18" x 12" PL  
124332 18" x 12" AL



75143 18" x 12" FB



124325 18" x 12" SS  
124324 18" x 12" PL  
124323 18" x 12" AL



124322 18" x 12" SS  
124321 18" x 12" PL  
124320 18" x 12" AL



129734 18" x 12" SS  
129733 18" x 12" PL  
129732 18" x 12" AL



94127 18" x 12" RFAL

**Handicapped Parking Signs available on page 172.**

# Traffic Control Signs

BradyID.com/s34

## Traffic Control Signs (Continued)



129737	18" x 12"	SS
129736	18" x 12"	PL
129735	18" x 12"	AL



124313	18" x 12"	SS
124312	18" x 12"	PL
124311	18" x 12"	AL



75144	18" x 12"	FB
94130	18" x 12"	RFAL



129695	18" x 12"	SS
129694	18" x 12"	PL
129693	18" x 12"	AL

### Popular Sign Materials

**FB** - Premium Fiberglass (B-120)  
**SS** - Self-Sticking Polyester (B-302)  
**BGSS** - BradyGlo™ Self-Sticking Polyester (B-324)  
**BGPL** - BradyGlo™ Plastic (B-347)  
**PL** - Plastic (B-401)  
**AL** - Aluminum (B-555)  
**RFAL** - Reflective Aluminum (B-959)  
*View all sign materials on page 25.*

### Can't find your sign?

*Use the Sign Legend Index on page 498 or take advantage of our custom sign options.*



129746	18" x 12"	SS
129745	18" x 12"	PL
129744	18" x 12"	AL



129749	18" x 12"	SS
129748	18" x 12"	PL
129747	18" x 12"	AL



129632	18" x 12"	SS
129631	18" x 12"	PL
129630	18" x 12"	AL



124576	18" x 18"	PL
124578	24" x 24"	PL
124575	18" x 18"	AL
124577	24" x 24"	AL



129629	18" x 12"	SS
129628	18" x 12"	PL
129627	18" x 12"	AL



124337	18" x 12"	SS
124336	18" x 12"	PL
124335	18" x 12"	AL



129437	18" x 12"	SS
129436	18" x 12"	PL
129435	18" x 12"	AL



124403	18" x 12"	SS
124402	18" x 12"	PL
124401	18" x 12"	AL



89135	3-1/2" x 5"	SS
-------	-------------	----



25857	10" x 14"	PL
43434	10" x 14"	AL



129476	18" x 12"	SS
129475	18" x 12"	PL
129474	18" x 12"	AL



129635	18" x 12"	SS
129634	18" x 12"	PL
129633	18" x 12"	AL



129482	18" x 12"	SS
129481	18" x 12"	PL
129480	18" x 12"	AL



25858	7" x 10"	PL
43435	7" x 10"	AL



80098	24" x 18"	RFAL
-------	-----------	------



124409	12" x 18"	SS
124408	12" x 18"	PL
124407	12" x 18"	AL



80105	6" x 12"	RFAL
-------	----------	------

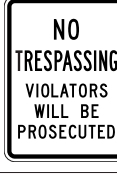

80109	18" x 12"	RFAL
-------	-----------	------



129638	18" x 12"	SS
129637	18" x 12"	PL
129636	18" x 12"	AL



94192	24" x 24"	RFAL
-------	-----------	------



124457	12" x 18"	SS
124456	12" x 18"	PL
124455	12" x 18"	AL









124442	18" x 12"	SS
124441	18" x 12"	PL
124440	18" x 12"	AL





80095	18" x 12"	RFAL
-------	-----------	------





## Traffic Control Signs (Continued)

					
70458 14" x 20" FB 25859 10" x 14" PL 43436 10" x 14" AL	124505 18" x 12" SS 124504 18" x 12" PL 124503 18" x 12" AL	129740 18" x 12" SS 129739 18" x 12" PL 129738 18" x 12" AL	129701 12" x 18" SS 129700 12" x 18" PL 129699 12" x 18" AL	75161 24" x 18" FB 94195 24" x 18" RFAL	75162 24" x 18" FB 94197 24" x 18" RFAL

					
94199 24" x 18" RFAL	129659 18" x 12" SS 129658 18" x 12" PL 129657 18" x 12" AL	129743 18" x 12" SS 129742 18" x 12" PL 129741 18" x 12" AL	129683 18" x 12" SS 129682 18" x 12" PL 129681 18" x 12" AL	129707 18" x 12" SS 129706 18" x 12" PL 129705 18" x 12" AL	75166 18" x 12" FB

					
129710 18" x 12" SS 129709 18" x 12" PL 129708 18" x 12" AL	25862 10" x 14" PL 43439 10" x 14" AL	94237 18" x 24" RFAL	129434 18" x 12" SS 129433 18" x 12" PL 129432 18" x 12" AL	129440 12" x 18" SS 129439 12" x 18" PL 129438 12" x 18" AL	129596 18" x 12" SS 129595 18" x 12" PL 129594 18" x 12" AL

					
124391 18" x 12" SS 124390 18" x 12" PL 124389 18" x 12" AL	129662 18" x 12" SS 129661 18" x 12" PL 129660 18" x 12" AL	124307 18" x 12" SS 124306 18" x 12" PL 124305 18" x 12" AL	129641 18" x 12" SS 129640 18" x 12" PL 129639 18" x 12" AL	76087 10" x 14" FB	129680 12" x 18" SS 129679 12" x 18" PL 129678 12" x 18" AL

				
124367 18" x 12" SS 124366 18" x 12" PL 124365 18" x 12" AL	80077 18" x 12" RFAL	75178 18" x 18" FB 80106 18" x 12" RFAL	129602 18" x 12" SS 129601 18" x 12" PL 129600 18" x 12" AL	75180 14" x 20" FB 43440 10" x 14" AL



# Traffic Control Signs

BradyID.com/s34

## Traffic Control Signs (Continued)



129599	18" x 12"	SS
129598	18" x 12"	PL
129597	18" x 12"	AL



124475	12" x 18"	SS
124474	12" x 18"	PL
124473	12" x 18"	AL



75155	14" x 20"	FB
25864	10" x 14"	PL



70503	10" x 28"	FB
-------	-----------	----

### Popular Sign Materials

**FB** - Premium Fiberglass (B-120)  
**SS** - Self-Sticking Polyester (B-302)  
**BGSS** - BradyGlo™ Self-Sticking Polyester (B-324)  
**BGPL** - BradyGlo™ Plastic (B-347)  
**PL** - Plastic (B-401)  
**AL** - Aluminum (B-555)  
**RFAL** - Reflective Aluminum (B-959)  
*View all sign materials on page 25.*

### Can't find your sign?

*Use the Sign Legend Index on page 498 or take advantage of our custom sign options.*



75183	7" x 20"	FB
-------	----------	----



129608	18" x 12"	SS
129607	18" x 12"	PL
129606	18" x 12"	AL



129731	18" x 12"	SS
129730	18" x 12"	PL
129729	18" x 12"	AL



129728	18" x 12"	SS
129727	18" x 12"	PL
129726	18" x 12"	AL



124370	18" x 12"	SS
124369	18" x 12"	PL
124368	18" x 12"	AL



124331	18" x 12"	SS
124330	18" x 12"	PL
124329	18" x 12"	AL



129605	18" x 12"	SS
129604	18" x 12"	PL
129603	18" x 12"	AL



129611	18" x 12"	SS
129610	18" x 12"	PL
129609	18" x 12"	AL



25865	10" x 14"	PL
43442	10" x 14"	AL



129755	18" x 12"	SS
129754	18" x 12"	PL
129753	18" x 12"	AL



75190	12" x 18"	FB
-------	-----------	----



22253	10" x 14"	PL
40816	7" x 10"	AL
40817	10" x 14"	AL



124385	18" x 12"	SS
124384	18" x 12"	PL
124383	18" x 12"	AL



129665	18" x 12"	SS
129664	18" x 12"	PL
129663	18" x 12"	AL



129443	18" x 12"	SS
129442	18" x 12"	PL
129441	18" x 12"	AL



75156	14" x 20"	FB
25869	10" x 14"	PL



124499	7" x 10"	SS
124502	10" x 14"	SS
124498	7" x 10"	PL
124501	10" x 14"	PL
124497	7" x 10"	AL
124500	10" x 14"	AL



124493	7" x 10"	SS
124496	10" x 14"	SS
124492	7" x 10"	PL
124495	10" x 14"	PL
124491	7" x 10"	AL
124494	10" x 14"	AL



132103	10" x 14"	FB
75198	14" x 20"	FB
25870	10" x 14"	PL
43447	10" x 14"	AL



70526	10" x 28"	FB
-------	-----------	----



129446	12" x 18"	SS
129445	12" x 18"	PL
129444	12" x 18"	AL



80099	24" x 24"	RFAL
-------	-----------	------



124466	18" x 12"	SS
124465	18" x 12"	PL
124464	18" x 12"	AL



## Traffic Control Signs (Continued)



94240 24" x 18" RFAL



124436 18" x 12" SS  
124435 18" x 12" PL  
124434 18" x 12" AL



129425 18" x 12" SS  
129424 18" x 12" PL  
129423 18" x 12" AL



124424 18" x 12" SS  
124423 18" x 12" PL  
124422 18" x 12" AL



124490 18" x 12" SS  
124489 18" x 12" PL  
124488 18" x 12" AL



124487 18" x 12" SS  
124486 18" x 12" PL  
124485 18" x 12" AL



124584 18" x 18" PL  
124586 24" x 24" PL  
124583 18" x 18" AL  
124585 24" x 24" AL



75199 24" x 18" FB  
94210 24" x 18" RFAL



75200 24" x 18" FB  
94211 24" x 18" RFAL



75201 24" x 18" FB  
94212 24" x 18" RFAL



76088 24" x 18" FB  
94213 24" x 18" RFAL



75203 24" x 18" FB  
94209 24" x 18" RFAL



124343 18" x 12" SS  
124342 18" x 12" PL  
124341 18" x 12" AL



75205 18" x 18" FB  
75206 24" x 24" FB  
75207 30" x 30" FB  
94142 18" x 18" RFAL  
94143 24" x 24" RFAL  
94144 30" x 30" RFAL  
94145 36" x 36" RFAL



High intensity reflective aluminum  
95043 18" x 18"  
95044 24" x 24"  
95045 30" x 30"  
95046 36" x 36"



80073 18" x 18" RFAL  
80074 30" x 30" RFAL  
80075 36" x 36" RFAL



124439 18" x 12" SS  
124438 18" x 12" PL  
124437 18" x 12" AL



124531 18" x 18" PL  
124533 24" x 24" PL  
124530 18" x 18" AL  
124532 24" x 24" AL



124451 18" x 12" SS  
124450 18" x 12" PL  
124449 18" x 12" AL



124535 18" x 18" PL  
124537 24" x 24" PL  
124534 18" x 18" AL  
124536 24" x 24" AL



124555 18" x 18" PL  
124557 24" x 24" PL  
124554 18" x 18" AL  
124556 24" x 24" AL



124421 18" x 12" SS  
124420 18" x 12" PL  
124419 18" x 12" AL



124433 18" x 12" SS  
124432 18" x 12" PL  
124431 18" x 12" AL



124539 18" x 18" PL  
124541 24" x 24" PL  
124538 18" x 18" AL  
124540 24" x 24" AL



124551 18" x 18" PL  
124553 24" x 24" PL  
124550 18" x 18" AL  
124552 24" x 24" AL



# Traffic Control Signs

BradyID.com/s34

## Traffic Control Signs (Continued)



129461	18" x 12"	SS
129460	18" x 12"	PL
129459	18" x 12"	AL



124448	18" x 12"	SS
124447	18" x 12"	PL
124446	18" x 12"	AL



124511	18" x 18"	PL
124513	24" x 24"	PL
124510	18" x 18"	AL
124512	24" x 24"	AL



76090	12" x 15"	FB
-------	-----------	----

### Popular Sign Materials

**FB** - Premium Fiberglass (B-120)  
**SS** - Self-Sticking Polyester (B-302)  
**BGSS** - BradyGlo™ Self-Sticking Polyester (B-324)  
**BGPL** - BradyGlo™ Plastic (B-347)  
**PL** - Plastic (B-401)  
**AL** - Aluminum (B-555)  
**RFAL** - Reflective Aluminum (B-959)  
*View all sign materials on page 25.*

### Can't find your sign?

*Use the Sign Legend Index on page 498 or take advantage of our custom sign options.*



124519	18" x 18"	PL
124521	24" x 24"	PL
124518	18" x 18"	AL
124520	24" x 24"	AL



124397	18" x 12"	SS
124396	18" x 12"	PL
124395	18" x 12"	AL



124523	18" x 18"	PL
124525	24" x 24"	PL
124522	18" x 18"	AL
124524	24" x 24"	AL



124527	18" x 18"	PL
124529	24" x 24"	PL
124526	18" x 18"	AL
124528	24" x 24"	AL



124430	18" x 12"	SS
124429	18" x 12"	PL
124428	18" x 12"	AL



124515	18" x 18"	PL
124517	24" x 24"	PL
124514	18" x 18"	AL
124516	24" x 24"	AL



124559	18" x 18"	PL
124561	24" x 24"	PL
124558	18" x 18"	AL
124560	24" x 24"	AL



124543	18" x 18"	PL
124545	24" x 24"	PL
124542	18" x 18"	AL
124544	24" x 24"	AL



124507	18" x 18"	PL
124509	24" x 24"	PL
124506	18" x 18"	AL
124508	24" x 24"	AL



124547	18" x 18"	PL
124549	24" x 24"	PL
124546	18" x 18"	AL
124548	24" x 24"	AL



129752	18" x 12"	SS
129751	18" x 12"	PL
129750	18" x 12"	AL



129467	12" x 18"	SS
129466	12" x 18"	PL
129465	12" x 18"	AL



129668	18" x 12"	SS
129667	18" x 12"	PL
129666	18" x 12"	AL



129704	18" x 12"	SS
129703	18" x 12"	PL
129702	18" x 12"	AL



124481	18" x 12"	SS
124480	18" x 12"	PL
124479	18" x 12"	AL



124484	18" x 12"	SS
124483	18" x 12"	PL
124482	18" x 12"	AL



124478	18" x 12"	SS
124477	18" x 12"	PL
124476	18" x 12"	AL



94106	6" x 12"	FB
94123	6" x 12"	RFAL

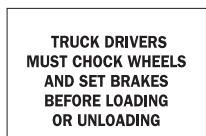

75215	10" x 14"	FB
25871	10" x 14"	PL
43448	10" x 14"	AL

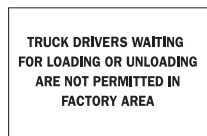

70562	14" x 20"	FB
25872	10" x 14"	PL
43449	10" x 14"	AL



124418	12" x 18"	SS
124417	12" x 18"	PL
124416	12" x 18"	AL



129614	18" x 12"	SS
129613	18" x 12"	PL
129612	18" x 12"	AL



94218	18" x 24"	RFAL
-------	-----------	------

## Traffic Control Signs (Continued)



124469	12" x 18"	SS
124468	12" x 18"	PL
124467	12" x 18"	AL



124472	12" x 18"	SS
124471	12" x 18"	PL
124470	12" x 18"	AL



124600	18" x 18"	PL
124602	24" x 24"	PL
124599	18" x 18"	AL
124601	24" x 24"	AL



124445	18" x 12"	SS
124444	18" x 12"	PL
124443	18" x 12"	AL



129497	7" x 10"	SS
129500	10" x 14"	SS
129496	7" x 10"	PL
129499	10" x 14"	PL
129495	7" x 10"	AL
129498	10" x 14"	AL



129449	12" x 18"	SS
129448	12" x 18"	PL
129447	12" x 18"	AL



75219	14" x 20"	FB
43450	10" x 14"	AL



124316	18" x 12"	SS
124315	18" x 12"	PL
124314	18" x 12"	AL



75226	12" x 18"	FB
-------	-----------	----



124376	18" x 12"	SS
124375	18" x 12"	PL
124374	18" x 12"	AL



124373	18" x 12"	SS
124372	18" x 12"	PL
124371	18" x 12"	AL



80078	18" x 12"	RFAL
-------	-----------	------



75227	18" x 12"	FB
-------	-----------	----



124588	18" x 18"	PL
124590	24" x 24"	PL
124587	18" x 18"	AL
124589	24" x 24"	AL



124604	18" x 18"	PL
124606	24" x 24"	PL
124603	18" x 18"	AL
124605	24" x 24"	AL



124454	18" x 12"	SS
124453	18" x 12"	PL
124452	18" x 12"	AL



75157	10" x 14"	FB
75158	14" x 20"	FB
25875	10" x 14"	PL
43452	10" x 14"	AL



94152	18" x 30"	RFAL
-------	-----------	------



High intensity reflective aluminum		
95040	18" x 30"	



75062	24"	FB
80071	18"	RFAL
94148	24"	RFAL
80072	30"	RFAL



High intensity reflective aluminum		
95039	30"	
95042	36"	



124616	18"	PL
124618	24"	PL
124615	18"	RFAL
124617	24"	RFAL



124400	18" x 12"	SS
124399	18" x 12"	PL
124398	18" x 12"	AL



124612	18"	PL
124614	24"	PL
124611	18"	RFAL
124613	24"	RFAL



# Safety Sign Sliders

BradyID.com/s34



## Safety Sign Sliders

Effectively Communicate Multiple Safety Messages

Brady Safety Sign Sliders help you keep employees and visitors safe with the most current and important messages. The highly visual displays ensure that anyone entering the facility or work area is aware of the necessary safety precautions. Custom or stock sliding inserts can easily be added, removed or reordered to update safety and awareness messages quickly and cost-effectively.

### Sign Slider Materials

PL - Plastic (B-401)

AL - Aluminum (B-555)

View all sign materials on page 25.

Sign Accessories



### Wall Mount Boards

Catalog #	Description	Material	Sign Capacity	Size	Qty
140747	Single Wall Mount	Plastic	4	36" x 24"	1
140746	Single Wall Mount	Plastic	6	50" x 24"	1
140745	Single Wall Mount	Plastic	8	64" x 24"	1
140736	Single Wall Mount	Plastic	11	74" x 24"	1
140744	Single Wall Mount	Aluminum	4	36" x 24"	1
140743	Single Wall Mount	Aluminum	6	50" x 24"	1
140742	Single Wall Mount	Aluminum	8	64" x 24"	1
140741	Single Wall Mount	Aluminum	11	74" x 24"	1

### 3-Side Free Standing Boards

Catalog #	Description	Material	Sign Capacity	Size	Qty
140740	3-Side Free Standing	Plastic	4	36" x 24"	1
140739	3-Side Free Standing	Plastic	6	50" x 24"	1
140738	3-Side Free Standing	Plastic	8	64" x 24"	1
140737	3-Side Free Standing	Plastic	11	74" x 24"	1

### Mandatory Action Sign Sliders

DUST MASKS ARE REQUIRED AT ALL TIMES	DUST MASKS ARE REQUIRED IN THIS AREA	EVERY PERSON HAS THE RESPONSIBILITY AND AUTHORITY TO STOP WORK IN AN UNSAFE SITUATION	HARD HAT, SAFETY GLASSES AND HEARING PROTECTION MUST BE WORN	HARD HATS AND SAFETY GLASSES WITH CLEAR LENSES AND SIDE SHIELDS MUST BE WORN AT ALL TIMES
140777 6" x 23.875" PL 140822 6" x 23.875" AL	140803 6" x 23.875" PL 140823 6" x 23.875" AL	140751 6" x 23.875" PL 140797 6" x 23.875" AL	140757 6" x 23.875" PL 140801 6" x 23.875" AL	140753 6" x 23.875" PL 140795 6" x 23.875" AL
HARD HATS MUST BE WORN AT ALL TIMES	HARD HATS MUST BE WORN IN THIS AREA	HEARING PROTECTION AND SAFETY GLASSES MUST BE WORN	HEARING PROTECTION MUST BE WORN AT ALL TIMES	HEARING PROTECTION MUST BE WORN IN THIS AREA
140783 6" x 23.875" PL 140828 6" x 23.875" AL	140782 6" x 23.875" PL 140829 6" x 23.875" AL	140784 6" x 23.875" PL 140796 6" x 23.875" AL	140752 6" x 23.875" PL 140830 6" x 23.875" AL	140802 6" x 23.875" PL 140831 6" x 23.875" AL
PROPER HAND PROTECTION IS REQUIRED FOR ALL TASKS EXCEPT WHEN WORKING WITH ROTATING EQUIPMENT	REPORT ALL INJURIES OR UNSAFE CONDITIONS IMMEDIATELY	RESPIRATORS ARE REQUIRED AT ALL TIMES	RESPIRATORS ARE REQUIRED IN THIS AREA	SAFETY FOOTWEAR IS REQUIRED AT ALL TIMES
140750 6" x 23.875" PL 140798 6" x 23.875" AL	140773 6" x 23.875" PL 140819 6" x 23.875" AL	140774 6" x 23.875" PL 140820 6" x 23.875" AL	140776 6" x 23.875" PL 140821 6" x 23.875" AL	140780 6" x 23.875" PL 140826 6" x 23.875" AL



140781 6" x 23.875" PL  
140827 6" x 23.875" AL



140785 6" x 23.875" PL  
140763 6" x 23.875" AL



140786 6" x 23.875" PL  
140832 6" x 23.875" AL



140748 6" x 23.875" PL  
140800 6" x 23.875" AL



140778 6" x 23.875" PL  
140824 6" x 23.875" AL



140779 6" x 23.875" PL  
140825 6" x 23.875" AL



140779 6" x 23.875" PL  
140825 6" x 23.875" AL



140749 6" x 23.875" PL  
140799 6" x 23.875" AL

## Prohibition Sign Sliders



140758 6" x 23.875" PL  
140791 6" x 23.875" AL



140767 6" x 23.875" PL  
140812 6" x 23.875" AL



140768 6" x 23.875" PL  
140813 6" x 23.875" AL



140769 6" x 23.875" PL  
140814 6" x 23.875" AL



140804 6" x 23.875" PL  
140815 6" x 23.875" AL



140759 6" x 23.875" PL  
140790 6" x 23.875" AL



140760 6" x 23.875" PL  
140789 6" x 23.875" AL



140761 6" x 23.875" PL  
140788 6" x 23.875" AL



140772 6" x 23.875" PL  
140818 6" x 23.875" AL



140771 6" x 23.875" PL  
140817 6" x 23.875" AL

## Caution Sign Sliders



140765 6" x 23.875" PL  
140810 6" x 23.875" AL



140754 6" x 23.875" B-401  
140811 6" x 23.875" B-555



140766 6" x 23.875" PL  
140794 6" x 23.875" AL



140755 6" x 23.875" PL  
140793 6" x 23.875" AL



140770 6" x 23.875" PL  
140816 6" x 23.875" AL



140762 3" x 23.875" PL  
140787 3" x 23.875" AL



140807 3" x 23.875" PL  
140808 4" x 23.875" PL  
140805 3" x 23.875" AL  
140806 4" x 23.875" AL

## Environmental Sign Sliders



140764 6" x 23.875" PL  
140809 6" x 23.875" AL



140756 6" x 23.875" PL  
140792 6" x 23.875" AL

**Custom Sign Sliders**

Contact Brady Customer Service to create custom Sign Sliders for your facility.



BradyID.com/s34



## U-Channel Sign Posts

- Baked green enamel finish on hot-rolled, high-tensile strength steel
- Weight: two pounds per linear foot
- 3/8" holes, 1" on center
- Hardware sold separately below

Catalog #	Description	Size
95047	U-Channel Sign Post	6'
97204	U-Channel Sign Post	8'
97205	U-Channel Sign Post	10'
97206	U-Channel Sign Post	12'



## Vandal-Proof Tufnut™ for U-Channel Post

- Plated steel nut secures tightly to prevent sign theft
- 5/16" nut for use with U-Channel Sign Posts (sold separately)

Catalog #	Description
97211	2 Bolts, 2 Washers, 3 Tufnuts™



## Mounting Tape

- Indoor/Outdoor, double-faced, 1/16" thick foam tape
- Bonds well to rough, irregular surfaces
- Service range: 50°F to 180°F

Catalog #	Description	Size	Qty.
78272	Roll Mounted	0.5" x 108'	1
78273	Roll Mounted	0.75" x 108'	1
19811	Roll Mounted	1" x 108'	1
97200	Card Mounted	0.75" x 4.5"	4

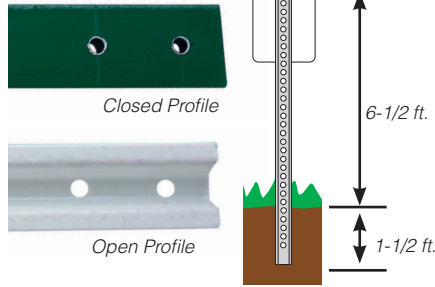

## Tuff-N-Light™ U-Channel Post

- Ideal for traffic and industrial signage
- Closed profile posts are 6 times torsionally stronger than steel posts
- Open profile for up to 12"x18" signs

Catalog #	Description	Size	Color
97208	Closed profile	8'	White
97210	Closed profile	8'	Green
97207	Open profile	8'	White
97209	Open profile	8'	Green



## NuLock I™ Fastener for Tuff-N-Light™ Posts

- Maintenance free nylon fastener
- Installation & removal require no tools
- Use with Tuff-N-Light Sign Posts

Catalog #	Description
90912	NuLock I - 2 stems and 2 clips



## Tape Strips

- Use for mounting signs or bin panels to rough surfaces
- Double-coated foam strips have adhesive on both sides

Catalog #	Description	Size	Qty.
58300	Tape Strips	1" x 4"	10

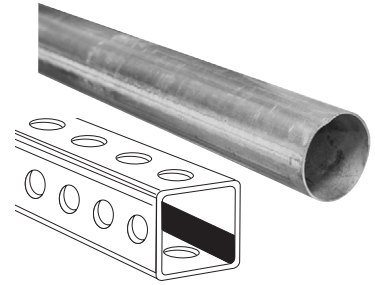

## Galvanized Posts

- Galvanized steel posts are manufactured of a high tensile steel and resist corrosion
- Square posts have 7/6" diameter holes on 1" centers that run the full length of all four sides

Catalog #	Shape	Length	Size
78995	Round	8'	2-3/8" dia. 16 gauge
78996	Round	10'	2-3/8" dia. 16 gauge
78997	Round	12'	2-3/8" dia. 16 gauge
78998	Square	8'	2" x 2" 14 gauge
78999	Square	10'	2" x 2" 14 gauge
79000	Square	12'	2" x 2" 14 gauge



## NuLock II™ Fastener for Tuff-N-Light™ Posts

- Nylon fastener with adjustable tightening
- Reusable or cut off slip wings for permanent applications
- Use with Tuff-N-Light Sign Posts

Catalog #	Description
90913	NuLock II - 2 stems and 2 clips



## Magnetic Strips

- Magnetic mounting strips with pressure sensitive adhesive on one side

Catalog #	Description	Size	Qty.
58301	Magnetic Strips	1" x 4"	10

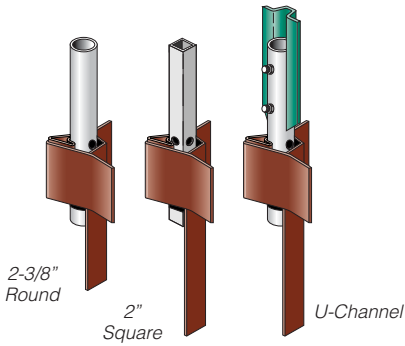

## V-Loc Breakaways

- Helps comply with MUTCD
- Install in concrete, asphalt or dirt
- Strong steel fins hold the socket securely in the ground resisting movement from wind vibration
- Allows post to break off cleanly at ground level
- Posts are easily replaced by removing the locking wedge and placing new post in socket

Catalog #	Shape	Qty.
78991	2-3/8" Round w/ wedge	1
78992	2" Square w/ wedge	1
78993	U-Channel w/ wedge & adaptor	1



## Post Driver

- Made of heavy duty steel with black finish to withstand harsh conditions
- 30" long and 4" diameter.

Catalog #	Description	Qty.
87982	Post Driver	1



## Movable Sign Posts

- For permanent or temporary use
- Black baked enamel finish
- Small Size:  
Base: 14" dia., 16 lb cast iron base  
Post: 48" length, 1" dia., pre-drilled for signs that are 18"x12"
- Large Size:  
Base: 17" dia., 35 lb cast iron base  
Post: 48" length, 1.5" dia., pre-drilled for signs that are 18"x18", 24" x 18" or 24" x 24"

Catalog #	Description	Color	Qty.
86336	Small: 16 lb base	Black	1
86345	Large: 35 lb base	Black	1



## Rubber Sign Post

- Moveable post for indoors or outdoors
- 100% recycled rubber base won't chip, crack or rust
- PVC posts accommodate 18" x 12" or 24" x 24" signs

Catalog #	Color	Base	Qty.
103566	White	20 lb	1
103567	White	30 lb	1
103568	White	60 lb	1



## Sign Base

- Ideal for temporary use
- Securely mounts with three expansion bolts
- Accepts U-channel posts (sold separately)
- Cast aluminum base is 15" in diameter and includes post mount stub and hardware

Catalog #	Description	Qty.
86339	15" Diameter Base	1



## Flexible Sign Post

- Polypropylene sign post is equipped with reactive springs to endure collisions
- Can be mounted to asphalt or concrete
- Sign mounting hardware and post installation kit included

Catalog #	Color	Height	Base	Qty.
103569	White	5'	8" x 8"	1
103570	Yellow	5'	8" x 8"	1



# Sign Accessories

BradyID.com/s34



## Fence Sign Brackets

- Easily attaches signs to fences
- Brackets are constructed of 14 gauge steel with a green baked enamel finish
- Mounting hardware included

Catalog #	Description
86337	17" Bracket for 18"x12" or 18"x18"
86338	22" Bracket for 12"x18" or 24"x24"

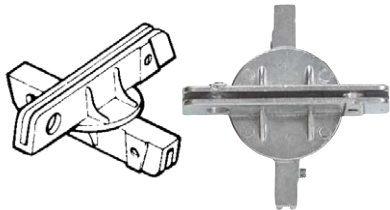

## Street Sign 4-Way Cross Piece

- Mount on top of another street sign for additional sign

Catalog #	Description	Qty.
56681	4-Way Cross Piece	1

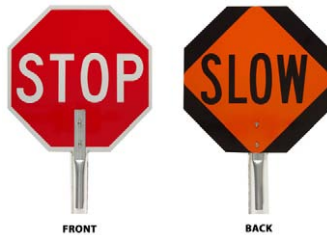

## Traffic Control Paddles

- Made of durable aluminum
- 18" octagons weight 2 lbs
- 5 foot aluminum handle also available

Catalog #	Description	Qty.
57754	Stop (red/white); Slow (orange/black)	1
57755	Stop (red/white) on both sides	1
55775	Stop (red/white); Go (green/white)	1
55784	5' Handle Extension	1

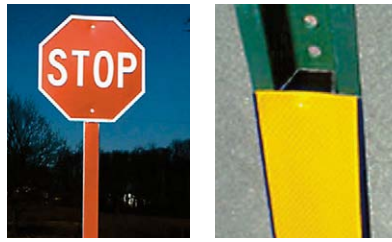

## BriteSide™ Reflective Panels

- Create a reflective u-channel post
- Highly-reflective diamond-grade material
- Mounting hardware included

Catalog #	Description	Color	Size	Qty.
95036	Reflective Panel	Blue	3' x 6'	1
95037	Reflective Panel	Red	3' x 6'	1
95038	Reflective Panel	Yellow	3' x 6'	1



## Street Sign Tubular Post Top

- Attach to top of post to mount street sign

Catalog #	Description	Qty.
56687	Tubular Post Top	1



## Emergency Triangles

- Reflector for day and night visibility
- Solid weighted base for stability
- 13 lbs each

Catalog #	Description	Qty.
57892	Emergency Triangles	3



## Stainless Steel Coil

- Strapping coil in dispensing box for attaching street sign accessories to sign posts

Catalog #	Description	Qty.
56694	Stainless Steel Coil	1

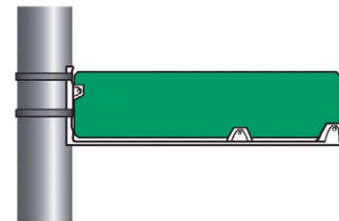

## Street Sign Jumbo Wing Bracket

- 21" bracket can meet the challenges of mounting 9" high street name blades

Catalog #	Description	Qty.
56688	Wing Bracket	1



## Slow Moving Vehicle Sign

- For vehicles traveling 25 mph or less
- Hardware not included

Catalog #	Size	Material	Qty.
57893	14" x 16"	Vinyl	1
57894	14" x 16"	Steel	1
57895	14" x 16"	Aluminum	1



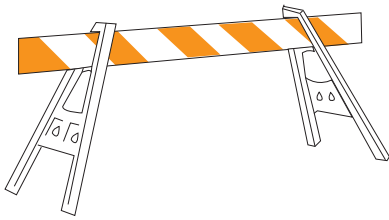

## A-Frame Barricades

- Made from impact-resistant polyethylene
- Legs are 42" high and base is 28" wide

Catalog #	Description	Length	Qty.
57073	Single Board	6'	1
57445	Single Board	8'	1
57446	Single Board	10'	1
57502	Double Board	6'	1
57593	Double Board	8'	1
57594	Double Board	10'	1



## Traffic Barrel

- Designed to "break-away" from base if struck
- Add up to 53 lbs of sand for wind resistance

Catalog #	Description	Qty.
57771	40" tall and 4" high base	1



## Pavement Tape

- Apply to clean, dry pavement
- Instantly conforms to the road surface
- High retro-directive reflectivity
- Exceeds federal specification requirements for permanent tape

Catalog #	Description	Color	Size	Qty.
78263	Pavement Tape	White	4' x 150'	1
78264	Pavement Tape	Yellow	4' x 150'	1



## Metal Folding Barricades

- Made of high density polyethylene
- **Style One:** Reflective sheeting on upper and lower panels
- **Style Two:** Reflective sheeting on upper and lower panels

Catalog #	Style	Size	Qty.
57596	Metal - Style One	42" x 24"	1
57597	Metal - Style Two	42" x 24"	1



## Traffic Cones

- Meets MUTCD specifications
- Vinyl construction assures flexible, yet rugged durability

Catalog #	Description	Size	Qty.
80111	18" Cone	18"	1
80112	24" Cone	24"	1



## Temporary Pavement Tape

- Foil-backed vinyl, coated with sand and reflective beads
- Bonds temporarily to clean, dry surfaces making it ideal for low traffic areas

Catalog #	Description	Color	Size	Qty.
78261	Economy Tape	White	4' x 150'	1
78262	Economy Tape	Yellow	4' x 150'	1



Narrow style shown.

## Plastic Folding Barricades

- Made of rugged polyethylene
- **Style One:** Reflective sheeting on upper and lower panels
- **Style Two:** Reflective sheeting on upper and lower panels

Catalog #	Style	Size	Qty.
57599	Plastic - Style One	45" x 25"	1
57627	Plastic - Style Two	45" x 25"	1
57630	Plastic - Style One Narrow	36" x 16"	1



Cone sold separately.

## Traffic Cone Sleeves

- Durable vinyl sleeve fit snugly over your traffic cones and are flexible and waterproof

Catalog #	Legend	Size	Qty.
101972	Danger Vehicle May Become Energized	19" x 9.398"	1



View all Road Construction Signs on page 171.



# CUSTOM SIGNS

## Create signs unique to your facility

Brady understands that sometimes you need a sign that is unique to your own facility. With Brady's wide variety of custom sign options, we have the ability to create a sign with exactly the message you need, in the material and size you want.

- Custom text
- Custom graphics
- Common sizes
- Variety of materials
- No minimum order
- Fast turnaround



Worried About Custom Costs?

Brady's **"Same as Stock"** Pricing Offers You Big Savings

Contact Brady to create your own custom signs today!

## Safety Sign Headers

ANSI and OSHA specify that safety signs must indicate and define specific hazards that, without identification, may lead to accidental injury to workers, customers or the general public. The standard headers and definitions are listed below.

DANGER	WARNING	CAUTION	NOTICE	SAFETY
<ul style="list-style-type: none"> <li>Indicates an imminently hazardous situation which if not avoided, will result in death or serious injury.</li> <li>Limited to most extreme situations.</li> <li>Not used for property damage hazards unless personal injury risk to this level is also involved.</li> </ul>	<ul style="list-style-type: none"> <li>Indicates a potentially hazardous situation which, if not avoided, could result in death or serious injury.</li> <li>Not used for property damage hazards unless personal injury risk is also involved.</li> <li>Appropriate for outside of the area or on the exterior of enclosures containing a danger-level hazard.</li> </ul>	<ul style="list-style-type: none"> <li>Indicates a potentially hazardous which, if not avoided, may result in minor or moderate injury.</li> <li>May be used to alert against unsafe practices that may cause property damage.</li> </ul>	<ul style="list-style-type: none"> <li>Indicates a statement of company policy directly or indirectly related to the safety of personnel or protection of property.</li> <li>Should not be associated with a hazard or hazardous situation, and shall not be used in place of DANGER, WARNING or CAUTION.</li> </ul>	<ul style="list-style-type: none"> <li>Indicate general instructions relative to safe work practices or indicate the location of safety equipment (e.g. eye wash station)</li> </ul>

## Sign Material Guide

Brady offers a sign material for virtually every application. Whether the sign is used indoors or outdoors, in mild or harsh environments, we have the material to match your application.

Material Type	Description	Protected Graphics	For Outdoor Use	Average Outdoor Durability	Chemical Resistance	Abrasion Resistance	Max. Temp	Thickness (in.)
<b>Flexible Sign Materials</b>								
Adhesive	B-302 High Performance Polyester	✓	✓	8 yrs	Excellent	Excellent	230° F (100°C)	.006-.010"
Adhesive	B-324 BradyGlo™ Photoluminescent Polyester	-	-	-	Good	Good	176°F (80°C)	.008"
Adhesive	B-485 Polyester Film	✓	-	-	Good	Good	122°F (50°C)	.011"
Adhesive	B-523 Photoluminescent Polyester Film with Aggressive Adhesive	-	-	-	Good	Good	176°F (80°C)	.0096"
Adhesive	B-534 Polyester Floor Sign with Anti-Skid Tread	✓	-	-	Good	Good	130°F (54°C)	.011"
Adhesive	B-808 BradyGlo™ Anti-Slip Polyester Floor Sign	✓	-	-	Good	Good	158°F (70°C)	.017"
Adhesive	B-819 Anti-Slip Vinyl Floor Sign	✓	-	-	Good	Good	158°F (70°C)	.012"
Adhesive	B-928 Write-On Vinyl with Cold Temp Adhesive	-	✓	2 yrs	Good	Good	176°F (80°C)	.005"
Adhesive	B-946 Self-Sticking Vinyl	-	✓	10 yrs	Fair	Good	180°F (82°C)	.004"
Adhesive	B-984 Photoluminescent Polyester Film	-	-	-	Good	Good	176°F (80°C)	.013"
Adhesive	B-997 BradyLite® Reflective Vinyl	-	✓	4-6 yrs	Good	Good	200°F (93°C)	.007"
Non-Adhesive	B-101 Polycoated Tagstock	-	-	-	Good	Good	158°F (70°C)	.010"
Non-Adhesive	B-586 Eco-Friendly Paperboard	-	-	-	Good	Good	175°F (80°C)	.060"
Non-Adhesive	B-811 Magnetic Vinyl	-	✓	2-4 yrs	Good	Good	158°F (70°C)	.025"
<b>Rigid Sign Materials</b>								
Metal	B-555 Aluminum	✓	✓	8 yrs	Excellent	Excellent	230°F (110°C)	.040-.090"
Metal	B-959 Reflective Aluminum	-	✓	4-8 yrs	Good	Good	175°F (80°C)	.040-.080"
Metal	B-986 Photoluminescent Polyester Film on Aluminum	-	-	-	Good	Good	175°F (80°C)	.049"
Metal	B-995 Diamond-Grade™ Reflective Aluminum	-	✓	7 yrs	Good	Good	212°F (100°C)	.097"
Fiberglass	B-120 Premium Fiberglass	✓	✓	25 yrs	Excellent	Excellent	193°F (90°C)	.100"
Fiberglass	B-140 Polyester on Fiberglass	✓	✓	8 yrs	Excellent	Excellent	175°F (79°C)	.070"
Fiberglass	B-320 Sub Surface Printed Lexan on Fiberglass	✓	✓	8 yrs	Good	Good	175°F (79°C)	.07"
Fiberglass	B-382 Sub Surface Printed Polycarbonate on Fiberglass	✓	✓	8 yrs	Good	Good	175°F (79°C)	.090"
Plastic	B-1 Thermoset Plastic	-	✓	8 yrs	Good	Good	193°F (89°C)	.062"
Plastic	B-347 BradyGlo™ Phosphorescent Polyester on Polystyrene	-	-	-	Good	Good	175°F (79°C)	.068"
Plastic	B-355 BradyGlo Steel Encased Photoluminescent Plastic	-	-	-	Good	Good	122°F (50°C)	.250"
Plastic	B-401 Polystyrene Plastic	✓	✓	5 yrs	Good	Good	175°F (79°C)	.060"
Plastic	B-450 Polyethylene Plastic	-	-	-	Good	Good	180°F (82°C)	.055"
Plastic	B-493 Plastic V-Shaped Signs	-	✓	2 yrs	Good	Good	193°F (90°C)	.100"
Plastic	B-563 Eco-Friendly Plastic (70% Post Consumer Waste)	-	✓	5 yrs	Good	Good	185°F (85°C)	.055"
Plastic	B-793 Polystyrene	-	✓	1-3 yrs	Poor	Good	165°F (74°C)	.156"
Plastic	B-836 Temporary Sign Fluted Polypropylene	-	✓	1 yr	Good	Good	130°F (54°C)	.156"
Plastic	B-985 Photoluminescent Polyester Film on Polystyrene	-	-	-	Good	Good	175°F (80°C)	.069"



# Custom Signs

BradyID.com/s34

## Custom Sign Pictograms

Pictograms provide a universal way to communicate warnings to all employees and visitors, regardless of language or demographic and can provide a better understanding of hazards. Pictograms provide an easy-to-understand alternative to bi/tri-lingual signs, which can often be difficult to read. Use the following pictograms on your custom signs to communicate the right message for your application.

Custom Signs



## Custom Sign Pictograms (Continued)

 Picto #: 152	 Picto #: 153	 Picto #: 154	 Picto #: 158	 Picto #: 159	 Picto #: 160	 Picto #: 162	 Picto #: 166	 Picto #: 170	 Picto #: 171	 Picto #: 174
 Picto #: 176	 Picto #: 181	 Picto #: 190	 Picto #: 191	 Picto #: 192	 Picto #: 198	 Picto #: 206	 Picto #: 210	 Picto #: 215	 Picto #: 218	 Picto #: 219
 Picto #: 227	 Picto #: 229	 Picto #: 230	 Picto #: 234	 Picto #: 235	 Picto #: 236	 Picto #: 237	 Picto #: 238	 Picto #: 333	 Picto #: 338	 Picto #: 347
 Picto #: 348	 Picto #: 358	 Picto #: 361	 Picto #: 362	 Picto #: 368	 Picto #: 375	 Picto #: 376	 Picto #: 377	 Picto #: 383	 Picto #: 388	 Picto #: 389
 Picto #: 396	 Picto #: 397	 Picto #: 400	 Picto #: 404	 Picto #: 411	 Picto #: 413	 Picto #: 418	 Picto #: 419	 Picto #: 420	 Picto #: 429	 Picto #: 436
 Picto #: 437	 Picto #: 438	 Picto #: 439	 Picto #: 440	 Picto #: 447	 Picto #: 448	 Picto #: 449	 Picto #: 450	 Picto #: 451	 Picto #: 452	 Picto #: 453
 Picto #: 454	 Picto #: 456	 Picto #: 457	 Picto #: 458	 Picto #: 459	 Picto #: 460	 Picto #: 461	 Picto #: 462	 Picto #: 463	 Picto #: 464	 Picto #: 465
 Picto #: 470	 Picto #: 471	 Picto #: 472	 Picto #: 473	 Picto #: 476	 Picto #: 478	 Picto #: 480	 Picto #: 481	 Picto #: 482	 Picto #: 487	 Picto #: 492
 Picto #: 493	 Picto #: 495	 Picto #: 496	 Picto #: 497	 Picto #: 498	 Picto #: 500	 Picto #: 505	 Picto #: 508	 Picto #: 517	 Picto #: 518	 Picto #: 529
 Picto #: 530	 Picto #: 531	 Picto #: 532	 Picto #: 535	 Picto #: 536	 Picto #: 539	 Picto #: 540	 Picto #: 543	 Picto #: 544	 Picto #: 559	 Picto #: 560
 Picto #: 566	 Picto #: 572	 Picto #: 584	 Picto #: 585	 Picto #: 589	 Picto #: 590	 Picto #: 592	 Picto #: 593	 Picto #: 598	 Picto #: 600	



## Custom Sign Order Form

Order     Quote     Artwork Attached    Ship Via. \_\_\_\_\_    P.O. # or Request # \_\_\_\_\_

### Customer Information

Company Name: \_\_\_\_\_ Name: \_\_\_\_\_  
 Address1: \_\_\_\_\_ Phone #: \_\_\_\_\_  
 Address2: \_\_\_\_\_ Fax #: \_\_\_\_\_  
 City: \_\_\_\_\_ State: \_\_\_\_\_ Zip: \_\_\_\_\_  
 Email: \_\_\_\_\_

### Distributor Information

Distributor: \_\_\_\_\_ Contact Name: \_\_\_\_\_  
 Account: \_\_\_\_\_ Fax #: \_\_\_\_\_ Phone #: \_\_\_\_\_

### Sign Specifications

#### Sign Material

- B-120 Premium Fiberglass
- B-302 Self-Sticking Polyester
- B-324 Self-Sticking BradyGlo™
- B-347 BradyGlo™ Plastic
- B-401 Plastic
- B-555 Aluminum
- Other: B-\_\_\_\_\_ *(View all sign materials on page 25)*

#### Size and Quantity (H x W)

- |   |   |
|---|---|
| <input type="checkbox"/> 3-1/2"x5" Qty. _____ | <input type="checkbox"/> 10"x14" Qty. _____   |
| <input type="checkbox"/> 4"x6" Qty. _____     | <input type="checkbox"/> 12"x18" Qty. _____   |
| <input type="checkbox"/> 5"x7" Qty. _____     | <input type="checkbox"/> 14"x20" Qty. _____   |
| <input type="checkbox"/> 7"x10" Qty. _____    | <input type="checkbox"/> 18"x24" Qty. _____   |
| <input type="checkbox"/> 9"x12" Qty. _____    | <input type="checkbox"/> ___"x___" Qty. _____ |

### Sign Content

#### Sign Header

- |  |  |  |   |  |
|--|--|--|---|--|
| <input type="checkbox"/>  | <input type="checkbox"/>  | <input type="checkbox"/>  | <input type="checkbox"/>  | <input type="checkbox"/>  |
| <input type="checkbox"/>  | <input type="checkbox"/>  | <input type="checkbox"/>  | <input type="checkbox"/>  | <input type="checkbox"/>  |

#### No Header *(Fill in below)*

Background Color: \_\_\_\_\_  
 Lower Text Color: \_\_\_\_\_  
*(Lower text will be black unless specified)*

#### Pictogram # \_\_\_\_\_ *(View Previous Page For Available Pictograms)*

#### Finishing:

- No Holes
- 4 Corner Holes
- Foam Tape
- 2 Post Holes
- 2 Side Holes
- Other *(Show placement in box)*

#### Draw sign layout and text in box below:

Please Include The Following Three Items:  
 1. Header    2. Picto Placement (If applicable)    3. Finishing Hole Placement

## Custom Tank & Vessel Signs Order Form

When ordering a Custom GHS Tank & Vessel Sign from Brady, please have a Safety Data Sheet (SDS) in hand to fill in the form. The SDS, supplied from your chemical manufacturer must be up-to-date with GHS elements. All required label elements that are needed to fill this form out are found in sections 1-3 in your chemical SDS. Once complete, return this form to BradyUSAQuotes@BradyCorp.com or fax to 1-800-292-2289.

### Customer Information

Company Name: \_\_\_\_\_ Name: \_\_\_\_\_  
 Address 1: \_\_\_\_\_ Phone #: \_\_\_\_\_  
 Address 2: \_\_\_\_\_ Fax #: \_\_\_\_\_  
 City: \_\_\_\_\_ State: \_\_\_\_\_ Zip: \_\_\_\_\_  
 Email: \_\_\_\_\_

### Distributor Information

Distributor: \_\_\_\_\_ Contact Name: \_\_\_\_\_  
 Account: \_\_\_\_\_ Fax #: \_\_\_\_\_ Phone #: \_\_\_\_\_

### Sign Specifications

Sign Material	Quantity and Size
<input type="checkbox"/> B-120 Fiberglass	<input type="checkbox"/> 7" x 5" Qty. _____
<input type="checkbox"/> B-302 Self-Sticking	<input type="checkbox"/> 14" x 10" Qty. _____
<input type="checkbox"/> B-401 Vinyl Plastic	<input type="checkbox"/> 20" x 14" Qty. _____

#### Sign Format



GHS Format 1     GHS Format 2     GHS Format 3

### Sign Content

Tank #: \_\_\_\_\_

Chemical Name: \_\_\_\_\_

Signal Word: \_\_\_\_\_  
 (DANGER or WARNING)

Hazard Statements: \_\_\_\_\_  
 Located on your Safety Data Sheet, please include H-Code if available. i.e. H100

Precautionary Statements/First Aid: \_\_\_\_\_  
 Located on your Safety Data Sheet, please include P-Code if available. i.e. P100

**GHS Pictograms:**  
 Located on your Safety Data Sheet, indicate pictogram number below:  
 1 Minimum / Maximum 4

Diamond 1: \_\_\_\_\_ Diamond 3: \_\_\_\_\_

Diamond 2: \_\_\_\_\_ Diamond 4: \_\_\_\_\_



**NFPA Rating:**  
 Health \_\_\_\_ Fire \_\_\_\_ Instability \_\_\_\_ Specific \_\_\_\_

**HMIG Rating:**  
 Health \_\_\_\_ Fire \_\_\_\_ Instability \_\_\_\_ Specific \_\_\_\_

**Protective Equipment Required Pictograms:**  
 Choose up to 6 icons.

PPE 1: \_\_\_\_\_ PPE 3: \_\_\_\_\_ PPE 5: \_\_\_\_\_  
 PPE 2: \_\_\_\_\_ PPE 4: \_\_\_\_\_ PPE 6: \_\_\_\_\_



**Additional Sign Content:**  
 DOT Class: \_\_\_\_\_  
 DOT ID #: \_\_\_\_\_  
 CAS #: \_\_\_\_\_  
 Reach Authorization #: \_\_\_\_\_  
 Internal Reference #: \_\_\_\_\_  
 Chemical Manufacturer: \_\_\_\_\_  
 Chemical Manufacturer Name: \_\_\_\_\_  
 Chemical Manufacturer Address: \_\_\_\_\_  
 Emergency Contact Phone #: \_\_\_\_\_  
 Confined Space Entry Permit Required?  Yes  No



# Globally Harmonized System (GHS)

BradyID.com/ghs

## Hazard Communication OSHA Standards and GHS (Globally Harmonized System) Compliance

OSHA's recent update to its Hazard Communication Standard changes the requirements when it comes to chemical labeling and mandatory employee training. This means you need to know exactly what the Global Harmonized System (GHS) is and how it affects your business. That's where we come in. As your trusted business advisor for 100 years, Brady offers the information you need and a wide variety of products and services to help you transition to the new system and stay compliant.



### What is GHS?

#### GHS = Globally Harmonized System of Classification & Labeling of Chemicals

GHS is a system that's been created by the United Nations for standardizing the classification and labeling of chemicals throughout the world. In the United States, OSHA is enforcing GHS by adopting it into its Hazard Communication Standard (CFR 1910.1200):

- Defining environmental, physical and health hazards from chemicals
- Communicating these hazards and protective measures on standardized labels and Safety Data Sheets (SDS)

**Under the new GHS format, labels will have 6 elements and SDS sheets have 16 elements.**

### Why does GHS matter?

#### Chemical import/export means big business

Globally, the production and use of chemicals is a more than \$1.7 trillion per year enterprise (\$400 billion in the U.S. alone). Chemical labeling has appeared differently based on different regional requirements. With such an impact on the world economy, it's critical that the import and export of chemicals be made as safe and efficient as possible. The GHS standard globally helps keep workers safe and informed of chemical hazards.



#### Number of Federal OSHA HazCom Violations



*HazComm was #2 on OSHA's Top 10 list of most frequently cited standards for 2013.*

(In Fiscal Years)



## Compliance Timeline and Checklist

- Update annual chemical inventory
- Schedule periodic re-training on pictograms, labels and Safety Data Sheets (SDS). Brady offers both in-person and DVD-based HazCom training solutions
- Post GHS signs, posters, and hand out wallet cards
- Separate SDS and Material Safety Data Sheet (MSDS) binders and sheets as part of management system. This will allow you to re-label chemicals with SDS information and determine which sheets you haven't received yet

- Review and ensure that all MSDS have been converted to SDS format
- Audit all containers for compliance with updated regulations. Establish policy to control improperly labeled containers

**December 1, 2013**

Employers must train employees on the new label elements and Safety Data Sheet (SDS) format.

**June 1, 2015**

Chemical manufacturers, importers and distributors reclassify chemicals, send SDS & labels in GHS format.

**December 1, 2015**

Distributors send only updated SDS & labels.

**June 1, 2016**

Employer full compliance deadline.

- Identify secondary labeling needs and procedures
- Purchase GHS labeling equipment and supplies
- Implement labeling procedures (create your own labels or order preprinted versions) based on new SDS sheets
- Archive MSDS for determined amount of time (Brady recommends 30 years)
- Re-train on GHS as well as your existing HazCom system (NFPA/HMIS) until full conversion to GHS is complete

- Ensure your training policy is in place as internal product changes. Annual training is always recommended

- Note any new hazards identified on SDS and potential Personal Protection Equipment (PPE) changes. As new chemicals are brought into your facility, new hazard and PPE needs may be created
- Ensure your written HazCom program is updated and reflects all internal and external changes

# Globally Harmonized System (GHS)

BradyID.com/ghs

## GHS Label Guide

This guide shows a compliant HazCom label with each of the six label elements that make-up a GHS label.

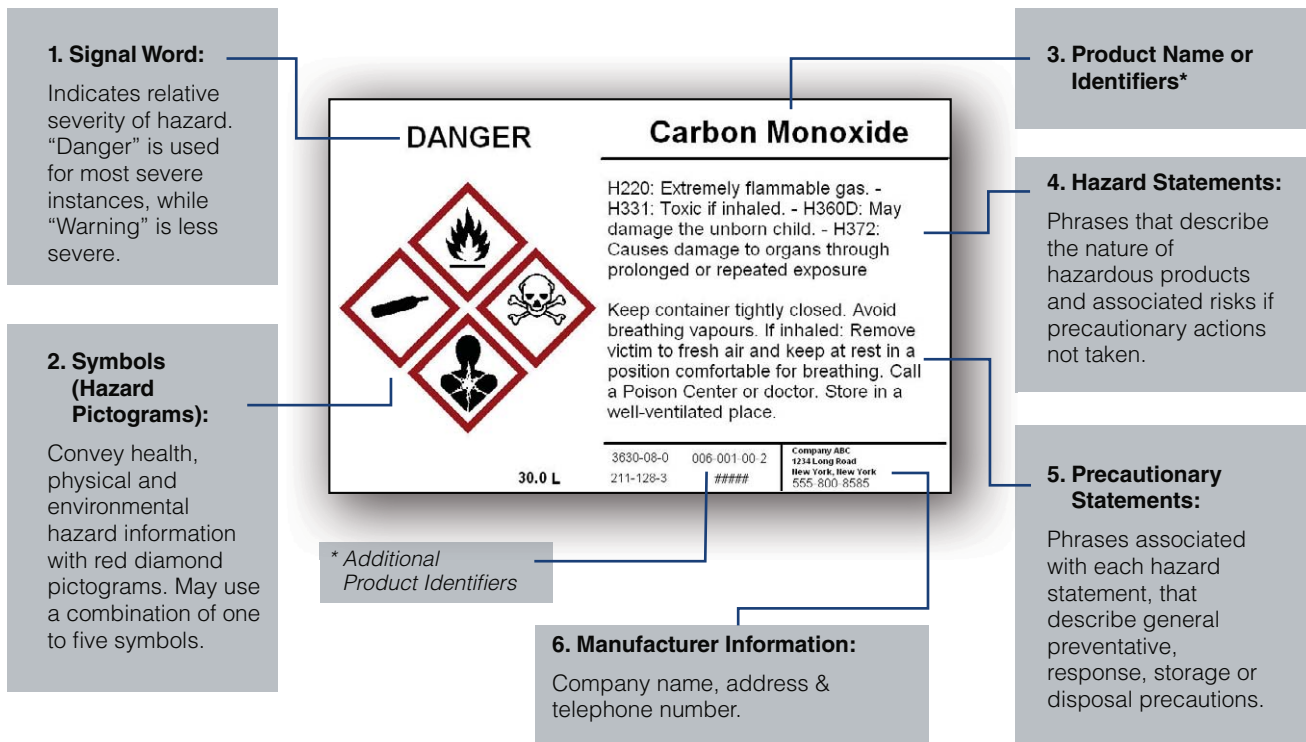

## 16 Elements of Safety Data Sheets (SDS)

OSHA's updated Hazard Communication Standard requires that the chemical manufacturer, distributor or importer provide Safety Data Sheets (SDS) for each hazardous chemical to communicate information on these hazards. Each SDS is required to be presented in a consistent format, including the following sections:

- **Section 1: Identification**  
Chemical and recommended uses, and supplier contact information.
- **Section 2: Hazard(s) Identification**  
Hazards of chemical and the appropriate warning information.
- **Section 3: Composition/Information of Ingredients**  
Ingredients contained in the products.
- **Section 4: First-Aid Measures**  
Initial care that should be given by an untrained responder to an individual exposed to a chemical.
- **Section 5: Fire-Fighting Measures**  
Recommendations for fighting a fire caused by the chemical.
- **Section 6: Accidental Release Measures**  
Appropriate response to spills, leaks or releases, including containment and cleanup practices.
- **Section 7: Handling and Storage**  
Safe handling practices and conditions for safe storage of chemicals.
- **Section 8: Exposure Controls/Personal Protection**  
Exposure limits, engineering controls and personal protective measures to minimize worker exposure.
- **Section 9: Physical and Chemical Properties**  
Physical and chemical properties associated with the substance or mixture.
- **Section 10: Stability and Reactivity**  
Reactivity hazards and stability information.
- **Section 11: Toxicology Information**  
Toxicological and health effects information or indicates such data is unavailable.
- **Section 12: Ecological Information (non-mandatory)**  
Environmental impact of the chemical(s) if it were released to the environment.
- **Section 13: Disposal Considerations (non-mandatory)**  
Proper disposal practices, recycling or reclamation and safe handling practices.
- **Section 14: Transport Information (non-mandatory)**  
Classification information for shipping and transporting.
- **Section 15: Regulatory Information (non-mandatory)**  
Safety, health and environmental regulations specific for the product that is not indicated anywhere else on the SDS.
- **Section 16: Other Information**  
When the SDS was prepared or when the last known revision was made.

## GHS Symbols Guide

The new GHS symbols, also known as hazard pictograms, each serve a special purpose and are used to identify hazardous products. While the environmental pictogram was not mandated by OSHA, it is listed because it may be required by other agencies for labeling.

Three hazard classes:

Chemical / Physical Risk

Health Risk

Environmental Risk



### Corrosive

(Corrosion Pictogram)

Identifies chemicals with the following hazards:

- Skin corrosion/burns
- Eye damage
- Corrosive metals



### Gas Cylinder

(Cylinder Pictogram)

Identifies chemicals with the following hazards:

- Gasses under pressure



### Oxidizing

(Flame Over Circle Pictogram)

Identifies chemicals with the following hazards:

- Oxidizers



### Flame

(Flame Pictogram)

Identifies chemicals with the following hazards:

- Flammables
- Pyrophorics
- Self-heating
- Emits flammable gas
- Self-reactives
- Organic peroxides



### Explosive

(Exploding Bomb Pictogram)

Identifies chemicals with the following hazards:

- Explosives
- Self-reactives
- Organic peroxides



### Acute Toxic

(Exclamation Mark Pictogram)

Identifies chemicals with the following hazards:

- Irritant (skin & eye)
- Skin sensitizer
- Acute toxicity (harmful)
- \* This symbol is used for fatal and severe toxicity.
- Narcotic effects
- Respiratory tract infection
- Hazardous ozone layer (non mandatory)



### Health Hazard

(Health Hazard Pictogram)

Identifies chemicals with the following hazards:

- Carcinogen
- Mutagenicity
- Reproductive toxicity
- Respiratory sensitizer
- Target organ toxicity
- Aspiration toxicity



### Severe Toxic

(Skull & Cross Bones Pictogram)

Identifies chemicals with the following hazards:

- Acute toxicity (fatal or toxic)\*

\* GHS Acute Toxic symbol is used for less severe toxicity.



### Environmental

(not mandated in U.S.)

(Environment Pictogram)

Identifies chemicals with the following hazards:

- Aquatic toxicity



### Learn More: GHS Whitepapers and Webinar

- Introduction to the Globally Harmonized System Whitepaper
- Five Steps to Compliant Hazard Communication Program Whitepaper
- GHS & Hazard Communication Webinar

To download, visit [www.BradyID.com/ghs](http://www.BradyID.com/ghs)



# Globally Harmonized System (GHS)

BradyID.com/ghs

## GHS Pictogram Labels

• Pre-printed die cut labels identify hazardous products for chemical risks, health risks and environmental risks in accordance to the United Nations' universal approach to classifying and communicating chemical hazards.



### GHS Explosive

- Explosives, self-reactives, organic peroxides

#### Explosive Legend

Catalog #	Size	Material	Qty.
<b>B-7569 Vinyl</b>			
118815	5/8"	B-7569 Vinyl	39/card
118816	1"	B-7569 Vinyl	16/card
118817	2"	B-7569 Vinyl	4/card
<b>B-235 Paper</b>			
118869	5/8"	B-235 Paper	39/card
118870	1"	B-235 Paper	16/card
118871	2"	B-235 Paper	4/card



### GHS Gas Pressure

- Gases under pressure

#### Gas Pressure Legend

Catalog #	Size	Material	Qty.
<b>B-7569 Vinyl</b>			
118833	5/8"	B-7569 Vinyl	39/card
118834	1"	B-7569 Vinyl	16/card
118835	2"	B-7569 Vinyl	4/card
<b>B-235 Paper</b>			
118887	5/8"	B-235 Paper	39/card
118888	1"	B-235 Paper	16/card
118889	2"	B-235 Paper	4/card



### GHS Health Danger

- Carcinogens, respiratory sensitizers, reproductive toxicity, target organ toxicity, germ cell mutagens

#### Health Danger Legend

Catalog #	Size	Material	Qty.
<b>B-7569 Vinyl</b>			
118851	5/8"	B-7569 Vinyl	39/card
118852	1"	B-7569 Vinyl	16/card
118853	2"	B-7569 Vinyl	4/card
<b>B-235 Paper</b>			
118905	5/8"	B-235 Paper	39/card
118906	1"	B-235 Paper	16/card
118907	2"	B-235 Paper	4/card



### GHS Flammable

- Flammable gases, liquids, and solids; pyrophorics; self-reactives; self-heating

#### Flammable Legend

Catalog #	Size	Material	Qty.
<b>B-7569 Vinyl</b>			
118821	5/8"	B-7569 Vinyl	39/card
118822	1"	B-7569 Vinyl	16/card
118823	2"	B-7569 Vinyl	4/card
<b>B-235 Paper</b>			
118875	5/8"	B-235 Paper	39/card
118876	1"	B-235 Paper	16/card
118877	2"	B-235 Paper	4/card



### GHS Corrosive

- Corrosives

#### Corrosive Legend

Catalog #	Size	Material	Qty.
<b>B-7569 Vinyl</b>			
118839	5/8"	B-7569 Vinyl	39/card
118840	1"	B-7569 Vinyl	16/card
118841	2"	B-7569 Vinyl	4/card
<b>B-235 Paper</b>			
118893	5/8"	B-235 Paper	39/card
118894	1"	B-235 Paper	16/card
118895	2"	B-235 Paper	4/card



### GHS Acute Toxic

- Acute toxicity, skin and eye irritation, skin sensitizers

#### Acute Toxic Legend

Catalog #	Size	Material	Qty.
<b>B-7569 Vinyl</b>			
118857	5/8"	B-7569 Vinyl	39/card
118858	1"	B-7569 Vinyl	16/card
118859	2"	B-7569 Vinyl	4/card
<b>B-235 Paper</b>			
118911	5/8"	B-235 Paper	39/card
118912	1"	B-235 Paper	16/card
118913	2"	B-235 Paper	4/card



### GHS Oxidizing

- Oxidizers, organic peroxides

#### Oxidizing Legend

Catalog #	Size	Material	Qty.
<b>B-7569 Vinyl</b>			
118827	5/8"	B-7569 Vinyl	39/card
118828	1"	B-7569 Vinyl	16/card
118829	2"	B-7569 Vinyl	4/card
<b>B-235 Paper</b>			
118881	5/8"	B-235 Paper	39/card
118882	1"	B-235 Paper	16/card
118883	2"	B-235 Paper	4/card



### GHS Severe Toxic

- Severe toxicity

#### Severe Toxic Legend

Catalog #	Size	Material	Qty.
<b>B-7569 Vinyl</b>			
118845	5/8"	B-7569 Vinyl	39/card
118846	1"	B-7569 Vinyl	16/card
118847	2"	B-7569 Vinyl	4/card
<b>B-235 Paper</b>			
118899	5/8"	B-235 Paper	39/card
118900	1"	B-235 Paper	16/card
118901	2"	B-235 Paper	4/card



### GHS Environmental

- Aquatic toxicity

#### Environmental Legend

Catalog #	Size	Material	Qty.
<b>B-7569 Vinyl</b>			
118863	5/8"	B-7569 Vinyl	39/card
118864	1"	B-7569 Vinyl	16/card
118865	2"	B-7569 Vinyl	4/card
<b>B-235 Paper</b>			
118917	5/8"	B-235 Paper	39/card
118918	1"	B-235 Paper	16/card
118919	2"	B-235 Paper	4/card



## MarkWare™ Software now includes a GHS / CLP Label Module

- 18 pre-formatted label layouts and approved GHS symbols are built-in
- User selects approved pre-worded hazard statements and GHS symbols which then automatically populates into layout – no need to type everything in
- Prompts for additional variable data which then auto-populates into layout
- Choose a second language and MarkWare auto-populates in the second language
- Contains templates for Globalmark®, BBP®31 and BBP®33 Label Printers

Catalog #	Description
20700	MarkWare™ Software

Already a MarkWare Software user? Upgrade your current MarkWare by visiting [BradyID.com/markware](http://BradyID.com/markware) and going to "Software Downloads"



## Hazard Communications Training Programs

OSHA is mandating that all employees covered under the 29 CFR 1910.1200 regulation to have initial training on the new hazard communication changes and the GHS elements by December 1, 2013. Brady has now launched two DVD-based training programs to help you fulfill that requirement.



### GHS Hazcom Training Program

- 2 video program on the new GHS elements can help fulfill an initial training requirement by focusing on:
  - Understanding the new GHS label elements
  - Identifying the new GHS pictograms
  - Reading and interpreting GHS Safety Data Sheets
- Includes: DVD with 2 videos (14 min GHS Labeling Video and 10 min GHS Safety Data Sheets Video), instructor's guide, employee quiz, PowerPoint presentations and 5 Employee Handbooks

Catalog #	Description	Qty.
132428	GHS Hazcom Training Program Kit	1
133160	Bilingual GHS Hazcom Training Program Kit - English/Spanish presentations - English-only handbook (hardcopy format) - Spanish-only handbook (printable PDF format)	1
132429	Additional GHS Hazcom Training Employee Handbooks (English)	5

### Hazcom Comprehensive Training Program

- Fully comprehensive training program on OSHA's Hazard Communication Regulation (1910.1200) including GHS
- Can be used to fulfill a typical annual refresher requirement
- Program is intended to ensure employees:
  - understand types of hazardous materials are in the workplace
  - are able to read and understand labels and Safety Data Sheets
  - are able to understand how to safely use hazardous materials
- Includes: DVD, instructor's guide, employee quiz, PowerPoint presentations, and 5 Employee Handbooks

Catalog #	Description	Qty.
132457	Hazcom Comprehensive Training Program Kit	1
132458	Additional Hazcom Comprehensive Training Employee Handbooks	5

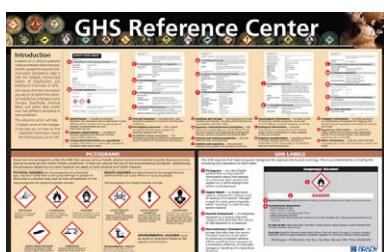

### GHS Reference Center Poster

- This all-inclusive, large format poster gets worker's attention and combines many of the most important changes into one easy-to-read format
- Includes detailed information on:
  - Safety Data Sheet (SDS) format
  - GHS-formatted label elements
  - GHS Hazard Pictograms

Catalog #	Description	Size	Qty.
133209	GHS Reference Center Poster	25.5" x 39.5"	1 each



### GHS Pictograms Wallet Cards

- Wallet Cards outline all 9 of the new GHS Hazard Pictograms
- A great training aid to help employees become familiar with the new hazard pictograms, and as a handy reference for when the new GHS labels are entering your facility
- Made of laminated cardstock

Catalog #	Description	Size	Qty.
133208	GHS Pictograms Wallet Card	2.1" x 3.4"	10/pk



### GHS Intro Poster Pack

- Set of 3 informational posters puts critical GHS information in different parts of your facility and promotes employee understanding
- Posters outline:
  - An overview of the Globally Harmonized System of Classification and Labeling of Chemicals
  - Information regarding the new Safety Data Sheets format and outline
  - Information regarding the new GHS-formatted label elements

Catalog #	Description	Size	Qty.
133207	GHS Intro Posters	17" x 22"	1 set of 3



# Custom GHS Labels Order Form

BradyID.com/ghs

## Custom GHS Label Form

When ordering a Custom GHS Label from Brady, please have a Safety Data Sheet (SDS) in hand to fill in the form. The SDS, supplied from your chemical manufacturer must be up-to-date with GHS elements. All required label elements that are needed to fill this form out are found in sections 1-3 in your chemical SDS. (Once label has been created a proof is required.) Once complete, return this form to BradyUSAQuotes@BradyCorp.com or fax to 1-800-292-2289.

### Customer Information

Company Name: \_\_\_\_\_ Name: \_\_\_\_\_  
Address 1: \_\_\_\_\_ Phone #: \_\_\_\_\_  
Address 2: \_\_\_\_\_ Fax #: \_\_\_\_\_  
City: \_\_\_\_\_ State: \_\_\_\_\_ Zip: \_\_\_\_\_  
Email: \_\_\_\_\_

### Distributor Information

Distributor: \_\_\_\_\_ Contact Name: \_\_\_\_\_  
Account #: \_\_\_\_\_ Fax #: \_\_\_\_\_ Phone #: \_\_\_\_\_

### Label Specifications

#### Label Material

- B-302 Self-Sticking Polyester
- B-946 Vinyl
- B-7569 Economy Vinyl
- B-235 Coated Paper

#### Quantity and Size

(minimum order qty. of 25)

- 3" x 5" Qty. \_\_\_\_\_
- 4" x 6" Qty. \_\_\_\_\_
- 4.5" x 7" Qty. \_\_\_\_\_

#### Label Package

- Roll Form (100 labels minimum)
- Individual Labels

### Label Content

#### Chemical/Product Name:

\_\_\_\_\_

#### Signal Word:

(DANGER or WARNING)

\_\_\_\_\_

#### Capacity:

\_\_\_\_\_

#### Units:

\_\_\_\_\_

#### Hazard Statements:

Located on your Safety Data Sheet, please include H-Code if available. i.e. H100

\_\_\_\_\_

\_\_\_\_\_

\_\_\_\_\_

#### Precautionary Statements/First Aid:

Located on your Safety Data Sheet, please include P-Code if available. i.e. P100

\_\_\_\_\_

\_\_\_\_\_

\_\_\_\_\_

#### GHS Pictograms:

Locate on your Safety Data Sheet and indicate pictogram number below:  
1 Minimum / Maximum 4

Diamond 1: \_\_\_\_\_ Diamond 3: \_\_\_\_\_

Diamond 2: \_\_\_\_\_ Diamond 4: \_\_\_\_\_



1. Corrosive 2. Severe Toxic 3. Explosive 4. Flammable 5. Environmental



6. Acute Toxic 7. Oxidizing 8. Gas Pressure 9. Health

#### Additional Label Content:

EC #: \_\_\_\_\_

CAS #: \_\_\_\_\_

Index #: \_\_\_\_\_

Reach Authorization #: \_\_\_\_\_

Internal Reference #: \_\_\_\_\_

Chemical Manufacturer Name: \_\_\_\_\_

Chemical Manufacturer Address: \_\_\_\_\_

\_\_\_\_\_

Emergency Contact Phone #: \_\_\_\_\_

Multiple Languages Requested\* \_\_\_\_\_

\* Please indicate languages requested, then provide the necessary translations to the customer service rep after you have received the initial English proof.

# Custom Tank & Vessel Signs Order Form

BradyID.com/ghs

## Custom Tank & Vessel Signs Order Form

When ordering a Custom GHS Tank & Vessel Sign from Brady, please have a Safety Data Sheet (SDS) in hand to fill in the form. The SDS, supplied from your chemical manufacturer must be up-to-date with GHS elements. All required label elements that are needed to fill this form out are found in sections 1-3 in your chemical SDS. (Once label has been created a proof is required.) Once complete, return this form to BradyUSAQuotes@BradyCorp.com or fax to 1-800-292-2289.

### Customer Information

Company Name: \_\_\_\_\_ Name: \_\_\_\_\_  
Address 1: \_\_\_\_\_ Phone #: \_\_\_\_\_  
Address 2: \_\_\_\_\_ Fax #: \_\_\_\_\_  
City: \_\_\_\_\_ State: \_\_\_\_\_ Zip: \_\_\_\_\_  
Email: \_\_\_\_\_

### Distributor Information

Distributor: \_\_\_\_\_ Contact Name: \_\_\_\_\_  
Account #: \_\_\_\_\_ Fax #: \_\_\_\_\_ Phone #: \_\_\_\_\_

### Sign Specifications

Sign Material	Quantity and Size
<input type="checkbox"/> B-120 Fiberglass	<input type="checkbox"/> 10" x 7" Qty. _____
<input type="checkbox"/> B-302 Self-Sticking	<input type="checkbox"/> 14" x 10" Qty. _____
<input type="checkbox"/> B-401 Vinyl Plastic	<input type="checkbox"/> 20" x 14" Qty. _____

#### Sign Format



Format 1



Format 2



Format 3

### Sign Content

Tank #: \_\_\_\_\_

Chemical Name: \_\_\_\_\_

Signal Word: \_\_\_\_\_  
(DANGER or WARNING)

Hazard Statements: \_\_\_\_\_  
*Located on your Safety Data Sheet, please include H-Code if available. i.e. H100*

Precautionary Statements/First Aid: \_\_\_\_\_  
*Located on your Safety Data Sheet, please include P-Code if available. i.e. P100*

GHS Pictograms:  
*Located on your Safety Data Sheet, indicate pictogram number below:  
1 Minimum / Maximum 4*

Diamond 1: \_\_\_\_\_ Diamond 3: \_\_\_\_\_

Diamond 2: \_\_\_\_\_ Diamond 4: \_\_\_\_\_



1. Corrosive 2. Severe Toxic 3. Explosive 4. Flammable 5. Environmental



6. Acute Toxic 7. Oxidizing 8. Gas Pressure 9. Health

NFPA Rating:  
Health \_\_\_\_\_ Fire \_\_\_\_\_ Instability \_\_\_\_\_ Specific \_\_\_\_\_

HMIG Rating:  
Health \_\_\_\_\_ Fire \_\_\_\_\_ Instability \_\_\_\_\_ Specific \_\_\_\_\_

#### Protective Equipment Required Pictograms:

*Choose up to 6 icons.*

PPE 1: \_\_\_\_\_ PPE 3: \_\_\_\_\_ PPE 5: \_\_\_\_\_

PPE 2: \_\_\_\_\_ PPE 4: \_\_\_\_\_ PPE 6: \_\_\_\_\_



A. Safety Glasses



B. Rubber Gloves



C. Face Shield



D. Chemical Goggles



E. S.C.B.A.



F. Dust Mask



G. Rubber Boots



H. Apron



I. Respirator



J. Chemical Suit



K. Boots/Gloves



L. Eyewash/Shower

#### Additional Sign Content:

DOT Class: \_\_\_\_\_

DOT ID #: \_\_\_\_\_

CAS #: \_\_\_\_\_

Reach Authorization #: \_\_\_\_\_

Internal Reference #: \_\_\_\_\_

Chemical Manufacturer: \_\_\_\_\_

Chemical Manufacturer Name: \_\_\_\_\_

Chemical Manufacturer Address: \_\_\_\_\_

Emergency Contact Phone #: \_\_\_\_\_

Confined Space Entry Permit Required?  Yes  No



# Hazard Communication (RTK)

BradyID.com/s34



NFPA



HMIG Color Bar



NFPA



HMIG Color Bar

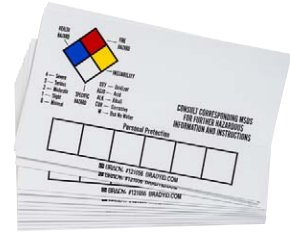

Safety & Regulatory

## 5" x 3" Container Labels

- Economical option for secondary container labeling
- Choose from paper or vinyl materials in NFPA Diamond or HMIG Color Bar formats

Catalog #	Material	Format	Qty.
99175	Paper	HMIG Color Bar	500
121164	Vinyl	HMIG Color Bar	500
99195	Paper	NFPA	500
121146	Vinyl	NFPA	500

## 2" x 1-1/4" Lab Labels

- Paper or vinyl materials in NFPA Diamond or HMIG Color Bar formats
- Write-on labels allow you to customize your message.

Catalog #	Material	Format	Qty.
58268	Paper	HMIG Color Bar	500
121161	Vinyl	HMIG Color Bar	500
99199	Paper	NFPA	500
121163	Vinyl	NFPA	500

## 3" x 5" Write-On RTK Labels

- Customize these Blank R-T-K Labels by writing your own message on them and adding R-T-K pictograms.

Catalog #	Material	Format	Qty.
121056	Vinyl	NFPA	50



## Blank NFPA Placards

- Meets NFPA's Code No. 704M and Federal Standard 313
- Place on potentially hazardous equip.
- Use with Gothic style Quik-Align® numbers and letters (sold separately)

Catalog #	Description	Size	Qty.
58656	B-120 Fiberglass	11" sq.	1
58510	B-120 Fiberglass	16" sq.	1
58500	B-946 Vinyl	2.5" sq.	10
58501	B-946 Vinyl	5" sq.	10
58502	B-946 Vinyl	7.5" sq.	10
58503	B-946 Vinyl	10" sq.	10
58504	B-946 Vinyl	15" sq.	10
58272	B-997 Reflective	5" sq.	10
58273	B-997 Reflective	7.5" sq.	10
58274	B-997 Reflective	10" sq.	10



## NFPA Placard Kits

- Vinyl kits includes:
  - 10 blank NFPA placards
  - 10 characters each of 0 - 4, W, ☸, OXY, ACID, COR and ALK
- Fiberglass kits includes:
  - 1 blank NFPA placard
  - 10 characters each of 0 - 4, W, ☸, OXY, ACID, COR and ALK

Catalog #	Description	Size	Qty.
50053	B946 Vinyl	10" sq	4"
50055	B120 Fiberglass	11" sq	4"
50054	B946 Vinyl	15" sq	6"
50056	B120 Fiberglass	16" sq	6"

## NFPA Diamond Labels

- Available in rolls of 500

Catalog #	Description	Size	Qty.
53072	Vinyl	6" x 6"	500



## NFPA Information Placards

- Placards graphically explain the NFPA Hazard Identification Coding System

Catalog #	Description	Size	Qty.
78788	B-120 Fiberglass	10" x 14"	1
58511	B-946 Self-Sticking	10" x 14"	1
76415	B-946 Self-Sticking	10" x 14"	1



## HMIG Labels Station

- Acrylic Station has six 3/4" pockets for holding sheet labels, one 5" dowel to hold label rolls and a pen holder
- Provides hazard rating information printed on board

Catalog #	Description	Size	Qty.
PD674E	Large HMIG Label Station	11" x 18"	1

HEALTH	FLAMMABILITY	INSTABILITY	PROTECTIVE EQUIPMENT
A	B	C	A
B	C	D	B
C	D	E	C
D	E	F	D
E	F	F	E
F	F	F	F

## HMIG Self-Laminating Labels

- Label and overlay all-in-one self-adhesive polyester label includes polyester laminate cover
- Write in the rating on the left side. Right side shows the index for required ppe

Catalog #	Description	Size	Qty.
60332	Self-Lam Label	2" x 3-1/2"	25
60333	Self-Lam Label	3" x 5"	25

HEALTH	FLAMMABILITY	REACTIVE INSTABILITY	SPECIFIC HAZARD
1	1	1	1
2	2	2	2
3	3	3	3
4	4	4	4

## RTK Wallet Card

- Handy reference of the NFPA Hazard identification Coding System
- Ideal for distribution to employees following formal hazard communication training

Catalog #	Description	Size	Qty.
58515	English	2-1/8" x 3-3/8"	25
89257	Spanish	2-1/8" x 3-3/8"	25



## Hazardous Waste Labels

- Labels comply with all current Federal regulations regarding identification of hazardous waste materials for transportation off-site



Catalog #	Description	Material	Size	Qty.
121155	Hazardous Waste	Vinyl	6" x 6"	50
121151	Hazardous Waste	Vinyl	6" x 6"	100
121156	Haz. Waste - New Jersey Specific	Vinyl	6" x 6"	50
121144	Haz. Waste - New Jersey Specific	Vinyl	6" x 6"	100
121157	Haz. Waste - California Specific	Vinyl	6" x 6"	50
121152	Haz. Waste - California Specific	Vinyl	6" x 6"	100
121158	Non-Regulated Waste	Vinyl	6" x 6"	50
121153	Non-Regulated Waste	Vinyl	6" x 6"	100
121159	Non-Hazardous Waste	Vinyl	6" x 6"	50
121154	Non-Hazardous Waste	Vinyl	6" x 6"	100
60447	Non-Hazardous Waste	Paper	6" x 6"	100
121064	Hazardous Waste	Vinyl	4" x 6"	50
121063	Hazardous Waste	Vinyl	4" x 6"	100
60445	Hazardous Waste	Paper	4" x 6"	100

## PCB Markers

- Use PCB warning labels and signs to satisfy EPA 40 CFR Part 761 Subpart C for identification of PCB contaminated equipment or to mark PCB waste

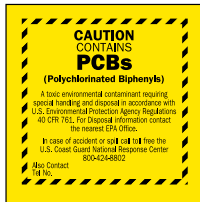

Catalog #	Description	Size	Qty.
87026	EPA Reference 761.44(a)	6"x6" Paper	50
87031	EPA Reference 761.44(a)	4"x4" Vinyl	50
87028	EPA Reference 761.44(a)	6"x6" Vinyl	50

## Universal Waste Labels

- Meet universal waste requirements, 40 CFR 273.14
- Standard package: 100 labels

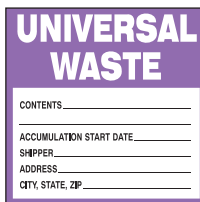

Catalog #	Description	Size	Qty.
121437	Universal Waste Labels	6" x 6" Vinyl	100
60362	Universal Waste Labels	6" x 6" Paper	100

## Asbestos Labels

- Made of self-adhesive vinyl
- Standard package: 100 labels



Catalog #	Description	Size	Qty.
121061	Asbestos Labels	4" x 4" Vinyl	100
121438	Asbestos Labels	6" x 6" Vinyl	100

## Waste Disposal Labels

- Use to easily identify and sort waste

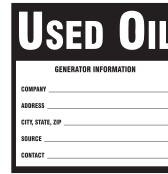

Catalog #	Description	Qty.
121432	6" x 6" Vinyl	100
60367	6" x 6" Paper	100

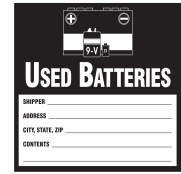

Catalog #	Description	Qty.
121431	6" x 6" Vinyl	100
60365	6" x 6" Paper	100

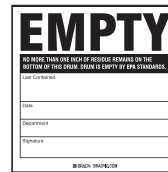

Catalog #	Description	Qty.
121439	6" x 6" Vinyl	100
60363	6" x 6" Paper	100



Catalog #	Description	Qty.
63240	6" x 6" Vinyl	500



Catalog #	Description	Qty.
121436	6" x 6" Vinyl	100
60364	6" x 6" Paper	100

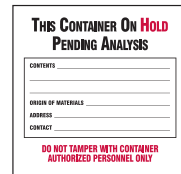

Catalog #	Description	Qty.
121140	6" x 6" Vinyl	100
60366	6" x 6" Paper	100

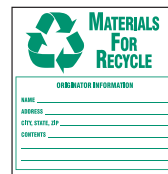

Catalog #	Description	Qty.
121062	6" x 6" Vinyl	100
60369	6" x 6" Paper	100



Catalog #	Description	Qty.
121440	6" x 6" Vinyl	100



Catalog #	Description	Qty.
121434	6" x 6" Vinyl	100



Catalog #	Description	Qty.
121435	6" x 6" Vinyl	100



Catalog #	Description	Qty.
121433	6" x 6" Vinyl	100



# Hazardous Material Shipping

BradyID.com/s34

## Hazardous Material Shipping Labels

- Composite plastic material offers extreme weatherability so label colors stay bright
- Super tacky adhesive back permanently bonds to most surfaces (including low energy surfaces such as polyethylene bags).
- Labels withstand temperatures of -50°



### Class 2:



121066 4"x4" B-7569 500/roll



121468 4"x4" B-7569 500/roll



121065 4"x4" B-7569 500/roll



121469 4"x4" B-7569 500/roll

### Class 3:



121067 4"x4" B-7569 500/roll

### Class 4:



121069 4"x4" B-7569 500/roll



121470 4"x4" B-7569 500/roll



121068 4"x4" B-7569 500/roll

### Class 5:



121071 4"x4" B-7569 500/roll



121471 4"x4" B-7569 500/roll

### Class 6:



121466 4"x4" B-7569 500/roll



63473 4"x4" B-7569 500/roll



121472 4"x4" B-7569 500/roll



121467 4"x4" B-7569 500/roll

### Class 7:



121473 4"x4" B-7569 500/roll



121441 4"x4" B-7569 500/roll

### Class 8:



121070 4"x4" B-7569 500/roll

### Class 9:



121141 4"x4" B-7569 500/roll



### Also Available: Vehicle Placard Signs

Brady also offers a wide range of Vehicle Placard Signs for shipping hazardous materials.

View signs on page 79.





## GHS SDS Centers

- 20"H x 14"W x 4.5"D center offered in English and English/Spanish
- Includes 1.5" SDS binder, "Right To Know Compliance Center" backboard, and yellow wire rack

Catalog #	Description
121370	SDS Center – English
121371	SDS Center – English/Spanish



## Right To Know Compliance Center

- 20"H x 14"W x 4-1/2"D compliance center includes red polystyrene board, binder rack and MSDS binder (2023)
- 1.5" MSDS binder w/ 300 sheet capacity

Catalog #	Description
2010	Compliance Center
RK018A	Compliance Center w/inserts
2010NB	Compliance Center w/o binder
2010SP*	Spanish Compliance Center

\*Board is Spanish with Bilingual Binder (2026)



## Job Site Center

- Includes Job Site binder with fold away handles
- Binder has 2 sets of 1" nylon rings that will hold approximately 400 pgs
- PVC coated wire rack can be mounted anywhere you need it
- Center size: 12-1/2"H x 14"W x 4-3/4"D

Catalog #	Description
2032	Job Site Center
2022	Job Site Binder Only

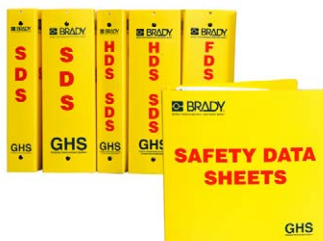

## GHS SDS Binders

- Complies with OSHA regulations
- 1.5" dia. ring holds 275-300 sheets  
3" dia. ring holds 600 sheets
- Durable polyethylene cover, a 36" chain and a pair of sheet lifters

Catalog #	Description
121183	1.5" SDS Binder, English
121184	3" SDS Binder, English
121185	1.5" SDS Binder, English/Spanish
121186	3" SDS Binder, English/Spanish
121187	3" SDS Binder, English/French



## Double Right To Know Compliance Center

- This center includes red polystyrene board, 2 binder racks and two MSDS binders
- Center size: 20"H x 29"W x 4-1/2"D

Catalog #	Description
2010DB	Double RTK Compliance Center
2010DBSP	Spanish Double RTK Center*

\*Board is Spanish with Bilingual Binder (2026)



## Information Centers

- Rugged poly backboard comes with white PVC coated wire basket, allowing for high visibility and convenience for holding important papers
- Tear resistant 3-ring binder holds approx. 300 sheets and includes chain and mounting hardware
- Center Size: 20"H x 14"W

Catalog #	Description
IC326E	Emergency Information Center

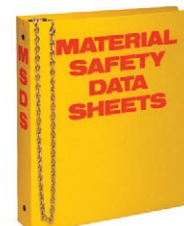

## Standard MSDS Binders

- 1-1/2" dia. rings hold 275-300 sheets  
2-1/2" dia. ring holds 400-500 sheets  
3" dia. ring holds 600 sheets
- Durable polyethylene cover, 36" chain and pair of sheet lifters

Catalog #	Description
2023	1.5" MSDS Binder
2024	2.5" MSDS Binder
2025	3.0" MSDS Binder
2026	1.5" Bilingual MSDS Binder
2027	2.5" Bilingual MSDS Binder
2028	3.0" Bilingual MSDS Binder

\*Insert is catalog #BR801B



## Economy Right To Know Center

- Includes MSDS "V" sign, 8"H x 14-1/2"W x 6"D
- 1.5" MSDS binder with 300 sheet capacity

Catalog #	Description
2007	Economy RTK Center
RK085A	Rack & Binder w/inserts
2005	Rack & Binder Only



## Standard Operating Procedures Center

- Poly backboard w/ white PVC coated wire basket
- Rugged binder holds approximately 300 sheets and comes with an attached chain
- Binders are available separately

Catalog #	Description
SM681A	Procedures Center
SM682A	Double Standard Operation Procedures Center



# Safety Information Centers

BradyID.com/s34



## MSDS Metal Cabinet

- Wall mountable cabinet made of 20 gauge powder coated steel
- Front panel pulls down to reveal a guide to Haz-Mat labels
- Equipped center includes:
  - 2 - 2-1/2" MSDS Binders (2024)
  - 25 - Right To Know training booklets (2101)
  - 1 - Binder training insert (BR801B)
- Cabinet size: 22-1/2"H x 26-1/2"W x 6"D

Catalog #	Description
RK623E	MSDS Metal Cabinet



## Bloodborne Pathogen Compliance Center

- Wall mount display includes a 1-1/2" binder that holds up to 300 pages of your exposure control plans (not included)
- Center size: 20"H x 14"W x 4-1/2"D

Catalog #	Description
BH2010	Bloodborne Pathogen Center
BH2023	Exposure Control Binder only



## Binder Holders

- PVC coated steel racks designed for holding binders up to 3" ring diameter
- Single: 9"H x 14"W x 4.5"D
- Double: 9"H x 14"W x 6.5"D

Catalog #	Description	Color	Qty.
2014	Single Binder Holder	Yellow	1
2014W	Single Binder Holder	White	1
104791	Double Binder Holder	Yellow	1
104792	Double Binder Holder	White	1



## MSDS Training Binder Insert

- This detailed binder insert package contains:
  - OSHA Haz-Com Standard highlights and overview of program requirements
  - Compliance checklist
  - Two 15 page RTK training booklets,
  - Mini RTK poster (Spanish/English)
  - 50 clear sheet protectors
  - A-Z index tabs
  - Binders sold separately

Catalog #	Description
BR801B	Binder Insert



## Lockout Procedure Station

- Durable polystyrene board includes pre-drilled holes and mounting hardware
- Backboard dimensions: 20"H x 14"W x 4.5"D

Catalog #	Description
LOSP22	Station With Binder & 25 Forms
99289	Lockout Procedure Station With Binder Only
LOSB1	Lockout Procedure Binder Only



## Suggestion Box

- Wall or table mount black acrylic box w/ a lockable top & side pocket
- Box: 12"H x 11-3/4"W x 4-3/4"D
- Pocket: 5"H x 4"W x 13/8"D
- Top drop slot: 9" W

Catalog #	Description
MC111E	Suggestion Box



## Standard Right To Know Center

- Acrylic board can hold up to 100 booklets and a MSDS binder
- Includes our 1-1/2" binder and 10 training booklets
- Center size: 30"H x 24"W x 4-1/2"D

Catalog #	Description
2001	Standard Right to Know Center
2012	Board Only
2002	Bilingual version*

\*includes 5 English booklets, 5 Spanish booklets and a bilingual binder



## MSDS/Job Site Safety Document Center

- Table top or wall mount center holds one 3-ring binder in a weather resistant and lockable polystyrene case
- Size: 13-1/2"H x 13-1/2"W x 4-3/4"D

Catalog #	Description
JS1	MSDS/Job Site Center

**There's more online!**

Visit [BradyID.com](http://BradyID.com) to view more Safety & Regulatory products to keep you're employees safe and to stay in compliance.

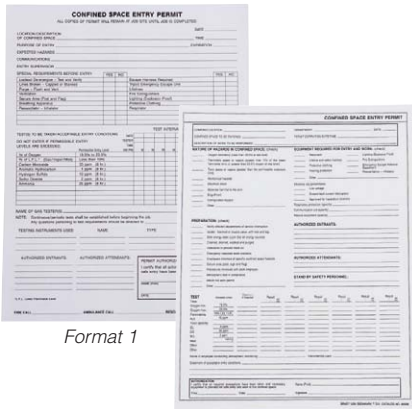

Format 1

Format 2

## Confined Space Entry Permits

- 8-1/2" x 11" forms include all information required by OSHA's Confined Space Regulation
- Available in several materials to best meet your facility's environment

Catalog #	Description	Format	Qty
EP1	Permit Holder	1	25/pk
65938	Tyvek (water/chemical resistant)	2	25/pk
65937	2-ply Carbonless	2	25/pk



## Confined Space Permit Center

- Wall mounted Permit Center provides ready access to entry permits while making employees aware of special safety requirements
- Holds 8-1/2" x 11" forms  
Holder dimensions: 15.75" x 23.5"
- Permits/forms sold separately

Catalog #	Description	Qty
PC1	Permit Center (Permit forms sold separately)	25/pk



## Confined Space Entry Permits & Holder

- Provides a confined space warning and easy access to permits
- Made of durable polycarbonate material
- Holds 8-1/2" x 11" forms  
Holder dimensions: 12" x 19"
- Permits/forms sold separately

Catalog #	Description	Qty
65903	Permit Holder (Permit Forms sold separately)	1



## Safe-T-Grip® Fuse Pullers

- Provides maximum convenience when removing or replacing cartridge fuses
- Notched handles for no-slip grip
- Clearly marked amperage ranges
- Exceeds MIL specifications

Catalog #	Description
65280	(C) For 0-100A, 250V & 600V: 7-1/2" long



## E-Z Check® Plus GFI Circuit Tester

- Checks for the following conditions: correct wiring, open ground, reverse polarity, open hot, open neutral, hot on neutral, hot and ground reversed with open hot, and ground fault interruption

Catalog #	Description
65273	E-Z Check® Plus GFI Circuit Tester



## Battery Cleaning & Charging Safety Kit

- Help minimize the risk of employee acid burns or shocks while charging batteries
- Fully equipped portable kit includes:
  - (1) pair of large unsupported neoprene over natural rubber gloves
  - (1) pair of clear chemical goggles with indirect ventilation
  - (1) 45" x 35" black rubber apron
  - (1) 8" synthetic brush
  - (2) 9-1/4" x 14-1/2" chemical sorbent pads for small spills
  - (1) quart neutralizing and cleaning agent with trigger sprayer
  - (1) laminated instruction card

Catalog #	Description
BCK	Battery cleaning & charging kit



# Numbers & Letters

BradyID.com/s34



## ToughStripe® Floor Marking Numbers & Letters

- Easy to view 6"W x 8"H numbers and letters come in packs of 20
- Ideal for marking aisle-ways, shipping and receiving docks, distribution centers, or other areas of your facility

	Black 20/pk	White 20/pk	Red 20/pk	Green 20/pk	Blue 20/pk	Yellow 20/pk
A	121691	121692	121693	121694	121695	121696
B	121697	121698	121699	121700	121701	121702
C	121703	121704	121705	121706	121707	121708
D	121709	121710	121711	121712	121713	121714
E	121715	121716	121717	121718	121719	121720
F	121721	121722	121723	121724	121725	121726
G	121727	121728	121729	121730	121731	121732
H	121733	121734	121735	121736	121737	121738
I	121739	121740	121741	121742	121743	121744
J	121745	121746	121747	121748	121749	121750
K	121751	121752	121753	121754	121755	121756
L	121757	121758	121759	121760	121761	121762
M	121763	121764	121765	121766	121767	121768
N	121769	121770	121771	121772	121773	121774
O	121775	121776	121777	121778	121779	121780
P	121781	121782	121783	121784	121785	121786
Q	121787	121788	121789	121790	121791	121792
R	121793	121794	121795	121796	121797	121798
S	121799	121800	121801	121802	121803	121804
T	121805	121806	121807	121808	121809	121810
U	121811	121812	121813	121814	121815	121816

	Black 20/pk	White 20/pk	Red 20/pk	Green 20/pk	Blue 20/pk	Yellow 20/pk
V	121817	121818	121819	121820	121821	121822
W	121823	121824	121825	121826	121827	121828
X	121829	121830	121831	121832	121833	121834
Y	121835	121836	121837	121838	121839	121840
Z	121841	121842	121843	121844	121845	121846
0	121847	121848	121849	121850	121851	121852
1	121853	121854	121855	121856	121857	121858
2	121859	121860	121861	121862	121863	121864
3	121865	121866	121867	121868	121869	121870
4	121871	121872	121873	121874	121875	121876
5	121877	121878	121879	121880	121881	121882
6	121883	121884	121885	121886	121887	121888
7	121889	121890	121891	121892	121893	121894
8	121895	121896	121897	121898	121899	121900
9	121901	121902	121903	121904	121905	121906
Punct. Set*	121907	121908	121909	121910	121911	121912

\* 20 Punctuation Sets per package. Each set includes: two periods, one comma, one exclamation point, one question mark, one forward slash, one dash, and one ampersand (&).



## 34 Series Indoor Numbers & Letters

- B-498 plastic coated cloth numbers & letters with pressure sensitive adhesive
- Permanent or Repositionable: once applied, numbers & letters are there to stay...unless you want to change them
- Black characters on a yellow background

Catalog #	Character Height	Marker Size	Markers Per Card
<b>Available in numbers (0-9), letters (A-Z), dashes (DSH)</b>			
3400-*	1/4"	3/8" x 1/4"	144
3410-*	3/8"	1/2" x 1/32"	78
<b>Available in numbers (0-9), letters (A-Z), dashes (DSH) and arrows (ARO)</b>			
3420-*	5/8"	3/4" x 9/16"	32
3430-*	1"	1-1/2" x 7/8"	10
3440-*	1-15/16"	2-1/4" x 7/8"	10
3450-*	2-15/16"	3-1/2" x 1-1/2"	6
<b>Available in numbers (0-9), letters (A-Z), dashes (DSH) and blanks (BLANK)</b>			
3460-*	3-7/8"	5" x 1-3/4"	5
3470-*	6"	9" x 5"	1

To order: replace the asterisk (\*) with the desired characters listed above.



## 34 Series Combination Packs

- B-498 plastic coated cloth tape with pressure sensitive adhesive
- Number packs contain all numbers from 0-9; number of cards vary according to their frequency of use
- Standard package: 25 assorted cards

Catalog #	Character Height	Marker Size	Markers Per Card
<b>Letter Combinations Packs</b>			
3400-LTR KIT	1/4"	3/8" x 1/4"	144
3410-LTR KIT	3/8"	1/2" x 1/32"	78
3420-LTR KIT	5/8"	3/4" x 9/16"	32
3430-LTR KIT	1"	1-1/2" x 7/8"	10
3440-LTR KIT	1-15/16"	2-1/4" x 7/8"	10
3450-LTR KIT	2-15/16"	3-1/2" x 1-1/2"	6
3460-LTR KIT	3-7/8"	5" x 1-3/4"	5
3470-LTR KIT	6"	9" x 5"	1
<b>Number Combinations Packs</b>			
3400-# KIT	1/4"	3/8" x 1/4"	144
3410-# KIT	3/8"	1/2" x 1/32"	78
3420-# KIT	5/8"	3/4" x 9/16"	32
3430-# KIT	1"	1-1/2" x 7/8"	10
3440-# KIT	1-15/16"	2-1/4" x 7/8"	10
3450-# KIT	2-15/16"	3-1/2" x 1-1/2"	6
3460-# KIT	3-7/8"	5" x 1-3/4"	5
3470-# KIT	6"	9" x 5"	1



## 34 Series Consecutive Markers

- B-498 plastic coated cloth numbers & letters with pressure sensitive adhesive
- Contains numerical or alphabetical sequences on same card
- Larger sized cards break the alphabet into three parts: A-j, K-T and U-Z

Catalog #	Legend	Char. Height	Marker Size	Markers Per Card
34010	(0-9)	1/4"	3/8" x 1/4"	144
34110	(0-9)	3/8"	1/2" x 1/32"	78
34138	(A-Z)	3/8"	1/2" x 1/32"	78
34210	(0-9)	5/8"	3/4" x 9/16"	32
34238	(A-Z)	5/8"	3/4" x 9/16"	32
34310	(0-9)	1"	1-1/2" x 7/8"	10
34340	(A-J)	1"	1-1/2" x 7/8"	10
34341	(K-T)	1"	1-1/2" x 7/8"	10
34342	(U-Z)	1"	1-1/2" x 7/8"	10
34410	(0-9)	1-15/16"	2-1/4" x 7/8"	10
34440	(A-J)	1-15/16"	2-1/4" x 7/8"	10
34441	(K-T)	1-15/16"	2-1/4" x 7/8"	10
34442	(U-Z)	1-15/16"	2-1/4" x 7/8"	10



## Magnetic Numbers

- Number height is 1-1/2"
- Perfect for safety scoreboards
- Standard package:  
15 each of 0-3  
8 each of 4-9

Catalog #	Size	Qty.
57624	1-1/2"	108



## 15 Series Numbers & Letters (B-946)

- B-946 premium outdoor grade vinyl with permanent pressure sensitive adhesive
- Designed for permanent applications in severe outdoor environments as well as indoors. Special acrylic adhesive adheres strongly, making marker removal difficult

Catalog #	Character Height	Marker Size	Markers Per Card
<b>Available in letters (A-Z), dashes (DSH) only</b>			
1500-*	1/4"	3/8" x 1/4"	144
<b>Available in numbers (0-9), letters (A-Z), dashes (DSH) and arrows (ARO).</b>			
1520-*	5/8"	3/4" x 9/16"	32
1530-*	1"	1-1/2" x 7/8"	10
1534-*	1-15/16"	2-1/4" x 7/8"	10
1550-*	2-15/16"	3-1/2" x 1-1/2"	6
<b>Available in numbers (0-9), letters (A-Z), dashes (DSH)</b>			
1560-*	3-7/8"	5" x 1-3/4"	5
1570-*	6"	9" x 5"	1

To order: replace the asterisk (\*) with the desired character.



## 15 Series Outdoor Numbers & Letters Combo Packs

- B-946 premium outdoor grade vinyl with permanent pressure sensitive adhesive
- Black characters on a yellow bkgnd
- Standard package: 25 assorted cards

Catalog #	Character Height	Marker Size	Markers Per Card
<b>Letter Combinations Packs</b>			
1500-LTR KIT	1/4"	3/8" x 1/4"	144
1520-LTR KIT	5/8"	3/4" x 9/16"	32
1530-LTR KIT	1"	1-1/2" x 7/8"	10
1534-LTR KIT	1-15/16"	2-1/4" x 7/8"	10
1550-LTR KIT	2-15/16"	3-1/2" x 1-1/2"	6
1560-LTR KIT	3-7/8"	5" x 1-3/4"	5
1570-LTR KIT	6"	9" x 5"	1
<b>Number Combinations Packs</b>			
1500-# KIT	1/4"	3/8" x 1/4"	144
1520-# KIT	5/8"	3/4" x 9/16"	32
1530-# KIT	1"	1-1/2" x 7/8"	10
1534-# KIT	1-15/16"	2-1/4" x 7/8"	10
1550-# KIT	2-15/16"	3-1/2" x 1-1/2"	6
1560-# KIT	3-7/8"	5" x 1-3/4"	5
1570-# KIT	6"	9" x 5"	1



## Seriesystem™ Kit Serialized Markers

- B-507 plastic coated cloth tape with black character on a yellow background
- 10 single digit cards (0-9) included in each kit for replacing numbers

Catalog #	Legends	Char. Height	Marker Size	Markers Per Card
34353	01-99	1"	1-1/2" x 1-1/2"	6
34253	001-999	5/8"	3/4" x 1-1/2"	12



## 97 Series Indoor/Outdoor Numbers & Letters

- B-946 with superior abrasion and chemical resistance - resists oil, grease, water and mild solvents
- UV resistance
- Designed for permanent applications in outdoor environments as well as indoors.
- Superior abrasion resistance
- Stock cards: numbers 0-9; capital letters A-Z; dash

Catalog #	Card Size	Character Height	Markers Per Card
9712-*	3/4" x 2-1/32"	5/8"	20
9713-*	1-1/2" x 1-1/16"	1"	10
9714-*	2-1/4" x 1-13/16"	1-15/16"	5

To order: replace the asterisk (\*) with the desired number (0-9), capital letter (A-Z) or dash (DSH).



## 97 Series Indoor/Outdoor Numbers & Letters

- B-946 with superior abrasion and chemical resistance - resists oil, grease, water and mild solvents
- UV resistance
- Designed for permanent applications in outdoor environments as well as indoors.
- Standard package: 25 assorted cards

Catalog #	Character Height	Marker Size	Markers Per Card
<b>Letter Combinations Packs</b>			
9712-LTR KIT	5/8"	3/4" x 21/32"	20
9713-LTR KIT	1"	1-1/2" x 13/16"	10
9714-LTR KIT	1-15/16"	2-1/4" x 1-13/16"	5
<b>Number Combinations Packs</b>			
9712-# KIT	5/8"	3/4" x 21/32"	20
9713-# KIT	1"	1-1/2" x 13/16"	10
9714-# KIT	1-15/16"	2-1/4" x 1-13/16"	5



# Numbers & Letters

BradyID.com/s34



## Aluminum Utility Panels

- Twenty mil. (.020") aluminum panels are designed to be rugged, yet flexible to conform to pole curve
- Recommended use with B-946 vinyl or B-997 reflective sheeting markers
- 7-1/4" panel holds up to eight vinyl or reflective markers
- 12" panel holds up to eleven reflective markers or twelve vinyl markers

Catalog #	Panel Size	Marking Size	Qty.
97198	1-3/4" x 7-1/4"	1-3/4" x 6-1/2"	25
97199	1-3/4" x 12"	1-3/4" x 11-1/4"	25



## Reflective Quik-Lite® Ten Packs

- B-957 reflective material with permanent, aggressive adhesive for indoors or outdoors
- Standard package:
  - 10 identical characters or arrows;
  - 5 identical \$ or &; Punctuation includes 5 periods and 5 commas

Size	Uppercase	Lowercase (a-z)
1"	9720-*	9703-*
1-1/2"	9730-*	9704-*
2"	9740-*	9705-*
3"	9750-*	9706-*
4"	9760-*	9707-*
6"	9770-*	9708-*

Letter sizes refer to uppercase letters, lowercase are proportional.

To order: replace the asterisk (\*) with the desired number (0-9), capital letter (A-Z), arrow (ARO), (&), (\$) or punctuation (PUNC)



## Outdoor Numbers & Letters (B-946)

- B-946 tough vinyl film provides high visibility and lasting performance
- UV resistant protects against fading and shrugs off oil and water
- Meets APWA color code: black on orange for communications yellow on black for electric, oil and gas
- Standard package: 1 card

Catalog #	Char. Height	Marker Size	Color	Markers Per Card
6560-*	1"	1-1/2" x 7/8"	Blk on Org	10
6570-*	1-15/16"	2-1/4" x 7/8"	Blk on Org	10
7890-*	1"	1-1/2" x 7/8"	Ylw on Blk	10
7897-*	1-15/16"	2-1/4" x 7/8"	Ylw on Blk	10

To order: replace the asterisk (\*) with the desired number (0-9), capital letter (A-Z) or dash (DSH).



## Reflective Quik-Lite® Kits

- B-957 reflective material with permanent, aggressive adhesive firmly grips to most clean, dry surfaces indoors or outdoors
- Uppercase kit contain:
  - 20 each of A, E, I, L, N, O, R, S, T, 0-9
  - 10 each of arrows and remaining letters
  - 5 each of \$, & and punctuation
- Lowercase kit contain:
  - 20 each of A, E, I, L, N, O, R, S, T
  - 10 each of remaining letters

Size	Uppercase	Lowercase
4"	97554	97555
6"	97556	97557

Letter sizes refer to uppercase letters, lowercase are proportional.



## BradyLite® Reflective Numbers & Letters (B-997)

- Reflects light 100 times brighter than a plain white surface
- Will perform despite storms, snow, humidity and other tough environmental conditions
- Can be applied in temps as low as 10°F
- Standard package: 25 cards

Catalog #	Char. Height	Marker Size	Color	Markers Per Card
5900-*	1"	1-1/2" x 1"	Blk on Slvr	1
5905-*	1"	1-1/2" x 1"	Ylw on Blk	1
5920-*	1"	1-1/2" x 1"	Blk on Ylw	1
5890-*	1-1/2"	1-7/8" x 1-3/8"	Ylw on Blk	1
5000-*	2-1/2"	2-7/8" x 1-3/4"	Ylw on Blk	1

Only available in numbers (0-9) and blank (BLANK)

5910-*	1"	1-1/2" x 1"	Blk on Org	1
--------	----	-------------	------------	---

To order: replace the asterisk (\*) with the desired number (0-9), capital letter (A-Z), dash (DSH) or blank (BLANK)



## Preprinted KVA Markers

- Help determine the KVA classification of pole-mounted transformers
- Yellow numbers printed on B-997 BradyLite® Reflective Sheeting
- Markers come with slit liner for easy application
- Standard Package: 25 cards

Catalog #	Legend	Marker Size	Markers Per Card
50010	712	2-7/8" x 3-1/4"	1
50011	10	2-7/8" x 3-1/4"	1
50012	15	2-7/8" x 3-1/4"	1
50013	25	2-7/8" x 3-1/4"	1
50015	50	2-7/8" x 3-1/4"	1
50016	75	2-7/8" x 3-1/4"	1
50014	3712	2-7/8" x 3-1/4"	1
50017	100	2-7/8" x 3-1/4"	1
50018	150	2-7/8" x 3-1/4"	1
50019	167	2-7/8" x 3-1/4"	1
50020	500	2-7/8" x 3-1/4"	1



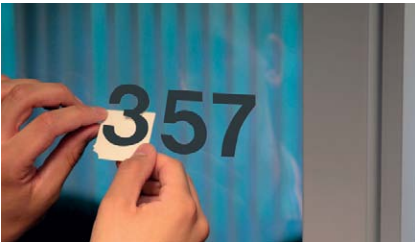

## Helvetica Quik-Align® Ten Packs

- B-933 black vinyl film with permanent adhesive
- Standard package:
  - 10 identical characters or arrows;
  - 5 identical \$ or &; Punctuation includes 5 periods and 5 commas

Size	Uppercase	Lowercase
1"	-	8235-*
1-1/2"	-	8240-*
2"	8210-*	8245-*
3"	8215-*	8250-*
4"	-	8255-*
Available in numbers (0-9), (&), (\$) only		
1"	8200-*	
1-1/2"	8205-*	
4"	8220-*	

Letter sizes refer to uppercase letters, lowercase are proportional.  
 To order: replace the asterisk (\*) with the desired number (0-9), capital letter (A-Z), (&), (\$) or punctuation (PUN).



## Aluminum Embossed Numbers & Letters

- Roman style numbers and letters contain pre-punched holes for easy installation; 1" nails included

Catalog #	Character Height	Qty.
1600-*	3"	10

To order: replace the asterisk (\*) with the desired number (0-9), capital letter (A-Z).



## Gothic Quick-Align® Ten Packs

- B-7569 vinyl with permanent adhesive
- Order in 10 packs only, no broken packages
- Standard package:
  - 10 identical characters or arrows;
  - 5 identical \$ or &; Punctuation includes 5 periods and 5 commas
- Ideal to refill your Quick-Align Kit

Size	Black	Yellow	Red	White
1"	5010-*	-	-	5040-*
2"	5050-*	5060-*	-	5080-*
3"	5100-*	5110-*	5120-*	5130-*
4"	5140-*	5150-*	5160-*	5170-*
6"	5180-*	-	-	5210-*
Condensed Numbers & Letters (arrows not available)				
2"	6450-*	-	-	-
3"	6500-*	-	-	-

To order: replace the asterisk (\*) with the desired number (0-9), capital letter (A-Z), arrow (ARO), (\$), (&) or punctuation (PUN).



## 3-Series Glow-in-the-Dark/ Ultra Reflective Numbers & Letters

- 7x more reflective than other reflective materials
- Black characters w/ glow-in-the-dark border on a highly reflective silver background
- Designed for permanent application in severe outdoor environments as well as indoors.

Catalog #	Marker Size	Character Size	Qty
3000-*	2-7/8" x 1-1/2"	2"	10
3010-*	3-1/2" x 2-1/2"	3"	10
3020-*	6" x 3"	5"	10

To order: replace the asterisk (\*) with the desired number (0-9), capital letter (A-Z), dash (DSH), blank (BLANK), ampersand (&) or period (PRD).



## Gothic Quick-Align® Kits

- B-7569 vinyl with permanent adhesive
- Self-spacing, self-aligning diecuts
- Industrial grade vinyl
- Each kit contains:
  - 20 each of A, E, I, L, N, O, R, S, T, and 0-9;
  - 10 each of remaining letters;
  - 5 each of \$, & and punctuation

Size	Black	Yellow	Red	White
1"	52203	-	-	52204
2"	52207	52210	-	52208
3"	52211	52214	-	52212
4"	52215	-	52213	52216
6"	52219	-	52217	52220
Condensed Numbers & Letters Kits				
1"	52180	-	-	-
2"	52184	-	-	-
3"	52188	-	-	-



## BradyGlo™ Gothic Quik-Align Numbers and Letters

- BradyGlo™ photoluminescent material on blue peel off liner charges in 5 minutes at 1000 Lux for 10+ hours of glow time
- Consistent glow life and unlimited rechargability
- Complies with ASTM 2030-99: Recommended Uses of Photoluminescent Safety Markings

Catalog #	Character Size	Qty
6001-*	1"	25
6002-*	2"	25
6003-*	3"	25
6004-*	4"	25

To order: replace the asterisk (\*) with the desired number (0-9) or capital letter (A-Z).



# Arc Flash Labels

BradyID.com/arcflash

## NFPA70 National Electric Code

### 110.16 Flash Protection

Switchboards, panelboards, industrial control panels, meter socket enclosures, and motor control centers that are in other than dwelling occupancies and are likely to require examination, adjustment, servicing, or maintenance while energized shall be field marked to warn qualified persons of potential electric arc flash hazards. The marking shall be located so as to be clearly visible to qualified persons before examination, adjustment, servicing, or maintenance of the equipment.

**FPN No. 1:** NFPA 70E-2012, Standard for Electrical Safety in the Workplace, provides assistance in determining severity of potential exposure, planning safe work practices, and selecting personal protective equipment.

**FPN No. 2:** ANSI Z535.4-1998, Product Safety Signs and Labels, provides guidelines for the design of safety signs and labels for application to products.

### Arc Flash Labels with Pre-printed Hazard Categories

- Labels come with the hazard category and PPE requirements preprinted
- Write-in areas for specifics such as minimum arc rating, flash protection boundary, etc.
- B-7569 vinyl can be written on with pen or marker
- Updated for the NFPA 70E 2012 edition

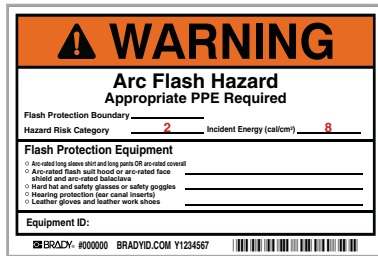

4" x 6" Arc flash hazard

Catalog #	Header	Hazard	Size	Quantity
121095	Warning	0	4" x 6"	5/pack
121097	Warning	1	4" x 6"	5/pack
121099	Warning	2	4" x 6"	5/pack
121101	Warning	3	4" x 6"	5/pack
121103	Warning	4	4" x 6"	5/pack
121096	Danger	0	4" x 6"	5/pack
121098	Danger	1	4" x 6"	5/pack
121100	Danger	2	4" x 6"	5/pack
121102	Danger	3	4" x 6"	5/pack
121104	Danger	4	4" x 6"	5/pack



5" x 7" Arc flash & shock hazard

Catalog #	Header	Hazard	Size	Quantity
121083	Warning	0	5" x 7"	5/pack
121085	Warning	1	5" x 7"	5/pack
121087	Warning	2	5" x 7"	5/pack
121091	Warning	3	5" x 7"	5/pack
121093	Warning	4	5" x 7"	5/pack
121084	Danger	0	5" x 7"	5/pack
121086	Danger	1	5" x 7"	5/pack
121088	Danger	2	5" x 7"	5/pack
121092	Danger	3	5" x 7"	5/pack
121094	Danger	4	5" x 7"	5/pack

### Write-On Arc Flash Labels

- Write-in areas for equipment-specific information like flash protection boundary, hazard category, and required PPE.
- B-7569 vinyl can be written on with pen or marker
- Updated for the NFPA 70E 2012 edition

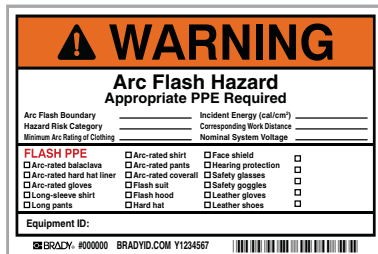

4" x 6" Arc flash hazard

Catalog #	Header	Size	Quantity
121079	Warning	4" x 6"	5/pack
121080	Danger	4" x 6"	5/pack

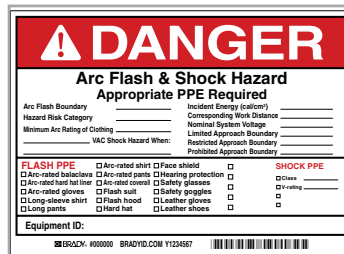

5" x 7" Arc flash & shock hazard

Catalog #	Header	Size	Quantity
121077	Warning	5" x 7"	5/pack
121078	Danger	5" x 7"	5/pack

**Print Your Own Arc Flash Labels**

The BBP®31 Sign & Label Printer can take on all your arc flash labeling needs! View page 352 for more information.

Promote awareness of the dangers associated with arc flash accidents and make sure your workers know how to protect themselves!

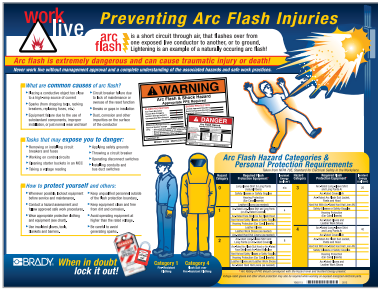

Poster

## Poster

- Highlights the common causes of arc flash and provides safe work practices and personal protection equipment requirements
- Laminated on both sides to stand up to industrial environments
- Full-color printing and eye-catching graphics for optimum visual impact
- Poster reflects all changes from NFPA 70E-2012 regulation

Catalog #	Description	Quantity
104571	18" x 24" Poster	1 each

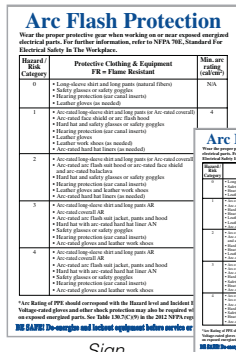

Sign

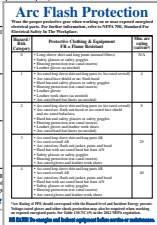

Label

## Sign & Label

- Post signs and labels in the work area and near electrical equipment to boost awareness and compliance
- Signs and labels specify the personal protection equipment required for each arc flash hazard category
- Sign and label reflects all changes from NFPA 70E-2012 regulation
- Sign: BradyTuff™ B-401 rigid plastic, laminated graphics  
Label: Self-sticking B-302 polyester with overlamine

Catalog #	Description	Quantity
102523	7" x 10" Sign	1 each
102524	3.5" x 5" Label	5/pack

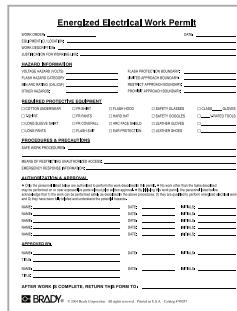

Work Permit

## Work Permit

- Meets NFPA 70E 130.1(A) requirements which mandate the use of a written permit when performing live electrical work
- 2-ply carbonless copy paper

Catalog #	Description	Quantity
99287	8.5" x 11" Permit	25/pack

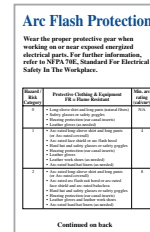

Wallet Card Front

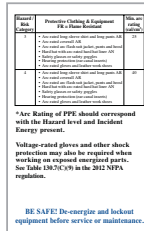

Wallet Card Back

## Wallet Card

- Ensure compliance and safety by providing each employee with their own arc flash wallet card
- Card specifies the personal protection equipment required for each arc flash hazard category
- Made of laminated cardstock, two-sided printing
- Reflects all changes from NFPA 70E-2012 regulation

Catalog #	Description	Quantity
102525	2.1" x 3.4" Card	25/pack



## Learn more with our Arc Flash Whitepaper

Download the Arc Flash Labeling Whitepaper to learn more details about compliance regulations, labeling standards, best practices and more.

Visit [BradyID.com/arcflash](http://BradyID.com/arcflash) to download.



BradyID.com/s34

## Conduit and Voltage Labels

- Orange markers meet ASME (ANSI) Standard ZG3.22 and alert employees to potentially dangerous machinery or energized equipment
- Cards sold individually

### 120 VOLTS

Style A:

(1) 2-1/4" x 9" Marker Per Card

### 120 VOLTS 120 VOLTS

Style B:

(4) 1-1/8" x 4-1/8" Markers Per Card

### 120 VOLTS 120 VOLTS

Style C:

(18) 1/2" x 2-1/4" Markers Per Card

Legend	Style A	Style B	Style C
(blank)	44099	44100	-
110 Volts	44101	44201	44301
115 Volts	44102	44202	44302
120 Volts	44104	44204	44304
120/208 Volts	44159	44259	44359
208 Volts	44106	44206	44306
220 Volts	44107	44207	44307
230 Volts	44108	44208	44308
240 Volts	44110	44210	44310
250 Volts	44111	44211	44311
277 Volts	44112	44212	-
277/480 Volts	44160	44260	44360
440 Volts	44113	44213	44313
460 Volts	44114	44214	44314
480 Volts	44115	44215	44315
550 Volts	44116	44216	-
600 Volts	44118	44218	-
2300 Volts	44134	44234	-
2400 Volts	44121	44221	-
4160 Volts	44122	44222	-

Legend	Style A	Style B	Style C
4800 Volts	44124	-	-
6900 Volts	44125	-	-
7200 Volts	44126	-	-
13,200 Volts	44151	-	-
AC	44127	44227	44327
Air Conditioning	44247	-	44347
Circuit #	44155	44255	-
Circuit Breaker	44157	44257	-
DC	44138	44238	44338
Electric Out of Service	-	44250	-
Emergency Service	-	-	44328
Fuse Box	44158	44258	-
Heating Circuit	-	44248	-
Light & Power	-	44242	44342
Lights	44133	44233	44333
On/Off	-	44256	-
Power	44132	44232	44332
Single Phase	44129	44229	44329
Three Phase	44131	44231	44331
Volts	44149	-	-

## Mr. Ouch Transformer Labels

- National Electrical Manufacturers Association (NEMA) recommends use on transformers located in public areas
- Meet the NEMA Standard as well as Underwriters Laboratory Performance Standard #969
- Made of B-927 tamper-resistant film



46346 8" x 4.5" B-927 1 ea.



46347 8" x 4.5" B-927 1 ea.



46348 4.5" x 10.75" B-927 1 ea.



46349 4.5" x 10.75" B-927 1 ea.

## Warning Labels

- Call attention to hazards on paperwork, equipment and packages
- Made of B-946 pressure sensitive vinyl
- 1/2", 1" and 2" labels: 10 labels per card
- 4" labels: 3 labels per card
- 8" labels: 1 label per card
- Standard package: 10 cards



No Smoking

60237 2" x 2" B-946 50/pk

\* 5 labels per card. 10 cards per package



Acid

60184 1/2" x 1/2" B-946 100/pk  
60195 1" x 1" B-946 100/pk  
60206 2" x 2" B-946 100/pk  
60217 4" x 4" B-946 30/pk  
60228 8" x 8" B-946 10/pk



Battery Hazard

60186 1/2" x 1/2" B-946 100/pk  
60197 1" x 1" B-946 100/pk  
60208 2" x 2" B-946 100/pk  
60219 4" x 4" B-946 30/pk  
60230 8" x 8" B-946 10/pk



Electrical Voltage

60235 1/2" x 1/2" B-946 100/pk  
60191 1" x 1" B-946 100/pk  
60202 2" x 2" B-946 100/pk  
60213 4" x 4" B-946 30/pk  
60224 8" x 8" B-946 10/pk



Explosive Atmosphere

60189 1/2" x 1/2" B-946 100/pk  
60200 1" x 1" B-946 100/pk  
60211 2" x 2" B-946 100/pk  
60222 4" x 4" B-946 30/pk  
60233 8" x 8" B-946 10/pk



Explosive Material

60182 1/2" x 1/2" B-946 100/pk  
60193 1" x 1" B-946 100/pk  
60204 2" x 2" B-946 100/pk  
60215 4" x 4" B-946 30/pk  
60226 8" x 8" B-946 10/pk



Flammable Material

60181 1/2" x 1/2" B-946 100/pk  
60192 1" x 1" B-946 100/pk  
60203 2" x 2" B-946 100/pk  
60214 4" x 4" B-946 30/pk  
60225 8" x 8" B-946 10/pk



Hazardous Area

60188 1/2" x 1/2" B-946 100/pk  
60199 1" x 1" B-946 100/pk  
60210 2" x 2" B-946 100/pk  
60221 4" x 4" B-946 30/pk  
60232 8" x 8" B-946 10/pk



Laser Beam

60187 1/2" x 1/2" B-946 100/pk  
60198 1" x 1" B-946 100/pk  
60209 2" x 2" B-946 100/pk  
60220 4" x 4" B-946 30/pk  
60231 8" x 8" B-946 10/pk



Radioactive Material

60185 1/2" x 1/2" B-946 100/pk  
60196 1" x 1" B-946 100/pk  
60207 2" x 2" B-946 100/pk  
60218 4" x 4" B-946 30/pk  
60229 8" x 8" B-946 10/pk



Static Sensitive Devices

60190 1/2" x 1/2" B-946 100/pk  
60201 1" x 1" B-946 100/pk  
60212 2" x 2" B-946 100/pk  
60223 4" x 4" B-946 30/pk  
60234 8" x 8" B-946 10/pk



Toxic Material

60183 1/2" x 1/2" B-946 100/pk  
60194 1" x 1" B-946 100/pk  
60205 2" x 2" B-946 100/pk  
60216 4" x 4" B-946 30/pk  
60227 8" x 8" B-946 10/pk

## CEMA Conveyor Safety Labels

- Conveyor Equipment Safety Labels help make your conveying equipment operations safer
- Made of B-302 high performance vinyl

<p><b>CAUTION</b> Do not enter Hazardous Area Authorized personnel only</p>	<p><b>CAUTION</b> Hazardous environment Respiratory protection required Authorized personnel only</p>	<p><b>CAUTION</b> Hazardous noise level Ear protection required in this area</p>	<p><b>CAUTION</b> HOT SURFACE Contact with skin may cause burns DO NOT TOUCH</p>	<p><b>CAUTION</b> Trip Hazard Be Alert Watch your step</p>
96160 2-1/5" x 5" B-302 5/pk	96168 2-1/5" x 5" B-302 5/pk	96167 2-1/5" x 5" B-302 5/pk	96171 2-1/5" x 5" B-302 5/pk	96162 2-1/5" x 5" B-302 5/pk
<p><b>DANGER</b> Climbing, sitting, walking or riding on conveyor at any time will cause severe injury or death KEEP OFF</p>	<p><b>DANGER</b> Hazardous voltage will cause severe injury or death LOCK OUT POWER before servicing</p>	<p><b>DANGER</b> Moving parts will cause severe injury KEEP AWAY</p>	<p><b>WARNING</b> Equipment starts automatically - can cause severe injury KEEP AWAY</p>	<p><b>WARNING</b> Exposed conveyors and moving parts can cause severe injury LOCK OUT POWER before removing cover or servicing</p>
96158 2-1/5" x 5" B-302 5/pk	96157 2-1/5" x 5" B-302 5/pk	96170 2-1/5" x 5" B-302 5/pk	96156 2-1/5" x 5" B-302 5/pk	96164 2-1/5" x 5" B-302 5/pk
<p><b>WARNING</b> Exposed moving parts can cause severe injury LOCK OUT POWER before removing guard</p>	<p><b>WARNING</b> Exposed screw and moving parts can cause severe injury LOCK OUT POWER before removing cover or servicing</p>	<p><b>WARNING</b> Moving equipment can cause severe injury KEEP AWAY</p>	<p><b>WARNING</b> Servicing moving or energized equipment can cause severe injury LOCK OUT POWER before servicing</p>	<p><b>WARNING</b> Servicing while pressurized can cause severe injury LOCK OUT source and RELIEVE PRESSURE before servicing</p>
96155 2-1/5" x 5" B-302 5/pk	96165 2-1/5" x 5" B-302 5/pk	96159 2-1/5" x 5" B-302 5/pk	96163 2-1/5" x 5" B-302 5/pk	96173 2-1/5" x 5" B-302 5/pk
<p><b>CAUTION</b> Risk of Electrical Shock More than one disconnected switch may be required to deenergize the equipment before servicing</p>	<p><b>DANGER</b> Hazardous Condition Entry will result in severe injury or death LOCK OUT POWER AND BLOCK HOIST before servicing</p>	<p><b>WARNING</b> Exposed conveyors and moving parts can cause severe injury LOCK OUT POWER before removing</p>	<p><b>WARNING</b> Exposed moving parts can cause severe injury LOCK OUT POWER before removing guard</p>	<p><b>WARNING</b> Exposed screw and moving parts can cause severe injury LOCK OUT POWER before removing cover or servicing</p>
96175 6" x 3" B-302 5/pk	96179 6" x 3" B-302 5/pk	96177 6" x 3" B-302 5/pk	96180 6" x 3" B-302 5/pk	96178 6" x 3" B-302 5/pk

## Write-On Inspection Labels

- Made of durable, write-on polyester
- Label size: 5/8" x 1-1/2"
- 364 identical labels per package



<p><b>ACCEPTED</b></p> <p>DATE _____ INITIALS _____</p>	<p><b>CALIBRATED</b></p> <p>BY _____ DATE _____</p> <p>DUE FOR CAL. _____</p>
82586 5/8"x1-1/2" B-744 364/pk	82589 5/8"x1-1/2" B-744 364/pk

<p><b>CALIBRATED</b></p> <p>BY _____ DATE _____</p> <p>DUE FOR CAL. _____</p>	<p><b>CALIBRATION</b></p> <p>BY _____ DATE _____</p> <p>NEXT CAL. DUE _____</p> <p>INSTRUMENT# _____</p>	<p><b>CALIBRATION NOT REQUIRED</b></p>	<p><b>CERTIFICATION</b></p> <p>BY _____ DATE _____</p> <p>DUE _____</p>	<p><b>DO NOT USE</b></p> <p>AFTER _____</p> <p>DATE _____</p>
82592 5/8"x1-1/2" B-744 364/pk	42211 5/8"x1-1/2" B-744 364/pk	82594 5/8"x1-1/2" B-744 364/pk	42217 5/8"x1-1/2" B-744 364/pk	82590 5/8"x1-1/2" B-744 364/pk

<p><b>INSPECTED</b></p> <p>DATE _____ INITIALS _____</p>	<p><b>MAINTENANCE</b></p> <p>BY _____</p> <p>DATE _____</p>	<p><b>REJECTED</b></p> <p>BY _____ DATE _____</p>	<p><b>REPAIRED BY</b></p> <p>INITIALS _____</p> <p>DATE _____</p>	<p><b>TESTED</b></p> <p>DATE _____ INITIALS _____</p>
82587 5/8"x1-1/2" B-744 364/pk	42221 5/8"x1-1/2" B-744 364/pk	82591 5/8"x1-1/2" B-744 364/pk	82593 5/8"x1-1/2" B-744 364/pk	82588 5/8"x1-1/2" B-744 364/pk





## Machine & Equipment Labels

- Labels communicate dangers and messages to those close to or working around machinery and equipment.
- Place these small labels on equipment to increase safety
- Made of B-302 self-sticking polyester



86271 3-1/2" x 5" B-302 5/pk



86864 3-1/2" x 5" B-302 5/pk



86841 3-1/2" x 5" B-302 5/pk



86842 3-1/2" x 5" B-302 5/pk



86843 3-1/2" x 5" B-302 5/pk



86844 3-1/2" x 5" B-302 5/pk



86846 3-1/2" x 5" B-302 5/pk



86889 3-1/2" x 5" B-302 5/pk

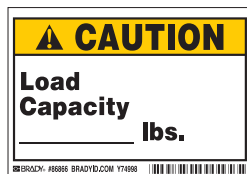

86866 3-1/2" x 5" B-302 5/pk

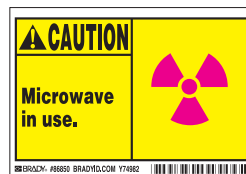

86850 3-1/2" x 5" B-302 5/pk



86847 3-1/2" x 5" B-302 5/pk

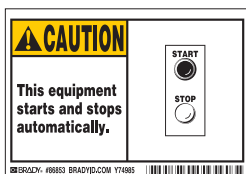

86853 3-1/2" x 5" B-302 5/pk

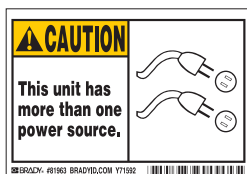

81963 3-1/2" x 5" B-302 5/pk



86857 3-1/2" x 5" B-302 5/pk



86260 3-1/2" x 5" B-302 5/pk

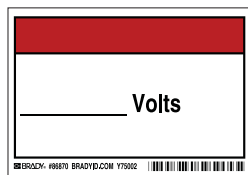

86870 3-1/2" x 5" B-302 5/pk

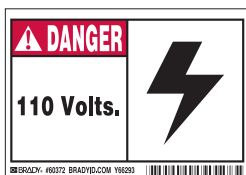

60372 3-1/2" x 5" B-302 5/pk

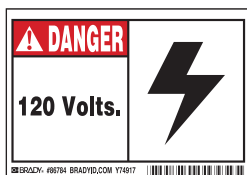

86784 3-1/2" x 5" B-302 5/pk

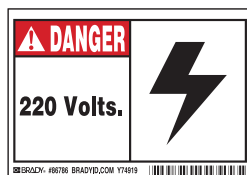

86786 3-1/2" x 5" B-302 5/pk

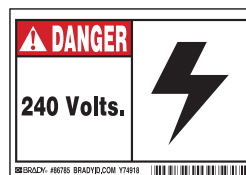

86785 3-1/2" x 5" B-302 5/pk

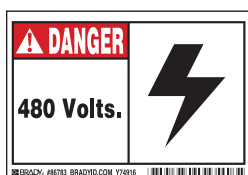

86783 3-1/2" x 5" B-302 5/pk



86789 3-1/2" x 5" B-302 5/pk



86895 3-1/2" x 5" B-302 5/pk



86898 3-1/2" x 5" B-302 5/pk



86913 3-1/2" x 5" B-302 5/pk

## Machine & Equipment Labels (Continued)

 <p><b>⚠ DANGER</b> Defective equipment.</p> <p>86792 3-1/2" x 5" B-302 5/pk</p>	 <p><b>⚠ DANGER</b> Disconnect before servicing.</p> <p>86793 3-1/2" x 5" B-302 5/pk</p>	 <p><b>⚠ DANGER</b> Do not climb, sit, walk or ride on conveyor.</p> <p>86882 3-1/2" x 5" B-302 5/pk</p>	 <p><b>⚠ DANGER</b> Do not operate unless authorized.</p> <p>86796 3-1/2" x 5" B-302 5/pk</p>	 <p><b>⚠ DANGER</b> Do not operate without guards in place.</p> <p>86797 3-1/2" x 5" B-302 5/pk</p>
 <p><b>⚠ DANGER</b> Do not operate without guards in place.</p> <p>86869 3-1/2" x 5" B-302 5/pk</p>	 <p><b>⚠ DANGER</b> Do not smoke eat or drink in this area.</p> <p>86899 3-1/2" x 5" B-302 5/pk</p>	 <p><b>⚠ DANGER</b> Ear protection required while operating this machine.</p> <p>86798 3-1/2" x 5" B-302 5/pk</p>	 <p><b>⚠ DANGER</b> Electrical hazard.</p> <p>86799 3-1/2" x 5" B-302 5/pk</p>	 <p><b>⚠ DANGER</b> Flammable</p> <p>86801 3-1/2" x 5" B-302 5/pk</p>
 <p><b>⚠ DANGER</b> Follow confined space entry procedures before entering.</p> <p>86896 3-1/2" x 5" B-302 5/pk</p>	 <p><b>⚠ DANGER</b> Hard hat area.</p> <p>86804 3-1/2" x 5" B-302 5/pk</p>	 <p><b>⚠ DANGER</b> High voltage inside.</p> <p>86861 3-1/2" x 5" B-302 5/pk</p>	 <p><b>⚠ DANGER</b> High voltage.</p> <p>86871 5" x 3-1/2" B-302 5/pk</p>	 <p><b>⚠ DANGER</b> High voltage.</p> <p>86860 3-1/2" x 5" B-302 5/pk</p>
 <p><b>⚠ DANGER</b> High voltage. Entry by authorized personnel only.</p> <p>86877 5" x 3-1/2" B-302 5/pk</p>	 <p><b>⚠ DANGER</b> High voltage. Do not enter.</p> <p>86862 3-1/2" x 5" B-302 5/pk</p>	 <p><b>⚠ DANGER</b> Hot.</p> <p>86808 3-1/2" x 5" B-302 5/pk</p>	 <p><b>⚠ DANGER</b> Keep away from machinery.</p> <p>86811 3-1/2" x 5" B-302 5/pk</p>	 <p><b>⚠ DANGER</b> Keep hands away.</p> <p>86891 3-1/2" x 5" B-302 5/pk</p>
 <p><b>⚠ DANGER</b> Keep hands clear when equipment is running.</p> <p>86886 5" x 3-1/2" B-302 5/pk</p>	 <p><b>⚠ DANGER</b> Moving machinery. Keep hands &amp; feet clear.</p> <p>86894 3-1/2" x 5" B-302 5/pk</p>	 <p>86874 3-1/2" x 5" B-302 5/pk</p>	 <p><b>⚠ DANGER</b> Never reach into moving machinery.</p> <p>86885 3-1/2" x 5" B-302 5/pk</p>	 <p><b>⚠ DANGER</b> Pinch point.</p> <p>86868 3-1/2" x 5" B-302 5/pk</p>
 <p><b>⚠ DANGER</b> Proper eye protection required.</p> <p>86867 3-1/2" x 5" B-302 5/pk</p>	 <p><b>⚠ DANGER</b> Respirator required.</p> <p>86813 3-1/2" x 5" B-302 5/pk</p>	 <p><b>⚠ DANGER</b> Starts automatically.</p> <p>86863 3-1/2" x 5" B-302 5/pk</p>	 <p><b>DANGER</b> STARTS AUTOMATICALLY</p> <p>86148 3-1/2" x 5" B-302 5/pk</p>	 <p><b>⚠ DANGER</b> 440 Volts.</p> <p>60373 3-1/2" x 5" B-302 5/pk</p>
 <p><b>⚠ DANGER</b> Watch your hands and fingers.</p> <p>86817 3-1/2" x 5" B-302 5/pk</p>	 <p><b>⚠ DANGER</b> Watch your hands and fingers.</p> <p>86887 5" x 3-1/2" B-302 5/pk</p>	 <p><b>⚠ DANGER</b> Wear face shield when using this equipment.</p> <p>86818 3-1/2" x 5" B-302 5/pk</p>	 <p><b>DANGER</b> HIGH VOLTAGE AUTHORIZED PERSONNEL ONLY <b>PELIGRO</b> ALTO VOLTAJE SOLO PERSONAL AUTORIZADO</p> <p>86235 5" x 3-1/2" B-302 5/pk</p>	 <p><b>DANGER</b> HIGH VOLTAGE AUTHORIZED PERSONNEL ONLY <b>PELIGRO</b> ALTO VOLTAJE SOLO PERSONAL AUTORIZADO</p> <p>86234 5" x 3-1/2" B-302 5/pk</p>

## Machine & Equipment Labels (Continued)

**NOTICE**  
Shut off machine when unattended.

86865 3-1/2" x 5" B-302 5/pk

**REMEMBER**  
LOCK OUT  
**ALL**  
POWER SOURCES

86248 3-1/2" x 5" B-302 5/pk

**REMEMBER**  
LOCK, TAG,  
CLEAR, TRY

86250 3-1/2" x 5" B-302 5/pk

**SAFETY FIRST**  
ALWAYS WEAR  
PROPER  
SAFETY EQUIPMENT

86194 3-1/2" x 5" B-302 5/pk

**SAFETY FIRST**  
Carelessness  
is dangerous.

86905 3-1/2" x 5" B-302 5/pk

**SAFETY FIRST**  
Dial 911  
in case of  
emergency.

86859 3-1/2" x 5" B-302 5/pk

**SAFETY FIRST**  
KEEP  
AREA  
CLEAN

86193 3-1/2" x 5" B-302 5/pk

**SAFETY FIRST**  
Keep  
area clean.

86909 3-1/2" x 5" B-302 5/pk

**SAFETY FIRST**  
Keep hands  
out of  
machinery.

86890 3-1/2" x 5" B-302 5/pk

**SAFETY FIRST**  
Lockout  
ALL  
power  
sources.

86879 3-1/2" x 5" B-302 5/pk

**SAFETY FIRST**  
REMEMBER  
WEAR SAFETY  
EQUIPMENT

86302 3-1/2" x 5" B-302 5/pk

**SAFETY FIRST**  
Lock, tag,  
clear, try.

86880 3-1/2" x 5" B-302 5/pk

**WARNING**  
Electrical  
hazard.  
Do not touch.

86900 3-1/2" x 5" B-302 5/pk

**WARNING**  
Flammable.  
No smoking or  
open flames.

86901 3-1/2" x 5" B-302 5/pk

**WARNING**  
High  
voltage.

86826 3-1/2" x 5" B-302 5/pk

**WARNING**  
Hot surface.  
Do not  
touch.

86828 3-1/2" x 5" B-302 5/pk

**WARNING**  
Keep  
guards  
in place.

86830 3-1/2" x 5" B-302 5/pk

**WARNING**  
Keep  
hands  
away.

86832 3-1/2" x 5" B-302 5/pk

**WARNING**  
Lock out  
switches  
before working  
on equipment.

86878 3-1/2" x 5" B-302 5/pk

**WARNING**  
This machine  
starts  
automatically.

86902 3-1/2" x 5" B-302 5/pk



**WARNING**  
This  
water is  
unsafe  
to drink.

86837 3-1/2" x 5" B-302 5/pk

**WARNING**  
Use  
static  
grounding  
devices.

86903 3-1/2" x 5" B-302 5/pk

**WARNING**  
Wash  
hands  
after use.

86838 3-1/2" x 5" B-302 5/pk

**WARNING**  
Watch your  
hands  
and  
fingers.

86839 3-1/2" x 5" B-302 5/pk

**10 GOOD REASONS**  
TO KEEP FINGERS  
CLEAR OFF  
THIS MACHINE

86266 5" x 3-1/2" B-302 5/pk

**BE SAFE**  
LOCK OUT-TRY OUT

86243 3-1/2" x 5" B-302 5/pk



## Machine & Equipment Labels (Continued)

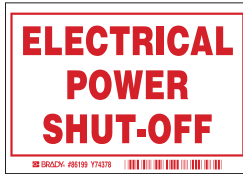

86199 3-1/2" x 5" B-302 5/pk



86218 3-1/2" x 5" B-302 5/pk



86203 3-1/2" x 5" B-302 5/pk



86246 3-1/2" x 5" B-302 5/pk



86198 3-1/2" x 5" B-302 5/pk

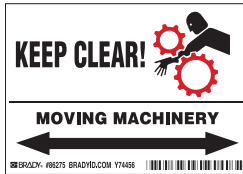

86275 3-1/2" x 5" B-302 5/pk



86270 3-1/2" x 5" B-302 5/pk

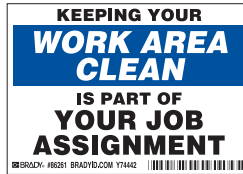

86261 3-1/2" x 5" B-302 5/pk



86245 3-1/2" x 5" B-302 5/pk



86204 3-1/2" x 5" B-302 5/pk



3WZY7 3-1/2" x 5" B-302 5/pk



86216 5" x 3-1/2" B-302 5/pk



86213 3-1/2" x 5" B-302 5/pk



86267 5" x 3-1/2" B-302 5/pk



86225 3-1/2" x 5" B-302 5/pk

Labels and Tags



## Gas Cylinder Labels

- Promote safety and safe handling of gas cylinders by posting these labels around cylinders and cylinder storage area
- Labels remove cleanly, leaving no residue on surface
- Made of B-235 self-adhesive paper



60311 3" x 5" B-235 10/pk



60312 3" x 5" B-235 10/pk



60309 3" x 5" B-235 10/pk



60313 3" x 5" B-235 10/pk



60310 3" x 5" B-235 10/pk



60314 3" x 5" B-235 10/pk



60307 3" x 5" B-235 10/pk



60308 3" x 5" B-235 10/pk

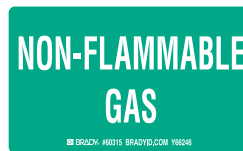

60315 3" x 5" B-235 10/pk





## Cabinet Labels

- Clearly identify cabinets containing chemicals and safety equipment
- Specially designed for placement on any size cabinet, including one-door and low capacity cabinets
- Made of B-302 self-adhesive laminated polyester



60284 3-1/2" x 12" B-302 1/pk  
60261 7" x 24" B-302 1/pk



60285 3-1/2" x 12" B-302 1/pk  
60262 7" x 24" B-302 1/pk



60286 3-1/2" x 12" B-302 1/pk  
60263 7" x 24" B-302 1/pk



60287 3-1/2" x 12" B-302 1/pk  
60264 7" x 24" B-302 1/pk



60288 3-1/2" x 12" B-302 1/pk  
60265 7" x 24" B-302 1/pk



60289 3-1/2" x 12" B-302 1/pk  
60266 7" x 24" B-302 1/pk



60290 3-1/2" x 12" B-302 1/pk  
60267 7" x 24" B-302 1/pk



60291 3-1/2" x 12" B-302 1/pk  
60268 7" x 24" B-302 1/pk



60292 3-1/2" x 12" B-302 1/pk  
60269 7" x 24" B-302 1/pk



60294 3-1/2" x 12" B-302 1/pk  
60271 7" x 24" B-302 1/pk



60295 3-1/2" x 12" B-302 1/pk  
60272 7" x 24" B-302 1/pk



60296 3-1/2" x 12" B-302 1/pk  
60273 7" x 24" B-302 1/pk



60297 3-1/2" x 12" B-302 1/pk  
60274 7" x 24" B-302 1/pk



60298 3-1/2" x 12" B-302 1/pk  
60275 7" x 24" B-302 1/pk



60299 3-1/2" x 12" B-302 1/pk  
60276 7" x 24" B-302 1/pk



60300 3-1/2" x 12" B-302 1/pk  
60277 7" x 24" B-302 1/pk



60301 3-1/2" x 12" B-302 1/pk  
60278 7" x 24" B-302 1/pk



60302 3-1/2" x 12" B-302 1/pk  
60279 7" x 24" B-302 1/pk



60303 3-1/2" x 12" B-302 1/pk  
60280 7" x 24" B-302 1/pk



60293 3-1/2" x 12" B-302 1/pk  
60270 7" x 24" B-302 1/pk



60304 3-1/2" x 12" B-302 1/pk  
60281 7" x 24" B-302 1/pk



60305 3-1/2" x 12" B-302 1/pk  
60282 7" x 24" B-302 1/pk



60306 3-1/2" x 12" B-302 1/pk  
60283 7" x 24" B-302 1/pk



## Container Labels

- Boldly pre-printed labels leave no doubt as to the contents of containers
- Self-adhesive polyester labels are constructed from laminated polyester
- Chemically resistant for longer lable life

60243 3" x 7" 25/pk	60244 3" x 7" 25/pk	60245 3" x 7" 25/pk	60246 3" x 7" 25/pk	60247 3" x 7" 25/pk	60248 3" x 7" 25/pk
60249 3" x 7" 25/pk	60250 3" x 7" 25/pk	60251 3" x 7" 25/pk	60252 3" x 7" 25/pk	60253 3" x 7" 25/pk	60254 3" x 7" 25/pk
60255 3" x 7" 25/pk	60256 3" x 7" 25/pk	60257 3" x 7" 25/pk	60258 3" x 7" 25/pk	60259 3" x 7" 25/pk	60260 3" x 7" 25/pk



## Fire Extinguisher Labels

- Fire Extinguisher labels use the most recently recommended pictorial design from NAFED (National Association of Fire Equipment Distributors)
- Label style meets the NFPA 10, 1084 Standard for Portable Fire Extinguishers Labels

45193 1-1/2"x1-1/2" B-927 6/card 95218 3" x 3" B-927 3/card	45194 1-1/2"x1-1/2" B-927 6/card 95219 3" x 3" B-927 3/card	45195 1-1/2"x1-1/2" B-927 6/card 95220 3" x 3" B-927 3/card	45196 1-1/2"x1-1/2" B-927 6/card 95221 3" x 3" B-927 3/card
95222 1-1/2" x 6" B-927 6/card	95223 1-1/2" x 6" B-927 6/card	95224 1-1/2" x 6" B-927 6/card	95225 1-1/2" x 6" B-927 6/card
95226 1-1/2" x 6" B-927 6/card	95227 1-1/2" x 6" B-927 6/card	95228 1-1/2" x 6" B-927 6/card	76303 1-1/2" x 3" B-927 3/card
"A" water based extinguishers 76299 2" x 5" B-927 5/card	"B/C" extinguishers, Carbon Dioxide, Halon 1211 and 1301, Dry Chemical. 76301 2" x 5" B-927 5/card	"A/B" extinguishers, AFFF, Foam 76300 2" x 5" B-927 5/card	"A/B/C" extinguishers, Halon 1211, Multi-Purpose Dry Chemical. 76302 2" x 5" B-927 5/card



# Labels

BradyID.com/s34

## Hard Hat Emblems

Hard hat emblems printed with safety slogans provide employees with a constant visual reminder to observe good safety practices. Emblems may also be used to identify first air personnel

- Made of self-sticking B-946 indoor outdoor vinyl and are card-mounted
- Emblem size is 2" diameter
- Glow-in-the-dark labels sold 1 per card, None glow-in-the-dark sold 4 per card



49551	49550	102027 Glow - 1/pk	49574	42229	42228	49554			
49576	42230	42231	42293	49560	49565	102030 Glow - 1/pk	42233	49562	
49567	49568	49561	42234	42294	49580	49570	42238	49556	
49579	45332	76306	42241	42242	42243	49563	49578	49558	
42244	42245	49569	42247	42248	49559	76305	42257	49571	
42262	42263	42261	49566	42541	49557	49577	49553	49552	
49555	42269	45330	102024 Glow - 1/pk	49581	102026 Glow - 1/pk	42272	42271	42273	
49572	49573	49564	42283	42284	45333	45331	102025 Glow - 1/pk	42290	



## Reflective Hard Hat Labels

- Made of silver reflective pressure sensitive vinyl so they are easy to read even in low-light conditions

Catalog #	Legend	Size	Qty.
28713	Chief	3" x 6.875"	1
28714	Emergency Medical Technician	3" x 6.875"	1
28720	Safety Officers	3" x 6.875"	1



## Reflective Hard Hat Stripes

- (50) 1-1/4" x 5" stripes per package

Catalog #	Description	Qty.
95229	1-1/4" x 5" stripes	50



## Write-On Magnetic Labels

- Re-useable labels with a water-soluble pen that wipes off with a wet cloth
- For a permanent label, use our permanent marking pen (87052)

Catalog #	Size	Color
56957	1" x 50'	Blue
56958	1" x 50'	Green
56959	1" x 50'	Orange
56960	1" x 50'	Red
56961	1" x 50'	White
56962	1" x 50'	Yellow



## Gauge Marking Labels

- Color code your gauges to easily identify acceptable or dangerous levels.
- Transparent, adhesive polyester label sheets
- Standard Package: one 9" x 10" sheet

Catalog #	Description	Color	Qty.
30697	9"x10" sheet	Red	1
30698	9"x10" sheet	Green	1
30699	9"x10" sheet	Yellow	1

## Print Your Own Custom Labels

Benchtop and portable printers offer you the opportunity to make custom labels on-demand. No need to wait for custom labels to arrive, simply print your own labels at the point of need.



**For more information view:**  
**Portable Printers..... page 288**  
**Benchtop Printers..... page 346**





## Accident Prevention Tags

- **Heavy Duty Polyester (B-837)** - Durable polyester laminate completely encapsulates and protects graphics while withstanding moisture, grease, chemicals and extreme temperatures. These tags exceed OSHA's 50 lb pull force requirement for Lockout Tagout and include 3/8" heavy duty brass grommets. Nylon ties included
- **Economy Polyester (B-851)** - Rigid polyester surface exceeds OSHA's 50 lb pull force requirement for Lockout Tagout. Tags include 3/8" rolled brass eyelets. Nylon ties included.

\* Designates tags that have a self-adhesive, clear overlamine flap which is pressed over the face of the tag for permanent protection.

† Designates tags that have a larger hole without a grommet to accommodate padlocks.

- **Cardstock (B-853)** - Cardstock tags provide an economical, yet durable material option. Attachment strings included.

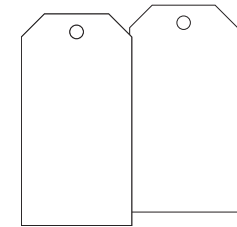

65372 3"x5-3/4" B-851 25/pk  
76198 3"x5-3/4" B-851\* 25/pk  
65349 3"x5-3/4" B-851† 25/pk

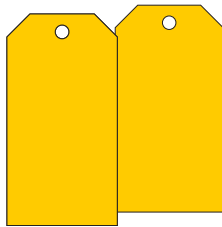

65373 3"x5-3/4" B-851 25/pk  
76197 3"x5-3/4" B-851\* 25/pk  
65350 3"x5-3/4" B-851† 25/pk



76168 3"x5-3/4" B-851 25/pk  
76193 3"x5-3/4" B-851\* 25/pk  
65348 3"x5-3/4" B-851† 25/pk



86433 5-3/4" x 3" B-837 10/pk  
86494 7" x 4" B-837 10/pk  
86552 5-3/4" x 3" B-851 10/pk  
86607 7" x 4" B-851 10/pk  
86662 5-3/4" x 3" B-853 10/pk  
86717 7" x 4" B-853 10/pk

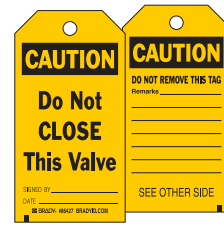

86427 5-3/4" x 3" B-837 10/pk  
86546 5-3/4" x 3" B-851 10/pk  
86601 7" x 4" B-851 10/pk  
86656 5-3/4" x 3" B-853 100/pk  
86711 7" x 4" B-853 100/pk



86426 5-3/4" x 3" B-837 10/pk  
86487 7" x 4" B-837 10/pk  
86545 5-3/4" x 3" B-851 10/pk  
86600 7" x 4" B-851 10/pk  
86655 5-3/4" x 3" B-853 100/pk  
86710 7" x 4" B-853 100/pk



86428 5-3/4" x 3" B-837 10/pk  
86547 5-3/4" x 3" B-851 10/pk  
86602 7" x 4" B-851 10/pk  
86657 5-3/4" x 3" B-853 100/pk  
86712 7" x 4" B-853 100/pk



86425 5-3/4" x 3" B-837 10/pk  
86486 7" x 4" B-837 10/pk  
86544 5-3/4" x 3" B-851 10/pk  
86599 7" x 4" B-851 10/pk  
86654 5-3/4" x 3" B-853 100/pk  
86709 7" x 4" B-853 100/pk



86424 5-3/4" x 3" B-837 10/pk  
86485 7" x 4" B-837 10/pk  
86543 5-3/4" x 3" B-851 10/pk  
86598 7" x 4" B-851 10/pk  
86653 5-3/4" x 3" B-853 100/pk  
86608 7" x 4" B-853 100/pk



86430 5-3/4" x 3" B-837 10/pk  
86549 5-3/4" x 3" B-851 10/pk  
86604 7" x 4" B-851 10/pk  
86659 5-3/4" x 3" B-853 100/pk  
86714 7" x 4" B-853 100/pk



76171 3"x5-3/4" B-851 25/pk  
76192 3"x5-3/4" B-851\* 25/pk  
65347 3"x5-3/4" B-851† 25/pk

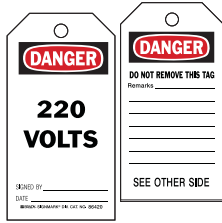

86420 5-3/4" x 3" B-837 10/pk  
86481 7" x 4" B-837 10/pk  
86539 5-3/4" x 3" B-851 10/pk  
86594 7" x 4" B-851 10/pk  
86649 5-3/4" x 3" B-853 100/pk  
86704 7" x 4" B-853 100/pk



86421 5-3/4" x 3" B-837 10/pk  
86482 7" x 4" B-837 10/pk  
86540 5-3/4" x 3" B-851 10/pk  
86595 7" x 4" B-851 10/pk  
86650 5-3/4" x 3" B-853 100/pk  
86705 7" x 4" B-853 100/pk



86431 5-3/4" x 3" B-837 10/pk  
86492 7" x 4" B-837 10/pk  
86550 5-3/4" x 3" B-851 10/pk  
86605 7" x 4" B-851 10/pk  
86660 5-3/4" x 3" B-853 100/pk  
86715 7" x 4" B-853 100/pk



86404 5-3/4" x 3" B-837 10/pk  
86465 7" x 4" B-837 10/pk  
86523 5-3/4" x 3" B-851 10/pk  
86578 7" x 4" B-851 10/pk  
86633 5-3/4" x 3" B-853 100/pk  
86688 7" x 4" B-853 100/pk

## Accident Prevention Tags (Continued)



86407 5-3/4" x 3" B-837 10/pk  
86468 7" x 4" B-837 10/pk  
86526 5-3/4" x 3" B-851 10/pk  
86581 7" x 4" B-851 10/pk  
86636 5-3/4" x 3" B-853 100/pk  
86691 7" x 4" B-853 100/pk



86406 5-3/4" x 3" B-837 10/pk  
86467 7" x 4" B-837 10/pk  
86525 5-3/4" x 3" B-851 10/pk  
86580 7" x 4" B-851 10/pk  
86635 5-3/4" x 3" B-853 100/pk  
86690 7" x 4" B-853 100/pk

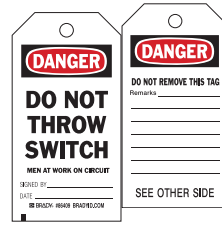

86409 5-3/4" x 3" B-837 10/pk  
86470 7" x 4" B-837 10/pk  
86528 5-3/4" x 3" B-851 10/pk  
86583 7" x 4" B-851 10/pk  
86638 5-3/4" x 3" B-853 100/pk  
86693 7" x 4" B-853 100/pk



86414 5-3/4" x 3" B-837 10/pk  
86475 7" x 4" B-837 10/pk  
86533 5-3/4" x 3" B-851 10/pk  
86588 7" x 4" B-851 10/pk  
86643 5-3/4" x 3" B-853 100/pk  
86698 7" x 4" B-853 100/pk



86403 5-3/4" x 3" B-837 10/pk  
86464 7" x 4" B-837 10/pk  
86522 5-3/4" x 3" B-851 10/pk  
86577 7" x 4" B-851 10/pk  
86632 5-3/4" x 3" B-853 100/pk  
86687 7" x 4" B-853 100/pk



86411 5-3/4" x 3" B-837 10/pk  
86472 7" x 4" B-837 10/pk  
86530 5-3/4" x 3" B-851 10/pk  
86585 7" x 4" B-851 10/pk  
86640 5-3/4" x 3" B-853 100/pk  
86695 7" x 4" B-853 100/pk



86422 5-3/4" x 3" B-837 10/pk  
86483 7" x 4" B-837 10/pk  
86541 5-3/4" x 3" B-851 10/pk  
86596 7" x 4" B-851 10/pk  
86651 5-3/4" x 3" B-853 100/pk  
86706 7" x 4" B-853 100/pk

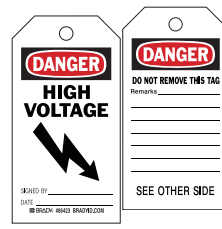

86423 5-3/4" x 3" B-837 10/pk  
86484 7" x 4" B-837 10/pk  
86542 5-3/4" x 3" B-851 10/pk  
86597 7" x 4" B-851 10/pk  
86652 5-3/4" x 3" B-853 100/pk  
86707 7" x 4" B-853 100/pk



86415 5-3/4" x 3" B-837 10/pk  
86476 7" x 4" B-837 10/pk  
86534 5-3/4" x 3" B-851 10/pk  
86589 7" x 4" B-851 10/pk  
86644 5-3/4" x 3" B-853 100/pk  
86699 7" x 4" B-853 100/pk

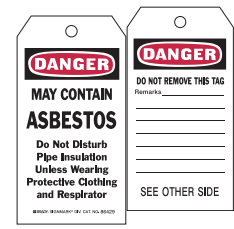

86429 5-3/4" x 3" B-837 10/pk  
86490 7" x 4" B-837 10/pk  
86548 5-3/4" x 3" B-851 10/pk  
86603 7" x 4" B-851 10/pk  
86658 5-3/4" x 3" B-853 100/pk  
86713 7" x 4" B-853 100/pk



86408 5-3/4" x 3" B-837 10/pk  
86469 7" x 4" B-837 10/pk  
86527 5-3/4" x 3" B-851 10/pk  
86582 7" x 4" B-851 10/pk  
86637 5-3/4" x 3" B-853 100/pk  
86692 7" x 4" B-853 100/pk



86410 5-3/4" x 3" B-837 10/pk  
86471 7" x 4" B-837 10/pk  
86529 5-3/4" x 3" B-851 10/pk  
86584 7" x 4" B-851 10/pk  
86639 5-3/4" x 3" B-853 100/pk  
86694 7" x 4" B-853 100/pk



86432 5-3/4" x 3" B-837 10/pk  
86493 7" x 4" B-837 10/pk  
86551 5-3/4" x 3" B-851 10/pk  
86606 7" x 4" B-851 10/pk  
86661 5-3/4" x 3" B-853 100/pk  
86716 7" x 4" B-853 100/pk



86416 5-3/4" x 3" B-837 10/pk  
86535 5-3/4" x 3" B-851 10/pk  
86590 7" x 4" B-851 10/pk  
86645 5-3/4" x 3" B-853 100/pk  
86700 7" x 4" B-853 100/pk



86413 5-3/4" x 3" B-837 10/pk  
86474 7" x 4" B-837 10/pk  
86532 5-3/4" x 3" B-851 10/pk  
86587 7" x 4" B-851 10/pk  
86642 5-3/4" x 3" B-853 100/pk  
86697 7" x 4" B-853 100/pk

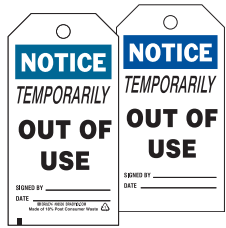

86417 5-3/4" x 3" B-837 10/pk  
86478 7" x 4" B-837 10/pk  
86536 5-3/4" x 3" B-851 10/pk  
86591 7" x 4" B-851 10/pk  
86646 5-3/4" x 3" B-853 100/pk  
86701 7" x 4" B-853 100/pk



86405 5-3/4" x 3" B-837 10/pk  
86466 7" x 4" B-837 10/pk  
86524 5-3/4" x 3" B-851 10/pk  
86579 7" x 4" B-851 10/pk  
86634 5-3/4" x 3" B-853 100/pk  
86689 7" x 4" B-853 100/pk



86553 5-3/4" x 3" B-851 10/pk  
86708 7" x 4" B-851 10/pk  
86663 5-3/4" x 3" B-853 100/pk  
86718 7" x 4" B-853 100/pk



86434 5-3/4" x 3" B-837 10/pk  
86496 7" x 4" B-837 10/pk  
86554 5-3/4" x 3" B-851 10/pk  
86609 7" x 4" B-851 10/pk  
86664 5-3/4" x 3" B-853 100/pk  
86719 7" x 4" B-853 100/pk



86418 5-3/4" x 3" B-837 10/pk  
86537 5-3/4" x 3" B-851 10/pk  
86592 7" x 4" B-851 10/pk  
86647 5-3/4" x 3" B-853 100/pk  
86702 7" x 4" B-853 100/pk



## Confined Space Tags

- **Heavy Duty Polyester (B-837)** - Durable polyester laminate completely encapsulates and protects graphics while withstanding moisture, grease, chemicals and extreme temperatures. These tags exceed OSHA's 50 lb pull force requirement for Lockout Tagout and include 3/8" heavy duty brass grommets. Nylon ties included
- **Economy Polyester (B-851)** - Rigid polyester surface exceeds OSHA's 50 lb pull force requirement for Lockout Tagout. Tags include 3/8" rolled brass eyelets. Nylon ties included.
- **Cardstock (B-853)** - Cardstock tags provide an economical, yet durable material option. Attachment strings included.

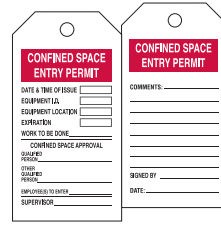

49234 5-3/4" x 3" B-837 25/pk  
49228 5-3/4" x 3" B-851 25/pk

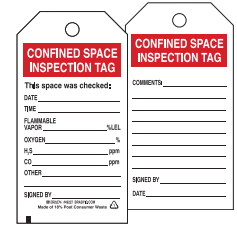

50275 5-3/4" x 3" B-837 25/pk  
49227 5-3/4" x 3" B-851 25/pk

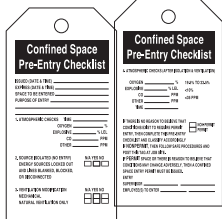

66322 5-3/4" x 3" B-837 25/pk  
66324 5-3/4" x 3" B-851 25/pk  
65457 5-3/4" x 3" B-853 25/pk



50248 5-3/4" x 3" B-837 25/pk  
50282 5-3/4" x 3" B-851 25/pk



50287 5-3/4" x 3" B-837 25/pk  
50286 5-3/4" x 3" B-851 25/pk



50291 5-3/4" x 3" B-837 25/pk  
50290 5-3/4" x 3" B-851 25/pk



65299 5-3/4" x 3" B-837 25/pk  
65270 5-3/4" x 3" B-851 25/pk  
65456 5-3/4" x 3" B-853 25/pk

## Isolation Blind Tags

- Made from 10-mil polyester (B-851) and has excellent outdoor weather resistance
- 3" x 5-3/4" tag with 3/8" dia. hole with rolled brass eyelet
- Exceeds OSHA 50-lb pull strength requirement for Tagout
- Includes 25 nylon cable ties



132421 5-3/4" x 3" B-851 25/pk



132422 5-3/4" x 3" B-851 25/pk



132424 5-3/4" x 3" B-851 25/pk



132423 5-3/4" x 3" B-851 25/pk



132425 5-3/4" x 3" B-851 25/pk



**Customize It!** Flag-Style Blind Notification Tags can be customized with text, serialization, and perforation (for safe record keeping).

Call Brady Customer Service to get a quote today!

## Flag Style Blind Tag

- Made from 10-mil polyester (B-851)
- 3/8" diameter hole with rolled brass eyelet
- Excellent outdoor weather resistance, highly visual for safety warnings
- Exceeds OSHA 50-lb pull strength requirement for Tagout
- Includes 25 nylon cable ties

Catalog #	Legend	Size	Color	Qty.
132452	Install Blind Here	2" x 20"	Black on Green	25
132453	Isolation Blind	2" x 20"	Black on Red	25
132454	Blind Installed	2" x 20"	Black on Red	25



## Inspection / Material Control Tags

- Tags meet OSHA Standard 1910.145 for accident prevention
- B-837 Heavy Duty Laminated Polyester tags meet OSHA's 50 lb. pull force requirement for Tagout and have superior chemical resistance. These plastic tags are encapsulated in matte polyester laminate for superior durability. Nylon ties included.
- B-851 Economy Polyester tags meet OSHA's 50 lb. pull force requirement for Tagout and have moderate chemical resistance. Nylon ties included.
- B-853 Cardstock tags provide an economical, yet durable material option. Attachment strings included.

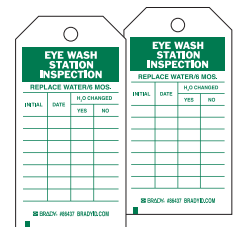
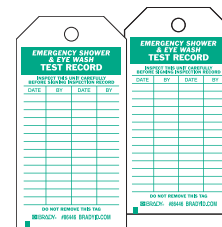

### Recharge Maintenance / Inspection Tags

76222 5-3/4" x 3" B-851 25/pk

65371 5-3/4" x 3" B-851 25/pk

86435	5-3/4" x 3"	B-837	10/pk
86497	7" x 4"	B-837	10/pk
86562	5-3/4" x 3"	B-851	10/pk
86617	7" x 4"	B-851	10/pk
86672	5-3/4" x 3"	B-853	100/pk
86727	7" x 4"	B-853	100/pk

86446	5-3/4" x 3"	B-837	10/pk
86508	7" x 4"	B-837	10/pk
86560	5-3/4" x 3"	B-851	10/pk
86615	7" x 4"	B-851	10/pk
86670	5-3/4" x 3"	B-853	100/pk
86725	7" x 4"	B-853	100/pk

86437	5-3/4" x 3"	B-837	10/pk
86499	7" x 4"	B-837	10/pk
86564	5-3/4" x 3"	B-851	10/pk
86619	7" x 4"	B-851	10/pk
86674	5-3/4" x 3"	B-853	100/pk
86729	7" x 4"	B-853	100/pk

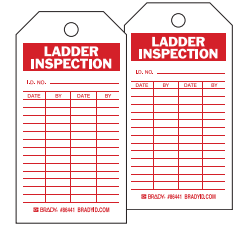
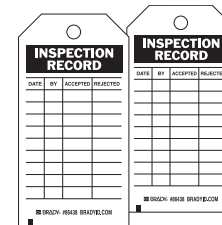
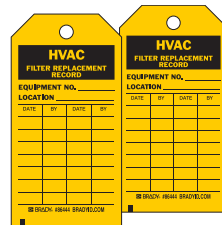

86444	5-3/4" x 3"	B-837	10/pk
86506	7" x 4"	B-837	10/pk
86558	5-3/4" x 3"	B-851	10/pk
86613	7" x 4"	B-851	10/pk
86668	5-3/4" x 3"	B-853	100/pk
86723	7" x 4"	B-853	100/pk

86438	5-3/4" x 3"	B-837	10/pk
86500	7" x 4"	B-837	10/pk
86565	5-3/4" x 3"	B-853	100/pk
86620	7" x 4"	B-851	10/pk
86675	5-3/4" x 3"	B-853	100/pk
86730	7" x 4"	B-853	100/pk

86441	5-3/4" x 3"	B-837	10/pk
86503	7" x 4"	B-837	10/pk
86555	5-3/4" x 3"	B-851	10/pk
86610	7" x 4"	B-851	10/pk
86665	5-3/4" x 3"	B-853	100/pk
86720	7" x 4"	B-853	100/pk

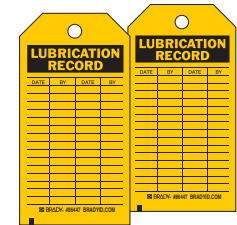

86447	5-3/4" x 3"	B-837	10/pk
86509	7" x 4"	B-837	10/pk
86561	5-3/4" x 3"	B-851	10/pk
86616	7" x 4"	B-851	10/pk
86671	5-3/4" x 3"	B-853	100/pk
86726	7" x 4"	B-853	100/pk

86445	5-3/4" x 3"	B-837	10/pk
86559	5-3/4" x 3"	B-851	10/pk
86614	7" x 4"	B-851	10/pk
86669	5-3/4" x 3"	B-853	100/pk
86724	7" x 4"	B-853	100/pk

86449	5-3/4" x 3"	B-837	10/pk
86511	7" x 4"	B-837	10/pk
86569	5-3/4" x 3"	B-851	10/pk
86624	7" x 4"	B-851	10/pk
86679	5-3/4" x 3"	B-853	100/pk
86734	7" x 4"	B-853	100/pk

86442	5-3/4" x 3"	B-837	10/pk
86504	7" x 4"	B-837	10/pk
86556	5-3/4" x 3"	B-851	10/pk
86611	7" x 4"	B-851	10/pk
86666	5-3/4" x 3"	B-853	100/pk
86721	7" x 4"	B-853	100/pk

86443	5-3/4" x 3"	B-837	10/pk
86505	7" x 4"	B-837	10/pk
86557	5-3/4" x 3"	B-851	10/pk
86612	7" x 4"	B-851	10/pk
86667	5-3/4" x 3"	B-853	100/pk
86722	7" x 4"	B-853	100/pk

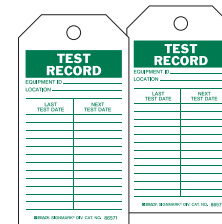
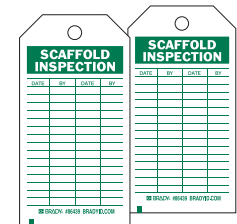

86439	5-3/4" x 3"	B-837	10/pk
86501	7" x 4"	B-837	10/pk
86566	5-3/4" x 3"	B-851	10/pk
86621	7" x 4"	B-851	10/pk
86676	5-3/4" x 3"	B-853	100/pk
86731	7" x 4"	B-853	100/pk

86450	5-3/4" x 3"	B-837	10/pk
86512	7" x 4"	B-837	10/pk
86570	5-3/4" x 3"	B-851	10/pk
86625	7" x 4"	B-851	10/pk
86680	5-3/4" x 3"	B-853	100/pk
86735	7" x 4"	B-853	100/pk

86436	5-3/4" x 3"	B-837	10/pk
86498	7" x 4"	B-837	10/pk
86563	5-3/4" x 3"	B-851	10/pk
86618	7" x 4"	B-851	10/pk
86673	5-3/4" x 3"	B-853	100/pk
86728	7" x 4"	B-853	100/pk

86451	5-3/4" x 3"	B-837	10/pk
86513	7" x 4"	B-837	10/pk
86571	5-3/4" x 3"	B-851	10/pk
86626	7" x 4"	B-851	10/pk
86681	5-3/4" x 3"	B-853	100/pk
86736	7" x 4"	B-853	100/pk

86448	5-3/4" x 3"	B-837	10/pk
86510	7" x 4"	B-837	10/pk
86568	5-3/4" x 3"	B-851	10/pk
86623	7" x 4"	B-851	10/pk
86678	5-3/4" x 3"	B-853	100/pk
86733	7" x 4"	B-853	100/pk

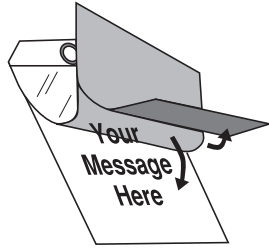

## Self-Laminating Tags

- Self-laminating tags can be personalized by writing on special instructions, hazards or warning. Then protect and seal your message with the clear adhesive overlay.
- Constructed of B-851 Economy Polyester with a 1 mil polyester overlay
- Meet OSHA's 50 lb. pull force requirement for Tagout and have moderate chemical resistance. Nylon ties included.



86455 5-3/4" x 3" B-851 10/pk  
81991 7" x 4" B-851 10/pk



86460 5-3/4" x 3" B-851 10/pk  
86518 7" x 4" B-851 10/pk



86458 5-3/4" x 3" B-851 10/pk  
86516 7" x 4" B-851 10/pk



65501 5-3/4" x 3" B-851 10/pk  
96222 7" x 4" B-851 10/pk



86461 5-3/4" x 3" B-851 10/pk  
86519 7" x 4" B-851 10/pk



86459 5-3/4" x 3" B-851 10/pk  
86517 7" x 4" B-851 10/pk



86456 5-3/4" x 3" B-851 10/pk  
86514 7" x 4" B-851 10/pk



86457 5-3/4" x 3" B-851 10/pk  
86515 7" x 4" B-851 10/pk



## Cylinder Status Tags

- Clearly inform user of status of cylinder contents
- Available in a the following materials:
  - B-851 - Economy Polyester (10/pack with nylon fasteners)
  - B-853 - Cardstock (100/pack with string fasteners)

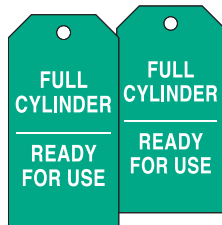

17926 5-3/4" x 3" B-851 10/pk  
17925 5-3/4" x 3" B-853 100/pk



17928 5-3/4" x 3" B-851 10/pk  
17927 5-3/4" x 3" B-853 100/pk



17924 5-3/4" x 3" B-851 10/pk  
17923 5-3/4" x 3" B-853 100/pk



## Production Status Tags

- Designed to help you monitor and control production and equipment maintenance
- Made of durable B-853 cardstock with 3/8" metal grommet. String attachments included
- All tag backs are blank

**CALIBRATION**

EQUIPMENT NO. \_\_\_\_\_  
 DESCRIPTION \_\_\_\_\_  
 BY \_\_\_\_\_ DATE \_\_\_\_\_  
 NEXT CAL. DUE \_\_\_\_\_

BRADY #8763 BRADYID.COM

86743 3" x 5-3/4" B-853 100/pk

**DEFECTIVE DO NOT USE**

NO. # \_\_\_\_\_  
 SERIALIZED BY \_\_\_\_\_ DATE \_\_\_\_\_

BRADY #8765 BRADYID.COM

86750 3" x 5-3/4" B-853 100/pk

**DO NOT USE**

NO. # \_\_\_\_\_  
 SERIALIZED BY \_\_\_\_\_ DATE \_\_\_\_\_

BRADY #8763 BRADYID.COM

86753 3" x 5-3/4" B-853 100/pk

**ACCEPTED**

CUSTOMER \_\_\_\_\_ DATE \_\_\_\_\_  
 NO. PCS. \_\_\_\_\_ MATERIAL \_\_\_\_\_  
 PART NO. \_\_\_\_\_ SER. NO. \_\_\_\_\_  
 PART NAME \_\_\_\_\_  
 INSPECTOR \_\_\_\_\_

BRADY #8775 BRADYID.COM

86775 3" x 5-3/4" B-853 100/pk

**APPROVED FOR SHIPMENT**

PART NO. \_\_\_\_\_  
 PART NAME \_\_\_\_\_  
 LOT NO. \_\_\_\_\_  
 INSPECTED BY \_\_\_\_\_

BRADY #8774 BRADYID.COM

86774 3" x 5-3/4" B-853 100/pk

**HAZARDOUS WASTE**

DESCRIPTION \_\_\_\_\_  
 SOURCE \_\_\_\_\_ SOLID \_\_\_\_\_  
 LIQUID \_\_\_\_\_  
 HAZARDOUS  TOXIC  CORROSIVE  REACTIVE   
 BY \_\_\_\_\_ DATE \_\_\_\_\_

BRADY #8763 BRADYID.COM

86763 3" x 5-3/4" B-853 100/pk

**HOIST INSPECTED O.K. FOR USE**

SERIALIZED BY \_\_\_\_\_ DATE \_\_\_\_\_

BRADY #8762 BRADYID.COM

86762 3" x 5-3/4" B-853 100/pk

**HOLD**

NO. # \_\_\_\_\_  
 SERIALIZED BY \_\_\_\_\_ DATE \_\_\_\_\_

BRADY #8764 BRADYID.COM

86746 3" x 5-3/4" B-853 100/pk

**HOLD**

DATE \_\_\_\_\_  
 BY \_\_\_\_\_  
 REASON \_\_\_\_\_  
 RELEASED BY \_\_\_\_\_  
 DATE \_\_\_\_\_

BRADY #8747 BRADYID.COM

86747 3" x 5-3/4" B-853 100/pk

**HOLD-DO NOT USE!**

PART NAME \_\_\_\_\_ JOB NO. \_\_\_\_\_  
 PART NO. \_\_\_\_\_ QUANTITY \_\_\_\_\_  
 SERIAL NO. \_\_\_\_\_  
 REMARKS \_\_\_\_\_  
 INSPECTOR \_\_\_\_\_ DATE \_\_\_\_\_

BRADY #8752 BRADYID.COM

86752 3" x 5-3/4" B-853 100/pk

**INVENTORY**

JOB NO. \_\_\_\_\_ PG. NO. \_\_\_\_\_  
 PART NO. \_\_\_\_\_ QUANTITY \_\_\_\_\_  
 DESCRIPTION \_\_\_\_\_  
 LOCATION \_\_\_\_\_  
 REMARKS \_\_\_\_\_  
 COUNTED BY \_\_\_\_\_ CHECKED BY \_\_\_\_\_ DATE \_\_\_\_\_

BRADY #8748 BRADYID.COM

86748 3" x 5-3/4" B-853 100/pk

**INSPECTION**

NO. # \_\_\_\_\_  
 SERIALIZED BY \_\_\_\_\_ DATE \_\_\_\_\_

BRADY #8749 BRADYID.COM

86749 3" x 5-3/4" B-853 100/pk

**IDENTIFICATION**

DESCRIPTION \_\_\_\_\_ SERIAL NO. \_\_\_\_\_  
 JOB NO. \_\_\_\_\_ P.D. NO. \_\_\_\_\_  
 QUANTITY \_\_\_\_\_  
 BY \_\_\_\_\_ DATE \_\_\_\_\_

BRADY #8740 BRADYID.COM

86740 3" x 5-3/4" B-853 100/pk

**INSPECTED**

NO. # \_\_\_\_\_  
 SERIALIZED BY \_\_\_\_\_ DATE \_\_\_\_\_

BRADY #8772 BRADYID.COM

86772 3" x 5-3/4" B-853 100/pk

**INVENTORY**

JOB NO. \_\_\_\_\_ PG. NO. \_\_\_\_\_  
 PART NO. \_\_\_\_\_ QUANTITY \_\_\_\_\_  
 DESCRIPTION \_\_\_\_\_  
 LOCATION \_\_\_\_\_  
 REMARKS \_\_\_\_\_  
 COUNTED BY \_\_\_\_\_ CHECKED BY \_\_\_\_\_ DATE \_\_\_\_\_

BRADY #8768 BRADYID.COM

86768 3" x 5-3/4" B-853 100/pk

**NON-CONFORMING**

PART NO. \_\_\_\_\_ SERIAL NO. \_\_\_\_\_  
 PART NAME \_\_\_\_\_  
 CUSTOMER \_\_\_\_\_  
 P.D. NO. DATE \_\_\_\_\_ NO. PIECES \_\_\_\_\_  
 REASON \_\_\_\_\_  
 INSPECTOR \_\_\_\_\_ DATE \_\_\_\_\_

BRADY #8779 BRADYID.COM

86779 3" x 5-3/4" B-853 100/pk

**O.K. TO SHIP**

NO. # \_\_\_\_\_  
 SERIALIZED BY \_\_\_\_\_ DATE \_\_\_\_\_

BRADY #8773 BRADYID.COM

86773 3" x 5-3/4" B-853 100/pk

**O.K. TO USE**

JOB NO. \_\_\_\_\_ P.D. NO. \_\_\_\_\_  
 DESCRIPTION \_\_\_\_\_  
 QUANTITY \_\_\_\_\_  
 BY \_\_\_\_\_ DATE \_\_\_\_\_

BRADY #8761 BRADYID.COM

86761 3" x 5-3/4" B-853 100/pk

**OK TO ASSEMBLE**

JOB NO. \_\_\_\_\_ SERIAL NO. \_\_\_\_\_  
 PART NO. \_\_\_\_\_  
 DESCRIPTION \_\_\_\_\_  
 COMMENTS \_\_\_\_\_  
 BY \_\_\_\_\_ DATE \_\_\_\_\_

BRADY #8760 BRADYID.COM

86760 3" x 5-3/4" B-853 100/pk

**OUT OF SERVICE**

DATE \_\_\_\_\_  
 SERIALIZED BY \_\_\_\_\_  
 LOCATION \_\_\_\_\_  
 PROBLEM \_\_\_\_\_  
 SERIALIZED BY \_\_\_\_\_ DATE \_\_\_\_\_

BRADY #8751 BRADYID.COM

86751 3" x 5-3/4" B-853 100/pk

**OUT OF SERVICE**

DATE \_\_\_\_\_  
 SERIALIZED BY \_\_\_\_\_  
 LOCATION \_\_\_\_\_  
 PROBLEM \_\_\_\_\_  
 SERIALIZED BY \_\_\_\_\_ DATE \_\_\_\_\_

BRADY #8757 BRADYID.COM

86757 3" x 5-3/4" B-853 100/pk

**OUT OF STOCK**

PART NO. \_\_\_\_\_  
 DESCRIPTION \_\_\_\_\_  
 LOCATION \_\_\_\_\_  
 COMMENTS \_\_\_\_\_  
 BY \_\_\_\_\_ DATE \_\_\_\_\_

BRADY #8769 BRADYID.COM

86769 3" x 5-3/4" B-853 100/pk

**Q.A. APPROVED**

NO. # \_\_\_\_\_  
 SERIALIZED BY \_\_\_\_\_ DATE \_\_\_\_\_

BRADY #8771 BRADYID.COM

86771 3" x 5-3/4" B-853 100/pk

**RE-WORK**

NO. # \_\_\_\_\_  
 SERIALIZED BY \_\_\_\_\_ DATE \_\_\_\_\_

BRADY #8744 BRADYID.COM

86744 3" x 5-3/4" B-853 100/pk

**READY FOR SERVICE**

NO. # \_\_\_\_\_  
 SERIALIZED BY \_\_\_\_\_ DATE \_\_\_\_\_

BRADY #8745 BRADYID.COM

86745 3" x 5-3/4" B-853 100/pk

**REJECTED**

JOB NO. \_\_\_\_\_ PG. NO. \_\_\_\_\_  
 PART NO. \_\_\_\_\_ SERIAL NO. \_\_\_\_\_  
 PART NAME \_\_\_\_\_  
 NUMBER OF PIECES REJECTED \_\_\_\_\_  
 REASON \_\_\_\_\_  
 DISPOSITION \_\_\_\_\_  
 INSPECTOR \_\_\_\_\_ DATE \_\_\_\_\_

BRADY #8780 BRADYID.COM

86780 3" x 5-3/4" B-853 100/pk

**REJECTED**

JOB NO. \_\_\_\_\_ PG. NO. \_\_\_\_\_  
 PART NO. \_\_\_\_\_ SERIAL NO. \_\_\_\_\_  
 PART NAME \_\_\_\_\_  
 NUMBER OF PIECES REJECTED \_\_\_\_\_  
 REASON \_\_\_\_\_  
 DISPOSITION \_\_\_\_\_  
 INSPECTOR \_\_\_\_\_ DATE \_\_\_\_\_

BRADY #8781 BRADYID.COM

86781 3" x 5-3/4" B-853 100/pk

**RELEASE**

PART NO. \_\_\_\_\_  
 DESCRIPTION \_\_\_\_\_  
 QUANTITY \_\_\_\_\_  
 INSPECTOR \_\_\_\_\_ DATE \_\_\_\_\_

BRADY #8755 BRADYID.COM

86755 3" x 5-3/4" B-853 100/pk

**REPAIR**

NO. # \_\_\_\_\_  
 SERIALIZED BY \_\_\_\_\_ DATE \_\_\_\_\_

BRADY #8776 BRADYID.COM

86776 3" x 5-3/4" B-853 100/pk

**REPAIRABLE OR REWORK**

CUSTOMER \_\_\_\_\_ DATE \_\_\_\_\_  
 JOB NO. \_\_\_\_\_ PART NAME \_\_\_\_\_  
 PART NO. \_\_\_\_\_ SER. NO. \_\_\_\_\_  
 NO. OF PIECES \_\_\_\_\_  
 DISPOSITION \_\_\_\_\_  
 REASON FOR REWORK \_\_\_\_\_  
 STAMP \_\_\_\_\_  
 BY \_\_\_\_\_ DATE \_\_\_\_\_

BRADY #8777 BRADYID.COM

86777 3" x 5-3/4" B-853 100/pk

**REPAIRED**

EQUIPMENT I.D. \_\_\_\_\_  
 DESCRIPTION \_\_\_\_\_ SERIAL NO. \_\_\_\_\_  
 JOB NO. \_\_\_\_\_  
 CONVENTION \_\_\_\_\_  
 BY \_\_\_\_\_ DATE \_\_\_\_\_

BRADY #8778 BRADYID.COM

86778 3" x 5-3/4" B-853 100/pk

**RETURN TO STOCK**

NO. # \_\_\_\_\_  
 SERIALIZED BY \_\_\_\_\_ DATE \_\_\_\_\_

BRADY #8767 BRADYID.COM

86767 3" x 5-3/4" B-853 100/pk

**RETURN TO VENDOR**

VENDOR NAME \_\_\_\_\_  
 REL. NO. \_\_\_\_\_  
 QUANTITY \_\_\_\_\_  
 COMMENTS \_\_\_\_\_  
 BY \_\_\_\_\_ DATE \_\_\_\_\_

BRADY #8765 BRADYID.COM

86765 3" x 5-3/4" B-853 100/pk

**TO VENDOR**

NO. # \_\_\_\_\_  
 SERIALIZED BY \_\_\_\_\_ DATE \_\_\_\_\_

BRADY #8764 BRADYID.COM

86764 3" x 5-3/4" B-853 100/pk

**RETURNED GOODS**

CUSTOMER \_\_\_\_\_  
 DATE \_\_\_\_\_  
 NO. OF PIECES \_\_\_\_\_  
 PROBLEM \_\_\_\_\_

BRADY #8766 BRADYID.COM

86766 3" x 5-3/4" B-853 100/pk

**SAMPLE**

NO. # \_\_\_\_\_  
 SERIALIZED BY \_\_\_\_\_ DATE \_\_\_\_\_

BRADY #8759 BRADYID.COM

86759 3" x 5-3/4" B-853 100/pk

**SCRAP**

NO. # \_\_\_\_\_  
 SERIALIZED BY \_\_\_\_\_ DATE \_\_\_\_\_

BRADY #8758 BRADYID.COM

86758 3" x 5-3/4" B-853 100/pk

**INSTRUCTIONS**

NO. # \_\_\_\_\_  
 SERIALIZED BY \_\_\_\_\_ DATE \_\_\_\_\_

BRADY #8741 BRADYID.COM

86741 3" x 5-3/4" B-853 100/pk

**TESTED**

BATCH NO. \_\_\_\_\_ QUANTITY \_\_\_\_\_  
 PART NO. \_\_\_\_\_ JOB NO. \_\_\_\_\_  
 DESCRIPTION \_\_\_\_\_  
 REMARKS \_\_\_\_\_  
 BY \_\_\_\_\_ DATE \_\_\_\_\_

BRADY #8770 BRADYID.COM

86770 3" x 5-3/4" B-853 100/pk

**WORK ORDER**

NO. # \_\_\_\_\_  
 DESCRIPTION \_\_\_\_\_  
 QUANTITY \_\_\_\_\_  
 COMMENTS \_\_\_\_\_  
 BY \_\_\_\_\_ DATE \_\_\_\_\_

BRADY #8742 BRADYID.COM

86742 3" x 5-3/4" B-853 100/pk

# Blank Tags

BradyID.com/s34

## Blank Heavy Duty Tags

- Blank paper tags are an economical and convenient way to label equipment
- Standard package: 1000 tags



Available in Standard and Fluorescent Colors.

Size	Standard Colors										Fluorescent Colors				
	White	Yellow	Pink	Orange	Green	Dark Green	Blue	Dark Blue	Lavender	Gray	FL. Green	FL. Red	FL. Orange	FL. Yellow	FL. Pink
2.75" x 1.375"	102160	102136	102120	102128	-	102144	102088	102096	102152	102104	102064	102080	102048	102072	102056
3.25" x 1.625"	102161	102137	102121	102129	102113	102145	102089	102097	102153	102105	-	102081	102049	102073	102057
3.75" x 1.875"	102162	102138	102122	102130	102114	102146	102090	102098	102154	102106	102066	102082	102050	102074	102058
4.25" x 2.125"	102163	102139	102123	102131	102115	102147	102091	102099	102155	102107	102067	102083	102051	102075	102059
4.75" x 2.375"	102164	102140	102124	102132	102116	102148	102092	102100	-	102108	102068	102084	102052	102076	102060
5.25" x 2.625"	102165	102141	102125	102133	102117	102149	102093	102101	102157	102109	102069	102085	102053	102077	102061
5.75" x 2.875"	102166	102142	102126	102134	102118	102150	102094	102102	102158	102110	102070	102086	102054	102078	102062
6.25" x 3.125"	102167	102143	102127	102135	102119	102151	102095	102103	102159	102111	102071	102087	102055	102079	102063



## Blank Manila Tags

- Weatherproof, tear proof & lightweight
- More durable than cardstock and include metal eyelets.

Catalog #	Size	Color	Qty.
102040	2.75" x 1.375"	Manila	1000
102041	3.25" x 1.625"	Manila	1000
102042	3.75" x 1.875"	Manila	1000
102043	4.25" x 2.125"	Manila	1000
102044	4.75" x 2.375"	Manila	1000
102045	5.25" x 2.625"	Manila	1000
102046	5.75" x 2.875"	Manila	1000
102047	6.25" x 3.125"	Manila	1000



## Tyvek Blank Tags

- Weatherproof, tear proof & lightweight
- More durable than cardstock and include metal eyelets.

Catalog #	Size	Color	Qty.
102032	2.75" x 1.375"	White Tyvek	1000
102033	3.25" x 1.625"	White Tyvek	1000
102034	3.75" x 1.875"	White Tyvek	1000
102035	4.25" x 2.125"	White Tyvek	1000
102036	4.75" x 2.375"	White Tyvek	1000
102037	5.25" x 2.625"	White Tyvek	1000
102038	5.75" x 2.875"	White Tyvek	1000
102039	6.25" x 3.125"	White Tyvek	1000



## Aluminum Write-On Tags

- B-184 Dead Soft Aluminum Foil laminated to a cardboard backing (includes plastic lock-on ties)
- Long-lasting indoor performance for handwritten or typed images (Not intended for outdoor use)

Catalog #	Description	Qty.
23199	3-1/2" x 1/8" Aluminum Write-On Tags	25/pk



## Self-Laminating Blank Tags

- Flexible and versatile tags perform multiple roles in URD and related-cable marking
- 10 mil polyester tags flex and conform easily to cable of any size
- Clear self-laminating overlay protects written information from water
- Standard package: 25 tags & cable ties

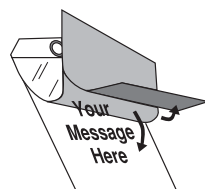

Size	Colors					
	White	Yellow	Blue	Green	Orange	Red
2" x 3"	101991	101992	101995	101994	101996	101993
2.5" x 4"	102015	-	-	-	-	-
3" x 1.5"	101973	101974	101977	101976	101978	101975
3" x 3"	102003	102004	102007	102006	102008	102005
4" x 2"	101997	101998	102001	102000	102002	101999
5" x 1.5"	101979	101980	101983	101982	101984	101981
5" x 2.5"	102016	102017	102020	102019	102021	102018
5" x 3.25"	102009	102010	102013	102012	102014	102011



## Color-Coded Plasti-Tags

- Smooth write-on surface
- Rigid 10 mil blank tags with nylon ties
- Available in both square and round varieties

Catalog #	Size	Color	Qty.
56927	2-1/5" x 3-1/2"	White	25/pk
56932	3" Round	White	25/pk
56926	2-1/5" x 3-1/2"	Yellow	25/pk
56931	3" Round	Yellow	25/pk
56928	2-1/5" x 3-1/2"	Blue	25/pk
56933	3" Round	Blue	25/pk
56929	2-1/5" x 3-1/2"	Green	25/pk
56934	3" Round	Green	25/pk
56930	2-1/5" x 3-1/2"	Red	25/pk
56935	3" Round	Red	25/pk



## Color-Coded Lock-On Tags

- Long-lasting plastic tags lock onto itself
- Resists moisture, grease and dirt

Catalog #	Size	Color	Qty.
30680	5-4/5" x 3-1/4"	White	25/pk
30684	5-4/5" x 3-1/4"	Yellow	25/pk
30682	5-4/5" x 3-1/4"	Blue	25/pk
30683	5-4/5" x 3-1/4"	Green	25/pk
30681	5-4/5" x 3-1/4"	Red	25/pk

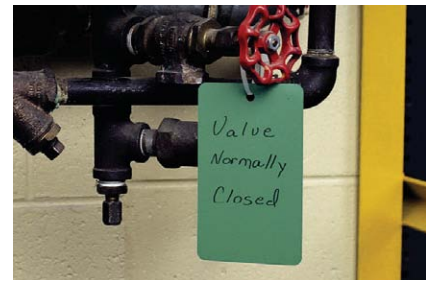

## Metal Write-On Tags

- Durable metal accepts most marking pens and includes nylon tie
- Metal can be bent and straightened without cracking

Catalog #	Size	Color	Qty.
56937	5" x 3"	White	1 ea
56936	5" x 3"	Yellow	1 ea
56938	5" x 3"	Blue	1 ea
56939	5" x 3"	Green	1 ea
56940	5" x 3"	Red	1 ea

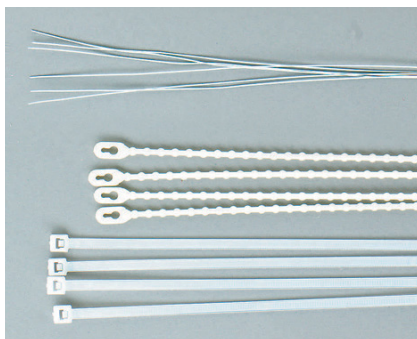

## Tag Fasteners

- Three fastener styles available to meet every application
- Nylon fasteners meet OSHA requirements for attaching tagout devices

Catalog #	Description	Qty.
81760	12" 26 Gauge Wire	100
81761	8" Reusable Beaded Ties	100
81762	8" Nylon Fasteners	100



## Protective Envelopes

- Transparent, durable vinyl construction
- Ideal for indoor or outdoor use
- Protects tags and cards on machinery, valves, switches, controls, and more
- Available with a variety of closure and mounting features

Catalog #	Description	Size	Qty.
81769	Magnetic Backed	4.5" x 6.5"	10
81770	Magnetic Backed	5.5" x 8.5"	10
81771	Adhesive Backed	4.5" x 6.5"	10
81772	Adhesive Backed	5.5" x 8.5"	10
81765	Zip-lock w/o Grommet	4.5" x 6.5"	10
81767	Zip-lock w/o Grommet	5.5" x 8.5"	10
81766	Zip-lock w/ Grommet	4.5" x 6.5"	10
81768	Zip-lock w/ Grommet	5.5" x 8.5"	10
81763	Open-Ended	4.5" x 6.5"	10
81764	Open-Ended	5.5" x 8.5"	10



## Fluorescent Protective Envelopes

- Transparent, durable vinyl construction
- Fluorescent edging is ideal for color-coding work in process, machine procedures and drawings

Catalog #	Size	Color	Qty.
56941	9" x 9"	Fluorescent Green	25
56945	9" x 12"	Fluorescent Green	25
56942	9" x 9"	Fluorescent Orange	25
56946	9" x 12"	Fluorescent Orange	25
56944	9" x 9"	Fluorescent Yellow	25
56948	9" x 12"	Fluorescent Yellow	25



# Scaffolding Tags

BradyID.com/s34

## Scafftag® Scaffolding Tags

- 5-3/4" x 3" tags feature two chamfered corners and a 3/8" grommeted hole
- Available in a variety of materials:
  - B-837 - Heavy Duty Laminated Polyester (10/pack with nylon fasteners)
  - B-851 - Economy Polyester (10/pack with nylon fasteners)
  - B-853 - Cardstock (100/pack with string fasteners)



86452	5-3/4" x 3"	B-837	10/pk	86453	5-3/4" x 3"	B-837	10/pk	86454	5-3/4" x 3"	B-837	10/pk
89017	7" x 4"	B-837	10/pk	89018	7" x 4"	B-837	10/pk	86502	7" x 4"	B-837	10/pk
86572	5-3/4" x 3"	B-851	10/pk	86573	5-3/4" x 3"	B-851	10/pk	86574	5-3/4" x 3"	B-851	10/pk
86627	7" x 4"	B-851	10/pk	86628	7" x 4"	B-851	10/pk	86629	7" x 4"	B-851	10/pk
86682	5-3/4" x 3"	B-853	100/pk	86683	5-3/4" x 3"	B-853	100/pk	86684	5-3/4" x 3"	B-853	100/pk
86737	7" x 4"	B-853	100/pk	86738	7" x 4"	B-853	100/pk	86739	7" x 4"	B-853	100/pk



## Scaffolding Tag Holder

- 0.060" thick plastic tag holder with clear front pocket
- 12" x 4-1/2" holder accommodates tags with a size of 5-3/4" x 3"

Catalog #	Description
48111	Holder Only
48112	Holder Kit (holder + 3 tags)



## Scafftag® Scaffolding Tags

- Provides system, procedural and legal compliance for scaffolds on worksites
- Provides a clear inspection trail giving integrity and control of work carried out
- Essential for companies working with ISO9000 clients

Catalog #	Description	Size	Color	Qty.
SCAF-STH132	Holders	11-3/4" x 3-1/2"	White	10/box
SCAF-STH146	Holders	11-3/4" x 3-1/2"	Red	10/box
SCAF-STSI593	Inspection Inserts	3-1/4" x 7-5/8"	Green	100/pkg
SCAF-STSI594	Caution Inserts	3-1/4" x 7-5/8"	Yellow	100/pkg
SCAF-STH132A	Standard Kit*	-	White	1 kit
SCAF2-STHUSA	Scafftag II Holder	11-1/2" x 6"	White	10/box
SCAF-STSI751	Inspection Inserts	5-3/4" x 7-5/8"	Green	100/pkg
SCAF2-STHUSAA	Scafftag II Kit*	-	White	1 kit

\*Kits include 10 Holders, 20 Inserts and 1 Pen

## LadderTags™ Holder and Inserts

LADDERTAG™ is a complete ladder safety management system. Regulations require ladders to be checked for damage, faults and wear before use by an authorized user, and may assist with the requirements of CFR 1926.1053 (a) (12), (b) (17) (i) (ii) and CFR 1910.25 (d) (1) (X)

Catalog #	Description	Size	Color	Qty.
LAD-EITH12	Holders	2-1/4" x 8-1/4"	White	10/box
LAD-EITL521	Inserts	2" x 6-1/2"	Yellow	100/pkg
LAD-EITH/L12	Kit*	-	White	1 kit

\*Kit includes 10 holders, 10 inserts and 1 pen

# Inspection Tagging Systems

BradyID.com/s34



## Micro Tag Holder and Inserts

A safety system which is particularly useful for identifying small plant, equipment, lifting gear and safety harnesses. Color coded and date qualified, the system also has the facility to render equipment in a 'prohibition status' should it be found to be faulty between inspection dates. Meets the requirements for OSHA CFR 1926.502 (d) (21) Personal Fall Arrest systems.

Catalog #	Description	Size	Color	Qty.
MIC-MTIGPI G	Next Inspection Date Due	1-7/8" x 1-1/4"	Green	100
MIC-MTIGPI R	Next Inspection Date Due	1-7/8" x 1-1/4"	Red	100
MIC-MTIGPI Y	Next Inspection Date Due	1-7/8" x 1-1/4"	Yellow	100
MIC-MTHSTD04	Microtag Kit*			1

\*Kit includes 20 holders, 40 cables ties and 1 pen



## Forklift™ Holder and Inserts

Assists with the requirements of 1910.178 (q) (7) pre-use preventative maintenance and safety inspection for forklift trucks. The FORKLIFT™ holder is permanently attached to the cage of the forklift truck and displays the prohibition sign and the script "DO NOT USE". The FORKLIFT™ insert shows in written and graphic format the daily or pre-shift, inspections be carried out by the first user.

Catalog #	Description	Size	Color	Qty.
FLT-ETSH9	Forklift Holder	11-1/2" x 6"	White	10
FLT-ETSI51	Forklift Inserts	5-3/4" x 7-5/8"	Blue/Yellow	100
FLT-ETSH9A	Forklift Kit*			1

\*Kit includes 10 holders, 10 status inserts and 1 pen



## MultiTag® Holder and Inserts

Assists with the identification and preventative maintenance requirements of a range of equipment, and may assist with the requirements of CFR 1926.1053 (a) (12), (b) (17) (i) (ii) and CFR 1910.25 (d) (1) (X). US Patent # 314,016

Catalog #	Description	Size	Color	Qty.
MUL-EITHUSA01	Multitag Holder	2-1/4" x 8-1/4"	White	10
MUL-EITL535	Multitag Inserts	2" x 6-1/2"	Green	100
MUL-EITHUSA01A	Multitag Kit			1

\*Kit includes 10 holders, 10 inserts and 1 pen



## EntryTag® Holder and Inserts

Works in conjunction with existing permit to work systems and assist with the requirements of CFR 1910.146 (c) (2), (d) (11) and (f) (2). ENTRYTAG® is a visual reminder to authorized personnel and assists in instructing non authorized personnel of the critical requirements contained within the permit to work. The system clearly states the minimum requirements of entry to the confined space or whether the area is in prohibition and cannot be entered.

Catalog #	Description	Size	Color	Qty.
ENT-ETSH157	Entrytag Holder	11-1/4" x 6"	White	10
ENT-ETS1532	Standard Inserts	5-3/4" x 7-5/8"	Green	100
MUL-EITL 230	Man In Tank Tag	2" x 6-1/2"	Yellow	100
ENT-ETSH157A	Entry Tag Kit*			1

\*Kit includes 10 holders, 20 status inserts and 1 pen



# Valve Tags

BradyID.com/s34

## Valve Identification

Valve tags help relay important pipe content information, valve identification or operation information at the point of need. Some stock valve tag options, like our brass valve tags and energy source tags, are available with preset legends. All of our tags are available for customization or as blanks so you may stamp or print your own tag text or legends.



### ASME A13.1

Recommends the use of a permanently legible tag for identification of materials in pipes less than 3/4" (19mm) in diameter.

## Valve Tag Material Descriptions

Characteristic	HIGH PERFORMANCE				GENERAL PURPOSE					
	HEET Tag B-748	Teflon B-541	Fiberglass B-120	Plastic Tag B-418	Brass B-907	Aluminum B-906	Stainless Steel B-919	3-Ply Engraved B-1	Polyester B-851	Polyurethane B-462
<b>Plant Environment</b>										
Indoor	Good	Good	Good	Good	Good	Good	Good	Good	Good	Good
Avg. Outdoor Durability (yrs)	5-7	Up to 10	15	5-7**	3-6	Up to 2	5-7	5-8	3-5	5-7
Surface Abrasion Resistance	Good	Good	Good	Good	Good	Good	Good	Good	Fair	Good
<b>Temperatures</b>										
Upper Limit	248°F (120°)	500°F (260°C)	193°F (89°C)	260°F (127°C)	233°F (113°C)	233°F (113°C)	1500°F (815°C)	193°F (89°C)	212°F (100°C)	250°F (121°C)
Lower Limit	-40°F (40°C)	-40°F (40°C)	-40°F (40°C)	-40°F (40°C)	-40°F (40°C)	-40°F (40°C)	-40°F (40°C)	-40°F (40°C)	-40°F (40°C)	-40°F (40°C)
<b>Chemical Resistance</b>										
Organic Solvents (MEK, Acetone, Toluene)	Not Rec.	Good	Not Rec.	Not Rec.	Not Rec.	Not Rec.	Good	Not Rec.	Not Rec.	Not Rec.
Acids (Sulfuric, HCl, Acetic)	Good	Not Rec.	Not Rec.	Good	Not Rec.	Not Rec.	Not Rec.	Not Rec.	Good	Good
Alkali (Sodium Hydroxide)	Not Rec.	Not Rec.	Not Rec.	Good	Not Rec.	Not Rec.	Not Rec.	Good	Good	Good
Alcohols (Methanol, Isopropanol)	Not Rec.	Good	Good	Good	Good	Not Rec.	Good	Good	Good	Good
Grease/Oils (SAE 20, ASTM#3)	Good	Good	Good	Good	Good	Good	Good	Good	Good	Good
<b>Special Properties</b>										
Bar Coding Available	Yes	Yes	No	Yes	No	No	No	No	Yes	No
Protective Covering Available	Yes	No	No	Yes	No	No	No	No	Yes	No

\*\* Includes Tedlar Overlaminate Not Rec. = Not Recommended





## Custom Valve Tags

Brady offers a wide variety of customizable valve tags to meet your needs and the harsh environments through your facility. View the available tag types, then contact Brady Customer Service to order your custom tags today.



**Contact Brady Customer Service to order your custom tags today.**



### HEET Tags (B-748)

- Features overlaminated polyester which permanently bonds graphics to a stainless steel baseplate
- Custom text and graphics can all be included at no extra cost.
- Optional protective tag covers are available to assure readability even when covered with paint.
- Custom text one or both sides
- Sizes: 2"x2" or 2-1/2"x5"
- Available colors: yellow, red, green, blue or white



### Teflon Coated Aluminum Tags (B-541)

- Anodized aluminum printed with black text and coated with Teflon®; resisting corrosion, paint, chemicals and sunlight
- Legends, bar codes and human readable text available with variable print
- Fixed custom message, warning or logo may be added to all tags
- 1-1/2"x1-1/2" or 1"x3" Custom sizes are also available



### Fiberglass Tags (B-120)

- Graphics are embedded within a fiberglass/resin package in order to withstand moisture, grease, and dirt
- Standard colors are yellow and white
- Ability to add barcodes and multiple lines
- 2"x2" or 4"x4" Custom sizes and colors available



### Durable Rigid Plastic Tags (B-418)

- Colorful Plastic Tag has recessed area on both sides to apply printed label.
- Non-corrosive, lightweight, non-conductive and impact resistant
- Two sizes available: 1-1/2" x 3" or 2-1/2" x 4" label area
- Overlaminated choices include standard or UV resistant for durability
- Tags can be purchased individually
- Available colors: black, yellow, red, blue, green, orange, white, grey, brown & tan



### Stamped and Engraved Brass Tags (B-907)

- 19 gauge cartridge brass (40 mils thick) for general purpose valve identification.
- Available in 1-1/2" and 2" round, square, triangle, octagon/hexagon shapes.
- Available colors (natural or black-filled). All tags are produced Natural unless specifically requested. Black-filled legend is recommended for maximum legibility.
- Stamping or engraving options available



### Stamped and Engraved Aluminum Tags (B-906)

- Durable 19 gauge aluminum tags
- Type 3003-H14 material has been anodized, dyed, and sealed.
- Available in round or square shapes in either 1-1/2" or 2" sizes.
- Available colors (natural or black-filled). All tags are produced Natural unless specifically requested. Black-filled legend is recommended for maximum legibility.
- Stamping, engraving or etching options available



# Custom Valve Tags

BradyID.com/s34

## Custom Valve Tags (continued)



### STAINLESS STEEL (B-919)

- Durable .025" stainless steel tags.
- Pre-stamped tags may be black filled for easier readability.
- Equipment tags (which may include a bar code) are surface coated with ink and then engraved.
- Available in round or square shapes in either 1-1/2" or 2" sizes.
- Withstands temperatures of 2700° F
- Stamping, engraving or etching options available



01-43400-003  
HIGH STAGE COMPRESSOR NO. 3

10-631-220B  
FUME BLOWER

### 3-PLY ENGRAVED (B-1)

- A 1/16" rigid laminate plastic is heat resistant, non-conductive, non-corroding.
- Tag text engraved through a colored cap sheet to a contrasting colored base sheet
- Multiple background colors available
- Round sizes: 1-1/2" or 2"
- Square sizes: 0.75"x2.5", 1"x2.5", 1"x3", 2"x3", 1.5"x4", 2"x4"
- Hole size: 3/16"



### POLYESTER (B-851)

- Grommets heavy duty polyester tags withstand moisture, grease and dirt.
- Rigid polyester surface exceeds OSHA 50 lb. pull out requirement
- Polyester tags withstand moisture, grease and dirt
- Standard colors include red, yellow, blue, green and white
- Ability to add barcodes and multiple lines



### Polyurethane Valve Tags (B-462)

- Chemical and oil resistant; ideal for harsh environments
- Made of multi-purpose polyurethane that is heat stamped with the numbering or lettering of your choice.



**Style 1:** Tag size 3/4" x 2-5/8".  
Four 1/2" Characters making 1 line of text.

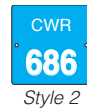

**Style 2:** Tag size 3" x 3".  
Five 1/2" Characters making 3 lines of text, or three 1" Characters making 2 lines



**Style 3:** Tag size 2-3/16" x 2".  
Four 1/2" Characters making in 1 line of text.



**Style 4:** Tag size 3" x 3-3/8".  
Five 1/2" Characters making 3 lines of text, or three 1" Characters 2 lines of text.



**Contact Brady Customer Service to order custom valve tags in any of the durable materials shown here.**

## Stamped Brass Valve Tags (B-907)

- 1-1/2" diameter stamped valve tags
- Constructed from 19 gauge cartridge brass (40 mils thick)
- Black filled text for easy readability
- 1/4" Top Legend, 1/2" Number Sequence
- Standard package: 25 tags (one each of sequence)

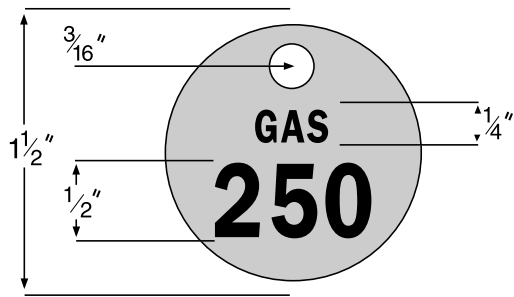

**Contact Brady Customer Service to customize these tags for your facility.**

Top Line Copy	1-25	26-50	51-75	76-100	101-125	126-150	151-175	176-200	201-225	226-250	251-275	276-300	301-325	326-350	351-375	376-400	401-425	426-450	451-475	476-500
(Blank)	23200	23201	23202	23203	23204	23205	23206	23207	23208	23209	23617	23618	23619	23620	23621	23622	23623	23624	23625	23626
AC	23272	23273	23274	23275	23480	23481	23482	23483	23484	23485	23486	23487	23488	23489	23490	23491	23492	23493	23494	23495
CA	87460	87461	87462	87463	87464	87465	87466	87467	87468	87469	87470	87471	87472	87473	87474	87475	87476	87477	87478	87479
CHW	23516	23517	23518	23519	23520	23521	23522	23523	23524	23525	23526	23527	23528	23529	23530	23531	23532	23533	23534	23535
CHWR	23596	23597	23598	23599	23600	23601	23602	23603	23604	23605	23606	23607	23608	23609	-	-	-	-	-	-
CHWS	23576	23577	23578	23579	23580	23581	23582	23583	23584	23585	23586	23587	23588	23589	-	-	-	-	-	-
COND	23647	23648	23649	23650	23651	23652	23653	23654	23655	23656	23657	23658	-	23660	23661	23662	23663	23664	23665	23666
CW	23256	23257	23258	23259	23400	23401	23402	23403	23404	23405	23406	23407	23408	23409	23410	23411	23412	23413	23414	23415
CWR	87100	87101	87102	87103	87104	87105	87106	87107	87108	87109	87110	87111	87112	87113	87114	87115	87116	87117	87118	87119
CWS	87120	87121	87122	87123	87124	87125	87126	87127	87128	87129	87130	87131	87132	87133	87134	87135	87136	87137	87138	87139
DCW	87200	87201	87202	87203	87204	87205	87206	87207	87208	87209	87300	87302	87303	87304	87305	87306	87307	87308	87309	87310
DCWR	87331	87332	87333	87334	87335	87336	87337	87338	87339	87340	87341	87342	87343	87344	87345	87346	87347	87348	87349	87350
DCWS	87371	87372	87373	87374	87375	87376	87377	87378	87379	87380	87381	87382	87383	87384	87385	87386	87387	87388	87389	87390
DHW	87180	87181	87182	87183	87184	87185	87186	87187	87188	87189	87190	87191	87192	87193	87194	87195	87196	87197	87198	87199
DHWR	87311	87312	87313	87314	87315	87316	87317	87318	87319	87320	87321	87322	87323	87324	87325	87326	87327	87328	87329	87330
DHWS	87351	87352	87353	87354	87355	87356	87357	87358	87359	87360	87361	87362	87363	87364	87365	87366	87367	87368	87369	87370
FP	23667	23668	23669	23670	23671	23672	23673	23674	23675	23676	23677	23678	23679	23680	-	23682	23683	23684	23685	23686
GAS	23264	23265	23266	23267	23448	23449	23450	23451	23452	23453	23454	23455	23456	23457	23458	23459	23460	23461	23462	23463
HPS	44720	44721	44722	44723	44724	44725	44726	44727	44728	44729	44730	-	44732	44733	44734	44735	44736	44737	44738	44739
HTG	23268	23269	23270	23271	23464	23465	23466	23467	23468	23469	23470	23471	23472	23473	23474	23475	23476	23477	23478	23479
HW	23276	23277	23278	23279	23416	23417	23418	23419	23420	23421	23422	23423	23424	23425	23426	23427	23428	23429	23430	23431
HWR	23536	23537	23538	23539	23540	23541	23542	23543	23544	23545	23546	23547	23548	23549	23550	23551	23552	23553	23554	23555
HWS	23556	23557	23558	23559	23560	23561	23562	23563	23564	23565	23566	23567	23568	23569	23570	23571	23572	23573	23574	23575
HVAC	87140	87141	87142	87143	87144	87145	87146	87147	87148	87149	87150	87151	87152	87153	87154	87155	87156	87157	87158	87159
LPC	87390	87391	87392	87393	87394	87395	87396	87397	87398	87399	87400	87401	87402	87403	87404	87405	87406	87407	87408	87409
LPS	44740	44741	44742	44743	44744	44745	44746	44747	44748	44749	44750	44751	44752	44753	-	44755	44756	44757	44758	44759
MPS	-	-	44702	44703	44704	44705	44706	44707	44708	44709	44710	44711	44712	44713	44714	44715	44716	44717	44718	44719
OXY	87480	87481	87482	87483	87484	87485	87486	87487	87488	87489	87490	87491	87492	87493	87494	87495	87496	87497	87498	87499
PLBG	23260	23261	23262	23263	23432	23433	23434	23435	23436	23437	23438	23439	23440	23441	23442	23443	23444	23445	23446	23447
SPK	-	-	-	23630	23631	23632	23633	23634	23635	23636	23637	23638	23639	23640	23641	23642	23643	23644	23645	23646
SPR	87160	87161	87162	87163	87164	87165	87166	87167	87168	87169	87170	87171	87172	87173	87174	87175	87176	87177	87178	87179
STM	23496	23497	23498	23499	23500	23501	23502	23503	23504	23505	23506	23507	23508	23509	23510	23511	23512	23513	23514	23515
VAC	87500	87501	87502	87503	87504	87505	87506	87507	87508	87509	87510	87511	87512	87513	87514	87515	87516	87517	87518	87519



# Blank Valve Tags

BradyID.com/s34

Valve Tags



## Blank Brass Valve Tags

- Standard package: 25 identical tags
- Customize your own brass tags with Brady steel stamps

Catalog #	Description
23210	1-1/2" Round Brass Tag
23211	2" Round Brass Tag
23212	1-1/2" Square Brass Tag
23213	2" Square Brass Tag



## Blank Aluminum Tags

- Anodized aluminum B-906 is dyed to offer color-coding options not available with brass tags
- Choose from 1-1/2" or 2" round styles
- Standard package: 25 tags

Catalog #	2" Round	2" Square	1-1/2" Round	1-1/2" Square
Black	87612	87637	87605	87619
Blue	49907	87641	49902	87629
Gold	87608	87633	87601	87615
Green	49908	87642	49903	87630
Light Blue	87613	87638	87606	87620
Natural	49909	87643	49904	87631
Olive Drab	87609	87634	87602	87616
Orange	87611	87636	87604	87618
Pink	87610	87635	87603	87617
Red	49906	87640	49901	87628
Violet	87607	87632	87600	87614
Yellow	49905	87639	49900	87627



## Blank Stainless Steel Tags

- B-919 tags are ideal for harsh environments or where a stainless steel material is specified
- Tag hole is 3/16"

Catalog #	Size	Qty.
44400	1-1/2" Round	25
44401	1-1/2" Square	25
44402	2" Round	25
44403	2" Square	25



## Durable Plastic Tags

- B-418 durable plastic tags are lightweight, non-corrosive, non-conductive and impact resistant
- Withstands temps -40°F to 260°F
- Standard package: 1 each with rounded corners and hole punched

Catalog #	3" x 1-1/2"	4" x 2-1/2"
White	87696	87697
Orange	87694	87695
Red	41924	41925
Yellow	41922	41923
Black	41920	41921
Blue	41926	41927
Brown	87710	87711
Tan	87712	87713
Grey	87698	87699
Green	41928	41929
Variety Pack	142133	

\* Variety Pack combines 30 tags including at least one of each size and color. Perfect for evaluating which sizes and colors you need.



## May We Also Suggest?

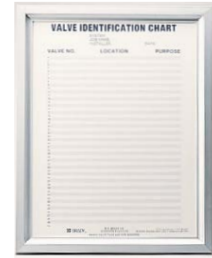

## Valve Chart Frame

- Aluminum frame with plastic window displays your valve 8"x11" tag chart
- Chart lists up to 50 locations

Catalog #	Description
23309	Valve Chart Frame



## Energy Source Tags

View on page 458

Energy source tags mark your facility's points of control for energy sources - making lockout processes quicker, safer and easier.



## Print Your Own Tags

View on page 352

Print custom labels with your BBP®31 Printer and attach them to blank tags show here.



Contact Brady Customer Service to customize tags for your facility.



## “S” Hooks

- Standard package: 100 “S” Hooks, sold in full packages only

Catalog #	Description	For Valve Stems Up To	Qty.
23305	1-3/4" O.D. Brass	1/2"	100
23304	1-1/2" O.D. Brass	3/8"	100
23303	1-1/4" O.D. Brass	1/4"	100
98862	1-1/4" O.D. Steel	1/4"	100



## #16 Jack Chain

- Approximately 25 links per foot
- Standard package: 50 feet of chain, sold in full packages only

Catalog #	Description	Qty.
23308	Brass #16	50' of chain
98859	Stainless Steel	50' of chain



## 4-1/2" Beaded Chain

- Extremely flexible 4-1/2" bead chain with locking link
- Standard package contains 100 chains, sold in full packages only

Catalog #	Description	Qty.
23306	4-1/2" #6 Brass chain	100
23307	4-1/2" #6 Nickel Plate chain	100
98856	4-1/2" #6 Aluminum chain	100
98857	4-1/2" #6 Stainless Steel chain	100

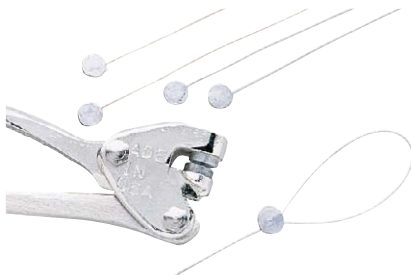

## Lead Seals

- 12" wires with pre-fitted lead seals fit easily around pipes or valves
- Seals and Hand Sealing Press sold separately

Catalog #	Description	Qty.
23301	Copper Lead Seals	250
23302	Monel Seals	250
23300	Hand Sealing Press	1



## Stainless Wire, Clamps and Cutting Tool

- Stranded stainless steel wire offers a secure attachment when used with Brady's Zinc Clamps
- Clamps feature double ferrule design

Catalog #	Description	Qty.
38090	Zinc Wire Clamps	50
38091	Stainless Steel Wire (48 mil)	30'
38088	Stainless Steel Wire Cutter	1



## Fastening Devices

- 32 mil stainless steel safety wire to be used with wire twister pliers.

Catalog #	Outside Dia.	Length
15424	Stainless Steel Safety Wire	1800 ft



Zinc Planted Temporary Ring

Nickel Key/Tag Ring

## Tag/Key Rings

- Temporary fastener for valve tags
- Squeeze fastener to open and close  
Inside diameter of fastener is 1-3/8"

Catalog #	Description	Qty.
58973	Nickel Key Ring	10
98858	Zinc Planted Temp Ring	100



## Quik-ApPLY™ Nylon Straps

- Standard fastener for Quik-ApPLY™ pipe marker sizes Q1-Q4
- Used with a variety of tags

Catalog #	Outside Dia.	Strap Length
91165	1"	6"
91166	2"	7"



## Colored Nylon Ties

- 8" nylon ties provide easy fastening of valve tags
- Hook ties together to create extra length

Catalog #	Description	Length	Qty.
98848	Black	8"	100
98849	Blue	8"	100
98850	Green	8"	100
98851	Natural	8"	100
98853	Purple	8"	100
98854	Red	8"	100
98855	Yellow	8"	100

# Pipe Identification Guide

BradyID.com/s34

## ASME (ANSI) Standard A13.1-2007

The ASME (ANSI) Standard for pipe identification is a widely used guideline in determining pipe identification requirements. The purpose of the standard is to:

- “assist in identification of hazardous materials conveyed in piping systems and their hazards when released into the environment.”
- “Pipes are defined as conduits for the transport of gases, liquids, semi-liquids or fine particulate dust.”



### Text Standards:

#### ASME (ANSI) Size Recommendations

The legend (name of pipe content) and directional flow arrow is the primary means of identifying pipe content. A13.1-2007 standard makes recommendations as to the size of letter height and length of color field for various pipe diameters.

Outside Diameter of Pipe or Covering	Length of Color Field	Size of Letters
3/4" to 1-1/4"	5"	1/2"
1-1/2" to 2"	8"	3/4"
2-1/2" to 6"	12"	1-1/4"
8" to 10"	24"	2-1/2"
Over 10"	32"	3-1/2"

\* For pipes less than 3/4" dia. use a permanently legible tag.

### Color Standards:

#### ASME (ANSI) Color Recommendations

Unmarked pipes mean danger – to both life and property. Numerous injuries have occurred through ignorance of pipe contents, particularly when outside agencies are called in under emergency conditions.

Pipe Classification	Color Scheme
Fire Quenching Fluids	White On Red
Toxic & Corrosive Fluids	Black On Orange
Flammable Fluids	Black On Yellow
Combustible Fluids	White On Brown
Potable, Cooling, Boiler Feed, and Other Water	White On Green
Compressed Air	White On Blue

\*White on brown available upon request.

### Marker Placement Standards:

#### ASME (ANSI) A13.1-2007 Standard

Visibility “Markers shall be located so that they are readily visible to plant personnel from the point of normal approach.” Brady Pipe Markers instantly tell you all you need to know about pipe contents, direction of flow and whether hazardous or safe.

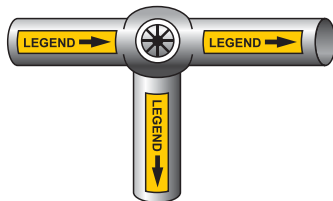

Adjacent to all valves and flanges.

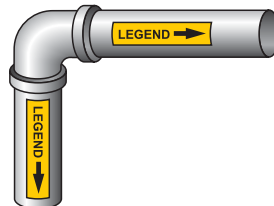

Adjacent to changes in direction.

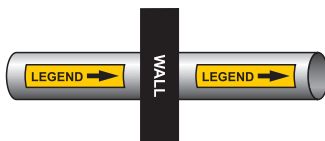

At both sides of floor or wall penetrations.

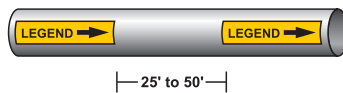

Every 25' to 50' intervals on straight runs.

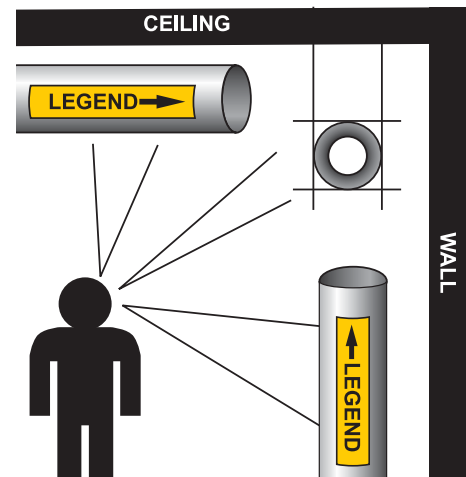

Placement of the marker may be above or below the centerline of the pipe depending on the normal approach of personnel.

## Pipe Marker Material Descriptions

Characteristic	HARSH ENVIRONMENT Mechanically Applied		General Purpose		
	B-689 Wrap-Around Polyester	B-681/B-883 High Performance High Visibility	B-915 BradySnap-On™ and Strap-On Vinyl	B-946 Self-Sticking Vinyl	B-736 Self-Sticking Plastic Film
<b>Plant Environment</b>					
Indoor	Good	Good	Good	Good	Good
Avg. Outdoor Durability (yrs.)	5-8 years	5-8 years	5-8 years	3-5 years	2-3 years
Surface Abrasion Resistance	Good	Good	Not Recommended	Not Recommended	Not Recommended
<b>Temperatures</b>					
Min. Installation Temperature	40°F, 5°C	—	—	0°F, -18°C	50°F, 10°C
Upper Temperature Limit	248°F, 120°C	230°F, 110°C	180°F, 82°C	180°F, 82°C	212°F, 100°C
Lower Temperature Limit	-40°F, -40°C	-40°F, -40°C	-40°F, -40°C	-40°F, -40°C	-40°F, -40°C
<b>Pipe Surface</b>					
Dirty, Dusty	Good	Good	Good	Not Recommended	Not Recommended
Rough	Good	Good	Good	Good	Not Recommended
Insulated	Good	Good	Good	Good	Good
Wet	Good	Good	Good	Not Recommended	Not Recommended
Greasy, Oily	Good	Good	Good	Not Recommended	Not Recommended
<b>Chemical Resistance</b>					
Organic Solvents (MEK, Acetone, Toluene)	Not Recommended	Not Recommended	Not Recommended	Not Recommended	Not Recommended
Acids (Sulfuric, HCL, Acetic)	Good	Good	Not Recommended	Not Recommended	Good
Alkalis (Sodium Hydroxide)	Good	Good	Not Recommended	Not Recommended	Not Recommended
Alcohols (Methanol, Isopropanol)	Good	Good	Good	Good	Good
Grease/Oils (SAE 20, ASTM #3)	Good	Good	Good	Good	Good
<b>Special Properties</b>					
Low PVC - Pipe contact point	Yes	Yes	No	No	No
Low PVC - Whole marker	No	Yes	No	No	No
Low Halogen - Pipe contact point	Yes	Yes	No	No	No
Low Halogen - Whole marker	No	Yes	No	No	No
Meets ASME (ANSI) A13.1	Yes	Yes	Yes	Yes	Yes

Not Recommended = marker not recommended for environment listed    Good = marker suitable for environment listed

### Self-Sticking Pipe Markers



#### Self-Sticking Vinyl Pipe Markers

Factory applied industrial grade adhesives simplify marker installation. Simply peel the release coated paper backing from the marker and press the marker in place. Banding each end of the marker with Arrow Tape is recommended to indicate contents flow direction and to secure markers to the pipe.

- **B-946 Self-Sticking Vinyl**  
A premium indoor/outdoor material
- **B-681 Food & Beverage**  
Industrial grade self-adhesive protects against bacteria or moisture trapping behind the pipe marker.
- **B-736 Pipe Markers-To-Go**  
Economical B-736 material with surface printed plastic for use on smooth, clean, dry pipe surfaces

### Mechanically Applied Pipe Markers



#### BradySnap-On™ and Strap-On Vinyl

Unlike installing self-sticking markers, there's no need to clean pipe surfaces. Installation time is reduced. Markers are simply snapped, strapped or wrapped in place.

- **B-915 BradySnap-On™ and Strap-On Vinyl**  
A mechanically applied, surface printed vinyl pipe marker. Snap-ons are used for pipes less than 6" outside diameter. Strap-ons are designed for pipes from 6" and greater



#### High Performance Pipe Markers

Brady High Performance Markers are designed for use in harsh environments where there's significant exposure to sunlight, heat, and/or chemicals.

- **B-689 High Performance Polyester**  
PVF overlaminated polyester with sealed-in graphics. Markers are resistant to abrasion, chemicals, high humidity, and outdoor weathering. Supplied precooled for easy wrap-around installation on pipes up to 7-7/8" in diameter
- **B-681/B-883 High Performance High Visibility**  
B-681 labels are factory applied to our B-883 FRP carrier. Directional arrows are applied by the installer. Markers are fastened to the pipe with Stainless Steel Strapping, sold separately



# IIAR Pipe Markers

BradyID.com/s34



## Did You Know? IIAR Pipe Markers - Ammonia Refrigeration Pipe Markers

The International Institute of Ammonia Refrigeration (IIAR) standardized ammonia pipe labeling when it published its bulletin #114, "Guidelines for Identification of Ammonia Refrigeration Piping and System Components."

Brady offers a variety of ammonia pipe markers that comply with the IIAR's established guidelines, including self-adhesive markers, snap-around marker styles, and pipe markers recommended for harsh environments (both indoors and outside).

IIAR Pipe Marker should have the following sections:



### Directional Arrows

Use arrow tape to indicate flow direction

### Ammonia Piping Abbreviation

\*See below

### Physical State

the physical state of the refrigerant located to the left of "Ammonia":

**If Liquid** – "LIQ"  
black or white on orange background

**If Vapor** – "VAP"  
black or white on sky blue background

**If Both** – "LIQ" "VAP"  
both printed in colors above

### Marker Body

"Ammonia" - black letters on yellow background

### Pressure Level

the pressure level of the refrigerant located to the right of "Ammonia":

**If High** – "HIGH"  
black or white on red background

**If Low** – "LOW"  
black or white on green background

**If Both** – "LIQ" "VAP"  
both printed in colors above

### Directional Arrows

Use arrow tape to indicate flow direction

### Ammonia Piping Abbreviations:

Abbr.	System
BD	Booster Discharge
CD	Condenser
DC	Defrost Condensate
EQ*	Equalizer
ES	Economizer Suction
HGD	Hot Gas Defrost
HPL	High Pressure Liquid
HSD	High Stage Discharge
HSS	High Stage Suction
HTS*	High Temperature Suction
HTRL	High Temperature Recirculated Liquid
HTRS	High Temperature Recirculated Suction
LTRL	Low Temperature Recirculated Liquid
LTS*	Low Temperature Suction
LTRS	Low Temperature Recirculated Suction
LIC	Liquid Injection Cooling
LSS	Low Stage Suction
PO*	Pump Out
PU*	Purge
RV	Relief Vent
TSR	Thermosyphon Return
TSS	Thermosyphon Supply

\*Not currently covered in the IIAR standard







## IIAR Pipe Markers

- Meets IIAR Standard and is recommended for use in labeling ammonia piping and its contents
- Choose the material that best meets your application requirements: High Performance Polyester or Indoor/Outdoor Self-Sticking Vinyl
- Create custom IIAR Pipe Markers on the spot utilizing the GlobalMark™ Industrial Labeling System (sold separately)



Example of B-689 High Performance Pipe Markers



Example of B-681/B883 HPHV Pipe Markers



Example of B-946 Self-Sticking Vinyl Pipe Markers

### IIAR B-689 High Performance Wrap-Around Pipe Markers Style and Size Chart

Style Code	Outside Dia.	Letter Height	Max Char.
Style: I	1-1/2" to 2-3/8"	3/4"	13
Style: II	2-1/2" to 7-7/8"	1-1/4"	13

### IIAR B-681/B883 HPHV Pipe Markers Style and Size Chart

Style Code	Outside Dia.	Letter Height	Max Char.
Style: HPHV	8" or larger	3-1/2"	16

### B-946 Self-Sticking Vinyl Pipe Markers Style and Size Chart

Style Code	Outside Diameter	Letter Height	Style Description	Style Example
Style: 1	2-1/2" to 7-7/8"	2"	One 2-1/4" x 14" marker per card	
Style: 1HV	8" or greater	3-1/2"	One 4" x 24" marker per card	
Style: 3C	less than 34"	1/2"	Three 2-1/4" x 2-3/4" markers per card plus 8 strips of Arrow Tape	
Style: 4	34" to 2-38"	34"	Four 1-1/8" x 7" markers per card	

## IIAR Pipe Markers

IIAR Abbr.	Physical State	Pressure Level	Legend	B-689 Wrap-Around		B-681/B-883	B-946 Self-Sticking Vinyl		
				Style I	Style II	Style HPHV	Style 1HV	Style 1	Style 4
BD	VAP	LOW	Ammonia	57960	57980	59919	90440	90400	90420
CD	LIQ	HIGH	Ammonia	57961	57981	59920	90441	90401	90421
DC	LIQ	HIGH	Ammonia	57962	57982	59921	90442	90402	90422
ES	VAP	LOW	Ammonia	57963	57983	59922	90443	90403	90423
EQ	LIQ/VAP	LOW	Ammonia	58014	58017	59982	90486	90484	90485
HG	VAP	HIGH	Ammonia	57964	57984	59923	90444	90404	90424
HGD	VAP	HIGH	Ammonia	57965	57985	59924	90445	90405	90425
HPL	LIQ	HIGH	Ammonia	57966	57986	59925	90446	90406	90426
HSD	VAP	HIGH	Ammonia	57967	57987	59926	90447	90407	90427
HSS	VAP	LOW	Ammonia	57968	57988	59927	90448	90408	90428
HTRL	LIQ	LOW	Ammonia	57969	57989	59928	90449	90409	90429
HTRS	LIQ/VAP	LOW	Ammonia	57970	57990	59929	90450	90410	90430
HTS	VAP	LOW	Ammonia	57971	57991	59930	90451	90411	90431
LIC	LIQ	HIGH	Ammonia	57972	57992	59931	90452	90412	90432
LSS	VAP	LOW	Ammonia	57973	57993	59932	90453	90413	90433
LTRL	LIQ	LOW	Ammonia	57974	57994	59933	90454	90414	90434
LTRS	LIQ/VAP	LOW	Ammonia	57975	57995	59934	90455	90415	90435
LTS	VAP	LOW	Ammonia	57976	57996	59935	90456	90416	90436
PO	LIQ	LOW	Ammonia	58012	58015	59980	90480	90478	90479
PU	LIQ	HIGH	Ammonia	58013	58016	59981	90483	90481	90482
RV	VAP	HIGH	Ammonia	57977	57997	59936	90457	90417	90437
TSR	LIQ/VAP	HIGH	Ammonia	57978	57998	59937	90458	90418	90438
TSS	LIQ	HIGH	Ammonia	57979	57999	59938	90459	90419	90439
BLANK	LIQ	HIGH	Ammonia	58000	58006	59939	90462	90460	90461
BLANK	VAP	HIGH	Ammonia	58001	58007	59940	90468	90466	90467
BLANK	LIQ/VAP	HIGH	Ammonia	58002	58008	59941	90474	90472	90473
BLANK	LIQ	LOW	Ammonia	58003	58009	59942	90465	90463	90464
BLANK	VAP	LOW	Ammonia	58004	58010	59943	90471	90469	90470
BLANK	LIQ/VAP	LOW	Ammonia	58005	58011	59944	90477	90475	90476



# Self-Sticking Pipe Markers

BradyID.com/s34



## Self-Sticking Vinyl Pipe Markers (B-946)

- Markers meet the requirements of the ASME (ANSI) A13.1 Standard for the identification of piping system contents when used with Directional Flow Arrow Tape
- Durable B-946 material ideal for indoor and outdoor environments
- Supplied on a coated backing material that makes handling and installation easy
- Recommended to use Directional Flow Arrow Tape to indicate flow direction

### How to order:

1. Choose the desired pipe marker legend below.
2. Replace the asterisk (\*) with the style code from the chart on the right (1, 1HV, 3C or 4) to indicate your desired pipe marker size and style. (Example: Air = 7005-3C)

### Style and Size Chart

Style Code	Outside Diameter	Letter Height	Style Description	Style Example
Style: 1	2-1/2" to 7-7/8"	2"	One 2-1/4" x 14" marker per card	<b>HEATING RETURN</b>
Style: 1HV	8" or greater	3-1/2"	One 4" x 24" marker per card	<b>HEATING RETURN</b>
Style: 3C	less than 34"	1/2"	Three 2-1/4" x 2-3/4" markers per card plus 8 strips of Arrow Tape	
Style: 4	34" to 2-38"	3/4"	Four 1-1/8" x 7" markers per card	<b>FIRE AUTO SPRINKLERS FIRE AUTO SPRINKLERS</b>

### Self-Sticking Pipe Marker Legends

Catalog Number	Legend	Bkgd Color
7021-*	(Blank)	Blue
7022-*	(Blank)	Green
7023-*	(Blank)	Orange
7024-*	(Blank)	Red
7025-*	(Blank)	Yellow
7026-*	(Blank)	White
7307-*	____ °C	Yellow
7308-*	____ °F	Yellow
7309-*	____ LB. STEAM	Yellow
7310-*	____ PSI	Yellow
7000-*	Acetone	Yellow
7001-*	Acetylene Gas	Yellow
7002-*	Acid	Yellow
7003-*	Acid Vent	Yellow
7004-*	Acid Waste	Yellow
7005-*	Air	Yellow
7006-*	Air	Blue
7007-*	Air	Green
7008-*	Air Return	Blue
7009-*	Air Return	White
7010-*	Air Supply	Blue
7011-*	Air Supply	White
7012-*	Alcohol	Yellow
7013-*	Alum	Yellow
7014-*	Ammonia	Yellow
7015-*	Argon	Green
7016-*	Argon	Blue
7017-*	Asbestos Free	Blue
7018-*	Asbestos Free Insulation	Blue
7019-*	Asbestos Insulation	Yellow
7020-*	Backwash	Green
8782-*	Black Liquor	Yellow
8783-*	Bleach Liquor	Yellow
7027-*	Blow Off Water	Yellow
7028-*	Blowdown	Yellow
7029-*	Blower Air	Green
7030-*	Boiler Blow Down	Yellow
7031-*	Boiler Feed	Yellow
7032-*	Boiler Feed	Green
7033-*	Boiler Feed Water	Yellow
7034-*	Boiler Water	Green
7035-*	Breathing Air	Green
7036-*	Brine	Green
7038-*	Carbon Dioxide	Yellow
7039-*	Carbon Dioxide	Red
7040-*	Caustic	Yellow
7041-*	Caustic Soda	Yellow
7042-*	Chemical	Yellow
7043-*	Chemical Feed	Yellow
7044-*	Chilled Hot Water	Green

Catalog Number	Legend	Bkgd Color
7045-*	Chilled Water	Green
7046-*	Chilled Water Return	Green
7047-*	Chilled Water Supply	Green
7048-*	Chlorine	Yellow
7049-*	Chlorine Gas	Yellow
7050-*	Chlorine Solution	Yellow
7051-*	Circulating Water	Green
7052-*	Circulating Water	Yellow
7053-*	City Gas	Yellow
7054-*	City Water	Green
7055-*	Cold Water	Green
7056-*	Cold Water Return	Green
7057-*	Cold Water Supply	Green
7058-*	Compressed Air	Yellow
7059-*	Compressed Air	Green
7060-*	Compressed Air	Blue
7061-*	Condensate	Yellow
7062-*	Condensate Drain	Yellow
7063-*	Condensate Drain	Green
7064-*	Condensate Pump Discharge	Yellow
7065-*	Condensate Return	Yellow
7066-*	Condensate Supply	Yellow
7067-*	Condenser Water	Green
7068-*	Condenser Water Return	Green
7069-*	Condenser Water Supply	Green
7070-*	Cooling Water	Green
7071-*	Cooling Water Return	Green
7072-*	Cooling Water Supply	Green
8784-*	Crude Oil	Yellow
7073-*	Deionized Water	Green
7074-*	Deionized Water Return	Green
7075-*	Deionized Water Supply	Green
7076-*	Digested Sludge	Yellow
7077-*	Digester Gas	Yellow
7078-*	Diesel Oil	Yellow
7079-*	Discharge	Yellow
7080-*	Discharge	Green
7081-*	Distilled Water	Green
7082-*	Domestic	Yellow
7083-*	Domestic	Green
7084-*	Domestic Cold Water	Green
7085-*	Domestic Cold Water Return	Green
7086-*	Domestic Cold Water Supply	Green
7087-*	Domestic Hot Water	Yellow
7088-*	Domestic Hot Water Return	Yellow
7089-*	Domestic Hot Water Supply	Yellow
7090-*	Drain	Green
7091-*	Drain	Yellow
7092-*	Drain Water	Green
7093-*	Drinking Water	Green
7094-*	Dual Temperature	Yellow

Catalog Number	Legend	Bkgd Color
8785-*	Dye	Yellow
7095-*	Effluent	Yellow
7096-*	Electric Traced	Yellow
7097-*	Electric Traced	Orange
8786-*	Engine Oil	Yellow
7098-*	Exhaust	Yellow
7099-*	Exhaust	Green
7100-*	Exhaust Air	Blue
7101-*	Exhaust Air	White
7102-*	Exhaust Intake	Blue
7103-*	Feed	Yellow
7104-*	Feed	Green
7105-*	Filtered Water	Green
7106-*	Filtrate	Yellow
7107-*	Fire Auto Sprinklers	Red
7108-*	Fire Dry Standpipe	Red
7109-*	Fire Main	Red
7110-*	Fire Protection Water	Red
7111-*	Floor Drain	Green
7112-*	Freon	Green
7113-*	Fresh Water	Green
7114-*	Fuel Gas	Yellow
7115-*	Fuel Oil	Yellow
7116-*	Fuel Oil Return	Yellow
7117-*	Fuel Oil Supply	Yellow
7118-*	Fuel Oil Vent	Yellow
7119-*	Gas	Yellow
7120-*	Gasoline	Yellow
7121-*	Glycol	Yellow
7122-*	Glycol Return	Yellow
7123-*	Glycol Supply	Yellow
8787-*	Green Liquor	Yellow
8788-*	Halon	Red
7124-*	Heating	Yellow
7125-*	Heating Return	Yellow
7126-*	Heating Steam	Yellow
7127-*	Heating Supply	Yellow
7128-*	Heating Water	Yellow
7129-*	Heating Water Return	Yellow
7130-*	Heating Water Supply	Yellow
7132-*	Helium	Green
7133-*	Helium	Blue
7134-*	High Pressure	Yellow
7135-*	High Pressure Air	Yellow
7136-*	High Pressure Air	Green
7137-*	High Pressure Condensate	Yellow
7138-*	High Pressure Gas	Yellow
7139-*	High Pressure Natural Gas	Yellow
7140-*	High Pressure Nitrogen	Yellow
7141-*	High Pressure Steam	Yellow
7142-*	High Pressure Water	Yellow

# Self-Sticking Pipe Markers

BradyID.com/s34

Catalog Number	Legend	Bkgd Color
7143*	High Temperature Hot Water	Yellow
7144*	Hot	Yellow
7145*	Hot Gas	Yellow
7146*	Hot Water	Yellow
7147*	Hot Water Recirculation	Yellow
7148*	Hot Water Return	Yellow
7149*	Hot Water Supply	Yellow
7150*	House Vacuum	Green
7151*	Hvac Return	Yellow
7152*	Hvac Supply	Yellow
8789*	Hydraulic Fluid	Yellow
7153*	Hydraulic Line	Yellow
8790*	Hydraulic Oil	Yellow
7154*	Hydraulic Return	Yellow
7155*	Hydraulic Supply	Yellow
7156*	Hydrochloric Acid	Yellow
7157*	Hydrogen	Yellow
7158*	Hydrogen Peroxide	Yellow
7159*	Hydrogen Sulfide	Yellow
7160*	Industrial Cold Water Return	Green
7161*	Industrial Hot Water	Yellow
7162*	Industrial Waste	Yellow
7163*	Industrial Water	Green
7164*	Inert Gas	Green
8791*	Inert Gas	Yellow
7165*	Inlet	Yellow
7166*	Instrument Air	Yellow
7167*	Instrument Air	Green
7168*	Instrument Air	Blue
7169*	Kerosene	Yellow
7170*	Lab Compressed Air	Blue
7171*	Lab Vacuum	Yellow
8792*	Lab Vent	Yellow
8793*	Lab Waste	Yellow
7172*	Liquid Nitrogen	Yellow
7173*	Low Pressure	Green
7174*	Low Pressure Air	Green
7175*	Low Pressure Condensate	Yellow
7176*	Low Pressure Gas	Yellow
7177*	Low Pressure Natural Gas	Yellow
7178*	Low Pressure Nitrogen	Yellow
7179*	Low Pressure Steam	Yellow
7180*	Low Pressure Water	Green
7181*	Lube Oil	Yellow
7182*	Make-Up Water	Green
7184*	Medical Air	Yellow
7186*	Medical Vacuum	White
7187*	Medium Pressure Air	Blue
7188*	Medium Pressure Condensate	Yellow
7189*	Medium Pressure Gas	Yellow
7190*	Medium Pressure Natural Gas	Yellow
7191*	Medium Pressure Steam	Yellow
7192*	Mill Air	Blue
7193*	Mill Water	Green
7194*	Mixed Gas	Yellow
7195*	Muriatic Acid	Yellow
8795*	Naphtha	Yellow
7196*	Natural Gas	Yellow
7197*	Nitric Acid	Yellow
7198*	Nitrogen	Green
7200*	Nitrogen	Blue

Catalog Number	Legend	Bkgd Color
7202*	Nitrous Oxide	Yellow
7203*	Non-Potable Water	Yellow
7204*	Oil	Yellow
7205*	Outlet	Green
7206*	Outside Air	Blue
7207*	Outside Air	White
7208*	Overflow	Yellow
7210*	Oxygen	Green
7209*	Oxygen	Yellow
7211*	Oxygen	Blue
8796*	Peroxide	Yellow
7212*	Plant Air	Yellow
7213*	Plant Water	Green
7214*	Plumbing Vent	Green
7215*	Polymer	Yellow
7216*	Polymer	White
7217*	Potable	Green
7218*	Potable Water	Yellow
7219*	Potable Water	Green
7220*	Primary	Yellow
7221*	Primary	Green
7222*	Primary Sludge	Brown
7223*	Process	Yellow
7224*	Process Water	Green
7225*	Processed Water	Yellow
7226*	Processed Water	Green
7227*	Propane Gas	Yellow
8797*	Pulp	Yellow
7228*	Pump	Yellow
8799*	Pumped Condensate	Yellow
7229*	Rain Water	Green
7230*	Raw Water	Green
7231*	Raw Water	Yellow
7232*	Recirculated	Yellow
7233*	Recovery	Yellow
8801*	Red Liquor	Yellow
7234*	Refrigerant Discharge	Yellow
7235*	Refrigerant Liquid	Yellow
7236*	Refrigerant Suction	Yellow
7237*	Refrigerated Water	Green
7238*	Refrigeration	Green
8802*	Reheat Water Return	Yellow
8803*	Reheat Water Supply	Yellow
7239*	Relief	Yellow
7240*	Relief Air	Blue
7241*	Return	Blue
7242*	Return	Green
7243*	Return	Red
7244*	Return	Yellow
7245*	Ret. Activated Sludge	Yellow
7246*	River Water	Green
7247*	Roof Drain	Green
7248*	Salt Water	Green
7249*	Sanitary Drain	Green
7250*	Sanitary Sewer	Green
7251*	Sanitary Sewer	Yellow
7252*	Sanitary Vent	Yellow
7253*	Sanitary Waste	Yellow
7254*	Seal Water	Green
7255*	Secondary	Green
7256*	Service Air	Yellow

Catalog Number	Legend	Bkgd Color
7257*	Service Water	Green
7258*	Sewage	Yellow
7259*	Sewer	Green
7260*	Sludge	Yellow
7261*	Slurry	Yellow
8804*	Soap	Yellow
7262*	Sodium Chlorate	Yellow
7263*	Sodium Hydroxide	Yellow
7264*	Sodium Hypochlorite	Yellow
7265*	Soft Water	Green
7266*	Solvent	Yellow
8807*	Spent Acid	Yellow
7267*	Sprinkler	Red
7268*	Sprinkler Fire	Red
7269*	Sprinkler Water	Red
7270*	Steam	Yellow
7271*	Steam Return	Yellow
7272*	Steam Supply	Yellow
7273*	Storm Drain	Green
7274*	Storm Sewer	Green
7275*	Storm Water	Green
7276*	Suction	Yellow
8808*	Sulfur	Yellow
7277*	Sulfur Dioxide	Yellow
7278*	Sulfur Dioxide Liquid	Yellow
7279*	Sulfuric Acid	Yellow
7280*	Sump Pump Discharge	Yellow
7281*	Supply	Blue
7282*	Supply	Green
7311*	Supply	Yellow
8809*	Tank Drain	Yellow
7283*	Tempered Water	Yellow
7284*	Toluene	Yellow
7285*	Tower Water	Green
7286*	Tower Water Return	Green
7287*	Tower Water Supply	Green
7288*	Transfer	Yellow
7289*	Treated Water	Green
7290*	Unsafe Water	Yellow
7291*	Vacuum	Yellow
7292*	Vacuum	Green
7293*	Valve	Yellow
7294*	Vapor	Yellow
7295*	Vent	Yellow
7296*	Vent	Green
7297*	Vent	Blue
8920*	Warm Water	Green
7298*	Waste	Yellow
7299*	Waste	Green
7300*	Waste Activated Sludge	Yellow
7301*	Waste Water	Green
7302*	Waste Water	Yellow
7303*	Water	Yellow
7304*	Water	Green
8921*	Weak Black Liquor	Yellow
8922*	Weak White Liquor	Yellow
7305*	Well Water	Green
8923*	White Liquor	Yellow
7306*	White Water	Yellow

## Spanish Legends

Legend	Bkgd Color	Style 1HV	Style 1	Style 4	Style 3C
AGUA	Green	83596	83540	83576	83615
AGUA DE REFRIGERACION	Green	83484	83424	83460	-
AGUA FRIA	Green	-	83418	83453	83498
AGUA POTABLE	Yellow	-	83522	83558	-
AGUA REFRIGERADA	Green	83477	83414	83449	-
AGUA PROTEC. PAPA INCENDIOS	Red	-	83430	83466	-
AIRE	Blue	-	83400	83436	-
AIRE COMPRIMIDO	Blue	-	83421	83456	83501
AIRE USO MEDICO	Yellow	-	83514	83550	83599
CAUSTICA	Yellow	-	83413	83448	83496

Legend	Bkgd Color	Style 1HV	Style 1	Style 4	Style 3C
DESAGUE SANITARIO	Green	83589	83527	83563	-
GAS	Yellow	83489	83432	83468	83505
GAS NATURAL	Yellow	83585	83517	83553	83601
HIDROGENO	Yellow	-	83510	83545	83598
OXIGENO	Green	-	83520	83556	83604
RESPIRADERO	Yellow	-	83537	83573	83612
RETORNO DE AGUA REFRIGERADA	Green	83478	83415	83450	-
SUMINISTRO AGUA REFRIGERADA	Green	83479	83416	83451	-
VACIO USO MEDICO	White	-	83515	83551	83600
VAPOR	Yellow	83590	83530	83566	83607



# Self-Sticking Pipe Markers

BradyID.com/s34

Pipe Markers



## Food & Beverage Self-Sticking Pipe Markers

- Laminated B-681 polyester seals in and protect graphics
- Industrial grade self-adhesive protects against bacteria or moisture trapping behind the pipe marker
- All stock markers meet ASME (ANSI) when used with arrow tape
- For clean room applications, the material liner should be removed prior to entering the clean room

### Style and Size Chart

Style Code	Outside Diameter	Letter Height	Style Description	Style Example
Style: 1	2-1/2" to 7-7/8"	2"	One 2-1/4" x 14" marker per card	<b>HEATING RETURN</b>
Style: 1HV	8" or greater	3-1/2"	One 4" x 24" marker per card	<b>HEATING RETURN</b>
Style: 3C	less than 34"	1/2"	Three 2-1/4" x 2-3/4" markers per card plus 8 strips of Arrow Tape	
Style: 4	3/4" to 2-3/8"	3/4"	Four 1-1/8" x 7" markers per card	

### Food & Beverage Industry Legends

Legend	Color	Style 1HV	Style 1	Style 4	Style 3C
Boiler Feedwater	Black on Yellow	105735	105736	105737	105738
Carbon Dioxide	Black on Yellow	105739	105740	105741	105742
Chlorine Water	Black on Yellow	105743	105744	105745	105746
Condensate Return	Black on Yellow	105747	105748	105749	105750
DC LIQ Ammonia HIGH	Black on Yellow	105751	105752	105753	105754
Diesel Fuel	Black on Yellow	105755	105756	105757	105758
Glycol Return	Black on Yellow	105759	105760	105761	-
Glycol Supply	Black on Yellow	105763	105764	105765	105766
HGD LIQ Ammonia HIGH	Black on Yellow	105767	105768	105769	105770
High Pressure Steam	Black on Yellow	105771	105772	105773	105774
Hot Water Return	Black on Yellow	105775	105776	105777	105778
Hot Water Supply	Black on Yellow	105779	105780	105781	105782
HTRL LIQ Ammonia LOW	Black on Yellow	105783	105784	105785	105786
HTRS LIQ VAP Ammonia LOW	Black on Yellow	105787	105788	105789	105790
LSS VAP Ammonia LOW	Black on Yellow	105791	105792	105793	105794
LTRL LIQ Ammonia LOW	Black on Yellow	105795	105796	105797	105798
LTRS LIQ VAP Ammonia LOW	Black on Yellow	105799	105800	105801	105802
Natural Gas	Black on Yellow	105803	105804	105805	105806
Compressed Air	White on Blue	105807	105808	105809	105810
Vacuum	White on Blue	105811	105812	105813	105814
Abandoned	White on Green	106063	106064	106065	106066
City Water	White on Green	106067	106068	106069	106070
Condensate Drain	White on Green	106071	106072	106073	106074
Condenser Water Return	White on Green	106075	106076	106077	106078

Legend	Color	Style 1HV	Style 1	Style 4	Style 3C
Condenser Water Supply	White on Green	106079	106080	106081	106082
Cooking Oil	White on Green	106083	106084	106085	106086
Cooling Water Return	White on Green	106087	106088	106089	106090
Cooling Water Supply	White on Green	106091	106092	106093	106094
Corn Oil	White on Green	106095	106096	106097	106098
Domestic Cold Water	White on Green	106099	106100	106101	106102
Domestic Hot water	White on Green	106103	106104	106105	106106
Drain	White on Green	106107	106108	106109	106110
Frying Oil - New	White on Green	106111	106112	106113	106114
High Pressure Water	White on Green	106115	106116	106117	106118
Non-Potable Chilled Water Return	White on Green	106119	106120	106121	106122
Non-Potable Chilled Water Supply	White on Green	106123	106124	106125	106126
Non-Potable Water	White on Green	106127	106128	106129	106130
Potable Chilled Water Return	White on Green	106131	106132	106133	106134
Potable Chilled Water Supply	White on Green	106135	106136	106137	106138
Potable Heat Reclaim	White on Green	106139	106140	106141	106142
Potable Water	White on Green	106143	106144	106145	106146
Potable Water - Cold	White on Green	106147	106148	106149	106150
Potable Water - Hot	White on Green	106151	106152	106153	106154
Salad Oil	White on Green	106155	106156	106157	106158
Virgin Oil	White on Green	106159	106160	106161	106162
Sprinkler Water	White on Red	106163	106164	106165	106166

### Food and Beverage Directional Flow Arrow Tape

- B-302 self-sticking vinyl with protective overlaminat
- For clean room application the material liner should be removed prior to entering the clean room
- Meets ASME (ANSI) when used with the standard pipe marker



Color	1" x 30 yds	2" x 30 yds	4" x 30 yds
White on Red	-	106168	106169
White on Green	-	106171	106172
White on Blue	-	106174	106175
Black on Yellow	106176	106177	106178



## Roll Form Pipe Markers

- Eliminates need for precise measurement of pipe diameter -- simply cut to the size you need from 30' long roll
- B-946 material adheres to itself for easy wrap-around marker installation
- Legend repeats 65 times per roll
- Available in both 8" and 12" widths

Legend	Color	8" x 30'	12" x 30'
(Blank)	Clear	41594	15504
(Blank)	Yellow	41596	-
(Blank)	Green	41597	-
(Blank)	Blue	41598	15507
(Blank)	Red	41599	15508
(Blank)	Black/Yellow	41532	15509
Lb Steam	Black/Yellow	41483	15600
Acid	Black/Yellow	41538	15500
Alum	Black/Yellow	41539	15501
Asbestos Free	White/Blue	41593	15502
Black Liquor	Black/Yellow	41523	15503
Bleached Liquor	Black/Yellow	52641	52642
Bleach Stock	Black/Yellow	52643	52644
Boiler Feed Water	Black/Yellow	41537	15512
Caustic	Black/Yellow	41545	15515
Caustic Soda	Black/Yellow	41535	15516
Chilled Water	White/Green	41518	15517
Chlorine	Black/Yellow	41530	15518
Chlorine Gas	Black/Yellow	41549	15520
Circulating Water	White/Green	41551	15521
City Water	White/Green	41522	15522
Cold Water	White/Green	41512	15523
Compressed Air	Black/Yellow	41455	15535
Compressed Air	White/Blue	41456	15536
Condensate	Black/Yellow	41521	15524
Contains Asbestos	Black/Yellow	52665	81728
Cooling Water	White/Green	41457	15537
Danger Asbestos Insulation	Black/Yellow	41592	15526
Danger Contains Asbestos Fibers	Black/Yellow	41595	15527
Demin Water	White/Blue	52673	52674
Domestic Cold Water	White/Green	41458	15538
Domestic Hot Water	Black/Yellow	41459	15539
Drain	White/Green	41460	15540
Filtered Water	White/Green	41554	15530
Fire Auto Sprinklers	White/Red	41461	15541
Fire Protection Water	White/Red	41462	15542
Fresh Water	White/Green	41555	15532
Fuel Oil	Black/Yellow	41463	15543
Gas	Black/Yellow	41464	15544
Green Liquor	Black/Yellow	41527	15533
High Pressure Steam	Black/Yellow	41519	15534
Hot Water	Black/Yellow	41510	15545
Hot Water Return	Black/Yellow	41465	15582
Hot Water Supply	Black/Yellow	41466	15583
Hydrochloric Acid	Black/Yellow	41557	15546

Legend	Color	8" x 30'	12" x 30'
Hydrogen	Black/Yellow	41467	15584
Hydrogen Peroxide	Black/Yellow	41558	15547
Hydrogen Sulfide	Black/Yellow	41559	15548
Industrial Water	White/Green	41468	15585
Lime Mud	Black/Yellow	41560	15549
Low Pressure Steam	Black/Yellow	41520	15550
Make-Up Water	White/Green	41562	15552
Mill Air	White/Blue	41563	15553
Mill Water	White/Green	41564	15554
Natural Gas	Black/Yellow	41511	15556
Noncondensable Gas	Black/Yellow	41565	15555
Oxygen	Black/Yellow	41469	15586
Oxygen	White/Blue	41470	15587
Plant Air	Black/Yellow	41471	15588
Pond Water	White/Green	41567	15557
Potable Water	White/Green	41472	15589
Process Water	White/Green	41568	15558
Raw Water	White/Green	41570	15560
Return	Black/Yellow	41514	15561
Return	White/Green	41515	15562
Roof Drain	White/Green	41473	15590
Sanitary Sewer	Black/Yellow	41474	15591
Seal Water	White/Green	41572	15563
Sodium Hypochlorite	Black/Yellow	41575	15566
Sprinkler Fire	White/Red	41475	15592
Sprinkler Water	White/Red	41476	15593
Steam	Black/Yellow	41513	15567
Storm Drain	White/Green	41477	15594
Sulfur Dioxide	Black/Yellow	41579	15569
Sulfuric Acid	Black/Yellow	41536	15570
Supply	Black/Yellow	41516	15571
Supply	White/Green	41517	15572
Tower Water	White/Green	41478	15595
Treated Water	White/Green	41582	15573
Vacuum	Black/Yellow	41479	15596
Vent	Black/Yellow	41480	15597
Warm Mill Water	Black/Yellow	41584	15574
Waste Water	Black/Yellow	41586	15576
Water	Black/Yellow	41481	15598
Water	White/Green	41482	15599
Weak Wash	Black/Yellow	41589	15578
White Liquor	Black/Yellow	41524	15580
White Water	Black/Yellow	41525	15581



### Need a custom legend?

Contact Brady to customize pipe markers to fit the unique needs of your facility.

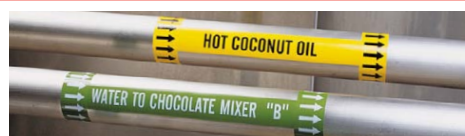

# Self-Sticking Pipe Markers

BradyID.com/s34



Pipe Markers

## Pipe Markers-To-Go

- Made of economical B-736 surface printed plastic for use on smooth, clean, dry pipe surfaces
- Markers withstand temperatures from -40°F to 212°F
- Supplied in rolls of 25 identical markers and matching arrows
- Arrows may be applied to indicate flow in either direction
- Ideal for on-the-spot repair or replacement of damaged or missing markers

Legend	Color	8" x 30'	12" x 30'
(Blank)	Yellow	20483	73944
(Blank)	Green	20484	73945
(Blank)	Blue	20485	73946
(Blank)	Red	20486	73947
Arrow	Yellow	20487	73948
Arrow	Green	20488	73949
Arrow	Blue	20489	73950
Arrow	Red	20490	73951
Acid	Yellow	20400	73860
Air	Blue	20401	73861
Asbestos Free Insulation	Blue	20402	73862
Boiler Blowdown	Yellow	20403	73863
Boiler Feed Water	Yellow	20404	73864
Carbon Dioxide	Yellow	20405	73865
Caustic	Yellow	20406	73866
Chilled Water	Green	20407	73867
Chilled Water Return	Green	20408	73868
Chilled Water Supply	Green	20409	73869
Circulating Water	Green	20410	73870
City Water	Green	20411	73871
Cold Water	Green	20412	73872
Cold Water Return	Green	20413	73873
Cold Water Supply	Green	20414	73874
Compressed Air	Blue	20415	73875
Compressed Air	Yellow	20416	73877
Condensate	Yellow	20417	73878
Condensate Return	Yellow	20418	73879
Condensate Supply	Yellow	20419	73880
Condenser Water Return	Green	20421	73882
Condenser Water Supply	Green	20422	73883
Cooling Water	Green	20424	73885
Domestic Cold Water	Green	20425	73886
Domestic Hot Water	Yellow	20426	73887
Drain	Green	20427	73888
Exhaust	Yellow	20428	73889
Filtered Water	Green	20429	73890
Fire Protection Water	Red	20430	73891
Fuel Oil	Yellow	20431	73892
Gas	Yellow	20432	73893
Glycol	Yellow	20433	73894
Heating	Yellow	20434	73895
Heating Return	Yellow	20435	73896
Heating Supply	Yellow	20436	73897
High Pressure Air	Yellow	20437	73898
High Pressure Condensate	Yellow	20438	73899

Legend	Color	8" x 30'	12" x 30'
High Pressure Steam	Yellow	20439	73900
Hot Water	Yellow	20440	73901
Hot Water Return	Yellow	20441	73902
Hot Water Supply	Yellow	20442	73903
Low Pressure Air	Blue	20443	73904
Low Pressure Condensate	Yellow	20444	73905
Low Pressure Steam	Yellow	20445	73906
Make-Up Water	Green	20446	73907
Medium Pressure Air	Blue	20447	73908
Medium Pressure Steam	Yellow	20448	73909
Natural Gas	Yellow	20449	73910
Nitrogen	Green	20450	73911
Non-Potable Water	Yellow	20452	73913
Oil	Yellow	20453	73914
Oxygen	Yellow	20454	73915
Plant Air	Yellow	20455	73916
Potable Water	Green	20456	73917
Propane Gas	Yellow	20457	73918
Raw Water	Green	20458	73919
Refrigerated Liquid	Yellow	20459	73920
Refrigerated Suction	Yellow	20460	73921
Return	Green	20461	73922
Return	Yellow	20462	73923
Roof Drain	Green	20463	73924
Sanitary Drain	Green	20464	73925
Sanitary Sewer	Green	20465	73926
Sprinkler Fire	Red	20466	73927
Sprinkler Water	Red	20467	73928
Steam	Yellow	20468	73929
Steam Return	Yellow	20469	73930
Steam Supply	Yellow	20470	73931
Storm Drain	Blue	20471	73932
Supply	Green	20472	73933
Supply	Yellow	20473	73934
Tower Water	Green	20474	73935
Vacuum	Green	20475	73936
Vacuum	Yellow	20476	73937
Vent	Green	20477	73938
Vent	Yellow	20478	73939
Waste	Yellow	20479	73940
Waste Water	Green	20480	73941
Water	Green	20481	73942
Water	Yellow	20482	73943



### Did You Know? Directional Flow

Banding each marker with directional flow arrows is recommended to indicate contents flow direction and to secure markers to the pipe.

**View all direction flow tape on page 246.**



# Self-Sticking Pipe Markers

BradyID.com/s34



## Semiconductor & Chemical Pipe Markers

- For use on small diameter piping or tubing 3/4" or less
- Meets ASME A13.1 color specifications
- Made from B-946 self-sticking vinyl with permanent adhesive
- Marker size: 1/2" x 2-1/4" and includes 28 markers per card
- Use with 1" arrow tape

Legend	Color	1/2" x 2-1/4"
(Arrow)	Yellow	91883
(Arrow)	Green	91884
(Arrow)	Red	91885
(Arrow)	Blue	91886
(Arrow)	Orange	91887
(Arrow)	White	91888
(Blank)	Yellow	91889
(Blank)	Green	91890
(Blank)	Red	91891
(Blank)	Blue	91892
(Blank)	Orange	91893
(Blank)	White	91894
Acetone	Yellow	91895
Acid	Yellow	91896
Acid Waste	Yellow	91897
Air	Green	91898
Ammonia	Yellow	91899
Argon	Yellow	91900
Argon	Green	91901
Carbon Dioxide	Yellow	91906
Carbon Dioxide	Green	91907
Caustic	Green	91909
Chilled Water	Green	91910

Legend	Color	1/2" x 2-1/4"
Chlorine	Yellow	91911
City Water	Green	91913
Clean Dry Air	Yellow	91914
Clean Dry Air	Green	91915
Cold Water	Green	91916
Compressed Air	Blue	91917
Cooling Water	Green	91918
D.I. Water	Green	91920
Deionized Water	Green	91921
Drain	Yellow	91925
Drain	Green	91926
Exhaust	Yellow	91930
Heating Water	Yellow	91933
Helium	Yellow	91934
Helium	Green	91935
Hot	Yellow	91936
Hot Water	Yellow	91937
Hydrochloric Acid	Yellow	91938
Hydrofluoric Acid	Yellow	91939
Hydrogen	Yellow	91940
Hydrogen Chloride	Yellow	91942
Industrial Water	Green	91943
Isopropyl Alcohol	Yellow	91944

Legend	Color	1/2" x 2-1/4"
Methyl Alcohol	Yellow	91948
Natural Gas	Yellow	91949
Nitrogen	Blue	91997
Nitrogen	Green	91998
Nitrogen Trifluoride	Yellow	91950
Nitrous Oxide	Yellow	91951
Non-Potable Water	Yellow	91953
Oxygen	Yellow	91955
Phosphine	Yellow	91956
Potable Water	Green	91958
Process Cooling Water	Green	91959
Process Vacuum	Green	91961
Return	Yellow	91964
Return	Green	91965
Silane	Yellow	91966
Solvent	Yellow	91967
Spare	Green	91968
Supply	Yellow	91972
Trichlorosilane	Yellow	91974
Vacuum	Green	91977
Vent	Yellow	91978
Vent	Green	91979
Water	Green	91981



## Medical Gas Pipe Markers-On-A-Roll

- Designed to wrap completely around 3/4" piping.
- 3" x 3" markers come complete with direction flow arrows with 1/4" high characters.
- Comply with CGA & NFPA Standards.

Catalog #	Legend	Color	Length	Markers/Roll
98499	Cyclopropane	Black on Orange	15'	60
98621	Helium	White on Brown	15'	60
98838	Medical Vacuum	Black on White	15'	60
98844	Oxygen	White on Green	15'	60

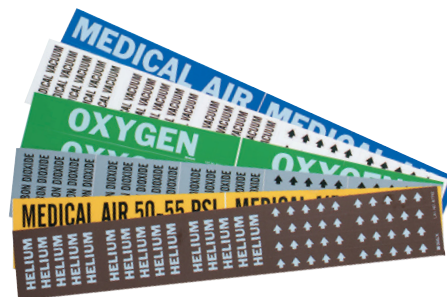

## Medical Gas Pipe Markers

- B-946 vinyl pipe markers
- Style 3C: for pipes with an 3/4" outside dia. or less consists of three 2-1/4" x 2-3/4" wrap around labels and four sets of arrow tape
- Style 4: for pipes with a 1" to 2-1/2" outside dia. consists of four 1-1/8" x 7" labels per card

Legend	Color	Style 3C	Style 4
Carbon Dioxide	White Gray	87740	90307
Helium	White Brown	87742	-
Medical Air	White Blue	7183-3C	7183-4
Medical Air	Black Yellow	7184-3C	7184-4
Medical Air 50-55 Psi	Black Yellow	86330	86331
Medical Vacuum	White Blue	7185-3C	7185-4
Medical Vacuum	Black White	7186-3C	7186-4
Nitrogen	White Black	87745	90331
Nitrogen 180-200 Psi	White Black	86334	-
Nitrous Oxide	White Blue	87746	90333
Nitrous Oxide 50-55 Psi	White Blue	86332	86333
Oxygen	White Green	7210-3C	7210-4
Oxygen 50-55 Psi	White Green	86328	86329



### Medical Gas Marking NFPA Update 99-62:

Gas content and operating pressure of medical gas piping systems shall be readily identifiable by appropriate labeling with the name and pressure of the gas contained. Labels shall appear on the piping at intervals of not more than 20ft (6m). Supplementary color identification shall be in accordance with the Compressed Gas Association pamphlet c-9. For more visit NFPA.org.



# BradySnap-On™ / Strap-On Pipe Markers

BradyID.com/s34

Pipe Markers



## BradySnap-On™ Pipe Markers

- Designed for general purpose pipe identification on pipes that have an outside diameter between 3/4" and 6" (including insulation)
- May be applied to dirty, oily, greasy or rough surfaces
- Meet ASME (ANSI) Standard
- Lightweight coiled plastic can be removed and reapplied



## Strap-On Pipe Markers

- Designed for general purpose pipe identification on pipes that have a 6" or larger diameter (including insulation)
- May be applied to dirty, oily, greasy or rough surfaces
- Can be removed and reapplied in other areas
- Strap-On Pipe Marker styles F - H include nylon straps

### How to order:

1. Choose the desired pipe marker legend below.
2. Replace the asterisk (\*) with the style code (A, B, C, D, F, G or H) from the size charts below to indicate your desired pipe marker size and style. (Example: Air = 4001-H)

### BradySnap-On™ Pipe Marker Style and Size Chart

Style Code	Outside Diameter	Letter Height
Style: A	3/4" to 1-3/8"	1/2"
Style: B	1-1/2" to 2-3/8"	3/4"
Style: C	2-1/2" to 3-7/8"	1-1/4"
Style: D	4" to 6"	1-1/4"

### Strap-On Pipe Marker Style and Size Chart

Style Code	Outside Diameter	Letter Height
Style: F	6" to 7-7/8"	1-1/4"
Style: G	8" to 9-7/8"	2-1/2"
Style: H	10" to 15"	3-1/2"

### BradySnap-On™ and Strap-On Marker Legends

Catalog Number	Legend	Bkgd Color	Catalog Number	Legend	Bkgd Color	Catalog Number	Legend	Bkgd Color
4010-*	(Blank)	Yellow	4165-*	Blower Air	Green	4030-*	Cold Water Return	Green
4011-*	(Blank)	Green	4015-*	Boiler Blowdown	Yellow	4031-*	Cold Water Supply	Green
4012-*	(Blank)	Red	4016-*	Boiler Feed	Yellow	4032-*	Compressed Air	Yellow
4013-*	(Blank)	Blue	4017-*	Boiler Feed Water	Yellow	4033-*	Compressed Air	Green
4157-*	Acetone	Yellow	4167-*	Breathing Air	Green	4034-*	Compressed Air	Blue
4158-*	Acetylene Gas	Yellow	4018-*	Brine	Green	4035-*	Condensate	Yellow
4000-*	Acid	Yellow	4019-*	Carbon Dioxide	Yellow	4036-*	Condensate Drain	Yellow
4001-*	Air	Green	4020-*	Caustic	Yellow	4037-*	Condensate Return	Yellow
4002-*	Air	Blue	4021-*	Caustic Soda	Yellow	4038-*	Condensate Supply	Yellow
4003-*	Air	Yellow	4169-*	Chemical	Yellow	4039-*	Condenser Water	Green
4160-*	Air Supply	Blue	4022-*	Chilled Water	Green	4040-*	Condenser Water Return	Green
4004-*	Alum	Yellow	4023-*	Chilled Water Return	Green	4041-*	Condenser Water Supply	Green
4005-*	Ammonia	Yellow	4024-*	Chilled Water Supply	Green	4042-*	Cooling Water	Green
4162-*	Argon	Blue	4025-*	Chlorine	Yellow	4043-*	Cooling Water Return	Green
4006-*	Argon	Green	4026-*	Chlorine Gas	Yellow	4044-*	Cooling Water Supply	Green
4007-*	Asbestos Free	Blue	4170-*	Circulating Water	Green	4045-*	Danger Asbestos Insulation	Yellow
4008-*	Asbestos Free Insulation	Blue	4027-*	City Gas	Yellow	4046-*	Deionized Water	Green
4009-*	Asbestos Insulation	Yellow	4028-*	City Water	Green	4172-*	Deionized Water Return	Green
4014-*	Blowdown	Yellow	4029-*	Cold Water	Green	4173-*	Deionized Water Supply	Green



# BradySnap-On™ / Strap-On Pipe Markers

BradyID.com/s34

## BradySnap-On™ and Strap-On Marker Legends (continued)

Catalog Number	Legend	Bkgd Color	Catalog Number	Legend	Bkgd Color	Catalog Number	Legend	Bkgd Color
4174-*	Diesel Oil	Yellow	4083-*	Hydraulic Line	Yellow	4266-*	Reheat Water Return	Yellow
4175-*	Discharge	Green	4199-*	Hydraulic Oil	Yellow	4267-*	Reheat Water Supply	Yellow
4047-*	Distilled Water	Green	4084-*	Hydraulic Supply	Yellow	4119-*	Return	Yellow
4048-*	Domestic Cold Water	Green	4085-*	Hydrochloric Acid	Yellow	4120-*	Return	Green
4049-*	Domestic Cold Water Return	Green	4086-*	Hydrogen	Yellow	4121-*	Roof Drain	Green
4050-*	Domestic Cold Water Supply	Green	4087-*	Hydrogen Peroxide	Yellow	4122-*	Sanitary Drain	Green
4051-*	Domestic Hot Water	Yellow	4088-*	Industrial Water	Green	4123-*	Sanitary Sewer	Green
4052-*	Domestic Hot Water Return	Yellow	4222-*	Instrument Air	Yellow	4269-*	Service Air	Yellow
4053-*	Domestic Hot Water Supply	Yellow	4089-*	Instrument Air	Blue	4270-*	Service Water	Green
4054-*	Drain	Yellow	4225-*	Lab Vent	Yellow	4271-*	Sewage	Yellow
4055-*	Drain	Green	4226-*	Lab Waste	Yellow	4272-*	Sewer	Green
4176-*	Drain Water	Green	4227-*	Liquid Nitrogen	Yellow	4273-*	Sludge	Yellow
4056-*	Drinking Water	Green	4228-*	Low Pressure	Green	4274-*	Soap	Yellow
4177-*	Dye	Yellow	4090-*	Low Pressure Air	Yellow	4275-*	Sodium Hydroxide	Yellow
4178-*	Effluent	Yellow	4229-*	Low Pressure Air	Green	4124-*	Sodium Hypochlorite	Yellow
4179-*	Electric Traced	Yellow	4091-*	Low Pressure Condensate	Yellow	4125-*	Soft Water	Green
4180-*	Engine Oil	Yellow	4240-*	Low Pressure Gas	Yellow	4277-*	Sprinkler	Red
4057-*	Exhaust	Yellow	4241-*	Low Pressure Natural Gas	Yellow	4127-*	Sprinkler Fire	Red
4181-*	Exhaust Air	Blue	4092-*	Low Pressure Steam	Yellow	4128-*	Sprinkler Water	Red
4058-*	Filtered Water	Green	4243-*	Low Pressure Water	Green	4129-*	Steam	Yellow
4184-*	Filtrate	Yellow	4244-*	Lube Oil	Yellow	4130-*	Steam Return	Yellow
4059-*	Fire Auto Sprinklers	Red	4093-*	Make-Up Water	Green	4131-*	Steam Supply	Yellow
4185-*	Fire Main	Red	4094-*	Med. Pressure Condensate	Yellow	4132-*	Storm Drain	Green
4060-*	Fire Protection Water	Red	4095-*	Medium Pressure Steam	Yellow	4133-*	Storm Sewer	Green
4061-*	Freon	Green	4096-*	Medical Air	Blue	4134-*	Storm Water	Green
4186-*	Fresh Water	Green	4245-*	Mixed Gas	Yellow	4135-*	Sulfur Dioxide	Yellow
4062-*	Fuel Gas	Yellow	4097-*	Natural Gas	Yellow	4136-*	Sulfuric Acid	Yellow
4063-*	Fuel Oil	Yellow	4247-*	Nitric Acid	Yellow	4137-*	Sump Pump Discharge	Yellow
4064-*	Fuel Oil Return	Yellow	4098-*	Nitrogen	Yellow	4138-*	Supply	Yellow
4065-*	Fuel Oil Supply	Yellow	4099-*	Nitrogen	Green	4139-*	Supply	Green
4066-*	Fuel Oil Vent	Yellow	4100-*	Nitrogen	Blue	4279-*	Tank Drain	Yellow
4067-*	Gas	Yellow	4101-*	Nitrous Oxide	Yellow	4140-*	Tempered Water	Yellow
4187-*	Gas	Blue	4102-*	Non-Potable Water	Yellow	4141-*	Toluene	Yellow
4068-*	Glycol	Yellow	4103-*	Oil	Yellow	4142-*	Tower Water	Green
4189-*	Glycol Return	Yellow	4248-*	Outside Air	Blue	4143-*	Tower Water Return	Green
4190-*	Glycol Supply	Yellow	4104-*	Overflow	Yellow	4144-*	Tower Water Supply	Green
4070-*	Heating Return	Yellow	4105-*	Oxygen	Yellow	4145-*	Treated Water	Green
4071-*	Heating Supply	Yellow	4106-*	Oxygen	Green	4146-*	Vacuum	Yellow
4072-*	Heating Water Return	Yellow	4107-*	Oxygen	Blue	4147-*	Vacuum	Green
4073-*	Heating Water Supply	Yellow	4249-*	Peroxide	Yellow	4148-*	Vent	Yellow
4074-*	Helium	Green	4108-*	Plant Air	Yellow	4149-*	Vent	Blue
4075-*	High Pressure Air	Yellow	4109-*	Plant Water	Green	4150-*	Vent	Green
4076-*	High Pressure Condensate	Yellow	4110-*	Plumbing Vent	Green	4151-*	Waste	Yellow
4193-*	High Pressure Gas	Yellow	4260-*	Polymer	Yellow	4152-*	Waste Water	Yellow
4194-*	High Pressure Natural Gas	Yellow	4261-*	Potable	Green	4153-*	Waste Water	Green
4195-*	High Pressure Nitrogen	Yellow	4111-*	Potable Water	Green	4154-*	Water	Yellow
4077-*	High Pressure Steam	Yellow	4112-*	Process Water	Yellow	4155-*	Water	Green
4078-*	High Pressure Water	Yellow	4113-*	Process Water	Green	4281-*	Weak Black Liquor	Yellow
4197-*	Hot	Yellow	4114-*	Propane Gas	Yellow	4156-*	Well Water	Green
4079-*	Hot Water	Yellow	4264-*	Pumped Condensate	Yellow	4283-*	White Liquor	Yellow
4080-*	Hot Water Recirculation	Yellow	4115-*	Rain Water	Green			
4081-*	Hot Water Return	Yellow	4116-*	Raw Water	Green			
4082-*	Hot Water Supply	Yellow	4117-*	Refrigerant Liquid	Yellow			
4198-*	Hydraulic Fluid	Yellow	4118-*	Refrigerant Suction	Yellow			



### Can't Find Your Legend? Consider A Custom Pipe Marker

Brady offers a wide variety of custom pipe marker solutions to fit your facility's needs. Customize the color and legend in any of the pipe marker styles seen in this catalog.

View [BradyID.com](http://BradyID.com) or contact Brady Customer Service at 1-888-272-3946.



Pipe Markers

# High Performance Pipe Markers

BradyID.com/s34



## B-689 High Performance Pipe Markers

- PVF overlaminated polyester construction seals in and protects graphics
- Markers resist abrasion, chemicals, high humidity and outdoor weathering
- Pre-coiled for easy wrap-around installation on pipe up to 7-7/8" in diameter

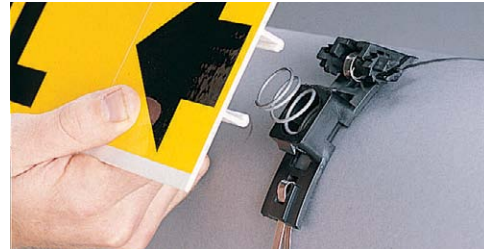

## B-681/B-883 High Performance, High Visibility (HPHV) Markers

- Ideal for pipes 8" and larger in diameter
- Overlaminated graphics are factory applied to a fiberglass plastic carrier
- Easy strap-on installation of fiberglass plastic carrier
- Includes two Heavy-Duty Mounting Clips that apply to pipe using Continuous Stainless Steel Strapping (sold separately)

### How to order:

1. Choose the desired pipe marker legend below.
2. Replace the asterisk (\*) with the style code (0, I, II, or HPHV) from the size charts below to indicate your desired pipe marker size and style. (Example: Air = 5625-II)

### High Performance Pipe Markers Style and Size Chart

Style Code	Outside Dia.	Letter Height	Max Char.
Style: 0	1/2" to 1-3/8"	1/2"	22
Style: I	1-1/2" to 2-3/8"	3/4"	13
Style: II	2-1/2" to 7-7/8"	1-1/4"	13

### HPHV Pipe Markers Style and Size Chart

Style Code	Outside Dia.	Letter Height	Max Char.
Style: HPHV	8" or larger	3-1/2"	16

### High Performance Pipe Marker Legends

Catalog Number	Legend	Bkgd Color
5622-*	Abandoned	Yellow
5624-*	Acid	Yellow
5631-*	Anhydrous Ammonia	Yellow
5632-*	Asbestos Free Insulation	Blue
5634-*	Black Liquor	Yellow
5636-*	Boiler Blowdown	Yellow
5637-*	Boiler Feed Water	Yellow
5643-*	Caustic	Yellow
5645-*	Chemical Feed	Yellow
5647-*	Chilled Water Return	Green
5648-*	Chilled Water Supply	Green
5653-*	Chlorine Water	Yellow
5654-*	Circulating Water	Green
5655-*	City Water	Green
5658-*	Cold Water	Green
5660-*	Compressed Air	Blue
5662-*	Condensate	Yellow
5663-*	Condensate Drain	Green
5664-*	Condensate Return	Yellow
5665-*	Condenser Water Return	Green
5668-*	Cooling Water	Green
5671-*	Deionized Water	Green
5672-*	Demin. Water	Green
5673-*	Domestic Cold Water	Green
5675-*	Domestic Hot Water	Yellow
5676-*	Domestic Hot Water Return	Yellow
5677-*	Domestic Hot Water Supply	Yellow
5678-*	Drain	Green
5685-*	Filtrate	Yellow
5686-*	Fire Auto Sprinklers	Red
5688-*	Fire Protection	Red
5689-*	Fire Protection Water	Red
5691-*	Foul Condensate	Yellow

Catalog Number	Legend	Bkgd Color
5692-*	Fresh Water	Green
5693-*	2# Fuel Oil	Yellow
5694-*	6# Fuel Oil	Yellow
5695-*	Fuel Oil	Yellow
5696-*	Fuel Oil Return	Yellow
5697-*	Fuel Oil Supply	Yellow
5698-*	Gas	Yellow
5699-*	Green Liquor	Yellow
5700-*	Heating Return	Yellow
5701-*	Heating Supply	Yellow
5702-*	Heating Water Return	Yellow
5703-*	Heating Water Supply	Yellow
5706-*	High Pressure Steam	Yellow
5707-*	Hot Water	Yellow
5708-*	Hot Water Return	Yellow
5709-*	Hot Water Supply	Yellow
5710-*	Hydraulic Fluid	Yellow
5712-*	Hydrochloric Acid	Yellow
5715-*	Instrument Air	Yellow
5716-*	Instrument Air	Blue
5718-*	Lime Mud	Yellow
5719-*	Low Pressure Condensate	Yellow
5720-*	Low Pressure Steam	Yellow
5721-*	Lube Oil	Yellow
5722-*	Make-Up Water	Green
5723-*	Medium Pressure Steam	Yellow
5724-*	Mill Air	Blue
5727-*	Nitric Acid	Yellow
5728-*	Nitrogen	Green
5729-*	Nitrogen	Yellow
5730-*	Non-Potable Water	Yellow
5731-*	Noncondensable Gas	Yellow
5734-*	Oxygen	Blue

Catalog Number	Legend	Bkgd Color
5735-*	Oxygen	Green
5736-*	Oxygen	Yellow
5737-*	Peroxide	Yellow
5738-*	Plant Air	Yellow
5739-*	Plant Water	Green
5740-*	Polymer	Yellow
5746-*	Process Water	Yellow
5747-*	Process Water	Green
5748-*	Propane Gas	Yellow
5753-*	River Water	Green
5754-*	Roof Drain	Green
5755-*	Sanitary Sewer	Yellow
5757-*	Seal Water	Yellow
5758-*	Seal Water	Green
5761-*	Sodium Hypochlorite	Yellow
5765-*	Sprinkler Water	Red
5613-*	120# Steam	Yellow
5617-*	200# Steam	Yellow
5767-*	Steam	Yellow
5769-*	Storm Drain	Green
5774-*	Sulfuric Acid	Yellow
5775-*	Treated Water	Green
5776-*	Turpentine	Yellow
5777-*	Vacuum	Green
5778-*	Vacuum	Blue
5779-*	Vacuum	Yellow
5782-*	Warm Mill Water	Green
5783-*	Warm Water	Green
5784-*	Waste Water	Yellow
5787-*	Water	Yellow
5790-*	Well Water	Green
5791-*	White Liquor	Yellow
5793-*	White Water	Green

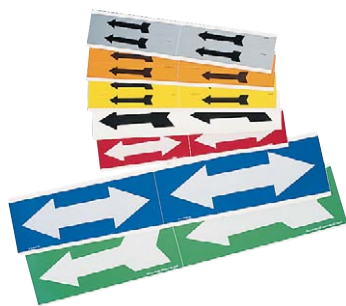

## Self Sticking Vinyl Arrows

- Durable B-946 material withstands the elements indoors or out
- Mounted on easy-to-use cards

	1-1/8" x 7" (4/Card)	2-1/2" x 7" (2/Card)	4" x 12" (2/Card)
<b>Single Direction Arrow</b>			
Blk/Ylw	93242	76507	93390
Wht/Blu	93247	76502	93392
Wht/Rd	93252	76505	93394
Wht/Grn	93257	76503	93396
Blk/Org	93262	76504	-
Blk/Wht	93267	76506	-
Blk/Alum	93272	76501	-
<b>Double Direction Arrow</b>			
Blk/Ylw	93243	76514	93391
Wht/Blu	93248	76509	-
Wht/Rd	-	76512	93395
Wht/Grn	93258	76510	93397



## Directional Flow Arrow Tape

- Durable B-946 material withstands the elements indoors or out
- Provides 360° visibility
- Supplied in liner-mounted rolled form - use two bands per marker

Color	1" x 30 yds (1440 Arrows)	2" x 30 yds (720 Arrows)	4" x 30 yds (270 Arrows)
Blk/Ylw	91424	91420	91287
Wht/Grn	91425	91421	91290
Blk/Grn	91412	91416	91408
Wht/Rd	91426	91422	91288
Wht/Blu	91427	91423	91289
Blk/Wht	91413	91417	91409
Blk/Org	91414	91418	91410
Blk/Gry	91415	91419	91411



## Solid Color Banding Tape

- Durable B-946 material withstands the elements indoors or out
- Meets ASME color field size recommendation when used in combination with worded legends and directional flow arrows

- Supplied in liner-mounted rolled form
- Use two bands per marker

Color	1" x 30 yds	2" x 30 yds	4" x 30 yds
White	91429	91431	91433
Clear	36309	36314	36319
Yellow	36301	55260	36287
Green	36304	55263	36290
Red	36302	55261	36288
Orange	91428	91430	91432
Blue	36303	55262	36289
Brown	36305	36310	36315
Black	36306	36311	36316
Gray	36307	36312	36317
Purple	36308	36313	36318



## Reflective Pipe Banding

- Increase night time visibility throughout your facility
- Made of 5 mil vinyl
- Withstands temperature of -40°F (-40°C) to 180°F (82°C) degrees.
- Exceeds Federal Spec. C-S-300, Class I and FP-79 type II

Color	1" x 30 yds	2" x 30 yds	4" x 30 yds
Yellow	105976	105982	105988
Green	105973	105979	105985
Red	105974	105980	105986
Blue	105972	105978	105984
Orange	105971	105977	105983
White	105975	105981	105987



## ISO 14726 Pipe Banding Tape

- Help reduce accidents and damage to machinery
- Provides 360° visibility
- ISO14726 Marine Standard defines the principle colors for identifying pipes - each color indicates a certain gauge of substances

Color	1" x 30 yds	2" x 30 yds	4" x 30 yds
Green	-	105564	105574
Blue	-	105562	105572
Brown	-	105563	105573
Gray	-	105565	105575
Purple	-	-	105576
Maroon	105557	105567	105577



## Stock IIAR Tape

- Ideal for use with IIAR Pipe Markers
- Made of B-946 Self-Sticking Vinyl
- Use Arrow Tapes to indicate flow direction

Legend	Color	2" x 30 yds	4" x 30 yds
VAP	Black on Blue	55364	55365
HIGH	Black on Red	-	55368
LOW	Black on Green	-	55371



# Pipe Marker Accessories

BradyID.com/s34



## Blank HPHV Carrier

- Ideal for marking custom markers on the spot
- Fiberglass carrier is blank (no label) and comes with two clips for installation
- Sized to accommodate the largest ASME (ANSI) requirements, 4.25" x 32"

Catalog #	Description	Qty.
59918	Blank HPHV Carrier	1

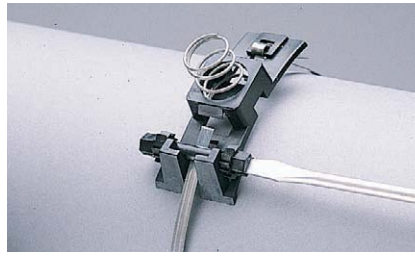

## Stainless Steel Strapping

- Type 316 Stainless Steel Strapping is highly corrosion and heat resistant
- Ideal for HPHV pipe markers, HEET Tags or for your own purpose
- Continuous form requires separate stainless steel heads for uses other than HPHV pipe marker installation (sold separately)

Catalog #	Description
42331	1/4" x 100' steel strapping
42332	1/4" x 250' steel strapping

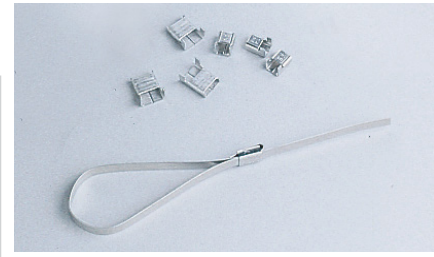

## Stainless Steel Banding Heads

- Use with Continuous Strapping to create secure closures
- Stainless steel heads fit 1/4" strapping (sold separately)

Catalog #	Description	Qty.
90910	Type 316 Stainless Steel	100

Pipe Markers

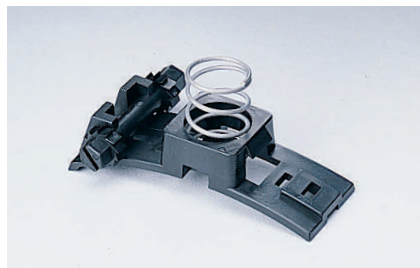

## Heavy-Duty Mounting Clips

- For use with HPHV pipe markers

Catalog #	Description	Qty.
42335	Heavy Duty Clip	1



## Tape Strip Rolls

- Use to re-secure wrap-around pipe markers should they become damaged need to be moved

Catalog #	Description
59946	2" x 30 yards Tape Strip Roll



## Stainless Steel Wire

- 32 mil stainless steel safety wire to be used with wire twister pliers.

Catalog #	Description	Length
15424	Stainless Steel Safety Wire	1800 ft



## Bradylock™ Fastener

- Self-locking heavy duty plastic fastener for Strap-On Markers
- Excellent chemical resistance

Catalog #	Description
41772	1/2" x 150' Bradylock Fastener

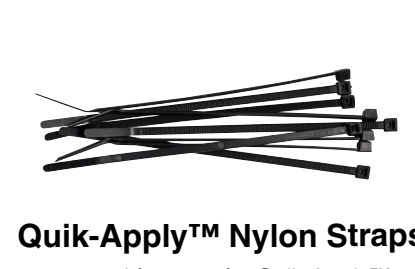

## Quik-ApPLY™ Nylon Straps

- Standard fastener for Quik-ApPLY™ pipe marker sizes Q1-Q4
- Can be used with a variety of tags including valve and lockout/tagouts
- For larger outer diameters, use BradyLock™ Fasteners

Catalog #	Outside Dia.	Strap Length
91165	1"	6"
91166	2"	7"

## Custom Pipe Markers

Contact Brady to create a custom pipe marking solution for your facility.



# Custom Pipe Marker Order Form

BradyID.com/s34

## Custom Pipe Marker Order Form (Fax completed form to your local distributor)

Order    Quote    Artwork Attached   Ship Via: \_\_\_\_\_ P.O. # or Request # : \_\_\_\_\_

### Customer Information

Company Name: \_\_\_\_\_ Name: \_\_\_\_\_  
 Address1: \_\_\_\_\_ Phone #: \_\_\_\_\_  
 Address2: \_\_\_\_\_ Fax #: \_\_\_\_\_  
 City: \_\_\_\_\_ State: \_\_\_\_\_ Zip: \_\_\_\_\_  
 Email: \_\_\_\_\_

### Distributor Information

Distributor: \_\_\_\_\_ Contact Name: \_\_\_\_\_  
 Account #: \_\_\_\_\_ Fax #: \_\_\_\_\_ Phone #: \_\_\_\_\_

### Pipe Marker Options

B-946 Self-Sticking	
Style Code	Pipe Outside Diameter
3c - (3mrks/card)	Less than 3/4" OD
4 - (4mrks/card)	3/4" to 2-3/8"
1	2-1/2 to 7-7/8" OD
1HV	8" or larger OD

*Arrows sold separately.*

Brady Snap-On	
Style Code	Pipe Outside Diameter
A	3/4" to 1-3/8" OD
B	1-1/2" to 2-3/8" OD
C	2-1/2" to 3-7/8" OD
D	4" to 6" OD
F	6 to 7-7/8" OD
G	8" to 9-7/8" OD
H	10" to 15" OD

B-689 High Performance	
Style Code	Pipe Outside Diameter
O	1/2" to 1-3/8" OD
I	1-1/2" to 2-3/8" OD
II	2-1/2" to 7-7/8" OD
III	8" to 10" OD
IV	10" or larger to 16" OD
V	16" or larger to 22" OD
VI	22" or larger to 26" OD

B-946 Semi Conductor & Chemical	
Style Code	Marker Size
28	1/2" x 2-1/4"

Cable Style	
Style Code	Pipe Outside Diameter
CABLE	3/4" to 5/8" OD

B-681 / B-883 High Performance (HPHV)	
Style Code	Pipe Outside Diameter
HPHV	8" or larger OD

*Markers printed with arrows.*

### Custom Orders

Legend Line 1	Color* (Text / Bkgd)	Pipe Marker Style Code	Material	Quantity
1.				
2.				
3.				
4.				
5.				
6.				
7.				
8.				
9.				
10.				

\* Brady standard pipe markers colors are: Yellow, Green, Red, Blue, White, Grey, Brown, Orange, Black, Purple and Clear. Custom colors are available.



# Lean / Visual Workplace

[BradyID.com/visualworkplace](http://BradyID.com/visualworkplace)

## Visual Workplace

Visual Workplace - also known as Visual Factory or Visual Management – is a lean concept that emphasizes putting critical information at the point of use. Companies that incorporate lean visuals throughout their facility are proven to have higher productivity, reduced waste, and improved safety.

Visuals are also essential to sustaining the success of your lean manufacturing initiatives. They reinforce the standards you put in place, and help your staff and employees detect abnormalities at a glance.

### 3 Tried-and-True Visuals:

#### 1. Color coded shadow boards

Are your tools hard to find, causing wasted time between shift changes? Shadow boards have clear, instructive visuals to store tools and equipment at the point of need. By just glancing at the board, workers can tell that each tool is in the right place.



#### 2. Storage locations

Border lines (e.g. striping or border marking tapes) delineate the space allocated and make it easy to identify when something is missing. But by themselves, they can't ensure that the correct items will be returned to their proper place. That's why you also need labels: a label for the border area and one for the object itself.



#### 3. Emergency egress markings

Your facility should have emergency egress markings to help people safely exit in the event of an emergency. According to IBC/IFC regulations, exits and exit access doors must be marked with approved exit signs. Egress pathways and stairwells should also have glow-in-the-dark markings to facilitate safe exits in dark "lights out" conditions.



**FREE Downloads**

75% of learning is done through visuals. Find out how to create an effective visual workplace.



Download at:  
[BradyID.com/55plusguide](http://BradyID.com/55plusguide)

---

Pocket-sized reference book contains 50 tried-and-true visuals that can help your lean facility

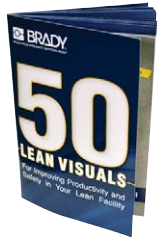

Download at:  
[BradyID.com/visualworkplace](http://BradyID.com/visualworkplace)

## Create your own visuals on-demand with Brady's printing solutions

Brady software and printing systems are essential tools for implementing a visual workplace, making it easy for you to create a limitless variety of visual displays and controls.

**Portable Printers**  
View page 288



**Benchtop Printers**  
View page 346



**Label Creation Software**  
View page 408



## Red Tag Program

- Brady's red tag products are ideal to visually and effectively manage red tag program
- Conforms with ANSI Z535 standards
- Signs are available in three materials:  
B-120 - Premium Fiberglass  
B-302 - Self-Sticking Polyester  
B-401 - Plastic



122289	10" x 7"	B-120
122314	14" x 10"	B-120
122290	10" x 7"	B-302
122313	14" x 10"	B-302
122288	10" x 7"	B-401
122312	14" x 10"	B-401



122274	10" x 7"	B-120
122298	14" x 10"	B-120
122275	10" x 7"	B-302
122299	14" x 10"	B-302
122273	10" x 7"	B-401
122297	14" x 10"	B-401



122286	10" x 7"	B-120
122310	14" x 10"	B-120
122287	10" x 7"	B-302
122311	14" x 10"	B-302
122285	10" x 7"	B-401
122309	14" x 10"	B-401



122268	10" x 7"	B-120
122292	14" x 10"	B-120
122269	10" x 7"	B-302
122293	14" x 10"	B-302
122267	10" x 7"	B-401
122291	14" x 10"	B-401



122271	10" x 7"	B-120
122295	14" x 10"	B-120
122272	10" x 7"	B-302
122296	14" x 10"	B-302
122270	10" x 7"	B-401
122294	14" x 10"	B-401



122277	10" x 7"	B-120
122301	14" x 10"	B-120
122278	10" x 7"	B-302
122302	14" x 10"	B-302
122276	10" x 7"	B-401
122300	14" x 10"	B-401



122280	10" x 7"	B-120
122304	14" x 10"	B-120
122281	10" x 7"	B-302
122305	14" x 10"	B-302
122279	10" x 7"	B-401
122303	14" x 10"	B-401



122283	10" x 7"	B-120
122307	14" x 10"	B-120
122284	10" x 7"	B-302
122308	14" x 10"	B-302
122282	10" x 7"	B-401
122306	14" x 10"	B-401

## Brief Red Tags



Front

Back

Catalog #	Description	Material	Size	Qty.
121521	Brief Red Tag	Cardstock	3" x 5.75"	100

## Detailed Red Tags



Front

Back

Catalog #	Description	Material	Size	Qty.
121522	Detailed Tag	Cardstock	4" x 7"	100



## Red Tag Binder Station

- Polycarbonate backboard with wire rack
- Binder: 10" W x 11" H x 2" D  
Rack: 14" W x 9" H

Catalog #	Description	Board Size	Qty.
122053	Station with binder	14" x 20"	1
122051	Station without binder	14" x 20"	1
122052	Binder Only	10" x 11" x 2"	1



## Red Tag Station

- Acrylic backboard with 2 tag pockets, and 100 tags

Catalog #	Description	Board Size	Qty.
122054	Station w/ Brief Red Tags (#121521)	16" x 12"	1
122055	Station w/ Detailed Red Tags (#121522)	16" x 12"	1
122048	Station without tags	16" x 12"	1



## Red Tag Station with Clipboard

- Acrylic station with clipboard, 2 tag pockets, and 100 tags

Catalog #	Description	Board Size	Qty.
122056	Station w/ Brief Red Tags (#121521)	22" x 16"	1
122057	Station w/ Detailed Red Tags (#121522)	22" x 16"	1
122049	Station without tags	22" x 16"	1
122050	Clipboard Only	9.5" x 14"	1

# ToughStripe® Floor Marking

BradyID.com/toughstripe



**TOUGHSTRIPES®**  
Floor Marking



**Online Video:**  
[BradyID.com/toughstripe](http://BradyID.com/toughstripe)

## Superior Durability

- Withstands forklift traffic without tearing or lifting
- Low-profile design minimizes tears and scratches
- Rugged polyester with ultra-aggressive adhesive

## Easy Application

- Can be easily applied by one person working alone
- Stiff polyester with liner prevents tape stretching and reduces wrinkles and wavy, uneven lines
- No special floor preparation required – just clean with common cleansers

## High Visibility

- High-gloss surface shines like new paint
- Low profile minimizes debris buildup along the edges that occurs with thicker (extruded) floor tapes
- Surface resists marks and smudges
- Available in a variety of high-impact stock and custom colors

## Diecut Shapes

- Dashes, dots, arrows, footprints, and corner marks
- Longer lasting markings – Minimizes the risk of damage and facilitates fast repair

## Pre-Spaced Shapes

- Dots, arrows and dashes packaged in rolls and evenly spaced 18" apart on a continuous liner eliminates the need to apply markings one by one
- Quick and easy one person installation; simply lay down the line like a continuous tape, and then remove the clear transfer tape from on top of the floor markings
- Quickly lay straight, evenly spaced shapes
- Ideal for high traffic areas – if damaged only replace damaged shapes

## Painless Removal

- Does not chip and flake when being removed – comes off in one piece
- Clean removal without any unsightly adhesive residue or damage to the floor



Diecut Shapes



Print On-Demand



Superior Durability



Easy Application

### Use ToughStripe® Floor Marking products to mark:

- Aisleways and traffic lanes
- Work cell outlines
- Equipment storage areas
- Material storage areas
- QA inspection areas
- Defects/scrap/rework areas
- "Keep clear" zones
- Hazard areas

## ToughStripe® Floor Tape Adhesion Rates

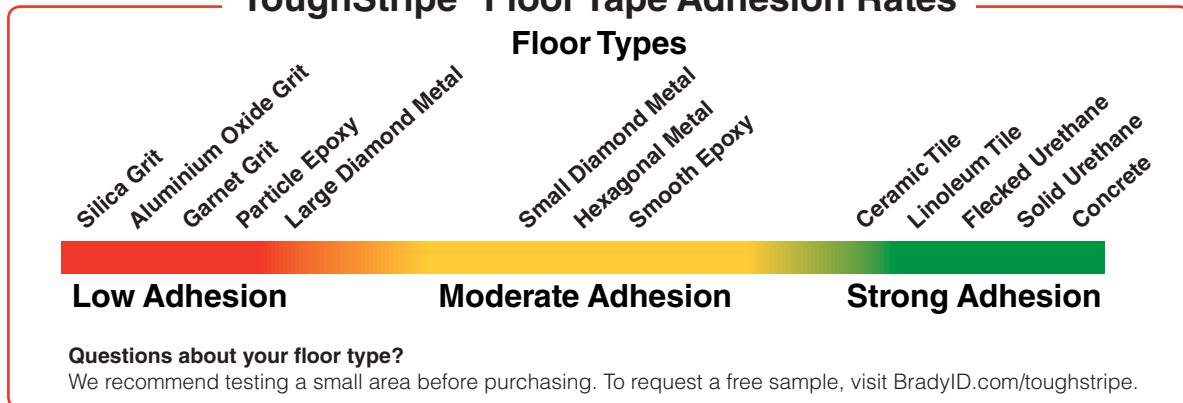

\* For maximum performance, apply ToughStripe Floor Marking products to flat, non-coated concrete.



# ToughStripe® Floor Marking Tape

BradyID.com/toughstripe



## B-514 Toughstripe Floor Marking Polyester

ToughStripe products are ideal for marking aisles, passageways and storage locations, and pointing out important safety equipment and egress paths.

- Exceeds safety standards for clean, dry non-slip surfaces per ANSI A1264.2-2006 and OSHA 1910.22
- 2mm thickness and service temperature range of 0°F – 129°F
- Resists harsh chemicals



### Solid Colored ToughStripe® Tape

	2" x 100'	3" x 100'	4" x 100'
Black	104310	104340	104370
White	104311	104341	104371
Red	104313	104343	104373
Green	104315	104345	104375
Blue	104314	104344	104374
Orange	104316	104346	104376
Yellow	104312	104342	104372
Purple	134086	134087	134088
Brown	134089	134090	134091
Grey	134092	134093	134094



### Striped ToughStripe® Tape

	2" x 100'	3" x 100'	4" x 100'
Blk/Ylw Striped	104317	104347	104377
Blk/Wht Striped	104319	104349	104379
Blk/Org Striped	132433	132434	132435
Rd/Wht Striped	104318	104348	104378
Rd/Ylw Striped	132430	132431	132432
Grn/Wht Striped	132436	132437	132438
Ylw/Blu Striped	132439	132440	132441



### Checked ToughStripe® Tape

	2" x 100'	3" x 100'	4" x 100'
Blk/Wht Checkered	121913	121914	121915
Rd/Wht Checkered	121916	121917	121918



## Toughstripe Overlamine Tape

- Highly durable overlamine
- Easy to apply, easy to remove

### Overlamine Tape

Catalog #	Description	Size
142134	Overlamine	1" x 50'
142135	Overlamine	2" x 50'
142136	Overlamine	1.125" x 100
142137	Overlamine	2.250" x 100'
142138	Overlamine	3" x 100'
142139	Overlamine	4" x 100'

Lean / Visual Workplace



## Want More Information On Floor Marking?

Download the free 5S Floor Marking Color Reference Guide to learn how strategic floor marking can stabilize operations and sustain improvements.

- Color guidelines for marking aisles, equipment areas, & safety hazards
- How-to tips for visually delineating work areas and pathways
- Best practices for identifying designated storage locations for materials, products tools and equipment

Visit [BradyID.com/visualworkplace](http://BradyID.com/visualworkplace) to download now.



# ToughStripe® Floor Marking Tape

BradyID.com/toughstripe

## ToughStripe® Floor Marking Diecut Shapes

- All the durability and high visibility of ToughStripe Floor marking tape, but in diecut shapes
- Easy installation; lay down the continuous tape, and then remove the clear transfer tape. No need to apply markings one by one

Lean / Visual Workplace

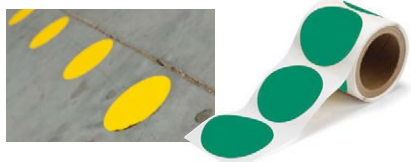

### Dots

	3.5" Dia. 350/roll
Black	104404
White	104405
Red	104400
Green	104401
Blue	104402
Yellow	104403



### Arrows

	2" x 5" 100/pack	3" x 8" 100/pack	4" x 10" 100/pack
Black	104416	104422	104428
White	104417	104423	104429
Red	104412	104418	104424
Green	104413	104419	104425
Blue	104414	104420	104426
Yellow	104415	104421	104427



### Footprints

	10' x 3.5" 5 right & 5 left/pack
Black	104410
White	104411
Red	104406
Green	104407
Blue	104408
Yellow	104409



### Corner "L" Marks

	2" x 5" 20/pack	3" x 8" 20/pack	4" x 10" 20/pack
Black	104434	104446	104458
White	104435	104447	104459
Red	104430	104442	104454
Green	104431	104443	104455
Blue	104432	104444	104456
Yellow	104433	104445	104457



### Center "+" Marks

	2" x 5" 20/pack	3" x 8" 20/pack	4" x 10" 20/pack
Black	104470	104476	104482
White	104471	104477	104483
Red	104466	104472	104478
Green	104467	104473	104479
Blue	104468	104474	104480
Yellow	104469	104475	104481



### Divider "T" Marks

	2" x 5" 20/pack	3" x 8" 20/pack	4" x 10" 20/pack
Black	104440	104452	104464
White	104441	104453	104465
Red	104436	104448	104460
Green	104437	104449	104461
Blue	104438	104450	104462
Yellow	104439	104451	104463



## Pre-Spaced ToughStripe® Shapes

- Quickly lay straight, evenly spaced shapes
- Packaged in rolls (not individually) and spaced 18" apart on a continuous liner
- Easy installation; lay down the continuous tape, and then remove the clear transfer tape. No need to apply markings one by one

### Pre-Spaced Shapes

	3.5" x 100' 55 dots/18" apart	2" x 5" x 100' 52 arrows/18" apart	2" x 8" x 100' 46 dashes/18" apart
Black	104525	104554	142178
White	104522	104555	142177
Red	104521	104526	142179
Green	104520	104527	142181
Blue	104524	104528	142180
Yellow	104523	104529	104556



**Customize! - Call Customer Service to order Toughstripe die-cut shapes in custom colors!**

# ToughStripe® Floor Marking Signs

BradyID.com/toughstripe



## B-534 Floor Marking Signs with Anti-Skid Tread

Toughstripe B-534 polyester floor signs resist harsh chemicals and are specifically designed to alert workers of potential dangers and enforce protective equipment requirements.

- Exceeds safety standards for clean, dry non-slip surfaces per ANSI A1264.2-2006 and OSHA 1910.22
- Black areas of signs are coated with anti-skid tread
- 3 mil thickness; Service temperature range of 0°F – 129°F
- US Patent No 8,302,337



Arrow Symbol  
104489 - 17" dia.



Emergency Exit  
104495 - 17" dia.



Emergency Stairs  
104496 - 17" dia.



Exit Arrow  
104490 - 17" dia.



Fire Extinguisher  
104492 - 17" dia.



Fire Alarm  
104493 - 17" dia.



Fire Hose  
104494 - 17" dia.



Pedestrian Traffic Only  
104509 - 17" dia.



Watch Out For Fork Lift  
104501 - 17" dia.



Warning Forklift Traffic  
104512 - 17" dia.



Production Area  
104513 - 17" dia.



First Aid w/Arrow  
104486 - 17" dia.



Safety Shower  
104487 - 17" dia.



Eye Wash  
104507 - 17" dia.



Stop  
104511 - 17" dia.



Keep Aisles Clear  
104508 - 17" dia.



Radiation Area  
104488 - 14" x 18"



First Aid  
104491 - 14" x 18"



Do Not Enter  
104497 - 14" x 18"



Chemical Storage  
104498 - 14" x 18"



Watch Your Step  
104499 - 14" x 18"



No Smoking  
104500 - 14" x 18"



Ear Protection Area  
104502 - 14" x 18"



Eye Protection Area  
104503 - 14" x 18"



Hard Hat Area  
104504 - 14" x 18"



Safety Goggles Required  
104505 - 14" x 18"



Biohazard  
104506 - 14" x 18"



Safety Glasses Required  
104510 - 14" x 18"

Lean / Visual Workplace



# ToughStripe® Numbers & Letters

BradyID.com/toughstripe



## ToughStripe® Numbers and Letters

- Ideal for marking aisle-ways, shipping and receiving docks, distribution centers, or other areas of your facility
- Easy-to-see 6"W x 8"H numbers and letters available in six high visibility colors
- Each pack contains 20 sheets of the designated legend or Punctuation Set
- Each Punctuation Set includes: two periods, one comma, one exclamation point, one question mark, one forward slash, one dash, and one ampersand (&)

Legend	Black	White	Red	Green	Blue	Yellow
A	121691	121692	121693	121694	121695	121696
B	121697	121698	121699	121700	121701	121702
C	121703	121704	121705	121706	121707	121708
D	121709	121710	121711	121712	121713	121714
E	121715	121716	121717	121718	121719	121720
F	121721	121722	121723	121724	121725	121726
G	121727	121728	121729	121730	121731	121732
H	121733	121734	121735	121736	121737	121738
I	121739	121740	121741	121742	121743	121744
J	121745	121746	121747	121748	121749	121750
K	121751	121752	121753	121754	121755	121756
L	121757	121758	121759	121760	121761	121762
M	121763	121764	121765	121766	121767	121768
N	121769	121770	121771	121772	121773	121774
O	121775	121776	121777	121778	121779	121780
P	121781	121782	121783	121784	121785	121786
Q	121787	121788	121789	121790	121791	121792
R	121793	121794	121795	121796	121797	121798
S	121799	121800	121801	121802	121803	121804

Legend	Black	White	Red	Green	Blue	Yellow
T	121805	121806	121807	121808	121809	121810
U	121811	121812	121813	121814	121815	121816
V	121817	121818	121819	121820	121821	121822
W	121823	121824	121825	121826	121827	121828
X	121829	121830	121831	121832	121833	121834
Y	121835	121836	121837	121838	121839	121840
Z	121841	121842	121843	121844	121845	121846
0	121847	121848	121849	121850	121851	121852
1	121853	121854	121855	121856	121857	121858
2	121859	121860	121861	121862	121863	121864
3	121865	121866	121867	121868	121869	121870
4	121871	121872	121873	121874	121875	121876
5	121877	121878	121879	121880	121881	121882
6	121883	121884	121885	121886	121887	121888
7	121889	121890	121891	121892	121893	121894
8	121895	121896	121897	121898	121899	121900
9	121901	121902	121903	121904	121905	121906
Punctuation Set	121907	121908	121909	121910	121911	121912

Lean / Visual Workplace

## Premium 5S Marking Kits with ToughStripe® Floor Marking Tape

Brady's Premium 5S Marking Kits provide everything you need to 5S your facility, enhancing workplace organization & efficiency.

### Premium 5S Marking Kit includes:

- ToughStripe® Floor Marking Tape
  - 4 Rolls of 2" ToughStripe floor tape (1 yellow, 1 red, 1 blue, 1 green)
  - 4 Packages of 2" L-shaped corner marks (1 yellow, 1 red, 1 blue, 1 green)
- Toolboard / Workbench Marking Tapes
  - 4 Rolls of 12" shadow vinyl (1 black, 1 red, 1 blue, 1 green)
  - 4 Rolls of ½" border tape (1 black, 1 red, 1 blue, 1 green)
  - 4 Rolls of ½" L-shaped corner marks (1 black, 1 red, 1 blue, 1 green)

### Premium 5S Kit with BMP®71 Label Printer includes:

- All contents of Premium 5S Marking Kit above, plus:
- BMP®71 Printer with hard carrying case and charger/AC power adaptor
- 3 White vinyl tape cartridges (1/2", 1", 2")
- 1 Yellow vinyl tape cartridge (2")
- 2 Ribbon cartridges (1 black, 1 red)



\* Premium Kit with BMP71 Label Printer shown.

Catalog #	Description
142109	Premium 5S Kit
142111	Premium 5S Kit with BMP71 Label Printer

For more information on the BMP®71 Label Printer, view page 324

# ToughStripe® Floor Marking Tape

BradyID.com/toughstripe



For information on Globalmark®2 Printer view page 380.



For information on BMP®71 Printer view page 324.

## B-483 Print-On-Demand Floor Labels

ToughStripe® floor tape is available in printable label cartridges, which can be used to create custom floor labels. The printable labels feature the same durability and performance as ToughStripe floor marking tape, making them an ideal solution for identifying designated storage locations and providing visual instructions on the shop floor.

- Easy 3-step process: Print desired label from a select Brady printer, position on floor and apply included B-634 polyester overlamine

## GlobalMark®2 ToughStripe Floor Marking Tape With Overlamine

	1.125" x 100'	2.25" x 100'	3" x 100'	4" x 100'
White	142155	142154	142156	142157
Black	142159	142158	-	142160
Yellow	142162	142161	142163	142164
Red	142166	142165	-	142167
Blue	142169	142168	-	142170
Green	142172	142171	-	142173
Orange	142175	142174	-	142176

\* Specialty black ribbon catalog #96089 required to print on ToughStripe floor tape. Use standard white ribbon catalog #76741 for white text.

## BMP®71 ToughStripe Floor Marking Tape With Overlamine

	1" x 50'	2" x 50'
White	M71-1000-483-WT-KT	M71-2000-483-WT-KT
Black	M71-1000-483-BK-KT	M71-2000-483-BK-KT
Yellow	M71-1000-483-YL-KT	M71-2000-483-YL-KT
Red	M71-1000-483-RD-KT	M71-2000-483-RD-KT
Blue	M71-1000-483-BL-KT	M71-2000-483-BL-KT
Green	M71-1000-483-GN-KT	M71-2000-483-GN-KT
Orange	M71-1000-483-OR-KT	M71-2000-483-OR-KT

\* Specialty black ribbon catalog #M71-R6000 required to print on ToughStripe floor tape. Use standard white ribbon catalog #M71-R4400-WT for white text.

## Pre-Printed Legends and Custom ToughStripe® Tape Now Available!

- Custom colored ToughStripe tape (just supply the PMS#)
- Custom text and legends on the ToughStripe tape
  - Custom legends communicate why the area is marked or blocked off
  - Provides more of a visual workplace and helps productivity
  - 18 character limit, can also include pictograms

Call customer service at 1-888-272-3946 today to get started visually marking your facility!



Pre-printed legends

Custom legends and colors available

### ToughStripe Stock Legends

	2" x 100'	3" x 100'	4" x 100'
Orange "QA Inspection Area"	121364	121365	121366
Yellow "Caution ESD Area"	121367	121368	121369

## How To Apply ToughStripe® Floor Marking Tape

- 1. Clean Surface:** Sweep and clean area and allow floor to dry completely before application.
- 2. Position Tape:** Keeping the liner in place, position tape along entire desired path.
- 3. Remove Liner:** Start at one end and peel the liner away from the tape while smoothing down the tape and providing lamination pressure.

\*For maximum performance, apply ToughStripe floor tape to flat, non-coated, concrete.

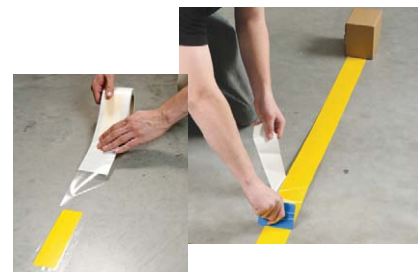

# Visual Workplace Marking

BradyID.com/visualworkplace

Lean / Visual Workplace

**NEW!**



## Custom Visual Workplace Shadow Boards

Brady Shadow Boards use clear, professional-looking graphics to improve workplace organization and efficiency. With easily-identifiable storage for equipment, tools and janitorial supplies, shift changes will become seamless as employees can quickly glance at the shadow board to identify what items are missing from their work area.

In addition, shadow boards are easy to install and are customized to meet tool size specifications, facility visual needs and lean/5S efforts.

**Contact Brady Customer Service to create Shadow Boards for your facility.**



## Border Marking Tape

- Ideal for Solid borders, dividing lines
- Place color-coded bands on tools for easy identification

Catalog #	Size	Color
121122	1/4" x 50' tape	Red
121127	1/2" x 50' tape	Red
121125	1/4" x 50' tape	Green
121130	1/2" x 50' tape	Green
121126	1/4" x 50' tape	Black
121131	1/2" x 50' tape	Black
121124	1/4" x 50' tape	Yellow
121129	1/2" x 50' tape	Yellow
121128	1/2" x 50' tape	Blue
121123	1/4" x 50' tape	Blue



## L-Shaped Corner Markings

- Use corner marks to quickly define storage locations on workbenches, desktops & shelves

Catalog #	Size	Color	Qty.
121413	1" x 1" L-Shaped	Red	750/roll
121416	1" x 1" L-Shaped	Green	750/roll
121417	1" x 1" L-Shaped	Black	750/roll
121415	1" x 1" L-Shaped	Yellow	750/roll
121414	1" x 1" L-Shaped	Blue	750/roll



## T-Shaped Corner Markings

- Use corner marks to quickly define storage locations on workbenches, desktops & shelves

Catalog #	Size	Color	Qty.
121418	1.5" x 1" T-Shaped	Red	545/roll
121421	1.5" x 1" T-Shaped	Green	545/roll
121422	1.5" x 1" T-Shaped	Black	545/roll
121420	1.5" x 1" T-Shaped	Yellow	545/roll
121419	1.5" x 1" T-Shaped	Blue	545/roll



## Shadow Vinyl Rolls

- Quickly and easily create tool shadows to exact size and shape
- Simply place tool on vinyl, trace outline with pen and cut out with scissors

Catalog #	Size	Color
121117	12" x 12'	Red
121120	12" x 12'	Green
121121	12" x 12'	Black
121119	12" x 12'	Yellow
121118	12" x 12'	Blue



## Reflective Tape

- Made of B-957 reflective tape
- Give an extra margin of safety in low light conditions

Color	2" x 15'	3" x 15'
<b>Solid Tape</b>		
Yellow	78986	78988
White	78985	78987
Orange	78989	78990
<b>Striped Tape</b>		
Blk/Ylw	76308	76312
Rd/Wht	76309	76313
Blk/Wht	76310	-
<b>Checked Tape</b>		
Blk/Ylw	76321	-



## Aisle Marking Tapes

- Made of long-wearing B-7569 vinyl tape
- Applies quickly and sticks tightly

*Not compatible with Universal Line Applicator*

Color	2" x 36 yd.	3" x 36 yd.	4" x 36 yd.
<b>Solid Tape</b>			
Yellow	58200	58250	102838
Red	58201	58251	102836
Green	58202	58252	102834
White	58203	58253	102837
Blue	58220	58221	102833
Black	58222	58223	102839
Orange	102825	102829	102835
Brown	102828	102832	102840
Purple	102827	102831	-
Grey	102826	102830	-



## Warning Tape

- B-950 vinyl with permanent adhesive stands up to tough indoor conditions
- Colors sealed beneath protective layer of abrasion resistant clear vinyl

Color	1" x 18 yd.	1.5" x 18 yd.	2" x 18 yd.	3" x 18 yd.
<b>Striped Tape</b>				
Blk/Ylw	55300	55301	55302	55303
Blk/Wt	55290	55291	55292	55293
Mag/Ylw	-	55312	55313	55314
Rd/Wht	55294	55295	55296	55297
Grn/Wht	-	-	90019	90020
<b>Checked Tape</b>				
Blk/Ylw	-	76317	76319	-
Blk/Wt	-	76316	76318	-

# Visual Workplace Marking

BradyID.com/visualworkplace



## Footprints

- Single footprints made of vinyl and designed for easy hand application

Catalog #		Color	Size	Qty.
Left Foot	Right Foot			
121405	121406	Yellow	12"	1 ea.
121407	121408	Green	12"	1 ea.
121409	121410	Red	12"	1 ea.
121411	121412	White	12"	1 ea.
121400	121399	Blue	12"	1 ea.
121402	121401	Orange	12"	1 ea.
121404	121403	Black	12"	1 ea.



## Vinyl Aisle Marking Dots

- B-7569 aisle marking vinyl dots are designed for easy hand application

Catalog #	Size	Color	Qty.
121033	2" dia. Dot	Yellow	500
121034	3" dia. Dot	Yellow	500
121035	4" dia. Dot	Yellow	500
121036	5" dia. Dot	Yellow	500
121039	2" dia. Dot	Red	500
121139	3" dia. Dot	Red	500
121040	2" dia. Dot	Green	500
121041	3" dia. Dot	Green	500
121042	2" dia. Dot	White	500
121043	3" dia. Dot	White	500

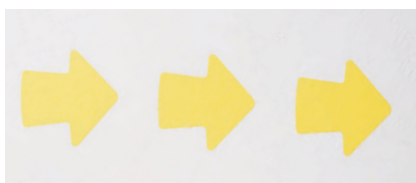

## Vinyl Aisle Marking Arrows

- B-7569 vinyl is ideal for floor application
- Aisle marking dots are designed for easy hand application.

Catalog #	Size	Color	Qty.
121051	3" Arrow	Red	100
121046	2" Arrow	Yellow	100
121047	3" Arrow	Yellow	100
121048	4" Arrow	Yellow	100
121049	5" Arrow	Yellow	100



## Removable Footprints

- Durable, skid-resistant with footprints with removable back
- Standard package: 5 left and 5 right

Catalog #	Description	Size	Qty.
31550	Yellow Feet	11.875" x 3.75"	5 sets
31551	Green Feet	11.875" x 3.75"	5 sets
31552	Blue Feet	11.875" x 3.75"	5 sets
31553	Red Feet	11.875" x 3.75"	5 sets



## Roll Mounted Dots

- B-7569 vinyl dots are designed for machine application

Catalog #	Size	Color	Qty.
121037	2" dia.	Yellow	1,000/roll
121038	3" dia.	Yellow	1,000/roll
121044	2" dia.	White	1,000/roll
121045	3" dia.	White	1,000/roll
121050	3" dia.	Green	1,000/roll

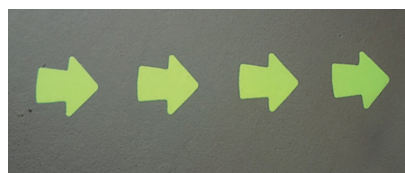

## Glow-In-The-Dark Arrows

- Photoluminescent arrows designed for safe exit during power outages and emergency situations
- 10+ hour glow life

Catalog #	Description	Size	Qty.
93275	Arrows	12"	100

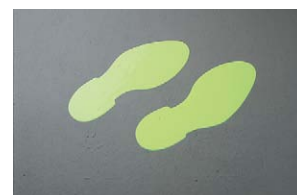

## Glow-In-The-Dark Footprints

- Photoluminescent footprints designed for safe exit during power outages and emergency situations

- 10+ hour glow life

Catalog #	Color	Size	Qty.
55358	Left Foot	12"	1 ea.
55359	Right Foot	12"	1 ea.



## Color-Coded Dots

- Pressure-sensitive paper labels are ideal creating a visual workplace

Catalog #	Size	Color	Qty.
30661	1.5"	Blue	500
30665	3"	Blue	500
30662	1.5"	Red	500
30666	3"	Red	500
30663	1.5"	Green	500
30667	3"	Green	500
30664	1.5"	Yellow	500
30668	3"	Yellow	500

\* Dispensers not included



## Write-On Magnetic Labels

- Re-useable labels with a water-soluble pen that wipes off with a wet cloth
- For a permanent label, use our permanent marking pen (87052)

Catalog #	Size	Color
56957	1" x 50'	Blue
56958	1" x 50'	Green
56959	1" x 50'	Orange
56960	1" x 50'	Red
56961	1" x 50'	White
56962	1" x 50'	Yellow

# Visual Workplace Marking

BradyID.com/visualworkplace



## Warning Message Tapes

- B-950 vinyl with permanent adhesive
- Colors sealed beneath protective layer of abrasion resistant clear vinyl

Catalog #	Legend	Size	Color
58255	Caution w/ Blk/Ylw Stripes	3" x 60'	Blk/Ylw
58257	Blk/Ylw Stripes Only	3" x 60'	Blk/Ylw



## Stripe Anti-Skid Tape

- Rugged B-916 adhesive-backed polyester tape coated with durable aluminum oxide grit is ideal for indoor and outdoor use

Catalog #	Size	Color
78146	1" x 60'	Black/Yellow
78147	2" x 60'	Black/Yellow
78148	3" x 60'	Black/Yellow
78149	4" x 60'	Black/Yellow
78150	6" x 60'	Black/Yellow



## Safety Track® Resilient Tapes

- Kinder, gentler product without sacrificing performance
- Easily cleaned - can be mopped

Catalog #	Size	Color	Qty.
98455	4" x 60'	Black	1 roll
98459	4" x 60'	Gray	1 roll
98457	6" x 24"	Black	50 cleats



## Anti-Skid Floor Tape

- B-916 adhesive-backed polyester tape coated with aluminum oxide grit
- Bonds permanently to clean, dry floors both indoors and outdoors

Color	1" x 60'	2" x 60'	4" x 60'	6" x 60'	12" x 60'
Blk	78189	78190	78191	78193	78194
Rd	78197	78198	78199	-	-
Ylw	-	78091	78092	-	-
Wht	-	78187	-	-	-
Clear	-	78188	-	-	-



## Anti-Skid Hazard Cleats

- Durable grit-coated polyester diecuts
- Ideal for use on steps and in entryways

Catalog #	Legend	Size	Qty.
78160	Caution	6" x 24"	24
78163	Watch Your Step	6" x 24"	24



## Anti-Skid Diecut Cleats

- Durable grit-coated polyester diecuts

Catalog #	Legend	Size	Qty.
78161	Reflective Stripe	6" x 24"	24
78162	Photo-Lum Stripe	6" x 24"	24
78195	Black	6" x 24"	50
78196	Black	5.5" x 5.5"	50



## Anti-Slip Hazard Marking

- Made of B-819 matte anti-slip overlamine

Catalog #	Legend	Size	Color
92414	Caution	3" x 54'	Blk/Ylw
92415	Caution/Do Not Enter	3" x 54'	Blk/Ylw
92416	Caution/Watch Your Step	3" x 54'	Blk/Ylw
92417	Blank (striped only)	3" x 54'	Blk/Ylw



## Heavy Duty Anti-Skid Tapes

- Aggressive adhesive withstands harsh elements such as oil, fuel and grease
- Durable "high slip resistance" with deeply textured silicon carbide grit
- Ideal on loading docks, ramps and more

Catalog #	Size	Color
110020	2" x 60'	Black
110019	4" x 60'	Black
110018	6" x 60'	Black
110017	12" x 60'	Black



## Glow-In-The-Dark Cleats

- Durable B-916 grit-coated polyester diecuts offer photoluminescent safety marking

Catalog #	Description	Size	Qty.
99048	Tape	1" x 60'	1 roll
99049	Tape	2" x 60'	1 roll
99050	Tape	4" x 60'	1 roll
99052	Tape	6" x 60'	1 roll
99053	Tape	12" x 60'	1 roll
99054	Diecut cleat	6" x 24"	50 cleats
99055	Diecut cleat	6" x 24"	10 cleats



## ? BradyGlo™ Egress Marking

The 2012 versions of the International Building Code (IBC), International Fire Code (IFC) and the National Fire Protection Agency's (NFPA) 101 Life Safety Code contain new provisions for the means of egress in most new and pre-existing buildings with five or more stories.

Luminous (glow-in-the-dark) egress path markings are now required for the full width of every stair and handrail, among other markings. Brady offers a complete line of egress marking products that meet the current requirements for the 2012 means of egress regulations.



### BradyGlo™ Floor Tapes

- B-324 phosphorescent surface printed polyester
- Designed for safe Low Level Lighting egress pathway marking during power outages and emergency situations

Catalog #	Size	Color
76430	Striped Tape	2" x 15'
76431	Striped Tape	2" x 15'
76432	Solid Tape	2" x 15'
76433	Solid Tape	3" x 15'



### High Intensity Marking Tape

- Self Sticking Polyester in IBC/IFC compliant or NYC approved styles
- Ideal for marking steps and landings, door frames, and handrails

Catalog #	Size	Color
114634	IBC/IFC Marking Tape	1" x 50'
114636	IBC/IFC Anti-Slip Marking Tape	1" x 50'
81873	NYC Approved Marking Tape	1" x 50'
81729	NYC Approved Anti-Slip Tape	1" x 50'



### High Intensity Obstacle Tape

- Self Sticking Polyester in IBC/IFC compliant or NYC approved styles
- Clearly marks obstacles that protrude into the egress path

Catalog #	Style	Size
114635	IBC/IFC Compliant Obstacle Tape	1" x 50'
81869	NYC Approved Obstacle Tape	1" x 50'



### BradyGlo™ Arrow Tape

- Exceeds ASTM E 2072-00 standard
- Designed for safe low level lighting egress pathway marking during power outages and emergency situations

Catalog #	Style	Size
90971	V-Arrow Tape	2" x 15'
90972	V-Arrow Tape	3" x 15'
90973	Arrow Tape	2" x 15'
90974	Arrow Tape	3" x 15'
76430	Striped Arrow	2" x 15'

## ! OSHA Regulations

**OSHA 29 CFR 1910.1030 Bloodborne Pathogens:** Labels required for containers and shipments. Employers to post biohazard signs at the entrance to work areas.

**DOT 49 CFR 172.400(b) Labeling Requirements:** Labeling is required for infectious substances which meets one or more hazard classifications.

**UN2814 Infectious Substances:** Ebola virus defined as Category A infectious substance.

## Biohazard Identification

An essential step towards safety is the clear and instantly-readable identification of all biohazard areas and waste products.



### Biohazard Labels

- Labels effectively identify and warn of biohazard materials

Catalog #	Size	Qty
LH625E	4" x 2-7/8"	25/pk.



### Biohazard Waste Disposal Bags

- 3-mil polyethylene bags to package and dispose of biohazardous waste

Catalog #	Size	Qty
145586	16" x 14" x 36"	100/pk
145586	30" x 14" x 39"	100/pk



### Biohazard Tape

- Self-sticking vinyl tape is ideal for clearly identifying biohazard areas

Catalog #	Size	Qty
88051	2" x 108'	1 roll



Clearly identify hazardous areas with Brady Biohazard Signs available on page 61.

# Visual Workplace Marking

BradyID.com/visualworkplace



## Woven Barricade Tape

- Made of B-903 polypropylene
- Contains ultraviolet inhibitors for permanent outdoor marking

Catalog #	Legend	Size
91172	0.75" x 150'	Black/Yellow
91173	0.75" x 150'	Magenta/Yellow
91175	0.75" x 150'	Black/Red
91176	2" x 200'	Black/Yellow
91179	2" x 200'	Black/Red



## Reinforced Barricade Tape

- Provides fast, on-the-spot warning
- Standard package: one roll
- 250 lbs tensile strength

Catalog #	Legend	Size	Color
91100	Caution	3" x 500'	Blk/Ylw
91101	Caution Construction Area	3" x 500'	Blk/Ylw
91102	Caution Do Not Enter	3" x 500'	Blk/Ylw
91103	Caution Men Working	3" x 500'	Blk/Ylw
91104	Striped	3" x 500'	Blk/Ylw



## Re-Pulpable Barricade Tape

- Made of 100% strong woven, biodegradable cotton material
- Tape will break down if accidentally introduced into the system

2" x 150'	3" x 150'	Legend	Color
91082	91083	Caution	Blk/Ylw
91086	91084	Danger	Blk/Red
-	91087	Danger Do Not Enter	Blk/Ylw
-	91085	Danger Do Not Enter	Blk/Red



## Economy Barricade Tape

- Made of lightweight polyethylene
- Ideal for temporary use outdoors or permanent indoor warning

Catalog #	Size	Color
91237	1" x 500'	Blk/Ylw
91238	3" x 500'	Blk/Ylw



## Safety Color Code for Marking Physical Hazards

**1910.144(a):** Use yellow and black for physical hazards, red and white for fire protection equipment, black and white for traffic and housekeeping markings, magenta and yellow for radiation hazards.



Caution tape sold separately.

## Tape Tender

- Lightweight, indestructible construction
- Dispenses any 2" or 3" plastic tape rolls up to 1,000'
- Tape advances as needed using thumb
- Steel safety cutting blade cuts fast and smooth
- Patent No. 5,538,170

Catalog #	Legend	Qty.
72412	Tape Tender	1



## Barricade Tape

- Non-adhesive B-912 Polyethylene tapes provides fast, on-the-spot warning
- Use for temporary outdoor or permanent indoor use
- Lightweight tape can be tied, stapled or nailed to posts, fences or metal barricades
- Custom legends also available

3" x 200'	3" x 1000'	Legend	Color
91468	91462	Authorized Personnel Only	Blk/Ylw
91214	91454	(Blank - Blk/Yellow Stripes Only)	Blk/Ylw
91212	91450	Caution	Blk/Ylw
91447	91448	Caution Biohazard	Blk/Org
91469	91463	Caution Chemical Hazard	Blk/Ylw
91217	91453	Caution Construction Area	Blk/Ylw
91224	91451	Caution Do Not Enter	Blk/Ylw
91220	91458	Caution High Voltage	Blk/Ylw
91215	91452	Caution Men Working	Blk/Ylw
91227	91457	Caution Open Trench	Blk/Ylw
91470	91464	Caution Radiation Hazard	Mag/Ylw
91256	91257	Confined Space Do Not Enter	Blk/Ylw
91200	91201	Danger	Blk/Red
91213	91455	Danger	Blk/Ylw
91255	91456	Danger Asbestos Dust Hazard	Blk/Ylw
-	102823	Danger Asbestos Dust Hazard (w/Stripes)	Blk/Red/Wht
-	102822	Danger Confined Space (w/Stripes)	Blk/Red/Wht
102821	-	Do Not Enter (w/Stripes)	Blk/Red
102824	-	Do Not Enter	Blk/Red

# Visual Workplace Marking

BradyID.com/visualworkplace



## Biodegradable Flagging Tape

- Made of 70% wood fiber
- Non-toxic; will not harm wildlife, livestock or the environment
- Complete degradation will occur in 6-12 months depending on environment conditions

Catalog #	Legend	Size	Color
91090	Caution	3" x 150'	Blk/Rd
91091	Caution Do Not Enter	3" x 150'	Blk/Rd
91092	Caution Men Working Overhead	3" x 150'	Blk/Ylw
91088	Danger	3" x 150'	Blk/Ylw
91089	Danger Do Not Enter	3" x 150'	Blk/Ylw



## Identolite® Underground Warning Tape

- Made of heavy-duty B-720 polyethylene
- Tape is 4.0 mil. thick with a tough tensile strength of 1750 psi
- Easily identified - APWA (American Public Works Association) color coding
- Overcoated graphics provide long-lasting legibility and hold color values

Catalog #	Utility Class	Size	APWA Color
63009	Cable T.V.	6" x 1,000'	Orange
91295	Electric*	3" x 1,000'	Red
91296	Electric	6" x 1,000'	Red
91294	Gas	6" x 1,000'	Yellow
91299	Sewer	6" x 1,000'	Green
91297	Telephone	6" x 1,000'	Orange
63050	Reclaimed Water	6" x 1,000'	Purple
91298	Water	6" x 1,000'	Blue

\*Legend appears on one line



## Flagging Tape

- Flag boundary stakes, trees and hazardous areas
- Non-adhesive

Catalog #	Size	Color
58347	1.187" x 300'	Yellow
58342	1.187" x 300'	White
58343	1.187" x 300'	Green
58344	1.187" x 300'	Orange
58345	1.187" x 300'	Blue
58346	1.187" x 300'	Red
58348	1.187" x 150'	Fluor. Yellow
58349	1.187" x 150'	Fluor. Red
58351	1.187" x 150'	Fluor. Blue
58352	1.187" x 150'	Fluor. Orange
58353	1.187" x 150'	Fluor. Green
58354	1.187" x 150'	Fluor. Pink



## Detectable Identolite® Warning Tape

- Made of tough B-721 metal detectable polyester; foil is 4.5 mils
- Subsurface graphics seal the legend from acids, alkalis and soil substances
- Easily identified legend on APWA color-coded background
- Meets OSHA regulation covering location or underground utility lines

Catalog #	Utility Class	Size	APWA Color
91601	Electric	2" x 1,000'	Red
91606	Fiber Optic	2" x 1,000'	Orange
91600	Gas	2" x 1,000'	Yellow
91604	Sewer	2" x 1,000'	Green
91603	Water	2" x 1,000'	Blue



## Pennant Barricade Tape

- Tough and durable flag barricade can be used repeatedly
- Pennants are 18" x 18" triangles spaced evenly across tape

Catalog #	Legend
58388	83' Tape with 15 Pennants
58389	113' Tape with 25 Pennants



## Marking Flags

- Ideal for identifying possible hazards buried underground
- 4" x 5" flags attached to a 30", 15.5 gauge steel rod
- Custom legends available

Catalog #	Legend	Color	Qty.
98165	Buried Sewer Line	Blk/Grn	100
98166	Buried Cable	Blk/Rd	100
98167	Buried Water Line	Wht/Blu	100
98168	Buried Electric Line	Blk/Rd	100
98169	Buried Fiber Optic Cable	Blk/Org	100
98170	Buried Pipeline	Wht/Blu	100
98171	Buried Gas Line	Blk/Ylw	100
98172	(Blank)	Orange	100
98173	(Blank)	Red	100
98174	(Blank)	Yellow	100
98175	(Blank)	Blue	100
98176	(Blank)	White	100
98177	(Blank)	Green	100
98178	(Blank)	Fluor. Red	100



# Barricades

BradyID.com/visualworkplace



## Solid BradyLink Posts

- Polyethylene bases and tops; polystyrene posts
- Fillable non-conductive base
- Small: 2.5" dia. post; 40" tall; 14" dia. flat base
- Larger: 3" dia. post; 41" tall; 16" dia. dome base

Catalog #	Size	Color	Qty.
80937	Small Post	Black	1
80943	Small Post	Black	6
92116	Large Post	Black	1
92119	Large Post	Black	6
80938	Small Post	Yellow	1
80944	Small Post	Yellow	6
92118	Large Post	Yellow	1
92121	Large Post	Yellow	6
92117	Large Post	White	1
92120	Large Post	White	6

Base, top and c-hook included for each post.



## Striped BradyLink Posts

- Portable, non-rusting, polyethylene posts & chain
- Not intended to support heavy weight
- Small: 2.5" dia. post; 40" tall; 14" dia. flat base
- Larger: 3" dia. post; 41" tall; 16" dia. dome base

Catalog #	Size	Color	Qty.
<b>Non-Reflective</b>			
80940	Small Post	Blk/Ylw	1
80946	Small Post	Blk/Ylw	6
92122	Large Post	Blk/Ylw	1
92123	Large Post	Blk/Ylw	6
80947	Small Post	Ylw/Mag	6
92126	Large Post	Ylw/Mag	1
92127	Large Post	Ylw/Mag	6
<b>Reflective</b>			
80942	Sm Reflective	Blk/Ylw	1
80948	Sm Reflective	Blk/Ylw	6
92125	Lg Reflective	Blk/Ylw	6

Base, top and c-hook included for each post.



## BradyLink C-Hooks and Connecting S-Hooks

- C-hooks are ideal for temporarily attaching lengths of chain together
- S-hooks are installed at the top of posts to allow chain and s-hook to be attached to the post

Catalog #	Description	Color	Qty.
<b>C-Hooks for posts</b>			
92011	C-Hook	Black	1
92012	C-Hook	Yellow	1
92010	C-Hook	White	1
<b>S-Hooks for chain</b>			
78259	2" S-Hook	Black	36
78257	2" S-Hook	Yellow	36
78258	2" S-Hook	White	36

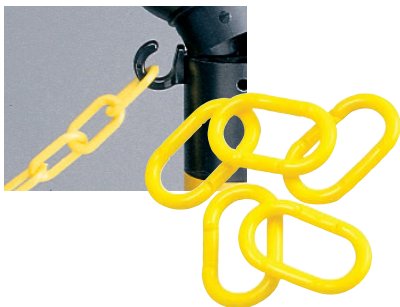

## BradyLink Links

- Polyethylene chain for indoor use only
- Link design prevents kinking

Catalog #	Size	Color	Qty
78248	2" Links	Black	36
78246	2" Links	Yellow	36
78247	2" Links	White	36

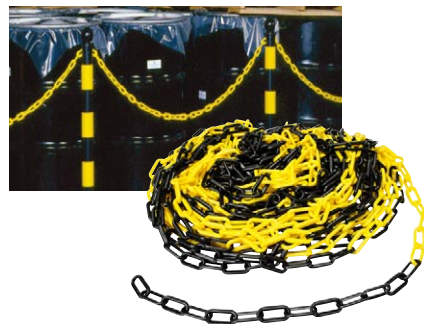

## BradyLink Chain

- Polyethylene chain for indoor use only
- Link design prevents kinking

Catalog #	1.5" x 100'	2" x 100'	3" x 100'
Yellow	78234	78238	37860
Black/Yellow	-	78254	37864
White	78235	78239	37861
Black	-	78268	-
Orange	-	78241	-
Yellow/Magenta	-	-	37865



## Post Sign Adapter

- Polyethylene chain for indoor use only
- Adaptor locks in place on top of BradyLink Warning Posts

Catalog #	Size	Color	Qty
80958	5" x 1.75"	Black	1
80960	5" x 1.75"	Black	6
92135	6" x 2"	Black	1
92137	6" x 2"	Black	6
80959	5" x 1.75"	Yellow	1
80961	5" x 1.75"	Yellow	6
92134	6" x 2"	Yellow	1
92136	6" x 2"	Yellow	6



## Bradycone™ Warning Cones

- Made of high impact, weather-resistant warning cones stack for easy storage

Catalog #	Description	Size
77200	Wet Floor	Yellow 25"
77202	Wet Floor	Yellow 35"
77201	Safety First	Yellow 25"
77203	Safety First	Yellow 35"
77198	Blank	Yellow 25"
77205	Blank	Yellow 35"
77199	Blank	Orange 25"
77204	Blank	Orange 35"



## Handy Cone™ Floor Signs

- Collapsible, spring-loaded, pyramid-shaped signs set up in seconds
- Stored in a 2" diameter tube

Catalog #	Legend	Size	Qty.
47380	Warning-People Working	31"	1
47382	Caution - Wet Floor/Piso Mojado	31"	1
47372	Caution - Wet Floor	18"	1



## Bradycone™ Accessories

- Accessories to complete your Bradycone™ Warning System

Catalog #	Description	Size
77210	Lock-in-Frame (Face: 8-1/4" x 8-1/4")	10" x 10"
77207	Lock-in-Chain (locks directly into cone)	20"
77228	Weight Ring	7 lbs
77208	Weight Ring	9 lbs



## Floor Stands

- Made of durable Polystyrene Plastic
- Printing appears on both panels

Catalog #	Legend	Size
47243	Caution Tripping Hazard	12"x20"
47239	Danger Persons Working Above	12"x20"
47240	Dangers Persons Working Below	12"x20"
47251	Notice Restroom Closed For Cleaning	12"x20"



## Bradycone™ Picto Labels

- Self-sticking labels apply to the Lock-in-Frame (sold separately)

Catalog #	Legend	Size	Qty
94917	Falling Ice	8.25" x 8.25"	1
77221	Electrical Hazard	8.25" x 8.25"	1
77224	No Entry Construction	8.25" x 8.25"	1
77217	No Smoking	8.25" x 8.25"	1
77219	Out Of Service	8.25" x 8.25"	1
77227	Restroom Closed	8.25" x 8.25"	1
77216	Slippery	8.25" x 8.25"	1
77226	Watch Your Step	8.25" x 8.25"	1
77210	Lock-in-Frame (Face: 8-1/4" x 8-1/4")	10" x 10"	1



## Heavy Duty Floor Stands

- Alert employees and visitors of potential floor hazards
- Made of heavy-duty polypropylene
- Wording appears on both panels

Catalog #	Legend	Height
104808	Blank	24.5"
104810	Caution	24.5"
104811	Closed	24.5"
104809	Wet Floor	24.5"

## Reversible Floor Stands

- Made of lightweight corrugated polypropylene material
- Printed on both sides - inside and out
- 12" x 20" when closed



# Barricades and Mirrors

BradyID.com/visualworkplace



## Traffic Cones

- Meets MUTCD specifications
- Vinyl construction assures flexible, yet rugged durability

Catalog #	Description	Size	Qty.
80111	18" Cone	18"	1
80112	24" Cone	24"	1



Convex

Half Dome

## Safety Mirrors

- Impact-resistant plastic mirrors improve visibility and safety by providing a wide or field of vision
- Mounting hardware included

Catalog #	Description	Size	Qty.
86340	Outdoor Convex	26"	1
86341	Indoor Convex	18"	1
86344	Full Dome 360°	48"	1
86342	Half Dome 180°	18"	1
86343	Quarter Dome 90°	18"	1



## Bradystake™ Warning Stakes

- Blank stakes with no sign assembly
- Rugged and flexible reinforced polymer; when driven over, they bend, not break.

Catalog #	Color	Color	Size
<b>Stakes with Points</b>			
96950	With Points	Orange	3.75" x 66"
96951	With Points	Yellow	3.75" x 66"
96952	With Points	Blue	3.75" x 66"
96953	With Points	Green	3.75" x 66"
96954	With Points	White	3.75" x 66"
96955	With Points	Red	3.75" x 66"
<b>Stakes without Points</b>			
96920	Without Points	Orange	3.75" x 66"
96921	Without Points	Yellow	3.75" x 66"
<b>Reflective Stakes (Striped)</b>			
96922	Reflective	Org/Wht	3.75" x 66"
96923	Reflective	Blk/Ylw	3.75" x 66"



## Traffic Cones Signs

- Easy to install plastic sign fits any standard traffic cone or delineator
- Legend on one side only

Catalog #	Legend	Size	Qty.
80117	Do Not Enter	10.5" x 12.75"	1
80118	Wet Floor	10.5" x 12.75"	1



## Tensabarrier™ Barricades

- 40" post with 14" dia. (26lbs) base
- Pull-out belt is 7.5' long

Catalog #	Legend
80125	Post w/ Black/White Stripe Belt
80127	Post w/ Black/Yellow "CAUTION-DO NOT ENTER" Belt
58413	Wall-mount End



## Bradystake™ Warning Stake Labels

- Made of B-302 self-sticking polyester
- 1" blank area at bottom will accommodate separate label with company name and telephone number
- Avoid custom lead times by ordering these stock labels with Blank Bradystake™ Warning Stakes (sold separately)

Catalog #	Legend	Size
85406	Caution Gas Pipeline	14" x 3"
85551	Warning Natural Gas Pipeline	14" x 3"



## Tensabarrier™ Signs

- Made of durable plexiglass
- 11" x 7" sign feature white letters on black background

Catalog #	Legend
80129	Please Wait Here For Next Available Teller
80130	Please Wait Here For Next Available Clerk
80131	Please Wait Here For Next Available Agent

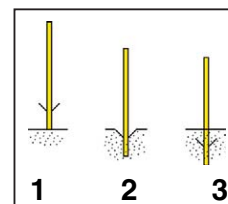

## Bradystake™ Anchors

- Made of resilient, long-lasting spring steel
- For added stability in loose and sandy soil
- Catches soil around the stake preventing unauthorized removal
- As a custom order, anchors can be attached to Bradystake™ Warning Stakes at the factory for quick field installation

Catalog #	Legend	Qty
97084	Bradystake™ Anchors	1



## Visual Workplace Foundations Training Kit

- A comprehensive foundation in core visual workplace concepts, principles, and tools for both novices and experts
- Produced by Dr. Gwendolyn D. Galsworth, PhD
- Covers visual techniques and best practices that are critical to any lean, 5S or kaizen initiative
- See 150 examples and listen to actual users insights and experiences
- Kit Contents:
  - 6 DVD Set (4 modules + overview)
  - 2-CD Audio Set includes additional coaching for managers and trainers
  - 1 Handbook (230 pages with 200+ photos)
  - 1 Tote Bag

Catalog #	Description
113238	Complete Training Kit
113240	2-CD Audio Set
113239	1 Associate Handbook
113244	1st DVD: Basics of Visual Thinking

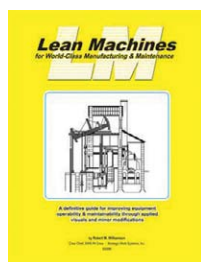

## Lean Machines for World-Class Manufacturing & Maintenance

- Written by Robert M. Williamson
- Explains how visual systems can be applied to simplify the interactions between people and machines
- Learn how visual controls improve equipment performance, simplify routine maintenance, plus reduce equipment training time

Catalog #	Description
113242	Lean Machines Book

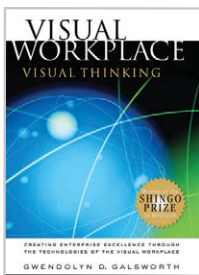

## Visual Workplace, Visual Thinking Book

- Written by Dr. Gwendolyn Galsworth, PhD, this book positions workplace visuality as a powerful partner on your company's lean journey.
- Provides concepts, principles, frameworks, and models for creating a fully-functioning visual enterprise through visual workplace technologies: Visual Order, Visual Standards, Visual Displays, Visual Metrics, Visual Problem Solving, Visual Controls, Visual Pull Systems, and Visual Guarantees (poka yoke devices).
- 200+ pages, with 200 full-color photographs and 50 charts.

Catalog #	Description
113241	Visual Workplace, Visual Thinking Book

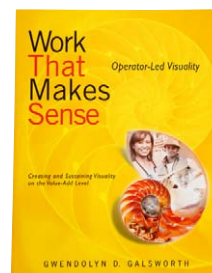

## Work That Makes Sense Book

- At last, a book that explains workplace visuality as a comprehensive strategy for eliminating abnormalities, sustaining lean gains, and aligning and unifying the work culture. Written by Dr. Gwendolyn Galsworth, PhD, Work That Makes Sense is a complement to her Visual Workplace, Visual Thinking book which shows you how to implement, coach, support, and sustain visual inventiveness on the operator-level.

Catalog #	Description
142132	Work That Makes Sense Book



## Visual Systems Presentation CD-Rom

- Companion to Lean Machines book
- Powerpoint slides provide access to the many different full-color examples of visual systems referenced in the book
- Handout materials and facilitator's notes can also be printed from the CD-ROM for use in the classroom

Catalog #	Description
113243	Visual Systems Presentation CD

**BradyID.com**

Over 30,000 products now at your fingertips.

Visit the new BradyID.com, your online resource for:

- Full Product Offerings
- Product Info & Literature
- Product Demos
- Creat Custom Products
- e-Learning Training Courses
- Whitepapers
- Webinars
- And so much more!





## Metal Ball Seals

- Stock Metal Ball Seals are supplied with consecutive numbering (factory chooses starting number) and the word "SEALED" already embossed
- Choose from seals with or without a rolled edge to help prevent accidental cuts

Catalog #	Description	Qty.
95197	Metal Ball Seals	100
95198	Rolled Edge Metal Ball Seals	100

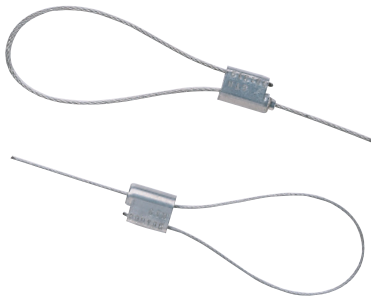

## Cable Lock Seals

- Heavy steel seals have a steel head with 6 serialized numbers for inventory or tracking
- Seals have imprinted letters STN
- Factory chooses the starting number

Catalog #	Description	Tensile Strength	Qty.
95166	12" x 1/16"	480 lbs.	100
95167	12" x 3/32"	800 lbs.	100



## Metal Seals

- 12" wire with pre-fitted lead seals fit easily around pipes or valves
- Use with Hand Sealing Press

Catalog #	Material	Size	Qty.
23301	Copper	12" length 31 gauge 7/16" dia.	250
23302	Monel Lead	12" length 31 gauge 7/16" dia.	250



## Stock Plastic Truck Seals

- Deters entry, yet easily removed
- Tamper-resistant truck seals are embossed with the wording "Sealed" and are consecutively numbered
- Ships in mats of ten for convenience and better accountability - 100 seals total in package.

Catalog #	Size	Color	Qty.
95193	7-1/2"	Blue	100
95195	7-1/2"	Red	100
95196	7-1/2"	Yellow	100
133487	7-1/2"	Green	100
133488	7-1/2"	Orange	100



## Hand Sealing Press

- Quickly and permanently crimp your lead seals with Brady's own hand sealer.

Catalog #	Material	Qty.
23300	Hand Sealing Press	1

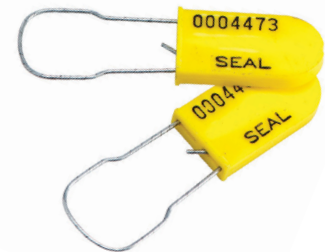

## Padlock Plastic Seals

- Tamper evident and corrosion resistant
- Seals made of durable polypropylene and available with stainless steel wire hasps
- Seal body will blush if tampered with
- Seals are heat stamped with seven-digit sequential number that are factory specified
- Standard seals are stamped "SEAL"

Catalog #	Color	Qty.
95168	Black	100/pk*
95174	White	100/pk*
95173	Red	100/pk*
95172	Orange	100/pk*
95170	Gray	100/pk*
95171	Green	100/pk*
95169	Blue	100/pk*
95175	Yellow	100/pk*

\* Minimum order: 5pks





## Pull-Tite Seals

- Breaking strength of 10-14 pounds
- Pull-Tite Seals are one of the few security seals approved for use by Underwriter's Laboratories for fire extinguishers and safety doors
- Ideal for use with courier pouches, canisters or cabinets that contain valuables or sensitive documents
- Pull-Tite Seals are embossed "SEALED DO NOT REMOVE"

Catalog #	Size	Color	Qty.
<b>UL approved for fire extinguishers and safety doors</b>			
95141	9"	Black	100
95143	9"	Blue	100
95144	9"	Green	100
95150	9"	Red	100
95155	9"	Yellow	100
<b>Non-UL approved</b>			
133481	9"	Blue	100
133482	9"	Green	100
133483	9"	Red	100
133484	9"	Yellow	100
133485	9"	Orange	100
133486	9"	White	100

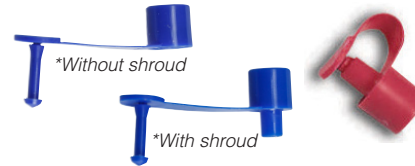

## Ring-Loc Drum™ Seals

- Specifically designed to ensure fiber drum integrity
- Avoid product contamination
- Available in two materials:  
nylon - which affords greater strength  
polypropylene - which will blush if tampered with
- Two styles - with or without shroud
- Seals are applied with two fingers and removed with a simple cutting tool

Catalog #	Description	Color	Qty.
95158	Nylon w/ Shroud	Blue	100
95159	Nylon w/o Shroud	Blue	100
95161	Nylon w/ Shroud	Red	100
95160	Nylon w/o Shroud	Red	100
95162	Polypropylene w/ Shroud	Blue	100
95163	Polypropylene w/o Shroud	Blue	100
95164	Polypropylene w/ Shroud	Red	100
95165	Polypropylene w/o Shroud	Red	100



## Simulated Surveillance Camera

- Deter theft and vandalism. Outwardly, these simulated surveillance cameras are indistinguishable from "live" cameras.
- A commercial quality high impact styrene camera housing for indoor or outdoor use
- Installs in minutes requiring no wiring

Catalog #	Description
95140	Stationary Simulated Surveillance Camera



## Security Tyvek Wristbands

- Tamper-resistant to ensure security
- Tyvek Wristbands are an economical way to keep track of personnel, patients or visitors
- Made of ultra-strong, waterproof Tyvek, these 1" wide wristbands will not tear or stretch
- Secure adhesive closure that can not be reused
- All wristbands are consecutively numbered (factory specified)

Catalog #	Color	Size	Qty
95097	Red	1"	500
95101	Pink	1"	500
95099	Yellow	1"	500
95102	Orange	1"	500
95098	Purple	1"	500
95100	Blue	1"	500
95103	Green	1"	500



# Security Badges

BradyID.com/s34



## SecurAlert™ Clip-On Badges

- Low cost clip-on alternative to self-adhesive badges
- 3" x 3" slotted cards
- 500 front & back badge pars per pack

	Visitor	Contractor	Temporary
<b>Badge expires after 1 day</b>			
Red	95643	95653	95663
Blue	95644	95654	95664
Yellow	95645	95655	95665
Green	95646	95656	95666
White	95647	95657	95667
<b>Badge expires after 1 week</b>			
Red	95648	95658	95668
Blue	95649	95659	95669
Yellow	95650	95660	95670
Green	95651	95661	95671
White	95652	95662	95672



## Retractable Badge Holder

- Attach to belt or clothing
- Retractable Badge Holder with clip is the ideal alternative to bull dog clips which may damage clothing
- Clip attaches to belt or pocket while the heavy-duty nylon cable with fastener attaches to badge

Catalog #	Description	Color	Qty.
95071	Retractable Holder	Blue	1
95072	Retractable Holder	Red	1
95073	Retractable Holder	White	1
95074	Retractable Holder	Gray	1
95075	Retractable Holder	Black	1

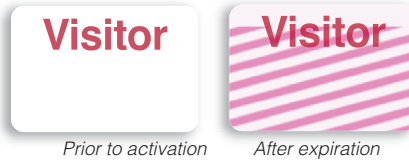

## One Step SecurAlert™ Badges

- Pre-assembled for your convenience
- Activated by removing the liner between the "front" badge and the "back" badge
- Badges expire after 24 hours
- 500 front & back badge parts per pack

Catalog #	Legend	Size	Qty.
95635	Visitor	2" x 3"	500
95636	Contractor	2" x 3"	500



## Lanyards

- Constructed of durable cloth and can be reused
- 19" lanyards have a snap-swivel hook and adjustable bead for securing lanyard

Catalog #	Color	Qty.
95090	Blue	1
95091	Green	1
95092	Orange	1
95093	Red	1
95094	White	1

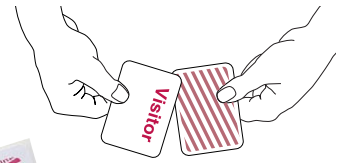

## SecurAlert™ Adhesive Badges

- Activate expiration by applying the "front" badge to the "back" badge.
- Badges expire after 24 hours from activation
- 500 front & back badge parts per pack

Catalog #	Legend	Expires In	Qty.
95688	Visitor	24 hours	500
95689	Contractor	24 hours	500
95690	Temporary	24 hours	500
95673	Visitor	1 week	500
95674	Contractor	1 week	500
95675	Temporary	1 week	500

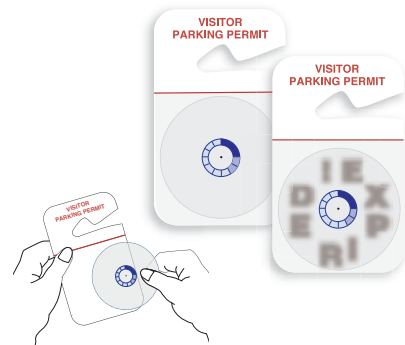

## Self-Expiring Parking Permits

- Temporary parking permits expire during the day by progressively revealing the letters E-X-P-I-R-E-D.
- Expiration process starts once the self-adhesive cover is applied

Catalog #	Legend	Color	Qty.
<b>Red for Hot Weather Over 80°F/25°C</b>			
95677	Visitor	5" x 3"	500
95680	Temporary	5" x 3"	500
<b>Blue for Moderate Weather 50°F/10°C to 80°F/25°C</b>			
95678	Visitor	5" x 3"	500
95681	Temporary	5" x 3"	500
<b>Purple for Cold Weather under 50°F/10°C</b>			
95679	Visitor	5" x 3"	500
95682	Temporary	5" x 3"	500

## Parking Permits



Self-Adhesive Vinyl Windshield Decals

Catalog #	Color	Sequence	Size	Qty.
95199	Blue	001-100	3" x 3"	100
96230	Blue	101-200	3" x 3"	100
96231	Blue	201-300	3" x 3"	100
96232	Blue	301-400	3" x 3"	100
96233	Blue	401-500	3" x 3"	100
95200	Red	001-100	3" x 3"	100
96234	Red	101-200	3" x 3"	100
96235	Red	201-300	3" x 3"	100
96236	Red	301-400	3" x 3"	100
96237	Red	401-500	3" x 3"	100



Rearview Mirror Decals

Catalog #	Color	Sequence	Size	Qty.
95203	Blue	001-100	2" x 1.5"	100
96238	Blue	101-200	2" x 1.5"	100
96239	Blue	201-300	2" x 1.5"	100
96240	Blue	301-400	2" x 1.5"	100
96241	Blue	401-500	2" x 1.5"	100
95204	Red	001-100	2" x 1.5"	100
96242	Red	101-200	2" x 1.5"	100
96243	Red	201-300	2" x 1.5"	100
96244	Red	301-400	2" x 1.5"	100
96245	Red	401-500	2" x 1.5"	100



Self-Adhesive Vinyl Bumper Decals

Catalog #	Color	Sequence	Size	Qty.
95209	Blue	001-100	3.5" x 2"	100
95207	Blue	001-100	4.75" x 2.74"	100
96254	Blue	101-200	3.5" x 2"	100
96246	Blue	101-200	4.75" x 2.74"	100
96255	Blue	201-300	3.5" x 2"	100
96247	Blue	201-300	4.75" x 2.74"	100
96256	Blue	301-400	3.5" x 2"	100
96248	Blue	301-400	4.75" x 2.74"	100
96257	Blue	401-500	3.5" x 2"	100
96249	Blue	401-500	4.75" x 2.74"	100
95210	Red	001-100	3.5" x 2"	100
95208	Red	001-100	4.75" x 2.74"	100
96258	Red	101-200	3.5" x 2"	100
96250	Red	101-200	4.75" x 2.74"	100
96259	Red	201-300	3.5" x 2"	100
96251	Red	201-300	4.75" x 2.74"	100
96260	Red	301-400	3.5" x 2"	100
96252	Red	301-400	4.75" x 2.74"	100
96261	Red	401-500	3.5" x 2"	100
96253	Red	401-500	4.75" x 2.74"	100



Rearview Mirror Hanging Tags

Catalog #	Color	Sequence	Size	Qty.
95201	Blue	001-100	2.75" x 4.75"	100
96262	Blue	101-200	2.75" x 4.75"	100
96263	Blue	201-300	2.75" x 4.75"	100
96264	Blue	301-400	2.75" x 4.75"	100
96265	Blue	401-500	2.75" x 4.75"	100
96266	Blue	501-600	2.75" x 4.75"	100
96267	Blue	601-700	2.75" x 4.75"	100
96268	Blue	701-800	2.75" x 4.75"	100
96269	Blue	801-900	2.75" x 4.75"	100
96270	Blue	901-1000	2.75" x 4.75"	100
95202	Red	001-100	2.75" x 4.75"	100
96271	Red	101-200	2.75" x 4.75"	100
96272	Red	201-300	2.75" x 4.75"	100
96273	Red	301-400	2.75" x 4.75"	100
96274	Red	401-500	2.75" x 4.75"	100
96275	Red	501-600	2.75" x 4.75"	100
96276	Red	601-700	2.75" x 4.75"	100
96277	Red	701-800	2.75" x 4.75"	100
96278	Red	801-900	2.75" x 4.75"	100
96279	Red	901-1000	2.75" x 4.75"	100



Rearview Mirror Hanging Tags

Catalog #	Color	Sequence	Size	Qty.
95205	Blue	001-100	4.75" x 2"	100
96280	Blue	101-200	4.75" x 2"	100
96281	Blue	201-300	4.75" x 2"	100
96282	Blue	301-400	4.75" x 2"	100
96283	Blue	401-500	4.75" x 2"	100
96284	Blue	501-600	4.75" x 2"	100
96285	Blue	601-700	4.75" x 2"	100
96286	Blue	701-800	4.75" x 2"	100
96287	Blue	801-900	4.75" x 2"	100
96288	Blue	901-1000	4.75" x 2"	100
95206	Red	001-100	4.75" x 2"	100
96289	Red	101-200	4.75" x 2"	100
96290	Red	201-300	4.75" x 2"	100
96291	Red	301-400	4.75" x 2"	100
96292	Red	401-500	4.75" x 2"	100
96293	Red	501-600	4.75" x 2"	100
96294	Red	601-700	4.75" x 2"	100
96295	Red	701-800	4.75" x 2"	100
96296	Red	801-900	4.75" x 2"	100
96297	Red	901-1000	4.75" x 2"	100

**Custom permits are available with your own logo, color and custom text.**



# Dispensers

BradyID.com/s34



## Large Capacity Eye Protection Dispenser

- Clear acrylic unit can be wall or table mounted
- Holds approximately 35 pairs

Catalog #	Description	Size
PD701E	Dispenser	12-1/4"x18"x9-1/4"



## Eye Wash Station

- Station includes two 32 oz. bottles for immediate eye flushing
- Wall mount or table top use

Catalog #	Size	Size
EW1	Eye Wash Station	16" x 12" x 4"



## Safety Glasses Holder

- This compact unit holds 4-6 pairs of glasses
- Wall or table mount

Catalog #	Description	Size
2011L	Holder w/ cover	3" x 9" x 6" with 6" high backplate
2011	Holder w/o cover	3" x 9" x 6" with 6" high backplate



## Eye Wash Station

- Proper usage instructions silk-screened on door
- Holds 32 oz. bottle (not included)
- Wall or table mount

Catalog #	Description	Size
PD997E	Double Bottle Station	10" x 10-1/4" x 7"
PD995E	Single Bottle Station	10" x 6-1/4" x 7"



## Divided Eyewear Dispensers

- White table top dispenser with clear dust cover allows you to keep two different style of eyewear
- Holds approx. 20 pairs

Catalog #	Size	Size
PD264E	Divided Eyewear	11-1/2" x 15-3/8" x 9"



## Towelette Dispenser

- Top loading dispenser has an overflow tray at the bottom
- Table top or wall mount use
- Holds approx. 300 towelettes

Catalog #	Size	Size
LCDISP	Towelette Dispenser	9-3/4" x 7-3/4" x 5", 12" backplate



## Deluxe Visitor Spec

- Tough clear acrylic dispensers have a bottom door that keeps glasses in and folds down for easy dispensing
- Wall mount dispenser holds approx. 20-25 glasses

Catalog #	Description	Size
MVSD	Deluxe Visitor Spec	18"x8"x4"
MVSDL	Clear Deluxe Visitor Spec w/cover	18"x8"x4"
MVSDO	Orange Deluxe Visitor Spec	18"x8"x4"
MVSDG	Green Deluxe Visitor Spec	18"x8"x4"
MVSDM	Mirrored Deluxe Visitor Spec	18"x8"x4"



## Economy Visitor Spec

- Economy dispenser holds approx. 20 glasses
- Table top or wall mount use

Catalog #	Description	Size
EHMVSD	Economy Dispenser	17-1/4"x8"x4"



## Large Capacity Ear Plug

- Removable inner slanted shelf
- Holds 200 disposables
- Wall or table mount

Catalog #	Description	Size
PD439G	Dispenser	13" x 12" x 8"



## Ear Plug Dispenser

- Removable inner slanted shelf
- Holds 100 to 150 pairs
- Wall or table mount

Catalog #	Description	Size
EPD	Ear Plug Tray	13" x 6" x 8"



## Ear Plug Dispenser

- White acrylic dispenser with front graphic, draws attention to the need to wear ear protection
- Holds approx. 100 pairs
- Wall mount or table top use

Catalog #	Size	Size
EPDISP	Ear Plug Dispenser	9-3/4" x 7-3/4" x 5", 12" backplate



## Compact Ear Plug Dispenser

- Cushioned foam bottom
- Wall or table mount

Catalog #	Description	Size
2019L	Dispenser w/cover	3" x 9" x 6" with a 6" high backplate
2019	Dispenser w/o cover	3" x 9" x 6" with a 6" high backplate



## Divided Hearing Protection Dispenser

- Dispenser has two sections in order to dispense two different kinds of hearing protection
- Table top use only

Catalog #	Description	Size
PD265E	Divided Hearing Protection	11-1/2"x15-3/8"x9"



## Triple Ear Plug Dispenser

- Blue acrylic dispenser tray allows your employees three choices for best fit
- Each compartment holds approx. 50 pairs
- Table top or wall mount use

Catalog #	Size	Size
PD244E	Ear Plug Tray	10" x 12-5/8" x 6-3/4"



# Dispensers

BradyID.com/s34



## Head Wear Dispensers

- Middle divider makes it easy to separate
- White acrylic with see-through lid
- Table top only

Catalog #	Description	Size
PD240E	Hairnets	7-1/2" x 10" x 6"



## Head Wear Dispensers

- Middle divider makes it easy to separate
- White acrylic with see-through lid
- Table top only

Catalog #	Description	Size
PD241E	Dispenser	11-1/2" x 15-3/8" x 9"



## Bouffant Cap / Beard

- Table or wall mount for easy access

Catalog #	Description	Size
PD524E	Bouffant Cap Dispenser	14" x 12" x 8"
PD325E	Beard Cover Dispenser	14" x 12" x 8"



## Glove Dispensers

- The single, double and triple units are all vertically mounted on either wall or counter

Catalog #	Description	Size
GD01	Single	5" x 10.93" x 4.12"
GD02	Double	10" x 10.375" x 4.12"
GD03	Triple	15" x 10.375" x 4.12"



## Deluxe Glove Dispenser

- The deluxe triple is mounted horizontally and allows you to change one box without affecting the others

Catalog #	Description	Size
GD03DL	Deluxe Glove Dispenser	11-13/16" x 20" x 4"



## PPE Dispensers

- Store bouffants, booties, gloves, ear plugs, etc. dispensed through 4" round front opening
- Wall or table mount

Catalog #	Size	Size
DPE	PPE Dispenser	10" x 10" x 10"



## Shoe Cover Dispenser

- Holds over 50 pairs of poly shoe covers
- Table top or wall mount

Catalog #	Description	Size
PD322E	Shoe Cover Dispenser	14" x 12" x 8"



## Dust Mask Dispenser

- Unique cutout design that allows you to reach in the opening to easily remove
- Holds more than 30 masks

Catalog #	Description	Size
M420	Dust Mask Dispenser	12-1/2" x 6" x 6"



## Finger Cot Dispensers

- White and clear acrylic dispenser with lid helps keep your finger cots clean and ready to use
- Wall or table mount

Catalog #	Size	Size
FC1	Finger Cot Dispenser	13" x 6" x 8"

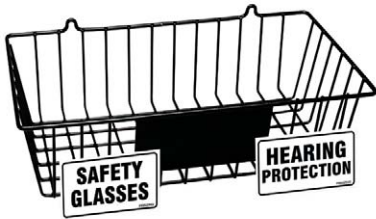

## PPE Storage Rack

- Black PVC coated steel rack can hold a variety of items
- Includes one "Safety Glasses" label and one "Hearing Protection" label
- Wall mount or table top use

Catalog #	Size	Size
PD001E	Storage Rack	4-1/2" x 15-3/8" x 8-3/4"



## PPE Foam-lined Dispenser

- Foam bottom
- Wall or table mount

Catalog #	Description	Size
MPPE	Misc. PPE Dispenser	9-1/2" x 11-1/2" x 9-1/2"



## Clear Acrylic Dispenser Tray

- Use on tabletop or mount on wall

Catalog #	Description	Size
PD205A	Dispenser tray	3" x 9" x 6" with a 6" high backplate
PD206A	Tray with lid (not shown)	3" x 9" x 6" with a 6" high backplate



## Ear Plug Tray

- Clear acrylic dispenser tray holds a box of your preferred PPE supplies
- Front tray catches spills and protects product dispenser or packaging
- Table top or wall mount use

Catalog #	Size	Size
PD228E	Ear Plug Tray	10-5/8" x 10-5/8" x 10-5/8"



## Towelette Tray

- Attention grabbing red fluorescent acrylic tray holds towelette boxes or other miscellaneous small, frequently used dispenser style boxes
- Wall mount or table top use

Catalog #	Size	Size
PD256E	Towelette Tray	4-1/2" x 6-1/4" x 5-1/4"



## PPE Specific Safety Signs

Brady's wide variety of PPE specific safety signs should be used to clearly mark where PPE equipment is required.

View page 143 for all PPE safety signs



# Portable Printers

BradyID.com/s34

## Portable Printer Comparison Guide

Use the following comparison guide to quickly see which printer best fits your application needs. Then turn to the following pages to find out more about each printer, compatible materials and print ribbons.



**BMP®21-PLUS Label Printer**  
See page 290



**BMP®41 Label Printer**  
See page 294



**BMP®53 Label Printer**  
See page 300

Printer Specifications	BMP®21-PLUS Label Printer	BMP®41 Label Printer	BMP®53 Label Printer
<b>Max Labels Per Day</b>	Average 100 labels/day	Average 250 labels/day	Average 500 labels/day
<b>Print Resolution</b>	203 dpi	300 dpi	300 dpi
<b>Print Technology</b>	Thermal transfer	Thermal transfer	Thermal Transfer
<b>Print Speed</b>	10mm/sec (0.4 in/sec)	133mm/sec (1.3in/sec)	25.4mm/sec (1/sec)
<b>Tape Widths (inches)</b>	Various sizes from 0.250" to 0.750"	Various sizes from 0.235" to 1.0"	Various sizes from 0.235" to 1.50"
<b>Tape Widths (mm)</b>	Various sizes from 6.4 mm to 19.1 mm	Various sizes from 5.969 mm to 25.4 mm	Various sizes from 6.4 mm to 38.1 mm
<b>Max Label Width</b>	0.75" (19.1 mm)	1.00" (25.4mm)	1.50" (38.1mm)
<b>Max Print Width</b>	0.63" (16 mm)	0.96" (24.4 mm)	1.44" (36.6 mm)
<b>Memory</b>	16MB, 10 Labels (2MB available for storage)	48 MB / Up to 25,000 Labels	48 MB / Up to 25,000 Labels
<b>Materials Supported</b>	M21- Series Cartridges 70+ Stock Parts	M-, MC-, MC1- Series Cartridges (1.00" and 0.75" height only) 100+ Stock Parts	M-, MC-, MC1- Series Cartridges (all sizes) 140+ Stock Parts
<b>Continuous vs Die Cut Labels</b>	Continuous Labels Only	Continuous and die cut labels	Continuous and die cut labels
<b>Connectivity Options</b>	Not Applicable	Yes	Yes
<b>PC Connectivity</b>	No	USB	USB, WiFi, LAN
<b>Software Compatibility</b>	No	Optional through USB	LabelMark® / CodeSoft™ Software
<b>File Transfer from PC to printer</b>	No	Yes - with Labelmark® Software	Yes, with Labelmark® Software
<b>Wireless Connectivity</b>	No	No	Yes
<b>Stand Alone Printing</b>	Yes	Yes	No
<b>Color Capability</b>	Single print color on a label	Single print color on a label	Single print color on a label
<b>Keyboard</b>	ABC or Cyrillic	QWERTY	Not Applicable
<b>Backlit Screen</b>	2" x 1", user adjustable backlit	2.5" x 1.4", user adjustable backlit	Not Applicable
<b>Text Sizes</b>	6-40 pt with Autosizing	4 to 103pt + autosizing	4 to 103pt + autosizing
<b>Multi-Line Print</b>	Yes	Yes	Yes
<b>Print Rotation</b>	No	Yes	Yes
<b>Serialization</b>	Yes	Yes	Yes
<b>Barcode</b>	39 and 128	39 and 128	39 and 128
<b>Symbols Categories</b>	104	450	450
<b>Portability</b>	Yes	Yes	Yes
<b>Label Types or Application Functions</b>	PermaSleeve® Heat Shrink Tubing, Permanent Polyester, Self-laminating Vinyl, Clear Polyester, High Performance Polyester, Nylon Cloth, Indoor/Outdoor Vinyl, Polypropylene	Adhesive Polyester, PermaSleeve® Heat Shrink Tubing, Polypropylene Tags, Self-laminating Vinyl, Metalized Polyester Ultra Aggressive Polyester, Repositional Vinyl Cloth, Nylon Cloth, Reflective Tape, Indoor/Outdoor Vinyl,	Polyester, Polyethylene Tag, Permasleeve® Heat Shrinking Tube, Tamper-Evident Vinyl, Polypropylene Tag, Permanent Polypropylene, Self-Laminating vinyl, Metalized Polyester, Self-Laminating Polyester, Staingerbondz™ Labels, Tissue Cassette Polyester, Ultra aggressive Polyester, High Performance Polyester, Freezerbondz™ Labels, Repositionable Vinyl Cloth, Reflective Tap, Indoor/Outdoor Vinyl
<b>Applications</b>	Basic labels for Wire and Cable ID, Datacomm and AV Labeling, Inside-panel Component Labeling, and General Industrial Labels for Maintenance, Production and Visual Workplace/Lean 5S.	Basic and Die Cut labels for Wire and Cable ID, Datacomm and AV labeling, Electrical ID, Panel ID, Product ID, Facility ID, Safety and Maintenance, General ID	Data Communications Labeling, Facility, Safety & Maintenance Identification, General & Industrial Labeling, Laboratory Identification, Panel Identification, Security Identification, Wire & Cable Marking
<b>Power Supply</b>	6 AA batteries, AC adapters: US 110V, UK 240V, Europe 220V, or Lithium Ion Rechargeable Battery	AC Power, rechargeable NiMH battery	AA Alkaline batteries (8), AC Power, or rechargeable lithium ion battery
<b>Weight</b>	1.66 lbs (0.75 kg)	2.6 lbs (1.2 kg)	2.6 lbs (1.2 kg)
<b>Warranty</b>	2 years	2 years	2 years

\* Test 3rd party software integration for intended application prior to purchase. Windows® is a registered trademark of Microsoft Corporation.





**BMP<sup>®</sup>51 Label Printer**  
See page 300



**TLS 2200<sup>®</sup> / TLS PC Link<sup>™</sup> Thermal Label Printers**  
See page 310



**BMP<sup>®</sup>71 Label Printer**  
See page 324

Printer Specifications	BMP <sup>®</sup> 51 Label Printer	TLS 2200 <sup>®</sup> / TLS PC Link <sup>™</sup> Printers	BMP <sup>®</sup> 71 Label Printer
<b>Max Labels Per Day</b>	Average 500 labels/day	Average 750 labels/day	Average 1000 labels/day
<b>Print Resolution</b>	300 dpi	203 dpi	300 dpi
<b>Print Technology</b>	Thermal Transfer	Thermal Transfer	Thermal Transfer
<b>Print Speed</b>	25.4mm/sec (1/sec)	12 mm/sec (0.47 in/sec)	38mm/sec (1.5"/sec)
<b>Tape Widths (inches)</b>	Various sizes from 0.235" to 1.50"	Various sizes from 0.25" to 2.00"	Various sizes from 0.235" to 2.00"
<b>Tape Widths (mm)</b>	Various sizes from 6.4 mm to 38.1 mm	Various sizes from 6.4 to 50.8 mm	Various sizes from 6.4 to 50.8 mm
<b>Max Label Width</b>	1.50" (38.1mm)	2.00" (50.8mm)	2.00" (50.8mm)
<b>Max Print Width</b>	1.44" (36.6 mm)	1.810" (46.0mm)	1.92" (48.76 mm)
<b>Memory</b>	48 MB / Up to 25,000 Labels	21,000 characters / None	200 MB
<b>Materials Supported</b>	M-, MC-, MC1- Series Cartridges (all sizes) 140+ Stock Parts	PTL-, BPTL- Series 500+ Stock Parts	M71-, BM71-, BPTL- Series 450+ stock parts, plus TLS parts with adaptor
<b>Continuous vs Die Cut Labels</b>	Continuous and die cut labels	Continuous and die cut labels	Continuous and die cut labels
<b>Connectivity Options</b>	Yes	Serial	Yes
<b>PC Connectivity</b>	USB, WiFi, LAN	Yes	USB
<b>Software Compatibility</b>	LabelMark <sup>®</sup> / CodeSoft <sup>™</sup> Software	LabelMark <sup>®</sup> / CodeSoft <sup>™</sup> Software	LabelMark <sup>®</sup> / CodeSoft <sup>™</sup> Software
<b>Data Transfer from PC to printer</b>	Yes, with Labelmark <sup>®</sup> Software	No	Yes - with Labelmark <sup>®</sup> Software
<b>Wireless Connectivity</b>	Yes	No	No
<b>Stand Alone Printing</b>	Yes	Yes	Yes
<b>Color Capability</b>	Single print color on a label	Single Color Printing	Single print color on a label
<b>Keyboard</b>	QWERTY	ABC / None	QWERTY, AZERTY, QWERTZ, CYRILLIC
<b>Backlit Screen</b>	2.7" x 1.7", backlit	No	3.5", backlit
<b>Text Sizes</b>	4 to 103pt + autosizing	1 to 19 (4 to 72 point)	4 to 174 pt + autosizing
<b>Multi-Line Print</b>	Yes	Yes	Yes
<b>Print Rotation</b>	Yes	Yes	Yes
<b>Serialization</b>	Yes	Yes	Yes, multiple and linked
<b>Barcode</b>	39 and 128	128, IFT 25, Codabar	39 and 128
<b>Symbols</b>	450	44 on keypad / LabelMark Supported Symbols	500+
<b>Portability</b>	Yes	Yes / No	Yes
<b>Label Types or Application Functions</b>	Polyester (Metallized, Ultra Aggressive, & High Performance) Polyethylene Tag, Permasleeve <sup>®</sup> Heat Shrinking Tube, Tamper-Evident Vinyl, Polypropylene Tag, Permanent Polypropylene, Self-Laminating vinyl, Self-Laminating Polyester, Staingerbondz <sup>™</sup> Labels, Tissue Cassette Polyester, Freezerbondz <sup>™</sup> Labels, Repositionable Vinyl Cloth, Reflective, Indoor/Outdoor Vinyl	Banner Portrait, Banner Landscape, Wire, Patch Panel, Terminal Block, Desi Strip, Fixed Length	Polyester (Adhesive, Permanent, Metallized, Clear, Flame Retardant, Ultra Aggressive, & High Performance, Engraved Plate Substitute) Polyethylene Tag, Polyethylene, Block Vinyl, Permasleeve <sup>®</sup> Heat Shrinking, Polypropylene Tag, Polyimide, Vinyl (Tamper-Evident, Destructible, Repositional, Self Laminating, Indoor/Outdoor) Polyimide, Repositionable Vinyl Cloth, Nylon Cloth, Polypropylene Tape, Phosphorescent, Reflective, Tedlar, ToughWash, ToughWash Metal Detectable
<b>Applications</b>	Data Communications Labeling, Facility, Safety & Maintenance Identification, General & Industrial Labeling, Laboratory Identification, Panel Identification, Security Identification, Wire & Cable Marking	Circuit Board Labeling, Data Communications Labeling, Facility, Safety & Maintenance Identification, General & Industrial Labeling, Laboratory Identification, Panel Identification, Security Identification, Wire & Cable Marking	Circuit Board Labeling, Data Communications Labeling, Facility, Safety & Maintenance Identification, General & Industrial Labeling, Panel Identification, Security Identification, Wire & Cable Marking, Pipe Marking
<b>Power Supply</b>	AA Alkaline batteries (8), AC Power, or rechargeable lithium ion battery	Rechargeable Battery, AC Power (optional)	Rechargeable NiMH battery, AC Power/battery changer
<b>Weight</b>	2.6 lbs (1.2 kg)	2.75 lbs (1.25kg) / 2.5 lbs (1.13kg)	5.429 lbs (2.47 kg)
<b>Warranty</b>	2 years	1 year	1 year

\* Test 3rd party software integration for intended application prior to purchase. Windows<sup>®</sup> is a registered trademark of Microsoft Corporation.



# BMP®21-PLUS Label Printer

BradyID.com/bmp21plus

Portable Printers



## BMP®21-PLUS LABEL PRINTER

**TOUGH on the Outside. SMART on the Inside.**

- Automatic-label formatting for wire wraps, patch panels, terminal-blocks, cable flags, circuit breaker arrays and general banner labels
- Drop-lock-and-print materials
- Passed shock and vibration testing per MIL-STD-810G Method 5.16.6 S4.6.5
- Rechargeable Li-ION battery
- Continuous-only supplies in 0.25" to 0.75" widths
- 70 total label parts, 7 materials
- Label grabber holds label after cutting
- 104 symbols for electric, smart home, safety and datacom
- 2-year warranty

**▶ Online Video!**  
Visit [BradyID.com/bmp21plus](http://BradyID.com/bmp21plus) to watch the printer video or request a printer demo.

**Your Complete Printing Solution:**  
BMP®21-PLUS cartridges with label and print ribbon ..... page 291



BMP21-PLUS Printer Kit shown.

### BMP®21-PLUS Printer Specifications

<b>Max Labels Per Day</b>	Average 100 labels/day
<b>Print Resolution</b>	203 dpi
<b>Print Technology</b>	Thermal transfer
<b>Print Speed</b>	10mm/sec (0.4 in/sec)
<b>Tape Widths (inches)</b>	Various sizes from 0.250" to 0.750"
<b>Tape Widths (mm)</b>	Various sizes from 6.4 mm to 19.1 mm
<b>Max Label Width</b>	0.75" (19.1 mm)
<b>Max Print Width</b>	0.63" (16 mm)
<b>Memory</b>	16MB, 10 Labels (2MB available for storage)
<b>Materials Supported</b>	M21- Series Cartridges 70+ Stock Parts
<b>Continuous vs Die Cut Labels</b>	Continuous Only
<b>Connectivity Options</b>	Not Applicable
<b>PC Connectivity</b>	No
<b>Software Compatibility</b>	No
<b>File Transfer from PC to printer</b>	No
<b>Wireless Connectivity</b>	No
<b>Stand Alone Printing</b>	Yes
<b>Color Capability</b>	Single print color on a label
<b>Keyboard</b>	ABC or Cyrillic
<b>Backlit Screen</b>	2" x 1", user adjustable backlit
<b>Text Sizes</b>	6-40 pt with Autosizing
<b>Multi-Line Print</b>	Yes
<b>Print Rotation</b>	No
<b>Serialization</b>	Yes
<b>Barcode</b>	39 and 128
<b>Symbols Categories</b>	104
<b>Portability</b>	Yes
<b>Label Types or Application Functions</b>	PermaSleeve® Heat Shrink Tubing, Permanent Polyester, Self-laminating Vinyl, Clear Polyester, High Performance Polyester, Nylon Cloth, Indoor/Outdoor Vinyl, Polypropylene
<b>Applications</b>	Basic labels for Wire and Cable ID, Datacomm and AV labeling, Inside-panel Component Labeling, and General Industrial Labels for Maintenance, Production and Visual Workplace/Lean 5S.
<b>Power Supply</b>	6 AA batteries, AC adapters: US 110V, UK 240V, Europe 220V, or Lithium Ion Rechargeable Battery
<b>Weight</b>	1.66 lbs (0.75 kg)
<b>Warranty</b>	2 years

### BMP®21-PLUS Label Printer & Accessories

Catalog #	Description
BMP21-PLUS	BMP21 Label Printer*
BMP21-PLUS-KIT1	BMP21 Label Printer Kit**
BMP21-MAGNET	Magnet Only Accessory
BMP21-TOOL	Multi-functional Tool Accessory (magnet / flashlight / retractable stand)
M-AC-110937	AC Power Adapter / Charger
BMP21-PLUS-BATT	Li-ION Battery Pack
BMP21-PLUS-HC	Hard Case

\* Printer includes label cartridge, lanyard and quick start guide (batteries not included).

\*\* Printer kit includes: printer, label cartridge, Li-ION battery, AC power / charger, hard case, lanyard and quick start guide.

US Patent No. 8.322.936.

## An affordable label and wire marker printer designed for the tool box



Electrical Labeling



Voice & Data Communications



Self-Laminating Wire Labels



PermaSleeve® Wire Marking Sleeves



General ID



Lean / 5S Labels and Operations ID

## Indoor/Outdoor Vinyl (B-595)

- Ideal for labeling components inside panels as well as for Lean / 5S labels, equipment markings, and production area ID
- 8-10 years average outdoor vinyl label durability
- Very pliable with aggressive adhesive to conform to irregular, rough and curved surfaces
- Stands up to grease, oil, dirt, grime and most industrial chemicals

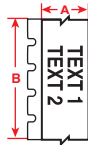

Figure 33



Diagram	Part Number	B#	Material	Color	Label Width A Inch (mm)	Roll Length B Inch (mm)	Labels/Roll
Fig. 33*	M21-250-595-WT	B-595	Vinyl	Black on White	0.250 (6.35)	21 ft (6.40 m)	1 roll (cont.)
Fig. 33	M21-375-595-WT	B-595	Vinyl	Black on White	0.375 (9.53)	21 ft (6.40 m)	1 roll (cont.)
Fig. 33	M21-500-595-WT	B-595	Vinyl	Black on White	0.500 (12.70)	21 ft (6.40 m)	1 roll (cont.)
Fig. 33	M21-750-595-WT	B-595	Vinyl	Black on White	0.750 (19.05)	21 ft (6.40 m)	1 roll (cont.)
Fig. 33*	M21-250-595-YL	B-595	Vinyl	Black on Yellow	0.250 (6.35)	21 ft (6.40 m)	1 roll (cont.)
Fig. 33	M21-375-595-YL	B-595	Vinyl	Black on Yellow	0.375 (9.53)	21 ft (6.40 m)	1 roll (cont.)
Fig. 33	M21-500-595-YL	B-595	Vinyl	Black on Yellow	0.500 (12.70)	21 ft (6.40 m)	1 roll (cont.)
Fig. 33	M21-750-595-YL	B-595	Vinyl	Black on Yellow	0.750 (19.05)	21 ft (6.40 m)	1 roll (cont.)
Fig. 33	M21-375-595-OR	B-595	Vinyl	Black on Orange	0.375 (9.53)	21 ft (6.40 m)	1 roll (cont.)
Fig. 33	M21-500-595-OR	B-595	Vinyl	Black on Orange	0.500 (12.70)	21 ft (6.40 m)	1 roll (cont.)
Fig. 33	M21-750-595-OR	B-595	Vinyl	Black on Orange	0.750 (19.05)	21 ft (6.40 m)	1 roll (cont.)
Fig. 33	M21-375-595-BK	B-595	Vinyl	White on Black	0.375 (9.53)	21 ft (6.40 m)	1 roll (cont.)
Fig. 33	M21-500-595-BK	B-595	Vinyl	White on Black	0.500 (12.70)	21 ft (6.40 m)	1 roll (cont.)
Fig. 33	M21-750-595-BK	B-595	Vinyl	White on Black	0.750 (19.05)	21 ft (6.40 m)	1 roll (cont.)
Fig. 33	M21-375-595-RD	B-595	Vinyl	White on Red	0.375 (9.53)	21 ft (6.40 m)	1 roll (cont.)
Fig. 33	M21-500-595-RD	B-595	Vinyl	White on Red	0.500 (12.70)	21 ft (6.40 m)	1 roll (cont.)
Fig. 33	M21-750-595-RD	B-595	Vinyl	White on Red	0.750 (19.05)	21 ft (6.40 m)	1 roll (cont.)
Fig. 33	M21-375-595-BL	B-595	Vinyl	White on Blue	0.375 (9.53)	21 ft (6.40 m)	1 roll (cont.)
Fig. 33	M21-500-595-BL	B-595	Vinyl	White on Blue	0.500 (12.70)	21 ft (6.40 m)	1 roll (cont.)
Fig. 33	M21-750-595-BL	B-595	Vinyl	White on Blue	0.750 (19.05)	21 ft (6.40 m)	1 roll (cont.)
Fig. 33	M21-375-595-BR	B-595	Vinyl	White on Brown	0.375 (9.53)	21 ft (6.40 m)	1 roll (cont.)
Fig. 33	M21-500-595-BR	B-595	Vinyl	White on Brown	0.500 (12.70)	21 ft (6.40 m)	1 roll (cont.)
Fig. 33	M21-750-595-BR	B-595	Vinyl	White on Brown	0.750 (19.05)	21 ft (6.40 m)	1 roll (cont.)
Fig. 33	M21-375-595-GN	B-595	Vinyl	White on Green	0.375 (9.53)	21 ft (6.40 m)	1 roll (cont.)
Fig. 33	M21-500-595-GN	B-595	Vinyl	White on Green	0.500 (12.70)	21 ft (6.40 m)	1 roll (cont.)
Fig. 33	M21-750-595-GN	B-595	Vinyl	White on Green	0.750 (19.05)	21 ft (6.40 m)	1 roll (cont.)
Fig. 33	M21-375-595-PL	B-595	Vinyl	White on Purple	0.375 (9.53)	21 ft (6.40 m)	1 roll (cont.)
Fig. 33	M21-500-595-PL	B-595	Vinyl	White on Purple	0.500 (12.70)	21 ft (6.40 m)	1 roll (cont.)
Fig. 33	M21-750-595-PL	B-595	Vinyl	White on Purple	0.750 (19.05)	21 ft (6.40 m)	1 roll (cont.)
Fig. 33	M21-375-595-GY	B-595	Vinyl	Black on Grey	0.375 (9.53)	21 ft (6.40 m)	1 roll (cont.)
Fig. 33	M21-500-595-GY	B-595	Vinyl	Black on Grey	0.500 (12.70)	21 ft (6.40 m)	1 roll (cont.)
Fig. 33	M21-750-595-GY	B-595	Vinyl	Black on Grey	0.750 (19.05)	21 ft (6.40 m)	1 roll (cont.)

\* Cartridge is only compatible with the BMP®21-PLUS printer.



### M21 Cartridges - Did You Know?



1. The necessary print ribbons for the BMP®21 Label Printer are self-contained within the label roll cartridge. So there's no need to order or load separate print ribbons!



2. M21 cartridges are compatible with the BMP®21-PLUS, BMP®21-LAB, BMP®21, IDPaI™ and LabPaI™ printer models unless otherwise noted.



# BMP®21-PLUS Materials

BradyID.com/bmp21plus

## Nylon Cloth Wire & Cable Wraps (B-499)

- Nylon cloth wrap-around label is highly pliable conforming to tightly curved surfaces
- Text auto-repeats when in wire marker mode
- Can be used for flagging with flag mode in printer

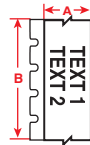

Figure 33



Diagram	Catalog #	B#	Material	Color	Label Width A Inch (mm)	Roll Length B Inch (mm)	Labels/Roll
Fig. 33	M21-375-499	B-499	Nylon Cloth	Black on White	0.375 (9.53)	16 ft (4.88 m)	1 roll (cont.)
Fig. 33	M21-500-499	B-499	Nylon Cloth	Black on White	0.500 (12.70)	16 ft (4.88 m)	1 roll (cont.)
Fig. 33	M21-750-499	B-499	Nylon Cloth	Black on White	0.750 (19.05)	16 ft (4.88 m)	1 roll (cont.)

## Self-Laminating Vinyl Wire & Cable Labels\* (B-427)

- Clear, wrap-around tail overlaminates white print-on area to protect text
- Great for data cables or wires that are frequently handled & moved

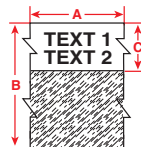

Figure 42

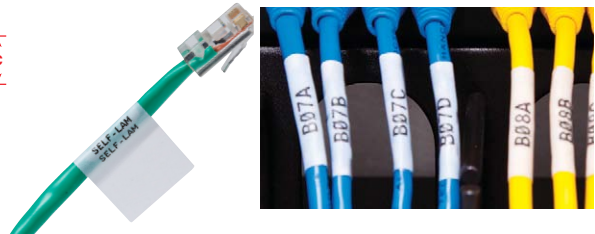

Diagram	Catalog #	B#	Material	Color	Approx. Wire Gauge	Label Width A Inch (mm)	Roll Length B Inch (mm)	Print-On Height C Inch (mm)	Labels/Roll
Fig. 42a*	M21-750-427	B-427	Vinyl	Black on White	16-10	0.75 (19.05)	14 ft (4.27 m)	0.375 (9.53)	1 roll (cont.)
Fig. 42a*	M21-1000-427	B-427	Vinyl	Black on White	12-10	1.00 (25.40)	14 ft (4.27 m)	0.375 (9.53)	1 roll (cont.)
Fig. 42a*	M21-1250-427	B-427	Vinyl	Black on White	10-4	1.25 (30.48)	14 ft (4.27 m)	0.50 (12.70)	1 roll (cont.)
Fig. 42a*	M21-1500-427	B-427	Vinyl	Black on White	10-4	1.50 (38.10)	14 ft (4.27 m)	0.50 (12.70)	1 roll (cont.)

\* Cartridge is only compatible with the BMP®21-PLUS and BMP®21 printers.

## PermaSleeve® PS Heat Shrink Marking Sleeves (B-342)

- 3:1 heat shrink ratio, wire marker sleeve
- Polyolefin fade-resistant, flame-retardant, and superior aesthetic appearance
- Meets SAE, MIL-STD specs\*

\* Visit BradyID.com/techdata for more information

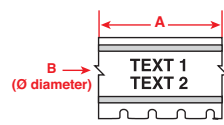

Figure 58



Diagram	Catalog #	B#	Material	Color	Approx. Wire Gauge*	Max Wire Dia. Inch (mm)	Supplied Dia. B Inch (mm)	Sleeve Length A Inch (mm)	Labels/Roll
Fig. 58*	M21-125-C-342	B-342	Polyolefin	Black on White	22-16 Gauge	0.046 - 0.110 (1.2 - 2.8)	0.125 (3.2)	7 ft (2.13 m)	1 roll (cont.)
Fig. 58	M21-187-C-342	B-342	Polyolefin	Black on White	20-10 Gauge	0.062 - 0.150 (1.6 - 3.8)	0.187 (4.9)	7 ft (2.13 m)	1 roll (cont.)
Fig. 58	M21-250-C-342	B-342	Polyolefin	Black on White	16-8 Gauge	0.094 - 0.215 (2.4 - 5.5)	0.250 (6.9)	7 ft (2.13 m)	1 roll (cont.)
Fig. 58	M21-375-C-342	B-342	Polyolefin	Black on White	12-4 Gauge	0.125 - 0.320 (3.2 - 8.1)	0.375 (10.7)	7 ft (2.13 m)	1 roll (cont.)
Fig. 58*	M21-125-C-342-YL	B-342	Polyolefin	Black on Yellow	22-16 Gauge	0.046 - 0.110 (1.2 - 2.8)	0.125 (3.2)	7 ft (2.13 m)	1 roll (cont.)
Fig. 58	M21-187-C-342-YL	B-342	Polyolefin	Black on Yellow	20-10 Gauge	0.062 - 0.150 (1.6 - 3.8)	0.187 (4.9)	7 ft (2.13 m)	1 roll (cont.)
Fig. 58	M21-250-C-342-YL	B-342	Polyolefin	Black on Yellow	16-8 Gauge	0.094 - 0.215 (2.4 - 5.5)	0.250 (6.9)	7 ft (2.13 m)	1 roll (cont.)
Fig. 33	M21-375-C-342-YL	B-342	Polyolefin	Black on Yellow	12-4 Gauge	0.125 - 0.320 (3.2 - 8.1)	0.375 (10.7)	7 ft (2.13 m)	1 roll (cont.)

\* Cartridge is only compatible with the BMP®21-PLUS printer.

## Terminal Block Adhesive Strips (B-499)

- Narrow nylon cloth label strips for alignment on terminal blocks
- Prints with user-specified spacing when using terminal block mode



Figure 33



Diagram	Catalog #	B#	Material	Color	Label Width A Inch (mm)	Roll Length B Inch (mm)	Labels/Roll
Fig. 33	M21-375-499-TB	B-499	Nylon Cloth	Black on White	0.375 (9.53)	16 ft (4.88 m)	1 roll (cont.)
Fig. 33	M21-500-499-TB	B-499	Nylon Cloth	Black on White	0.500 (12.70)	16 ft (4.88 m)	1 roll (cont.)

## Patch Panel Adhesive Strips (B-499, B-595)

- Port identification with user-specified spacing when using patch panel mode



Figure 33



Diagram	Catalog #	B#	Material	Color	Label Width A Inch (mm)	Roll Length B Inch (mm)	Labels/Roll
<b>B-499 Nylon Cloth</b>							
Fig. 33	M21-375-499	B-499	Nylon Cloth	Black on White	0.375 (9.53)	16 ft (4.88 m)	1 roll (cont.)
Fig. 33	M21-500-499	B-499	Nylon Cloth	Black on White	0.500 (12.70)	16 ft (4.88 m)	1 roll (cont.)
<b>B-595 Vinyl</b>							
Fig. 33	M21-375-595-WT	B-595	Vinyl	Black on White	0.375 (9.53)	21 ft (6.40 m)	1 roll (cont.)
Fig. 33	M21-500-595-WT	B-595	Vinyl	Black on White	0.500 (12.70)	21 ft (6.40 m)	1 roll (cont.)

## Polyester Labels for Inside Panel Markings and General ID (B-423, B-430, B-488)

- High performance white or clear polyester material
- Best for flat, smooth surfaces
- B-488 is a solvent-resistant material

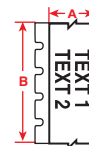

Figure 33



Diagram	Catalog #	B#	Material	Color	Label Width A Inch (mm)	Roll Length B Inch (mm)	Labels/Roll
<b>B-423 Polyester (gloss white)</b>							
Fig. 33*	M21-250-423	B-423	Polyester	Black on White	0.250 (6.35)	21 ft (6.40 m)	1 roll (cont.)
Fig. 33	M21-375-423	B-423	Polyester	Black on White	0.375 (9.53)	21 ft (6.40 m)	1 roll (cont.)
Fig. 33	M21-500-423	B-423	Polyester	Black on White	0.500 (12.70)	21 ft (6.40 m)	1 roll (cont.)
Fig. 33	M21-750-423	B-423	Polyester	Black on White	0.750 (19.05)	21 ft (6.40 m)	1 roll (cont.)
<b>B-430 Polyester (clear)</b>							
Fig. 33*	M21-250-430	B-430	Polyester	Black on Clear	0.250 (6.35)	21 ft (6.40 m)	1 roll (cont.)
Fig. 33	M21-375-430	B-430	Polyester	Black on Clear	0.375 (9.53)	21 ft (6.40 m)	1 roll (cont.)
Fig. 33	M21-500-430	B-430	Polyester	Black on Clear	0.500 (12.70)	21 ft (6.40 m)	1 roll (cont.)
Fig. 33	M21-750-430	B-430	Polyester	Black on Clear	0.750 (19.05)	21 ft (6.40 m)	1 roll (cont.)
Fig. 33*	M21-250-430-WT-CL	B-430	Polyester	White on Clear	0.250 (6.35)	21 ft (6.40 m)	1 roll (cont.)
Fig. 33	M21-375-430-WT-CL	B-430	Polyester	White on Clear	0.375 (9.53)	21 ft (6.40 m)	1 roll (cont.)
Fig. 33	M21-500-430-WT-CL	B-430	Polyester	White on Clear	0.500 (12.70)	21 ft (6.40 m)	1 roll (cont.)
Fig. 33	M21-750-430-WT-CL	B-430	Polyester	White on Clear	0.750 (19.05)	21 ft (6.40 m)	1 roll (cont.)
<b>B-488 Polyester (matte white)</b>							
Fig. 33	M21-375-488	B-488	Polyester	Black on White	0.375 (9.53)	21 ft (6.40 m)	1 roll (cont.)
Fig. 33	M21-500-488	B-488	Polyester	Black on White	0.500 (12.70)	21 ft (6.40 m)	1 roll (cont.)
Fig. 33	M21-750-488	B-488	Polyester	Black on White	0.750 (19.05)	21 ft (6.40 m)	1 roll (cont.)

B-499 (Nylon Cloth) or B-595 (Indoor/Outdoor Vinyl) label materials are recommended if surface is highly textured.

\* Cartridge is only compatible with the BMP®21-PLUS printer.



# BMP®41 Label Printer

BradyID.com/bmp41

Portable Printers



## BMP®41 LABEL PRINTER

### ONE AND DONE. BMP®41 Printer Does It All!

A rugged, handheld labeling solution that gives you the versatility of die-cut labels and continuous labels in one printer!

- Quick-load, drop-in cartridges for quick supply change and automatic label formatting
- Fast print speed of 1.3" per second
- Over 100 label parts in 11 materials
- 3/4" sleeves and 1" wide continuous output
- Drop tested rugged industrial bumpers with a grab and go grip to be on the move with you
- Large graphical LCD display with backlight to see exactly what you're printing
- Rechargeable NiMH battery, AA or AC adapter, for long lasting power supply
- Built-in wizard-style apps for wire ID, cable flags, terminal blocks, patch panels, breaker boxes and general ID

#### BMP®41 Printer Specifications

<b>Max Labels Per Day</b>	Average 250 labels/day
<b>Print Resolution</b>	300 dpi
<b>Print Technology</b>	Thermal transfer
<b>Print Speed</b>	133mm/sec (1.3in/sec)
<b>Tape Widths (inches)</b>	Various sizes from 0.235" to 1.0"
<b>Tape Widths (mm)</b>	Various sizes from 5.969 mm to 25.4 mm
<b>Max Label Width</b>	1.00" (25.4mm)
<b>Max Print Width</b>	0.96" (24.4 mm)
<b>Memory</b>	48 MB / Up to 25,000 Labels
<b>Materials Supported</b>	M-, MC-, MC1- Series Cartridges (1.00" and 0.75" height only) 100+ Stock Parts
<b>Continuous vs Die Cut Labels</b>	Continuous and die cut labels
<b>Connectivity Options</b>	Yes
<b>PC Connectivity</b>	USB
<b>Software Compatibility</b>	Optional through USB
<b>File Transfer from PC to printer</b>	Yes - with Labelmark® Software
<b>Wireless Connectivity</b>	No
<b>Stand Alone Printing</b>	Yes
<b>Color Capability</b>	Single print color on a label
<b>Keyboard</b>	QWERTY
<b>Backlit Screen</b>	2.5" x 1.4", user adjustable backlight
<b>Text Sizes</b>	4 to 103pt + autosizing
<b>Multi-Line Print</b>	Yes
<b>Print Rotation</b>	Yes
<b>Serialization</b>	Yes
<b>Barcode</b>	39 and 128
<b>Symbols Categories</b>	450
<b>Portability</b>	Yes
<b>Label Types or Application Functions</b>	Adhesive Polyester, PermaSleeve® Heat Shrink Tubing, Polypropylene Tags, Self-laminating Vinyl, Metallized Polyester Ultra Aggressive Polyester, Repositional Vinnl Cloth, Nylon Cloth, Reflective Tape, Indoor/Outdoor Vinyl,
<b>Applications</b>	Basic and Die Cut labels for Wire and Cable ID, Datacomm and AV labeling, Electrical ID, Panel ID, Product ID, Facility ID, Safety and Maintenance, General ID
<b>Power Supply</b>	AC Power, rechargeable NiMH battery
<b>Weight</b>	2.6 lbs (1.2 kg)
<b>Warranty</b>	2 years



#### Online Video!

Visit [BradyID.com/bmp41](http://BradyID.com/bmp41) for more information or to view an online printer demo video.

#### Your Complete Printing Solution:

BMP41 cartridges with label and print ribbon .....page 298

#### BMP®41 Label Printer & Accessories

Catalog #	Description
BMP41	BMP41 Label Printer with Hard Case*
BMP41-KIT-VD	BMP41 Printer DataComm Starter Kit*
BMP41-KIT-EL	BMP41 Printer Electrical Starter Kit*
BMP41-KIT-GI	BMP41 Printer Facility ID Starter Kit*
BMP41-BATT	BMP41 Rechargeable Battery Pack
BMP41-QC	BMP41 External Battery Quick Charger
BMP41-AC	BMP41 AC Adapter / Battery Charger
BMP41-MAGNET	BMP41 Magnet Accessory
BMP41-HC	BMP41 Hard Case
BMP41-USB	BMP41 USB Cable

\*Printer ships with BMP41 printer, NiMH battery, AC adapter / charger, hard case, MC1-1000-595-WT-BK cartridge, USB cable, product & drivers CD, and quick start guide.

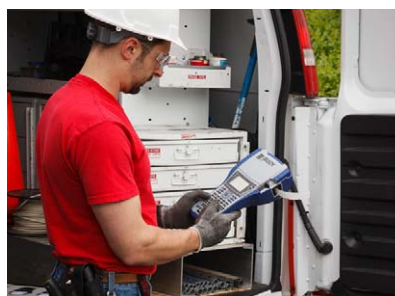

### Exceptional material variety and durability.



Electrical Labeling



Equipment Labeling



Self-Laminating Labels



Voice & Data Communications



PermaSleeve® Wire Marking

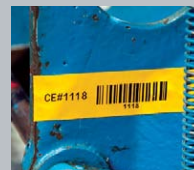

Indoor / Outdoor Vinyl Labels...and more!

## Save with a BMP®41 Label Printer Starter Kit



### BMP®41 Starter Kits

Catalog #	Description
BMP41-KIT-VD	BMP41 DataComm Starter Kit
BMP41-KIT-EL	BMP41 Electrical Starter Kit
BMP41-KIT-GI	BMP41 Facility ID Starter Kit

\*Printer ships with BMP41 Rechargeable Battery Pack, MC1-1000-595-WT-BK cartridge, USB Cable, AC Adapter, Product CD, Brady Printer Drivers CD and Quick Start Guide.

### BMP®41 DataComm Starter Kit Includes:

- 1 - BMP41 Label Maker Standard Package (BMP41-KIT)
- 1 - BMP41 Hard Case (BMP41-HC)
- 1 - B-427 1.0" White Label Roll (M-51-427)
- 1 - B-412 0.475" White Label Roll (MC-475-412)
- 1 - B-5951.0" Black on Yellow Label Roll (MC1-1000-595-YL-BK)
- 1 - B-5951.0" Black on White Label Roll (MC1-1000-595-WT-BK)

### BMP®41 Electrical Starter Kit Includes:

- 1 - BMP41 Label Maker Standard Package (BMP41-KIT)
- 1 - BMP41 Hard Case (BMP41-HC)
- 1 - B-427 1.0" White Label Roll (M-143-427)
- 1 - B-498 1.0" White Label Roll (M-48-498)
- 1 - B-342 0.75" White Label Roll (M-187-075-342)
- 1 - B-595 1.0" Black on Orange Label Roll (MC1-1000-595-OR-BK)
- 1 - B-595 1.0" Black on White Label Roll (MC1-1000-595-WT-BK)

### BMP®41 Facility ID Starter Kit Includes:

- 1 - BMP41 Label Maker Standard Package (BMP41-KIT)
- 1 - B-595 1.0" Black on Yellow Label Roll (MC1-1000-595-YL-BK)
- 1 - B-595 1.0" Red on White Label Roll (MC1-1000-595-WT-RD)
- 1 - B-595 1.0" White on Green Label Roll (MC1-1000-595-GN-WT)
- 1 - B-595 1.0" Black on White Label Roll (MC1-1000-595-WT-BK)
- 1 - B-483 1.0" White Label Roll (M-60-483)

## Indoor / Outdoor Grade Facility & Safety Labels

This low-shrink, continuous vinyl material is pliable with an extremely aggressive adhesive that conforms to smooth or rough surfaces. Ideal for lean 5S labels, pipe markers, equipment and panel labels, and production area ID. Lasting up to 8-10 years outdoors, these labels offer excellent resistance to oils, detergents, dirt, grime and many solvents.

**B-595 Indoor/Outdoor Vinyl Material** - Permanent adhesive, very pliable, good for rough surfaces and outdoor use, wide range of colors. Temp. Range: -40°F to 248°F (-40°C to 120°C). UL recognized.



Figure 33



Fits Printer Models	Diagram	Catalog #	B#	Material	Color	Label Width A Inch (mm)	Roll Length B Inch (mm)	Labels/Roll
<b>B-595 – Indoor/Outdoor Vinyl Tape</b>								
BMP41, 51, 53	Fig. 33	MC-500-595-WT-BK	B-595	Vinyl	BK on WT	0.500 (12.7)	25 ft. (7.6 m)	1 roll (cont.)
BMP41, 51, 53	Fig. 33	MC-750-595-WT-BK	B-595	Vinyl	BK on WT	0.750 (19.1)	25 ft. (7.6 m)	1 roll (cont.)
BMP41, 51, 53	Fig. 33	MC1-1000-595-WT-BK	B-595	Vinyl	BK on WT	1.000 (25.4)	25 ft. (7.6 m)	1 roll (cont.)
BMP41, 51, 53	Fig. 33	MC-500-595-YL-BK	B-595	Vinyl	BK on YL	0.500 (12.7)	25 ft. (7.6 m)	1 roll (cont.)
BMP41, 51, 53	Fig. 33	MC-750-595-YL-BK	B-595	Vinyl	BK on YL	0.750 (19.1)	25 ft. (7.6 m)	1 roll (cont.)
BMP41, 51, 53	Fig. 33	MC1-1000-595-YL-BK	B-595	Vinyl	BK on YL	1.000 (25.4)	25 ft. (7.6 m)	1 roll (cont.)
BMP41, 51, 53	Fig. 33	MC-500-595-OR-BK	B-595	Vinyl	BK on OR	0.500 (12.7)	25 ft. (7.6 m)	1 roll (cont.)
BMP41, 51, 53	Fig. 33	MC-750-595-OR-BK	B-595	Vinyl	BK on OR	0.750 (19.1)	25 ft. (7.6 m)	1 roll (cont.)
BMP41, 51, 53	Fig. 33	MC1-1000-595-OR-BK	B-595	Vinyl	BK on OR	1.000 (25.4)	25 ft. (7.6 m)	1 roll (cont.)
BMP41, 51, 53	Fig. 33	MC-500-595-BL-WT	B-595	Vinyl	WT on BL	0.500 (12.7)	25 ft. (7.6 m)	1 roll (cont.)
BMP41, 51, 53	Fig. 33	MC-750-595-BL-WT	B-595	Vinyl	WT on BL	0.750 (19.1)	25 ft. (7.6 m)	1 roll (cont.)
BMP41, 51, 53	Fig. 33	MC1-1000-595-BL-WT	B-595	Vinyl	WT on BL	1.000 (25.4)	25 ft. (7.6 m)	1 roll (cont.)
BMP41, 51, 53	Fig. 33	MC-500-595-RD-WT	B-595	Vinyl	WT on RD	0.500 (12.7)	25 ft. (7.6 m)	1 roll (cont.)
BMP41, 51, 53	Fig. 33	MC-750-595-RD-WT	B-595	Vinyl	WT on RD	0.750 (19.1)	25 ft. (7.6 m)	1 roll (cont.)
BMP41, 51, 53	Fig. 33	MC1-1000-595-RD-WT	B-595	Vinyl	WT on RD	1.000 (25.4)	25 ft. (7.6 m)	1 roll (cont.)
BMP41, 51, 53	Fig. 33	MC-500-595-GN-WT	B-595	Vinyl	WT on GN	0.500 (12.7)	25 ft. (7.6 m)	1 roll (cont.)
BMP41, 51, 53	Fig. 33	MC-750-595-GN-WT	B-595	Vinyl	WT on GN	0.750 (19.1)	25 ft. (7.6 m)	1 roll (cont.)
BMP41, 51, 53	Fig. 33	MC1-1000-595-GN-WT	B-595	Vinyl	WT on GN	1.000 (25.4)	25 ft. (7.6 m)	1 roll (cont.)
BMP41, 51, 53	Fig. 33	MC-500-595-WT-RD	B-595	Vinyl	RD on WT	0.500 (12.7)	25 ft. (7.6 m)	1 roll (cont.)
BMP41, 51, 53	Fig. 33	MC-750-595-WT-RD	B-595	Vinyl	RD on WT	0.750 (19.1)	25 ft. (7.6 m)	1 roll (cont.)
BMP41, 51, 53	Fig. 33	MC1-1000-595-WT-RD	B-595	Vinyl	RD on WT	1.000 (25.4)	25 ft. (7.6 m)	1 roll (cont.)
BMP41, 51, 53	Fig. 33	MC-500-595-BK-WT	B-595	Vinyl	WT on BK	0.500 (12.7)	25 ft. (7.6 m)	1 roll (cont.)
BMP41, 51, 53	Fig. 33	MC-750-595-BK-WT	B-595	Vinyl	WT on BK	0.750 (19.1)	25 ft. (7.6 m)	1 roll (cont.)
BMP41, 51, 53	Fig. 33	MC1-1000-595-BK-WT	B-595	Vinyl	WT on BK	1.000 (25.4)	25 ft. (7.6 m)	1 roll (cont.)
BMP41, 51, 53	Fig. 33	MC-500-595-CL-BK	B-595	Vinyl	BK on CL	0.500 (12.7)	25 ft. (7.6 m)	1 roll (cont.)
BMP41, 51, 53	Fig. 33	MC-750-595-CL-BK	B-595	Vinyl	BK on CL	0.750 (19.1)	25 ft. (7.6 m)	1 roll (cont.)
BMP41, 51, 53	Fig. 33	MC1-1000-595-CL-BK	B-595	Vinyl	BK on CL	1.000 (25.4)	20 ft. (7.6 m)	1 roll (cont.)
BMP41, 51, 53	Fig. 33	MC-500-595-CL-WT	B-595	Vinyl	WT on CL	0.500 (12.7)	25 ft. (7.6 m)	1 roll (cont.)
BMP41, 51, 53	Fig. 33	MC-750-595-CL-WT	B-595	Vinyl	WT on CL	0.750 (19.1)	25 ft. (7.6 m)	1 roll (cont.)
BMP41, 51, 53	Fig. 33	MC1-1000-595-CL-WT	B-595	Vinyl	WT on CL	1.000 (25.4)	20 ft. (7.6 m)	1 roll (cont.)



BradyID.com/bmp41

## Bin, Storage, Reflective and General Industrial Labels (B-422, B-483, B-499, B-584, and B-595)

Several materials with an aggressive adhesive for use in commercial and industrial applications. Reflective materials can be used for low light or inclement weather conditions on outdoor utility poles and pedestals, job-site equipment and roof-top equipment.

**B-422 Polyester Material** - Permanent adhesive, good for powder-coated/textured surfaces. Best on flat surfaces. Temp. Range: -40°F to 212°F (-40°C to 100°C). UL recognized.

**B-483 Polyester Material** - Permanent adhesive for powder-coated/textured surfaces. Best on flat surfaces Temp. Range: -40°F to 248°F (-40°C to 120°C). UL recognized.

**B-499 Nylon Cloth Material** - Permanent adhesive. Pliable for rough or smooth surfaces. Temp. Range: -94°F to 194°F (-70°C to 90°C). UL recognized.

**B-584 Reflective Tape** - Reflective material shines back brightly when struck by light.

**B-595 Indoor/Outdoor Vinyl Material** - Permanent adhesive, very pliable, good for rough surfaces and outdoor use, wide range of colors. Temp. Range: -40°F to 248°F (-40°C to 120°C). UL recognized.

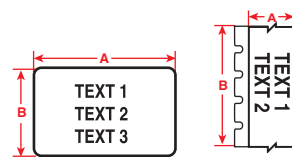

Figure 29

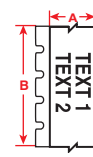

Figure 33

Fits Printer Models	Diagram	Catalog #	B#	Material	Color	Label Width A Inch (mm)	Label Height B Inch (mm)	Labels/Roll
<b>B-422 – Polyester Material</b>								
BMP41, 51, 53	Fig. 33	MC-375-422	B-422	Polyester	BK on WT	0.375 (9.5)	25 ft. (7.6 m)	1 roll (cont.)
BMP41, 51, 53	Fig. 33	MC-475-422	B-422	Polyester	BK on WT	0.475 (12.1)	25 ft. (7.6 m)	1 roll (cont.)
BMP41, 51, 53	Fig. 29	M-7-422	B-422	Polyester	BK on WT	0.500 (12.7)	0.500 (12.7)	280
BMP41, 51, 53	Fig. 33	MC-500-422	B-422	Polyester	BK on WT	0.500 (12.7)	25 ft. (7.6 m)	1 roll (cont.)
BMP41, 51, 53	Fig. 33	MC-625-422	B-422	Polyester	BK on WT	0.625 (15.9)	25 ft. (7.6 m)	1 roll (cont.)
BMP41, 51, 53	Fig. 29	M-47-422	B-422	Polyester	BK on WT	1.000 (25.4)	0.500 (12.7)	480
BMP41, 51, 53	Fig. 29	M-49-422	B-422	Polyester	BK on WT	1.000 (25.4)	1.000 (25.4)	260
BMP41, 51, 53	Fig. 33	MC1-1000-422	B-422	Polyester	BK on WT	1.000 (25.4)	25 ft. (7.6 m)	1 roll (cont.)
BMP41, 51, 53	Fig. 29	M-89-422	B-422	Polyester	BK on WT	1.500 (38.1)	0.500 (12.7)	180
BMP41, 51, 53	Fig. 29	M-90-422	B-422	Polyester	BK on WT	1.500 (38.1)	0.750 (19.1)	180
<b>B-483 – Ultra Aggressive Adhesive Polyester Material</b>								
BMP41, 51, 53	Fig. 29	M-47-483	B-483	Polyester	BK on WT	1.000 (25.4)	0.500 (12.7)	480
BMP41, 51, 53	Fig. 29	M-60-483	B-483	Polyester	BK on WT	2.000 (50.8)	1.000 (25.4)	140
<b>B-499 – Nylon Cloth Labels</b>								
BMP41, 51, 53	Fig. 33	MC-375-499	B-499	Nylon Cloth	BK on WT	0.375 (9.5)	16 ft. (4.9 m)	1 roll (cont.)
BMP41, 51, 53	Fig. 33	MC-500-499	B-499	Nylon Cloth	BK on WT	0.500 (12.7)	16 ft. (4.9 m)	1 roll (cont.)
BMP41, 51, 53	Fig. 29	M-11-499	B-499	Nylon Cloth	BK on WT	0.750 (19.1)	0.500 (12.7)	220
BMP41, 51, 53	Fig. 33	MC-750-499	B-499	Nylon Cloth	BK on WT	0.750 (19.1)	16 ft. (4.9 m)	1 roll (cont.)
BMP41, 51, 53	Fig. 29	M-130-499	B-499	Nylon Cloth	BK on WT	0.825 (20.9)	0.375 (9.5)	220
BMP41, 51, 53	Fig. 29	M-84-499	B-499	Nylon Cloth	BK on WT	0.900 (22.8)	0.500 (12.7)	200
BMP41, 51, 53	Fig. 29	M-131-499	B-499	Nylon Cloth	BK on WT	1.000 (25.4)	0.500 (12.7)	180
BMP41, 51, 53	Fig. 29	M-128-499	B-499	Nylon Cloth	BK on WT	1.000 (25.4)	1.900 (48.3)	100
<b>B-584 – Reflective Tape</b>								
BMP41, 51, 53	Fig. 33	MC-500-584	B-584	Reflective	BK on WT	0.500 (12.7)	20 ft. (6.1 m)	1 roll (cont.)
BMP41, 51, 53	Fig. 33	MC-750-584	B-584	Reflective	BK on WT	0.750 (19.1)	20 ft. (6.1 m)	1 roll (cont.)
BMP41, 51, 53	Fig. 33	MC-500-584-YL	B-584	Reflective	BK on YL	0.500 (12.7)	20 ft. (6.1 m)	1 roll (cont.)
BMP41, 51, 53	Fig. 33	MC-750-584-YL	B-584	Reflective	BK on YL	0.750 (19.1)	20 ft. (6.1 m)	1 roll (cont.)
<b>B-595 – Indoor/Outdoor Vinyl Tape</b>								
BMP41, 51, 53	Fig. 33	MC-500-595-RD-WT	B-595	Vinyl	WT on RD*	0.500 (12.7)	25 ft. (7.6 m)	1 roll (cont.)
BMP41, 51, 53	Fig. 33	MC-750-595-RD-WT	B-595	Vinyl	WT on RD*	0.750 (19.1)	25 ft. (7.6 m)	1 roll (cont.)
BMP41, 51, 53	Fig. 33	MC1-1000-595-RD-WT	B-595	Vinyl	WT on RD*	1.000 (25.4)	25 ft. (7.6 m)	1 roll (cont.)

\* For additional general purpose tapes, refer to the Indoor/Outdoor Grade Facility and Safety Labels on page 295.



## Equipment, Component, Panel and Rating Plate Labels (B-422, B-428, B-483, B-499 and B-595)

Variety of durable materials ideal for marking backer boards, DIN rail, relays, PLCs, switches and solenoids. Create serial or rating plates with barcodes, graphics and more with a flexible high-tack adhesive for easy and long-lasting adhesion.

**B-422 Polyester Material** - Permanent adhesive, good for powder-coated/textured surfaces. Best on flat surfaces. Temp. Range: -40°F to 212°F (-40°C to 100°C). UL recognized.

**B-428 Metalized Polyester Material** - Permanent adhesive, silver finish. Temp. Range: -40°F to 176°F (-40°C to 80°C). UL recognized.

**B-483 Polyester Material** - Permanent adhesive for powder-coated/textured surfaces. Best on flat surfaces Temp. Range: -40°F to 248°F (-40°C to 120°C). UL recognized.

**B-499 Nylon Cloth Material** - Permanent adhesive. Pliable for rough or smooth surfaces. Temp. Range: -94°F to 194°F (-70°C to 90°C). UL recognized.

**B-595 Indoor/Outdoor Vinyl Material** - Permanent adhesive, very pliable, good for rough surfaces and outdoor use, wide range of colors. Temp. Range: -40°F to 248°F (-40°C to 120°C). UL recognized.

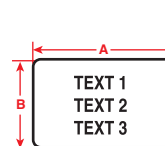

Figure 29



Figure 33

Fits Printer Models	Diagram	Catalog #	B#	Material	Color	Label Width A Inch (mm)	Label Height B Inch (mm)	Labels/Roll
<b>B-422 – Polyester Material</b>								
BMP41, 51, 53	Fig. 33	MC-375-422	B-422	Polyester	BK on WT	0.375 (9.5)	25 ft (7.6 m)	1 roll (cont.)
BMP41, 51, 53	Fig. 33	MC-475-422	B-422	Polyester	BK on WT	0.475 (12.1)	25 ft (7.6 m)	1 roll (cont.)
BMP41, 51, 53	Fig. 29	M-7-422	B-422	Polyester	BK on WT	0.500 (12.7)	0.500 (12.7)	280
BMP41, 51, 53	Fig. 33	MC-500-422	B-422	Polyester	BK on WT	0.500 (12.7)	25 ft (7.6 m)	1 roll (cont.)
BMP41, 51, 53	Fig. 33	MC-625-422	B-422	Polyester	BK on WT	0.625 (15.8)	25 ft (7.6 m)	1 roll (cont.)
BMP41, 51, 53	Fig. 29	M-47-422	B-422	Polyester	BK on WT	1.000 (25.4)	0.500 (12.7)	480
BMP41, 51, 53	Fig. 29	M-49-422	B-422	Polyester	BK on WT	1.000 (25.4)	1.000 (25.4)	260
BMP41, 51, 53	Fig. 33	MC1-1000-422	B-422	Polyester	BK on WT	1.000 (25.4)	25 ft (7.6 m)	1 roll (cont.)
BMP41, 51, 53	Fig. 29	M-89-422	B-422	Polyester	BK on WT	1.500 (38.1)	0.500 (12.7)	180
BMP41, 51, 53	Fig. 29	M-90-422	B-422	Polyester	BK on WT	1.500 (38.1)	0.750 (19.1)	180
<b>B-428 – Metalized Polyester Material</b>								
BMP41, 51, 53	Fig. 29	M-47-428	B-422	Polyester	BK on SV	1.000 (25.4)	0.500 (12.7)	480
BMP41, 51, 53	Fig. 29	M-92-428-BB	B-422	Polyester	BK on SV	1.130 (28.7)	0.500 (12.7)	239
BMP41, 51, 53	Fig. 29	M-60-428	B-422	Polyester	BK on SV	2.000 (50.8)	1.000 (25.4)	140
<b>B-483 – Ultra Aggressive Adhesive Polyester</b>								
BMP41, 51, 53	Fig. 29	M-60-483	B-422	Polyester	BK on WT	2.000 (50.8)	1.000 (25.4)	140
<b>B-499 – Nylon Cloth Material</b>								
BMP41, 51, 53	Fig. 33	MC-375-499	B-499	Nylon Cloth	BK on WT	0.375 (9.5)	16 ft (4.9 m)	1 roll (cont.)
BMP41, 51, 53	Fig. 33	MC-500-499	B-499	Nylon Cloth	BK on WT	0.500 (12.7)	16 ft (4.9 m)	1 roll (cont.)
BMP41, 51, 53	Fig. 33	M-11-499	B-499	Nylon Cloth	BK on WT	0.750 (19.1)	0.500 (12.7)	1 roll (cont.)
BMP41, 51, 53	Fig. 33	MC-750-499	B-499	Nylon Cloth	BK on WT	0.750 (19.1)	16 ft (4.9 m)	1 roll (cont.)
BMP41, 51, 53	Fig. 33	M-130-499	B-499	Nylon Cloth	BK on WT	0.825 (20.9)	0.375 (9.5)	1 roll (cont.)
BMP41, 51, 53	Fig. 33	M-84-499	B-499	Nylon Cloth	BK on WT	0.900 (22.8)	0.500 (12.7)	1 roll (cont.)
BMP41, 51, 53	Fig. 33	M-131-499	B-499	Nylon Cloth	BK on WT	1.000 (25.4)	0.500 (12.7)	1 roll (cont.)
BMP41, 51, 53	Fig. 33	M-128-499	B-499	Nylon Cloth	BK on WT	1.000 (25.4)	1.900 (48.3)	1 roll (cont.)
<b>B-595 – Indoor/Outdoor Vinyl Material</b>								
BMP41, 51, 53	Fig. 33	MC-500-595-OR-BK	B-595	Vinyl	BK on OR*	0.500 (12.7)	25 ft (7.6 m)	1 roll (cont.)
BMP41, 51, 53	Fig. 33	MC-750-595-OR-BK	B-595	Vinyl	BK on OR*	0.750 (19.1)	25 ft (7.6 m)	1 roll (cont.)
BMP41, 51, 53	Fig. 33	MC1-1000-595-OR-BK	B-595	Vinyl	BK on OR*	1.000 (25.4)	25 ft (7.6 m)	1 roll (cont.)

\* For additional general purpose tapes, refer to the Indoor/Outdoor Grade Facility and Safety Labels on page 295.



### BMP®41 Magnet Accessory Available

The BMP®41 printer offers a heavy-duty magnet accessory that allows you to go hands-free. Apply the magnet to the back of your printer and then stick it to a magnetized surface or wall.



# BMP®41 Materials

BradyID.com/bmp41

## Self-Laminating Vinyl Wire & Cable Markers (B-427)

Feature a clear, non printable area that wraps around wires and cables to serve as an overlaminate. These markers are designed to adhere to highly curved surfaces, wires and cables.

**B-427 Self-Laminating Vinyl Material** - Resistant to abrasion, water, oil and solvents. Temp range -40°F to 158°F (-40°C to 70°C), UL recognized.

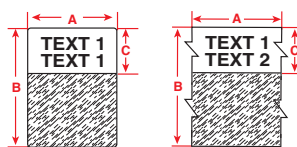
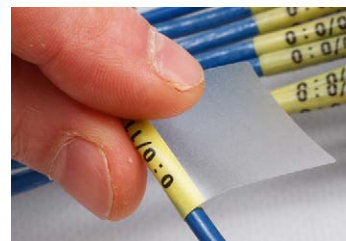

Figure 32

Figure 42



Fits Printer Models	Diagram	Catalog#	Color	Approx. Wire Gauge*	Max Wire Dia. Inch (mm)	Label Width A Inch (mm)	Label Height B Inch (mm)	Print-On Height C Inch (mm)	Labels/Roll	Sized To Fit
BMP41, 51, 53	Fig. 32	M-11-427	BK on WT	16 - 10 Gauge	0.160 (4.1)	0.500 (12.7)	0.750 (19.1)	0.375 (9.5)	360	CAT-6, 4 pair UTP Copper
BMP41, 51, 53	Fig. 32	M-136-427	BK on WT	16 - 10 Gauge	0.160 (4.1)	1.000 (25.4)	0.750 (19.1)	0.375 (9.5)	340	CAT-6, 4 pair UTP Copper
BMP41, 51, 53	Fig. 42	MC-750-427	BK on WT	16 - 10 Gauge	0.270 (6.7)	0.750 (19.1)	25 ft (7.6 m)	0.375 (9.5)	1 roll (cont.)	CAT-6, 4 pair UTP Copper
BMP41, 51, 53	Fig. 32	M-47-427	BK on WT	12 - 10 Gauge	0.210 (5.3)	1.000 (25.4)	0.500 (12.7)	0.375 (9.5)	360	2 pair Fiber/Coaxial, Single/Multi-Mode
BMP41, 51, 53	Fig. 32	M-48-427	BK on WT	12 - 10 Gauge	0.210 (5.3)	1.000 (25.4)	0.750 (19.1)	0.375 (9.5)	200	CAT-6, 4 pair UTP Copper, Fiber, Coaxial
BMP41, 51, 53	Fig. 32	M-49-427	BK on WT	12 - 10 Gauge	0.210 (5.3)	0.750 (19.1)	1.000 (25.4)	0.375 (9.5)	260	2 pair Fiber/Coaxial, Single/Multi-Mode
BMP41, 51, 53	Fig. 32	M-102-427	BK on WT	10 - 4 Gauge	0.270 (6.7)	0.500 (12.7)	1.250 (31.7)	0.375 (9.5)	200	CAT-6, 4 pair UTP Copper
BMP41, 51, 53	Fig. 32	M-143-427	BK on WT	10 - 4 Gauge	0.270 (6.7)	1.000 (25.4)	1.250 (31.7)	0.500 (12.7)	200	CAT-6, 4 pair UTP Copper, Fiber, Coaxial
BMP41, 51, 53	Fig. 32	M-89-427	BK on WT	10 - 4 Gauge	0.320 (8.1)	0.500 (12.7)	1.500 (38.1)	0.500 (12.7)	180	CAT-6, 4 pair UTP Copper
BMP41, 51, 53	Fig. 32	M-90-427	BK on WT	10 - 4 Gauge	0.320 (8.1)	0.750 (19.1)	1.500 (38.1)	0.500 (12.7)	180	CAT-6, 4 pair UTP Copper
BMP41, 51, 53	Fig. 32	M-91-427	BK on WT	10 - 4 Gauge	0.320 (8.1)	1.000 (25.4)	1.500 (38.1)	0.500 (12.7)	180	CAT-6, 4 pair UTP Copper, Fiber, Coaxial
BMP41, 51, 53	Fig. 32	M-51-427	BK on WT	3 Gauge - 2/0	0.530 (13.5)	1.000 (25.4)	2.500 (63.5)	0.750 (19.1)	110	25 pair Copper, 4-12 pair Fiber, Coaxial
BMP41, 51, 53	Fig. 32	M-53-427	BK on WT	3/0 - 400 kcmil	0.850 (21.6)	1.000 (25.4)	4.000 (101.6)	1.000 (25.4)	70	50 pair Copper, 24 pair Fiber, Backbone
BMP41, 51, 53	Fig. 32	M-91-427-YL	BK on YL	10 - 4 Gauge	0.320 (8.1)	1.000 (25.4)	1.500 (38.1)	0.500 (12.7)	180	CAT-6, 4 pair UTP Copper, Fiber, Coaxial
BMP41, 51, 53	Fig. 32	M-51-427-YL	BK on YL	3 Gauge - 2/0	0.530 (13.5)	1.000 (25.4)	2.500 (63.5)	0.750 (19.1)	110	25 pair Copper, 4-12 pair Fiber, Coaxial
BMP41, 51, 53	Fig. 32	M-53-427-YL	BK on YL	3/0 - 400 kcmil	0.850 (21.6)	1.000 (25.4)	4.000 (101.6)	1.000 (25.4)	70	50 pair Copper, 24 pair Fiber, Backbone

## PermaSleeve® PS Wire Marking Sleeves (B-342)

These heat-shrink sleeves are the ultimate in marker durability, permanence and aesthetic appearance. Fast shrink rate saves time and costs during installation. PermaSleeve® wire markers are available as individual die cut markers or continuous cut to length tubing. The 3:1 heat shrinkable sleeve fits snugly around your wire.

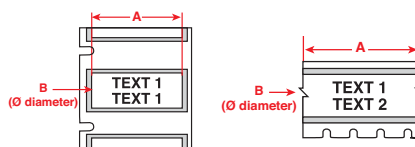

Figure 44

Figure 58



Fits Printer Models	Diagram	Catalog #	B#	Color	Approx. Wire Gauge*	For Wire Diameters Inch (mm) Min. Max	Supplied Width A Inch (mm)	Supplied Diameter B Inch (mm)	Sleeves/Roll
BMP41, 51, 53	Fig. 21	M-125-075-342	B-342	BK on WT	22-16 Gauge	0.046 - 0.110 (1.2 - 2.8)	0.750 (19.1)	0.235 (5.9)	80
BMP41, 51, 53	Fig. 58	MC-125-342	B-342	BK on WT	22-16 Gauge	0.046 - 0.110 (1.2 - 2.8)	7 ft (2.1 m)	0.235 (5.9)	1 roll (cont.)
BMP41, 51, 53	Fig. 21	M-187-075-342	B-342	BK on WT	20-10 Gauge	0.062 - 0.150 (1.6 - 3.8)	0.750 (19.1)	0.335 (8.5)	80
BMP41, 51, 53	Fig. 58	MC-187-342	B-342	BK on WT	20-10 Gauge	0.062 - 0.150 (1.6 - 3.8)	7 ft (2.1 m)	0.335 (8.5)	1 roll (cont.)
BMP41, 51, 53	Fig. 21	M-250-075-342	B-342	BK on WT	16-8 Gauge	0.094 - 0.215 (2.4 - 5.5)	0.750 (19.1)	0.439 (11.1)	80
BMP41, 51, 53	Fig. 58	MC-250-342	B-342	BK on WT	16-8 Gauge	0.094 - 0.215 (2.4 - 5.5)	7 ft (2.1 m)	0.439 (11.1)	1 roll (cont.)
BMP41, 51, 53	Fig. 21	M-375-075-342	B-342	BK on WT	12-4 Gauge	0.125 - 0.320 (3.2 - 8.1)	0.750 (19.1)	0.645 (16.4)	80
BMP41, 51, 53	Fig. 58	MC1-375-342	B-342	BK on WT	12-4 Gauge	0.125 - 0.320 (3.2 - 8.1)	7 ft (2.1 m)	0.645 (16.4)	1 roll (cont.)
BMP41, 51, 53	Fig. 58	MC-125-342-YL	B-342	BK on YL	22-16 Gauge	0.046 - 0.110 (1.2 - 2.8)	7 ft (2.1 m)	0.235 (5.9)	1 roll (cont.)
BMP41, 51, 53	Fig. 58	MC-187-342-YL	B-342	BK on YL	20-10 Gauge	0.062 - 0.150 (1.6 - 3.8)	7 ft (2.1 m)	0.335 (8.5)	1 roll (cont.)
BMP41, 51, 53	Fig. 58	MC-250-342-YL	B-342	BK on YL	16-8 Gauge	0.094 - 0.215 (2.4 - 5.5)	7 ft (2.1 m)	0.439 (11.1)	1 roll (cont.)

## Nylon Cloth Cable Flags (B-499)

Pre-formatted with two printable areas, allowing label to be easily folded around wires to create a two-sided, printed flag.

**B-499 Nylon Cloth Material** - Permanent adhesive. Pliable for rough or smooth surfaces. Temp. Range: -94°F to 194°F (-70°C to 90°C). UL recognized.

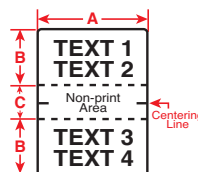
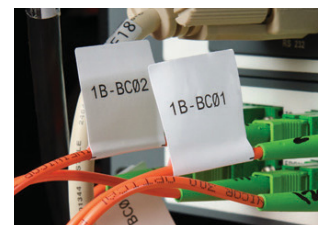

Figure 63



Fits Printer Models	Diagram	Catalog #	B#	Material	Color	Label Width A Inch (mm)	Label Height B Inch (mm)	Non-Print Area Inch (mm)	Labels/Roll
BMP41, 51, 53	Fig. 63	M-141-499	B-499	Nylon Cloth	BK on WT	1.000 (25.4)	1.000 (25.4)	0.250 (6.3)	90

## Vinyl Cloth Adhesive Wire & Cable Wraps (B-498)

Printer automatically repeats your text to fill the label for maximum readability. Repositionable vinyl cloth material's special adhesive stays put, but marker can be removed and reapplied if necessary. Temp Range -40°F to 175°F (-40°C to 70°C). UL Recognized.

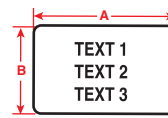

Figure 29



Fits Printer Models	Diagram	Catalog #	B#	Material	Color	Approx. Wire Gauge*	Max. Wire Dia. Inch (mm)	Label Width A Inch (mm)	Label Height B Inch (mm)	Labels/Roll
BMP41, 51, 53	Fig. 29	M-7-498	B-498	Vinyl	BK on WT	22 - 16 Gauge	0.110 (2.8)	0.500 (12.7)	0.500 (12.7)	240
BMP41, 51, 53	Fig. 29	M-163-498	B-498	Vinyl	BK on WT	12 - 10 Gauge	0.210 (5.3)	0.500 (12.7)	1.000 (25.4)	180
BMP41, 51, 53	Fig. 29	M-11-498	B-498	Vinyl	BK on WT	16 - 10 Gauge	0.160 (4.1)	0.750 (19.1)	0.500 (12.7)	220
BMP41, 51, 53	Fig. 29	M-131-498	B-498	Vinyl	BK on WT	10 - 4 Gauge	0.270 (6.7)	1.000 (25.4)	0.500 (12.7)	180
BMP41, 51, 53	Fig. 29	M-48-498	B-498	Vinyl	BK on WT	12 - 10 Gauge	0.210 (5.3)	1.000 (25.4)	0.750 (19.1)	180
BMP41, 51, 53	Fig. 29	M-49-498	B-498	Vinyl	BK on WT	12 - 10 Gauge	0.210 (5.3)	1.000 (25.4)	1.000 (25.4)	160
BMP41, 51, 53	Fig. 29	M-91-498	B-498	Vinyl	BK on WT	10 - 4 Gauge	0.270 (6.7)	1.500 (38.1)	1.000 (25.4)	120

## Patch Panel, Punch Block, Desi Strip and Faceplate Labels (B-412, and B-422)

Create a fully-formatted serialized punch block label to fit your equipment or label your ports, jacks and outlets with adhesive labels or slide-in strips.

**B-412 Polypropylene Tags** - Non-Adhesive Slide-in Strips

**B-422 Polyester Material** - Permanent adhesive, good for powder-coated/textured surfaces. Temp. Range: -40°F to 212°F (-40°C to 100°C). UL recognized.

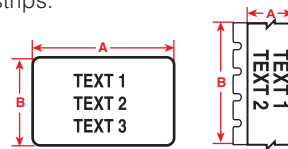

Figure 29

Figure 33



Fits Printer Models	Diagram	Catalog #	B#	Material	Color	Label Width A Inch (mm)	Roll Length B Inch (mm)	Labels/Roll
<b>B-412 Polypropylene Tags</b>								
BMP41, 51, 53	Fig. 33	MC-375-412	B-412	Polypropylene	BK on WT	0.375 (9.5)	20 ft (6.1 m)	1 roll (cont.)
BMP41, 51, 53	Fig. 33	MC-475-412	B-412	Polypropylene	BK on WT	0.475 (12.1)	20 ft (6.1 m)	1 roll (cont.)
BMP41, 51, 53	Fig. 33	MC-625-412	B-412	Polypropylene	BK on WT	0.625 (15.8)	20 ft (6.1 m)	1 roll (cont.)
<b>B-422 Polyester Material</b>								
BMP41, 51, 53	Fig. 33	MC-375-422	B-422	Polyester	BK on WT	0.375 (9.5)	25 ft (7.6 m)	1 roll (cont.)
BMP41, 51, 53	Fig. 33	MC-475-422	B-422	Polyester	BK on WT	0.475 (12.1)	25 ft (7.6 m)	1 roll (cont.)
BMP41, 51, 53	Fig. 29	M-7-422	B-422	Polyester	BK on WT	0.500 (12.7)	0.500 (12.7)	280
BMP41, 51, 53	Fig. 29	M-89-422	B-422	Polyester	BK on WT	0.500 (12.7)	1.500 (38.1)	180
BMP41, 51, 53	Fig. 29	M-90-422	B-422	Polyester	BK on WT	0.750 (19.1)	1.500 (38.1)	180
BMP41, 51, 53	Fig. 29	M-47-422	B-422	Polyester	BK on WT	1.000 (25.4)	0.500 (12.7)	480

## Terminal Block Adhesive Strips (B-498)

When using terminal block mode, printer will serialize and pre-space to your terminal spacing.

**B-498 Repositionable Vinyl Cloth Material** - Printer automatically repeats your text to fill the label for maximum readability. Special adhesive stays put, but marker can be removed and reapplied if necessary. Temp Range -40°F to 175°F (-40°C to 70°C). UL Recognized.



Figure 33

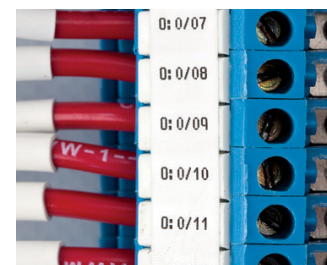

Fits Printer Models	Diagram	Catalog #	B#	Material	Color	Label Width A Inch (mm)	Roll Length B Inch (mm)	Labels/Roll
BMP41, 51, 53	Fig. 33	MC-240-498	B-498	Vinyl	BK on WT	0.240 (6.1)	16 ft (4.9 m)	1 roll (cont.)
BMP41, 51, 53	Fig. 33	MC-318-498	B-498	Vinyl	BK on WT	0.318 (8.1)	16 ft (4.9 m)	1 roll (cont.)
BMP41, 51, 53	Fig. 33	MC-375-498	B-498	Vinyl	BK on WT	0.375 (9.5)	16 ft (4.9 m)	1 roll (cont.)



# BMP®51 and BMP®53 Label Makers

BradyID.com/bmp51

Portable Printers



**BMP®51**  
LABEL MAKER

**BMP®53**  
LABEL MAKER



## Made to get the job done.

Print continuous and die cut labels up to 1.5" wide and with more material options.

- Ribbon and label materials in one easy to load cartridge
- Fast print speed. Prints 1 inch per second!
- More than 200 label parts in 14 material types
- 1" sleeves and 1.5" wide continuous output
- Material recognition and automatic label formatting
- Large, graphical display with backlight
- Durable built-in cutter with label retention
- Compatibility with LabelMark™ software for advanced label design and data importation
- Built-in Bluetooth® technology or optional Wi-Fi card for wireless printing via a network
- Continuous and die-cut label materials available
- Tough, durable label materials that won't fade, smear or fall off



### View Online!

Visit [BradyID.com/bmp51](http://BradyID.com/bmp51) for more information on the BMP®51 and BMP®53 label printers.

### Your Complete Printing Solution:

BMP®51 & BMP®53 cartridges with label and print ribbon..... page 302



BMP®51 Label Maker

### Don't need the keyboard or screen?

Check out the BMP®53 Label Maker - many of the same features as the BMP®51 Label Maker, minus the display screen and keyboard.

- Create labels with LabelMark™ or CodeSoft™ Software, or using a Brady Mobile App on your smart phone
- Use the same label cartridges as BMP51

### BMP®51 & BMP®53 Label Printers

Catalog #	Description
BMP51	BMP51 Printer, Rechargeable Li-Ion Battery Pack and AC Adaptor/Battery Charger*
BMP51-KIT-AC	BMP51 Printer with AC Adaptor/Battery Charger*
BMP51-KIT-LMK	BMP51 Printer, LabelMark Software and AC Adaptor*
BMP53	BMP53 Peripheral Printer with AC Adaptor*
BMP53-KIT-AC-BP	BMP53 Printer, Rechargeable Li-Ion Battery Pack and AC Adaptor/Battery Charger*
BMP53-KIT-LMK	BMP53 Printer, LabelMark Software and AC

\* Printer ships with Hard Carrying Case, Battery Tray for AA batteries, USB Cable, Drivers CD, Product CD, Quick Start Guide, and one MC-1500-595-WT-BK. BMP53 printer also ships with a pre-installed WiFi network card. Network cards for BMP51 printer sold separately.

Patents applied for: 6,732,619 and 7,070,347 on the BMP51 and BMP53 Label Makers. 6,929,415 on the PermaSleeve® cartridges. 8,542,155 on wireless and ethernet cards.

### Accessories

Catalog #	Description
M50-MAGNET	BMP50 Series Magnet Accessory
BMP-UBP	Lithium Ion Rechargeable Battery Pack for Mobile Printers
BMP-UBP-AC	Lithium Ion Rechargeable Battery Pack with AC Adaptor/Battery Charger
142267	Brady Network Card - Ethernet only
142268	Brady Network Card - WiFi + Ethernet
M50-HC	BMP50 Series Hard Carrying Case
M50-SC	BMP50 Series Soft Carrying Case
M-AC-143110	BMP50 Series AC Adaptor/Battery Charger
M50-CABLE	BMP50 Series USB Cable
M50-BATT-TRAY	BMP50 Series Spare Battery Tray
LM5STD CD	LabelMark Standard Software - CD-ROM

## Get the job done FASTER, EASIER and WITH CONFIDENCE.

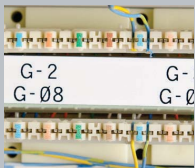

Voice & Data Communications



PermaSleeve® Wire Marking Sleeves



Product Identification



Facility & Safety Identification



Laboratory Identification



General ID ...and many more!

# BMP®51 and BMP®53 Label Makers

BradyID.com/bmp51

	BMP®53 Printer Specifications	BMP®51 Printer Specifications
<b>Max Labels Per Day</b>	Average 500 labels/day	Average 500 labels/day
<b>Print Resolution</b>	300 dpi	300 dpi
<b>Print Technology</b>	Thermal Transfer	Thermal Transfer
<b>Print Speed</b>	25.4mm/sec (1/sec)	25.4mm/sec (1/sec)
<b>Tape Widths (inches)</b>	Various sizes from 0.235" to 1.50"	Various sizes from 0.235" to 1.50"
<b>Tape Widths (mm)</b>	Various sizes from 6.4 mm to 38.1 mm	Various sizes from 6.4 mm to 38.1 mm
<b>Max Label Width</b>	1.50" (38.1mm)	1.50" (38.1mm)
<b>Max Print Width</b>	1.44" (36.6 mm)	1.44" (36.6 mm)
<b>Memory</b>	48 MB / Up to 25,000 Labels	48 MB / Up to 25,000 Labels
<b>Materials Supported</b>	M-, MC-, MC1- Series Cartridges (all sizes) 140+ Stock Parts	M-, MC-, MC1- Series Cartridges (all sizes) 140+ Stock Parts
<b>Continuous vs Die Cut Labels</b>	Continuous and die cut labels	Continuous and die cut labels
<b>PC Connectivity</b>	Yes	Yes
<b>Software Compatibility</b>	USB, WiFi, LAN	USB, WiFi, LAN
<b>Data Transfer from PC to printer</b>	LabelMark® / CodeSoft™ Software	LabelMark® / CodeSoft™ Software
<b>Wireless Connectivity</b>	Yes, with Labelmark® Software	Yes, with Labelmark® Software
<b>Stand Alone Printing</b>	Yes	Yes
<b>Connectivity Options</b>	No	Yes
<b>Color Capability</b>	Single print color on a label	Single print color on a label
<b>Keyboard</b>	Not Applicable	QWERTY
<b>Backlit Screen</b>	Not Applicable	2.7" x 1.7", backlit
<b>Text Sizes</b>	4 to 103pt + autosizing	4 to 103pt + autosizing
<b>Multi-Line Print</b>	Yes	Yes
<b>Print Rotation</b>	Yes	Yes
<b>Serialization</b>	Yes	Yes
<b>Barcode</b>	39 and 128	39 and 128
<b>Symbols</b>	450	450
<b>Portability</b>	Yes	Yes
<b>Label Types or Application Functions</b>	BMP51 and BMP53 Printers: Polyester, Polyethylene Tag, Permasleeve® Heat Shrinking Tube, Tamper-Evident Vinyl, Polypropylene Tag, Permanent Polypropylene, Self-Laminating vinyl, Metallized Polyester, Self-Laminating Polyester, Staingerbondz™ Labels, Tissue Cassette Polyester, Ultra aggressive Polyester, High Performance Polyester, Freezerbondz™ Labels, Repositionable Vinyl Cloth, Reflective Tap, Indoor/Outdoor Vinyl	
<b>Applications</b>	BMP51 and BMP53 Printers: Data Communications Labeling, Facility, Safety & Maintenance Identification, General & Industrial Labeling, Laboratory Identification, Panel Identification, Security Identification, Wire & Cable Marking	
<b>Power Supply</b>	AA Alkaline batteries (8), AC Power, or rechargeable lithium ion battery	AA Alkaline batteries (8), AC Power, or rechargeable lithium ion battery
<b>Weight</b>	2.6 lbs (1.2 kg)	2.6 lbs (1.2 kg)
<b>Warranty</b>	2 years	2 years

## LabelMark™ Software

Use LabelMark™ Software to create labels and print them on your BMP®51 and BMP®53 printer using the supplied USB cable. LabelMark allows users to integrate data sources, design labels and even batch print all from one PC-based program. This user-friendly label design and printing software is ideal for electrical, wire ID, datacomm and product ID applications.



### Label set up and data management features

- Electrical labeling wizards for control panel, 110 Block, and wire harness assembly
- Select template for datacomm labeling by manufacturer/model
- Manage multiple files in a single job by grouping wire markers, push buttons, rating plates, and terminal block labels into one job file
- Complete integration with Microsoft Office® and AutoCAD applications

### Print labels faster and more efficiently

- Print labels simultaneously on multiple printers for fast label kitting
- Design fixed text labels for quick printing or free form labels for custom label design

## Network your Printer

The BMP®51 and BMP®53 printer connect to your PC via the included USB cable. To avoid use of a physical cable, network cards are available for the printers.



**BMP51 printer** is compatible with two optional field-installable network cards:

- Ethernet Only Card (catalog #: 142267)
- WiFi + Ethernet (catalog #: 142268)



**BMP®53 Printer** is a PC-connect only printer and ships with the Ethernet Only Card pre-installed. The WiFi + Ethernet card is available separately and can be field installed.

## Away from your PC? Use the Mobile Apps for Android

“Brady Mobile” - the first mobile Brady apps for on-the-job label making. Simply download the Brady Mobile app on your Android phone to:

- Design a label or edit an existing label
- Create and edit label templates
- Print to BMP®51 or BMP®53 Printers using WiFi direct technology
- Save label files to your mobile device
- Built-in barcodes, symbols and pictograms that you can insert onto your labels
- Automatically updates when new label types, printers and materials are available



### To Download the Mobile Apps:

Open Google Play on your mobile device and search for “Brady Mobile.”

*Brady Mobile App is designed to run on Android OS Version 2.2 or higher.*

Android is a trademark of Google Inc.  
Bluetooth® is a registered trademark of Bluetooth SIG, Inc.  
Microsoft Office is a registered trademark of Microsoft Corporation.



# BMP®51 and BMP®53 Materials

BradyID.com/bmp51

## Indoor / Outdoor Vinyl Material (B-595)

Pliable vinyl with highly aggressive adhesive conforms well to smooth or rough surfaces such as pipes, panels, shelving, bins, and equipment. Ideal for production ID and lean 5S labeling. Excellent resistance to oils, detergents, dirt, grime, and many solvents. Label last up to 8-10 years outdoors.



Figure 33



Portable Printers

Fits Printer Model	Diagram	Catalog #	B#	Material	Color	Label Width A Inch (mm)	Roll Length B Inch (mm)	Labels/Roll
<b>B-595 – Indoor / Outdoor Vinyl Tape</b>								
BMP41, 51, 53	Fig. 33	MC-500-595-WT-BK	B-595	Vinyl	BK on WT	0.500 (12.70)	25 ft. (7.62 m)	1 roll (cont.)
BMP41, 51, 53	Fig. 33	MC-750-595-WT-BK	B-595	Vinyl	BK on WT	0.750 (19.10)	25 ft. (7.62 m)	1 roll (cont.)
BMP41, 51, 53	Fig. 33	MC1-1000-595-WT-BK	B-595	Vinyl	BK on WT	1.000 (25.40)	25 ft. (7.62 m)	1 roll (cont.)
BMP51, 53	Fig. 33	MC-1500-595-WT-BK	B-595	Vinyl	BK on WT	1.500 (38.10)	25 ft. (7.62 m)	1 roll (cont.)
BMP41, 51, 53	Fig. 33	MC-500-595-YL-BK	B-595	Vinyl	BK on YL	0.500 (12.70)	25 ft. (7.62 m)	1 roll (cont.)
BMP41, 51, 53	Fig. 33	MC-750-595-YL-BK	B-595	Vinyl	BK on YL	0.750 (19.10)	25 ft. (7.62 m)	1 roll (cont.)
BMP41, 51, 53	Fig. 33	MC1-1000-595-YL-BK	B-595	Vinyl	BK on YL	1.000 (25.40)	25 ft. (7.62 m)	1 roll (cont.)
BMP51, 53	Fig. 33	MC-1500-595-YL-BK	B-595	Vinyl	BK on YL	1.500 (38.10)	25 ft. (7.62 m)	1 roll (cont.)
BMP41, 51, 53	Fig. 33	MC-500-595-OR-BK	B-595	Vinyl	BK on OR	0.500 (12.70)	25 ft. (7.62 m)	1 roll (cont.)
BMP41, 51, 53	Fig. 33	MC-750-595-OR-BK	B-595	Vinyl	BK on OR	0.750 (19.10)	25 ft. (7.62 m)	1 roll (cont.)
BMP41, 51, 53	Fig. 33	MC1-1000-595-OR-BK	B-595	Vinyl	BK on OR	1.000 (25.40)	25 ft. (7.62 m)	1 roll (cont.)
BMP51, 53	Fig. 33	MC-1500-595-OR-BK	B-595	Vinyl	BK on OR	1.500 (38.10)	25 ft. (7.62 m)	1 roll (cont.)
BMP41, 51, 53	Fig. 33	MC-500-595-BL-WT	B-595	Vinyl	WT on BL	0.500 (12.70)	25 ft. (7.62 m)	1 roll (cont.)
BMP41, 51, 53	Fig. 33	MC-750-595-BL-WT	B-595	Vinyl	WT on BL	0.750 (19.10)	25 ft. (7.62 m)	1 roll (cont.)
BMP41, 51, 53	Fig. 33	MC1-1000-595-BL-WT	B-595	Vinyl	WT on BL	1.000 (25.40)	25 ft. (7.62 m)	1 roll (cont.)
BMP51, 53	Fig. 33	MC-1500-595-BL-WT	B-595	Vinyl	WT on BL	1.500 (38.10)	25 ft. (7.62 m)	1 roll (cont.)
BMP41, 51, 53	Fig. 33	MC-500-595-RD-WT	B-595	Vinyl	WT on RD	0.500 (12.70)	25 ft. (7.62 m)	1 roll (cont.)
BMP41, 51, 53	Fig. 33	MC-750-595-RD-WT	B-595	Vinyl	WT on RD	0.750 (19.10)	25 ft. (7.62 m)	1 roll (cont.)
BMP41, 51, 53	Fig. 33	MC1-1000-595-RD-WT	B-595	Vinyl	WT on RD	1.000 (25.40)	25 ft. (7.62 m)	1 roll (cont.)
BMP51, 53	Fig. 33	MC-1500-595-RD-WT	B-595	Vinyl	WT on RD	1.500 (38.10)	25 ft. (7.62 m)	1 roll (cont.)
BMP41, 51, 53	Fig. 33	MC-500-595-GN-WT	B-595	Vinyl	WT on GN	0.500 (12.70)	25 ft. (7.62 m)	1 roll (cont.)
BMP41, 51, 53	Fig. 33	MC-750-595-GN-WT	B-595	Vinyl	WT on GN	0.750 (19.10)	25 ft. (7.62 m)	1 roll (cont.)
BMP41, 51, 53	Fig. 33	MC1-1000-595-GN-WT	B-595	Vinyl	WT on GN	1.000 (25.40)	25 ft. (7.62 m)	1 roll (cont.)
BMP51, 53	Fig. 33	MC-1500-595-GN-WT	B-595	Vinyl	WT on GN	1.500 (38.10)	25 ft. (7.62 m)	1 roll (cont.)
BMP41, 51, 53	Fig. 33	MC-500-595-WT-RD	B-595	Vinyl	RD on WT	0.500 (12.70)	25 ft. (7.62 m)	1 roll (cont.)
BMP41, 51, 53	Fig. 33	MC-750-595-WT-RD	B-595	Vinyl	RD on WT	0.750 (19.10)	25 ft. (7.62 m)	1 roll (cont.)
BMP41, 51, 53	Fig. 33	MC1-1000-595-WT-RD	B-595	Vinyl	RD on WT	1.000 (25.40)	25 ft. (7.62 m)	1 roll (cont.)
BMP51, 53	Fig. 33	MC-1500-595-WT-RD	B-595	Vinyl	RD on WT	1.500 (38.10)	25 ft. (7.62 m)	1 roll (cont.)
BMP41, 51, 53	Fig. 33	MC-500-595-BK-WT	B-595	Vinyl	WT on BK	0.500 (12.70)	25 ft. (7.62 m)	1 roll (cont.)
BMP41, 51, 53	Fig. 33	MC-750-595-BK-WT	B-595	Vinyl	WT on BK	0.750 (19.10)	25 ft. (7.62 m)	1 roll (cont.)
BMP41, 51, 53	Fig. 33	MC1-1000-595-BK-WT	B-595	Vinyl	WT on BK	1.000 (25.40)	25 ft. (7.62 m)	1 roll (cont.)
BMP51, 53	Fig. 33	MC-1500-595-BK-WT	B-595	Vinyl	WT on BK	1.500 (38.10)	25 ft. (7.62 m)	1 roll (cont.)
BMP41, 51, 53	Fig. 33	MC-500-595-CL-BK	B-595	Vinyl	BK on CL	0.500 (12.70)	20 ft. (6.09 m)	1 roll (cont.)
BMP41, 51, 53	Fig. 33	MC-750-595-CL-BK	B-595	Vinyl	BK on CL	0.750 (19.10)	20 ft. (6.09 m)	1 roll (cont.)
BMP41, 51, 53	Fig. 33	MC1-1000-595-CL-BK	B-595	Vinyl	BK on CL	1.000 (25.40)	20 ft. (6.09 m)	1 roll (cont.)
BMP51, 53	Fig. 33	MC-1500-595-CL-BK	B-595	Vinyl	BK on CL	1.500 (38.10)	20 ft. (6.09 m)	1 roll (cont.)
BMP41, 51, 53	Fig. 33	MC-500-595-CL-WT	B-595	Vinyl	WT on CL	0.500 (12.70)	20 ft. (6.09 m)	1 roll (cont.)
BMP41, 51, 53	Fig. 33	MC-750-595-CL-WT	B-595	Vinyl	WT on CL	0.750 (19.10)	20 ft. (6.09 m)	1 roll (cont.)
BMP41, 51, 53	Fig. 33	MC1-1000-595-CL-WT	B-595	Vinyl	WT on CL	1.000 (25.40)	20 ft. (6.09 m)	1 roll (cont.)
BMP51, 53	Fig. 33	MC-1500-595-CL-WT	B-595	Vinyl	WT on CL	1.500 (38.10)	20 ft. (6.09 m)	1 roll (cont.)

## Reflective Material (B-584)

- Highly reflective material shines back brightly when struck by light
- Ideal for labeling outdoor utility poles and pedestals, hard hats, jobsite equipment and roof-top equipment
- Recommended for low light or inclement weather conditions

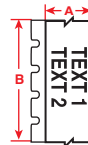

Figure 33



Fits Printer Model	Diagram	Catalog #	B#	Material	Color	Label Width A Inch (mm)	Roll Length B Inch (mm)	Labels/Roll
<b>B-584 – Reflective Tape</b>								
BMP41, 51, 53	Fig.33	MC-500-584	B-584	Reflective Tape	BK on WT	0.500 (12.70)	20 ft. (6.09 m)	1 roll (cont.)
BMP41, 51, 53	Fig.33	MC-750-584	B-584	Reflective Tape	BK on WT	0.750 (19.05)	20 ft. (6.09 m)	1 roll (cont.)
BMP41, 51, 53	Fig.33	MC-1000-584	B-584	Reflective Tape	BK on WT	1.000 (25.40)	20 ft. (6.09 m)	1 roll (cont.)
BMP51, 53	Fig.33	MC-1500-584	B-584	Reflective Tape	BK on WT	1.500 (38.10)	20 ft. (6.09 m)	1 roll (cont.)
BMP41, 51, 53	Fig.33	MC-500-584-YL	B-584	Reflective Tape	BK on YL	0.500 (12.70)	20 ft. (6.09 m)	1 roll (cont.)
BMP41, 51, 53	Fig.33	MC-750-584-YL	B-584	Reflective Tape	BK on YL	0.750 (19.05)	20 ft. (6.09 m)	1 roll (cont.)
BMP41, 51, 53	Fig.33	MC-1000-584-YL	B-584	Reflective Tape	BK on YL	1.000 (25.40)	20 ft. (6.09 m)	1 roll (cont.)
BMP51, 53	Fig.33	MC-1500-584-YL	B-584	Reflective Tape	BK on YL	1.500 (38.10)	20 ft. (6.09 m)	1 roll (cont.)

## Inside-Panel Component Labels for Automation & Electrical (B-422, B-428, B-483, B-499, B-595)

Various sizes, colors and label types for marking backboards, DIN rails, enclosures, relays, solenoids, switches, drive motors, and other components.

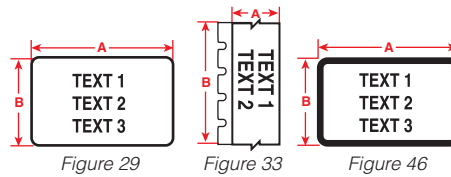

Fits Printer Model	Diagram	Catalog #	B#	Material	Color	Label Width A Inch (mm)	Label Height B Inch (mm)	Labels/Roll
<b>B-422 – Gloss Polyester</b>								
BMP41, 51, 53	Fig. 33	MC-375-422	B-422	Gloss Polyester	BK on WT	0.375 (9.5)	25 ft (7.6 m)	1 roll (cont.)
BMP41, 51, 53	Fig. 33	MC-475-422	B-422	Gloss Polyester	BK on WT	0.475 (12.1)	25 ft (7.6 m)	1 roll (cont.)
BMP41, 51, 53	Fig. 29	M-7-422	B-422	Gloss Polyester	BK on WT	0.500 (12.70)	0.500 (12.70)	280
BMP41, 51, 53	Fig. 33	MC-500-422	B-422	Gloss Polyester	BK on WT	0.500 (12.7)	25 ft (7.6 m)	1 roll (cont.)
BMP41, 51, 53	Fig. 29	M-47-422	B-422	Gloss Polyester	BK on WT	1.000 (25.40)	0.500 (12.70)	360
BMP41, 51, 53	Fig. 29	M-49-422	B-422	Gloss Polyester	BK on WT	1.000 (25.40)	1.000 (25.40)	200
BMP41, 51, 53	Fig. 33	MC1-1000-422	B-422	Gloss Polyester	BK on WT	1.000 (25.40)	25ft. (7.62m)	1 roll (cont.)
BMP41, 51, 53	Fig. 29	M-89-422	B-422	Gloss Polyester	BK on WT	1.500 (38.10)	0.500 (12.70)	360
BMP41, 51, 53	Fig. 29	M-90-422	B-422	Gloss Polyester	BK on WT	1.500 (38.10)	0.750 (19.05)	200
<b>B-428 – Metalized Polyester</b>								
BMP41, 51, 53	Fig. 29	M-47-428	B-428	Metalized Polyester	BK on SV	1.000 (25.40)	0.500 (12.70)	360
BMP41, 51, 53	Fig. 46	M-92-428-BB	B-428	Metalized Polyester	BK on SV	1.130 (28.70)	0.500 (12.70)	360
BMP51, 53	Fig. 29	M-30-428	B-428	Metalized Polyester	BK on SV	1.500 (38.10)	0.750 (19.05)	260
BMP51, 53	Fig. 29	M-29-428	B-428	Metalized Polyester	BK on SV	1.500 (38.10)	0.500 (12.70)	360
BMP41, 51, 53	Fig. 29	M-60-428	B-428	Metalized Polyester	BK on SV	2.000 (50.80)	1.000 (25.40)	80
<b>B-483 – Ultra Aggressive Polyester</b>								
BMP41, 51, 53	Fig. 29	M-47-483	B-483	Polyester	BK on WT	1.000 (25.4)	0.500 (12.7)	480
BMP41, 51, 53	Fig. 29	M-61-483	B-483	Polyester	BK on WT	2.000 (50.80)	0.500 (12.70)	80
BMP41, 51, 53	Fig. 29	M-60-483	B-483	Polyester	BK on WT	2.000 (50.80)	1.000 (25.40)	80
<b>B-499 – Nylon Cloth</b>								
BMP41, 51, 53	Fig. 29	M-11-499	B-499	Nylon Cloth	BK on WT	0.750 (19.05)	0.500 (12.70)	220
BMP41, 51, 53	Fig. 29	M-84-499	B-499	Nylon Cloth	BK on WT	0.900 (22.86)	0.500 (12.70)	200
BMP41, 51, 53	Fig. 33	M-131-499	B-499	Nylon Cloth	BK on WT	1.000 (25.4)	0.500 (12.7)	1 roll (cont.)
BMP51, 53	Fig. 29	M-132-499	B-499	Nylon Cloth	BK on WT	1.500 (38.10)	1.250 (31.75)	160
BMP41, 51, 53	Fig. 29	M-128-499	B-499	Nylon Cloth	BK on WT	1.900 (48.26)	1.000 (25.40)	100
<b>B-595 – Indoor / Outdoor Vinyl Tape*</b>								
BMP41, 51, 53	Fig. 33	MC-500-595-WT-BK	B-595	Vinyl	BK on WT	0.500 (12.70)	25 ft. (7.62 m)	1 roll (cont.)
BMP41, 51, 53	Fig. 33	MC1-1000-595-WT-BK	B-595	Vinyl	BK on WT	1.000 (25.40)	25 ft (7.62 m)	1 roll (cont.)
BMP41, 51, 53	Fig. 33	MC-500-595-YL-BK	B-595	Vinyl	BK on YL	0.500 (12.70)	25 ft. (7.62 m)	1 roll (cont.)
BMP41, 51, 53	Fig. 33	MC1-1000-595-YL-BK	B-595	Vinyl	BK on YL	1.000 (25.40)	25 ft. (7.62 m)	1 roll (cont.)
BMP41, 51, 53	Fig. 33	MC-500-595-OR-BK	B-595	Vinyl	BK on OR	0.500 (12.70)	25 ft. (7.62 m)	1 roll (cont.)
BMP41, 51, 53	Fig. 33	MC1-1000-595-OR-BK	B-595	Vinyl	BK on OR	1.000 (25.40)	25 ft (7.62 m)	1 roll (cont.)

\* For additional vinyl label colors, refer to the B-595 Indoor/Outdoor Grade Facility and Safety Labels on page 302.

## Terminal Block Adhesive Strips (B-498)

Specially-designed narrow-width markers. Set specific spacing and serialize the data by using LabelMark™ 6 Software, Brady Mobile App, or the built-in label templates in the BMP<sup>®</sup>51 printer can auto-serialize these labels to save you time.

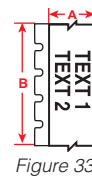

Figure 33



Fits Printer Model	Diagram	Catalog #	B#	Material	Color	Label Width A Inch (mm)	Roll Length B Inch (mm)	Labels/Roll
<b>B-498 – Vinyl Cloth</b>								
BMP41, 51, 53	Fig. 33	MC-240-498	B-498	Vinyl Cloth	BK on WT	0.240 (6.09)	16 ft. (4.87 m)	1 roll (cont.)
BMP41, 51, 53	Fig. 33	MC-318-498	B-498	Vinyl Cloth	BK on WT	0.318 (8.07)	16 ft. (4.87 m)	1 roll (cont.)
BMP41, 51, 53	Fig. 33	MC-375-498	B-498	Vinyl Cloth	BK on WT	0.375 (9.52)	16 ft. (4.87 m)	1 roll (cont.)



# BMP®51 and BMP®53 Materials

BradyID.com/bmp51

## Self-Laminating Vinyl Wire & Cable Labels (B-427)

Features a clear, non-printable "tail" that wraps around the wire and overlaminates the printed text. Protected print area offers superior resistance to handling, solvents, oil, grease, dirt and water. Available as individual die-cut markers or continuous cut-to-length labels.

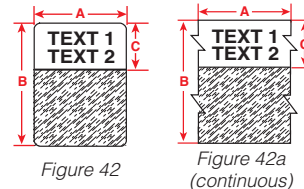

Portable Printers

Fits Printer Model	Diagram	Catalog #	B#	Material	Color	Approx. Wire Gauge	Max. Wire Diameter	Label Width A Inch (mm)	Label Height B Inch (mm)	Print-On Height C Inch (mm)	Labels/Roll
<b>B-427 – Self-Laminating Vinyl</b>											
BMP41, 51, 53	Fig. 42	M-11-427	B-427	Vinyl	BK on WT	16 - 10 Gauge	0.160" (4.06 mm)	0.500 (12.70)	0.750 (19.05)	0.375 (9.53)	360
BMP41, 51, 53	Fig. 42	M-136-427	B-427	Vinyl	BK on WT	16 - 10 Gauge	0.160" (4.06 mm)	1.000 (25.40)	0.750 (19.05)	0.375 (9.53)	200
BMP41, 51, 53	Fig. 42	M-47-427	B-427	Vinyl	BK on WT	12 - 10 Gauge	0.210" (5.33 mm)	0.500 (12.70)	1.000 (25.40)	0.375 (9.53)	360
BMP41, 51, 53	Fig. 42	M-48-427	B-427	Vinyl	BK on WT	12 - 10 Gauge	0.210" (5.33 mm)	0.750 (19.05)	1.000 (25.40)	0.375 (9.53)	200
BMP41, 51, 53	Fig. 42	M-49-427	B-427	Vinyl	BK on WT	12 - 10 Gauge	0.210" (5.33 mm)	1.000 (25.40)	1.000 (25.40)	0.375 (9.53)	200
BMP41, 51, 53	Fig. 42	M-102-427	B-427	Vinyl	BK on WT	10 - 4 Gauge	0.270" (6.86 mm)	0.500 (12.70)	1.250 (31.75)	0.375 (9.53)	200
BMP41, 51, 53	Fig. 42	M-143-427	B-427	Vinyl	BK on WT	10 - 4 Gauge	0.270" (6.86 mm)	1.000 (25.40)	1.250 (31.75)	0.500 (12.70)	200
BMP51, 53	Fig. 42	M-115-427	B-427	Vinyl	BK on WT	10 - 4 Gauge	0.270" (6.86 mm)	1.500 (38.10)	1.250 (31.75)	0.500 (12.70)	200
BMP41, 51, 53	Fig. 42	M-89-427	B-427	Vinyl	BK on WT	10 - 4 Gauge	0.320" (8.13 mm)	0.500 (12.70)	1.500 (38.10)	0.500 (12.70)	360
BMP41, 51, 53	Fig. 42	M-90-427	B-427	Vinyl	BK on WT	10 - 4 Gauge	0.320" (8.13 mm)	0.750 (19.05)	1.500 (38.10)	0.500 (12.70)	200
BMP41, 51, 53	Fig. 42	M-91-427	B-427	Vinyl	BK on WT	10 - 4 Gauge	0.320" (8.13 mm)	1.000 (25.40)	1.500 (38.10)	0.500 (12.70)	200
BMP41, 51, 53	Fig. 42	M-91-427-YL	B-427	Vinyl	BK on YL	10 - 4 Gauge	0.320" (8.13 mm)	1.000 (25.40)	1.500 (38.10)	0.500 (12.70)	200
BMP51, 53	Fig. 42	M-32-427	B-427	Vinyl	BK on WT	10 - 4 Gauge	0.320" (8.13 mm)	1.500 (38.10)	1.500 (38.10)	0.500 (12.70)	180
BMP41, 51, 53	Fig. 42	M-51-427	B-427	Vinyl	BK on WT	3 Gauge - 2/0	0.530" (13.46 mm)	1.000 (25.40)	2.500 (63.50)	0.750 (19.05)	80
BMP41, 51, 53	Fig. 42	M-51-427-YL	B-427	Vinyl	BK on YL	3 Gauge - 2/0	0.530" (13.46 mm)	1.000 (25.40)	2.500 (63.50)	0.750 (19.05)	80
BMP51, 53	Fig. 42	M-116-427	B-427	Vinyl	BK on WT	3 Gauge - 2/0	0.530" (13.46 mm)	1.500 (38.10)	2.500 (63.50)	0.750 (19.05)	80
BMP41, 51, 53	Fig. 42	M-53-427	B-427	Vinyl	BK on WT	3/0 - 400 kcmil	0.850" (21.59 mm)	1.000 (25.40)	4.000 (101.6)	1.000 (25.40)	70
BMP41, 51, 53	Fig. 42	M-53-427-YL	B-427	Vinyl	BK on YL	3/0 - 400 kcmil	0.850" (21.59 mm)	1.000 (25.40)	4.000 (101.6)	1.000 (25.40)	70
BMP51, 53	Fig. 42	M-33-427	B-427	Vinyl	BK on WT	3/0 - 400 kcmil	0.850" (21.59 mm)	1.500 (38.10)	4.000 (101.6)	1.000 (25.40)	70
BMP51, 53	Fig. 42	M-34-427	B-427	Vinyl	BK on WT	500 - 900 kcmil	1.300" (33.02 mm)	1.500 (38.10)	6.000 (152.40)	1.500 (38.10)	40
<b>B-427 – Continuous Self-Laminating Vinyl</b>											
BMP41, 51, 53	Fig. 42a	MC-750-427	B-427	Vinyl	BK on WT	16 - 10 Gauge	0.270" (6.86 mm)	25 ft. (7.62 m)	0.750 (19.05)	0.375 (9.53)	1 roll (cont.)
BMP51, 53	Fig. 42a	MC-1000-427	B-427	Vinyl	BK on WT	12 - 10 Gauge	0.850" (21.59 mm)	25 ft. (7.62 m)	1.000 (25.40)	0.375 (9.53)	1 roll (cont.)
BMP51, 53	Fig. 42a	MC-1250-427	B-427	Vinyl	BK on WT	10 - 4 Gauge	0.530" (13.46 mm)	25 ft. (7.62 m)	1.250 (31.75)	0.500 (12.70)	1 roll (cont.)
BMP51, 53	Fig. 42a	MC-1500-427	B-427	Vinyl	BK on WT	10 - 4 Gauge	0.270" (6.86 mm)	25 ft. (7.62 m)	1.500 (38.10)	0.500 (12.70)	1 roll (cont.)

\* Approximate wire gauge based on AWG for THHN wire.

## PermaSleeve® PS Wire Marking Sleeves (B-342)

Heat-shrink sleeves are the ultimate in marker durability, permanence and aesthetic appearance. Military / Industrial grade 3:1 shrink ratio. Meets several MIL, SAE and ASTM specs. Available as individual die-cut or continuous cut-to-length tubing.

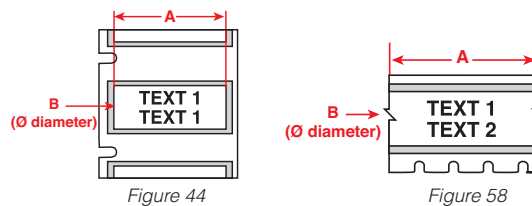

Fits Printer Model	Diagram	Catalog #	B#	Material	Color	Approx. Wire Gauge	For Wire Diameter Inch (mm) Min. Max	Sleeve Width A Inch (mm)	Supplied Diameter B Inch (mm)	Sleeves/Roll
<b>B-342 – PermaSleeve® PS Wire Marking Sleeve</b>										
BMP41, 51, 53	Fig. 21	M-125-075-342	B-342	PermaSleeve	BK on WT	22-16 Gauge	0.046 - 0.110 (1.20 - 2.80 mm)	0.750 (19.1)	0.235 (5.97)	80
BMP51, 53	Fig. 44	M-125-1-342	B-342	PermaSleeve	BK on WT	22-16 Gauge	0.046 - 0.110 (1.20 - 2.80 mm)	1.015 (25.78)	0.235 (5.97)	80
BMP41, 51, 53	Fig. 58	MC-125-342	B-342	PermaSleeve	BK on WT	22-16 Gauge	0.046 - 0.110 (1.20 - 2.80 mm)	7 ft (2.13 m)	0.235 (5.97)	1 roll (cont.)
BMP41, 51, 53	Fig. 58	MC-125-342-YL	B-342	PermaSleeve	BK on YL	22-16 Gauge	0.046 - 0.110 (1.20 - 2.80 mm)	7 ft (2.13 m)	0.235 (5.97)	1 roll (cont.)
BMP41, 51, 53	Fig. 21	M-187-075-342	B-342	PermaSleeve	BK on WT	20-10 Gauge	0.062 - 0.150 (1.60 - 3.80 mm)	0.750 (19.1)	0.335 (8.51)	80
BMP51, 53	Fig. 44	M-187-1-342	B-342	PermaSleeve	BK on WT	20-10 Gauge	0.062 - 0.150 (1.60 - 3.80 mm)	1.015 (25.78)	0.335 (8.51)	80
BMP41, 51, 53	Fig. 58	MC-187-342	B-342	PermaSleeve	BK on WT	20-10 Gauge	0.062 - 0.150 (1.60 - 3.80 mm)	7 ft (2.13 m)	0.335 (8.51)	1 roll (cont.)
BMP41, 51, 53	Fig. 58	MC-187-342-YL	B-342	PermaSleeve	BK on YL	20-10 Gauge	0.062 - 0.150 (1.60 - 3.80 mm)	7 ft (2.13 m)	0.335 (8.51)	1 roll (cont.)
BMP41, 51, 53	Fig. 21	M-250-075-342	B-342	PermaSleeve	BK on WT	16-8 Gauge	0.094 - 0.215 (2.40 - 5.50 mm)	0.750 (19.1)	0.439 (11.15)	80
BMP51, 53	Fig. 44	M-250-1-342	B-342	PermaSleeve	BK on WT	16-8 Gauge	0.094 - 0.215 (2.40 - 5.50 mm)	1.015 (25.78)	0.439 (11.15)	80
BMP41, 51, 53	Fig. 58	MC-250-342	B-342	PermaSleeve	BK on WT	16-8 Gauge	0.094 - 0.215 (2.40 - 5.50 mm)	7 ft (2.13 m)	0.439 (11.15)	1 roll (cont.)
BMP41, 51, 53	Fig. 58	MC-250-342-YL	B-342	PermaSleeve	BK on YL	16-8 Gauge	0.094 - 0.215 (2.40 - 5.50 mm)	7 ft (2.13 m)	0.439 (11.15)	1 roll (cont.)
BMP41, 51, 53	Fig. 21	M-375-075-342	B-342	PermaSleeve	BK on WT	12-4 Gauge	0.125 - 0.320 (3.20 - 8.10 mm)	0.750 (19.1)	0.645 (16.38)	80
BMP51, 53	Fig. 44	M-375-1-342	B-342	PermaSleeve	BK on WT	12-4 Gauge	0.125 - 0.320 (3.20 - 8.10 mm)	1.015 (25.78)	0.645 (16.38)	80
BMP41, 51, 53	Fig. 58	MC-1-375-342	B-342	PermaSleeve	BK on WT	12-4 Gauge	0.125 - 0.320 (3.20 - 8.10 mm)	7 ft (2.13 m)	0.645 (16.38)	1 roll (cont.)

\* Approximate wire gauge based on AWG for THHN wire.



## Vinyl Cloth Adhesive Wire & Cable Wraps (B-498)

Durable vinyl cloth wrap around wire and cable markers made with an aggressive adhesive that adheres securely but allows the marker to be removed cleanly and reapplied if necessary.

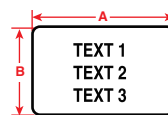

Figure 29



Fits Printer Model	Diagram	Catalog #	B#	Material	Color	Approx. Wire Gauge	Max. Wire Diameter	Label Width A Inch (mm)	Label Height B Inch (mm)	Labels/Roll
<b>B-498 – Vinyl Cloth</b>										
BMP41, 51, 53	Fig. 29	M-7-498	B-498	Vinyl Cloth	BK on WT	22 - 16 Gauge	0.110" (2.80 mm)	0.500 (12.70)	0.500 (12.70)	240
BMP41, 51, 53	Fig. 29	M-11-498	B-498	Vinyl Cloth	BK on WT	16 - 10 Gauge	0.160" (4.00 mm)	0.500 (12.70)	0.750 (19.05)	220
BMP41, 51, 53	Fig. 29	M-163-498	B-498	Vinyl Cloth	BK on WT	12 - 10 Gauge	0.210" (5.00 mm)	0.500 (12.70)	1.000 (25.40)	180
BMP41, 51, 53	Fig. 29	M-48-498	B-498	Vinyl Cloth	BK on WT	12 - 10 Gauge	0.210" (5.00 mm)	1.000 (25.40)	0.750 (19.05)	180
BMP41, 51, 53	Fig. 29	M-49-498	B-498	Vinyl Cloth	BK on WT	12 - 10 Gauge	0.210" (5.00 mm)	1.000 (25.40)	1.000 (25.40)	160
BMP41, 51, 53	Fig. 29	M-91-498	B-498	Vinyl Cloth	BK on WT	10 - 4 Gauge	0.270" (7.00 mm)	1.500 (38.10)	1.000 (25.40)	160

\* Approximate wire gauge based on AWG for THHN wire.

## Wire & Cable Flags and Tags (B-109, B-145, B-425, B-499)

Allow more legible information on data cables and smaller diameter wires. Permits you to handle and view labels without touching the wires.

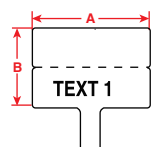

Figure 48

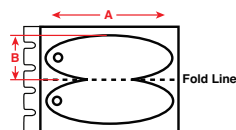

Figure 50

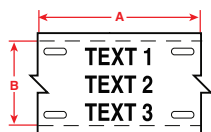

Figure 57

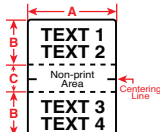
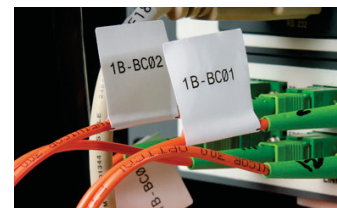

Figure 63



Fits Printer Model	Diagram	Catalog #	B#	Material	Color	Label Width A Inch (mm)	Label Height B Inch (mm)	Label Height C Inch (mm)	Labels/Roll
<b>B-109 – Polypropylene Tag</b>									
BMP51, 53	Fig. 57	M-12-109	B-109	Polypropylene Tag	BK on WT	0.750 (19.05)	3.000 (76.2)	-	80
<b>B-145 – Polypropylene Tag</b>									
BMP51, 53	Fig. 50	M-111-145FR-GY	B-145	Polyethylene Tag	BK on GY	0.758 (19.25)	1.206 (30.63)	-	80
<b>B-425 – Polypropylene Flag</b>									
BMP51, 53	Fig. 48	MFT-01-425	B-425	Polypropylene Flag	BK on WT	0.788 (20.01)	1.18 (29.97)	-	200
<b>B-499 - Nylon Cloth</b>									
BMP41, 51, 53	Fig. 63	M-141-499	B-499	Nylon Cloth	BK on WT	1.000 (25.40)	1.000 (25.40)	0.250 (6.35)	90
BMP51, 53	Fig. 63	M-152-499	B-499	Nylon Cloth	BK on WT	1.500 (38.10)	0.500 (12.70)	0.250 (6.35)	160



### Did You Know? Print with the Mobile App

You can create these labels and more from your Android™ phone!  
With the Brady Mobile App, you can easily create labels on your Android device and print them wirelessly to your BMP<sup>®</sup>51 Label Maker.



Scan to download the app!



# BMP®51 and BMP®53 Materials

BradyID.com/bmp51

## Self-Laminating Vinyl Labels for Datacomm (B-427)

Features a clear, non-printable area that wraps around the cable and overlaminates the printed text. Offers superior resistance to handling, abrasion, dirt, oils, solvents, and water.

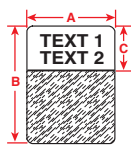

Figure 42

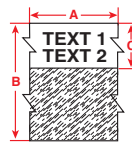

Figure 42a (continuous)



Fits Printer Model	Diagram	Catalog #	B#	Material	Color	Sized to Fit	Label Width A Inch (mm)	Label Height B Inch (mm)	Print-On Height C Inch (mm)	Labels/Roll
<b>B-427 – Self-Laminating Vinyl</b>										
BMP41, 51, 53	Fig. 42	M-49-427	B-427	Vinyl	BK on WT	2 pair Fiber/Coaxial, Single/Multi-Mode	1.000 (25.40)	1.000 (25.40)	0.375 (9.53)	200
BMP41, 51, 53	Fig. 42	M-102-427	B-427	Vinyl	BK on WT	CAT-6, 4 pair UTP Copper	0.500 (12.70)	1.250 (31.75)	0.375 (9.53)	200
BMP51, 53	Fig. 42	M-115-427	B-427	Vinyl	BK on WT	CAT-6, 4 pair UTP Copper	1.500 (38.10)	1.250 (31.75)	0.500 (12.70)	200
BMP41, 51, 53	Fig. 42	M-143-427	B-427	Vinyl	BK on WT	CAT-6, 4 pair UTP Copper, Fiber, Coaxial	1.000 (25.40)	1.250 (31.75)	0.500 (12.70)	200
BMP41, 51, 53	Fig. 42	M-89-427	B-427	Vinyl	BK on WT	CAT-6, 4 pair UTP Copper	0.500 (12.70)	1.500 (38.10)	0.500 (12.70)	360
BMP41, 51, 53	Fig. 42	M-90-427	B-427	Vinyl	BK on WT	CAT-6, 4 pair UTP Copper	0.750 (19.05)	1.500 (38.10)	0.500 (12.70)	200
BMP41, 51, 53	Fig. 42	M-91-427	B-427	Vinyl	BK on WT	CAT-6, 4 pair UTP Copper, Fiber, Coaxial	1.000 (25.40)	1.500 (38.10)	0.500 (12.70)	200
BMP41, 51, 53	Fig. 42	M-91-427-YL	B-427	Vinyl	BK on YL	CAT-6, 4 pair UTP Copper, Fiber, Coaxial	1.000 (25.40)	1.500 (38.10)	0.500 (12.70)	200
BMP51, 53	Fig. 42	M-32-427	B-427	Vinyl	BK on WT	CAT-6, 4 pair UTP Copper, Fiber, Coaxial	1.500 (38.10)	1.500 (38.10)	0.500 (12.70)	180
BMP41, 51, 53	Fig. 42	M-51-427	B-427	Vinyl	BK on WT	25 pair Copper, 4-12 pair Fiber, Coaxial	1.000 (25.40)	2.500 (63.50)	0.750 (19.05)	80
BMP41, 51, 53	Fig. 42	M-51-427-YL	B-427	Vinyl	BK on YL	25 pair Copper, 4-12 pair Fiber, Coaxial	1.000 (25.40)	2.500 (63.50)	0.750 (19.05)	80
BMP51, 53	Fig. 42	M-116-427	B-427	Vinyl	BK on WT	25 pair Copper, 4-12 pair Fiber, Coaxial	1.500 (38.10)	2.500 (63.50)	0.750 (19.05)	80
BMP41, 51, 53	Fig. 42	M-53-427	B-427	Vinyl	BK on WT	50 pair Copper, 24 pair Fiber, Backbone	1.000 (25.40)	4.000 (101.60)	1.000 (25.40)	70
BMP41, 51, 53	Fig. 42	M-53-427-YL	B-427	Vinyl	BK on YL	50 pair Copper, 24 pair Fiber, Backbone	1.000 (25.40)	4.000 (101.60)	1.000 (25.40)	70
BMP51, 53	Fig. 42	M-33-427	B-427	Vinyl	BK on WT	50 pair Copper, 24 pair Fiber, Backbone	1.500 (38.10)	4.000 (101.60)	1.000 (25.40)	70
BMP51, 53	Fig. 42	M-34-427	B-427	Vinyl	BK on WT	100 pair Copper, 36 pair Fiber, Backbone	1.500 (38.10)	6.000 (152.40)	1.500 (38.10)	40
<b>B-427 – Continuous Self-Laminating Vinyl</b>										
BMP51, 53	Fig. 42a	MC-1000-427	B-427	Vinyl	BK on WT	CAT-6, 4 pair UTP Copper	25 ft. (7.62 m)	1.000 (25.40)	0.375 (9.53)	1 roll (cont.)
BMP51, 53	Fig. 42a	MC-1500-427	B-427	Vinyl	BK on WT	CAT-6, 4 pair UTP Copper	25 ft. (7.62 m)	1.500 (38.10)	0.500 (12.70)	1 roll (cont.)

## Faceplate & Outlet ID (B-412, B-422, B-483)

Label your ports, jacks, and outlets with a variety of adhesive labels or slide-in strips.

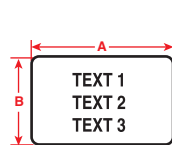

Figure 29



Figure 33



Fits Printer Model	Diagram	Catalog #	B#	Material	Color	Material Notes	Label Width A Inch (mm)	Label Height B Inch (mm)	Labels/Roll
<b>B-412 – Polypropylene Tag</b>									
BMP41, 51, 53	Fig. 33	MC-475-412	B-412	Polypropylene Tag	BK on WT	Non-Adhesive Slide-in Strips	0.475 (12.07)	20 ft (6.09 m)	1 roll (cont.)
<b>B-422 – Gloss Polyester</b>									
BMP41, 51, 53	Fig. 33	MC-375-422	B-422	Gloss Polyester	BK on WT	Adhesive Strips	0.375 (9.53)	25 ft (7.62 m)	1 roll (cont.)
BMP41, 51, 53	Fig. 33	MC-475-422	B-422	Gloss Polyester	BK on WT	Adhesive Strips	0.475 (12.07)	25 ft (7.62 m)	1 roll (cont.)
BMP41, 51, 53	Fig. 29	M-7-422	B-422	Gloss Polyester	BK on WT	Individual Adhesive Labels	0.500 (12.70)	0.500 (12.70)	280
BMP41, 51, 53	Fig. 29	M-89-422	B-422	Gloss Polyester	BK on WT	Individual Adhesive Labels	1.500 (38.10)	0.500 (12.70)	360
BMP41, 51, 53	Fig. 29	M-47-422	B-422	Gloss Polyester	BK on WT	Individual Adhesive Labels	1.000 (25.40)	0.500 (12.70)	360
BMP41, 51, 53	Fig. 29	M-90-422	B-422	Gloss Polyester	BK on WT	Individual Adhesive Labels	1.500 (38.10)	0.750 (19.05)	200
<b>B-483 – Ultra Aggressive Polyester</b>									
BMP41, 51, 53	Fig. 29	M-61-483	B-483	Polyester	BK on WT	Individual Adhesive Labels	2.000 (50.80)	0.500 (12.70)	80

## Punch Block & Patch Panel ID (B-412, B-422)

Using BMP®51 printer's built-in templates, LabelMark™ 6 Software or the Brady Mobile App, you can easily create serialized punch block labels and patch panel strips with or without grid lines to fit your equipment.

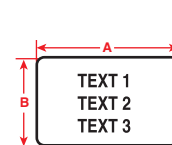

Figure 29

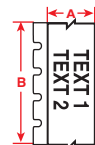
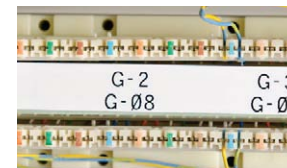

Figure 33



Fits Printer Model	Diagram	Catalog #	B#	Material	Color	Material Notes	Label Width A Inch (mm)	Label Height B Inch (mm)	Labels/Roll
<b>B-412 – Polypropylene Tag</b>									
BMP41, 51, 53	Fig. 33	MC-375-412	B-412	Polypropylene Tag	BK on WT	Non-Adhesive Slide-in Strips	0.375 (9.53)	20 ft (6.09 m)	1 roll (cont.)
BMP41, 51, 53	Fig. 33	MC-475-412	B-412	Polypropylene Tag	BK on WT	Non-Adhesive Slide-in Strips	0.475 (12.07)	20 ft (6.09 m)	1 roll (cont.)
BMP41, 51, 53	Fig. 33	MC-625-412	B-412	Polypropylene Tag	BK on WT	Non-Adhesive Slide-in Strips	0.675 (12.07)	20 ft (6.09 m)	1 roll (cont.)
<b>B-422 - Gloss Polyester</b>									
BMP41, 51, 53	Fig. 33	MC-375-422	B-422	Gloss Polyester	BK on WT	Adhesive Strips	0.375 (9.53)	25 ft (7.62 m)	1 roll (cont.)
BMP41, 51, 53	Fig. 33	MC-475-422	B-422	Gloss Polyester	BK on WT	Adhesive Strips	0.475 (12.07)	25 ft (7.62 m)	1 roll (cont.)
BMP41, 51, 53	Fig. 33	MC-625-422	B-422	Gloss Polyester	BK on WT	Adhesive Strips	0.675 (12.07)	25 ft (7.62 m)	1 roll (cont.)
BMP41, 51, 53	Fig. 29	M-7-422	B-422	Gloss Polyester	BK on WT	Individual Adhesive Port Labels	0.500 (12.70)	0.500 (12.70)	280

## Data Center Equipment ID (B-422, B-483, B-595)

Durable materials with permanent adhesive suited to adhere to rough, highly textured or powder coated surfaces. Available in a variety of sizes and colors for marking racks, bays, frames, slots, and other voice/data hardware.

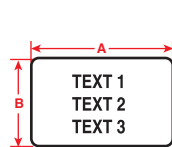

Figure 29

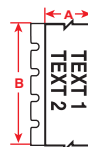

Figure 33



Fits Printer Model	Diagram	Catalog #	B#	Material	Color	Material Notes	Label Width A Inch (mm)	Label Height B Inch (mm)	Labels/Roll
<b>B-422 – Gloss Polyester</b>									
BMP41, 51, 53	Fig. 29	M-7-422	B-422	Gloss Polyester	BK on WT	For smooth or textured surfaces	0.500 (12.70)	0.500 (12.70)	280
BMP41, 51, 53	Fig. 33	MC-500-422	B-422	Gloss Polyester	BK on WT	For smooth or textured surfaces	0.500 (12.7)	25 ft (7.6 m)	1 roll (cont.)
BMP41, 51, 53	Fig. 29	M-47-422	B-422	Gloss Polyester	BK on WT	For smooth or textured surfaces	1.000 (25.40)	0.500 (12.70)	360
BMP41, 51, 53	Fig. 29	M-49-422	B-422	Gloss Polyester	BK on WT	For smooth or textured surfaces	1.000 (25.40)	1.000 (25.40)	200
BMP41, 51, 53	Fig. 29	MC1-1000-422	B-422	Gloss Polyester	BK on WT	For smooth or textured surfaces	1.000 (25.40)	25 ft (7.62 m)	1 roll (cont.)
BMP41, 51, 53	Fig. 29	M-89-422	B-422	Gloss Polyester	BK on WT	For smooth or textured surfaces	1.500 (38.10)	0.500 (12.70)	360
BMP41, 51, 53	Fig. 29	M-90-422	B-422	Gloss Polyester	BK on WT	For smooth or textured surfaces	1.500 (38.10)	0.750 (19.05)	200
<b>B-483 – Ultra Aggressive Polyester</b>									
BMP41, 51, 53	Fig. 29	M-47-483	B-483	Polyester	BK on WT	For smooth or textured surfaces	1.000 (25.40)	0.500 (12.70)	360
BMP41, 51, 53	Fig. 29	M-61-483	B-483	Polyester	BK on WT	For smooth or textured surfaces	2.000 (50.80)	0.500 (12.70)	80
BMP41, 51, 53	Fig. 29	M-60-483	B-483	Polyester	BK on WT	For smooth or textured surfaces	2.000 (50.80)	1.000 (25.40)	80
<b>B-595 – Indoor / Outdoor Vinyl Tape*</b>									
BMP41, 51, 53	Fig. 33	MC-500-595-WT-BK	B-595	Vinyl	BK on WT	In/Outdoor Vinyl for dark surfaces	0.500 (12.70)	20 ft (6.09 m)	1 roll (cont.)
BMP41, 51, 53	Fig. 33	MC-750-595-WT-BK	B-595	Vinyl	BK on WT	In/Outdoor Vinyl for dark surfaces	0.750 (19.05)	20 ft (6.09 m)	1 roll (cont.)
BMP41, 51, 53	Fig. 33	MC1-1000-595-WT-BK	B-595	Vinyl	BK on WT	In/Outdoor Vinyl for dark surfaces	1.000 (25.40)	20 ft (6.09 m)	1 roll (cont.)
BMP41, 51, 53	Fig. 33	MC-1500-595-WT-BK	B-595	Vinyl	BK on WT	In/Outdoor Vinyl for dark surfaces	1.500 (38.10)	20 ft (6.09 m)	1 roll (cont.)
BMP41, 51, 53	Fig. 33	MC-500-595-CL-WT	B-595	Vinyl	WT on CL	In/Outdoor Vinyl for dark surfaces	0.500 (12.70)	20 ft (6.09 m)	1 roll (cont.)
BMP41, 51, 53	Fig. 33	MC-750-595-CL-WT	B-595	Vinyl	WT on CL	In/Outdoor Vinyl for dark surfaces	0.750 (19.05)	20 ft (6.09 m)	1 roll (cont.)
BMP41, 51, 53	Fig. 33	MC1-1000-595-CL-WT	B-595	Vinyl	WT on CL	In/Outdoor Vinyl for dark surfaces	1.000 (25.40)	20 ft (6.09 m)	1 roll (cont.)
BMP41, 51, 53	Fig. 33	MC-1500-595-CL-WT	B-595	Vinyl	WT on CL	In/Outdoor Vinyl for dark surfaces	1.500 (38.10)	20 ft (6.09 m)	1 roll (cont.)
BMP41, 51, 53	Fig. 33	MC-500-595-YL-BK	B-595	Vinyl	BK on YL	In/Outdoor Vinyl for dark surfaces	0.500 (12.70)	20 ft (6.09 m)	1 roll (cont.)
BMP41, 51, 53	Fig. 33	MC-750-595-YL-BK	B-595	Vinyl	BK on YL	In/Outdoor Vinyl for dark surfaces	0.750 (19.05)	20 ft (6.09 m)	1 roll (cont.)
BMP41, 51, 53	Fig. 33	MC1-1000-595-YL-BK	B-595	Vinyl	BK on YL	In/Outdoor Vinyl for dark surfaces	1.000 (25.40)	20 ft (6.09 m)	1 roll (cont.)
BMP41, 51, 53	Fig. 33	MC-1500-595-YL-BK	B-595	Vinyl	BK on YL	In/Outdoor Vinyl for dark surfaces	1.500 (38.10)	20 ft (6.09 m)	1 roll (cont.)

\* For additional vinyl label colors, refer to the B-595 Indoor/Outdoor Grade Facility and Safety Labels on page 302.

## Labels for Bin, Storage, Lean 5S and General Industrial ID (B-483, B-499, B-595)

Choose from several materials with aggressive adhesives for use in commercial/industrial applications, including low surface energy and textured surfaces.

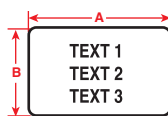

Figure 29



Figure 33



Fits Printer Model	Diagram	Catalog #	B#	Material	Color	Label Width A Inch (mm)	Label Height B Inch (mm)	Labels/Roll
<b>B-483 – Ultra Aggressive Polyester</b>								
BMP41, 51, 53	Fig. 29	M-47-483	B-483	Polyester	BK on WT	1.000 (25.40)	0.500 (12.70)	360
BMP41, 51, 53	Fig. 29	M-60-483	B-483	Polyester	BK on WT	2.000 (50.80)	1.000 (25.40)	80
BMP41, 51, 53	Fig. 29	M-61-483	B-483	Polyester	BK on WT	2.000 (50.80)	0.500 (12.70)	80
<b>B-499 – Nylon Cloth</b>								
BMP41, 51, 53	Fig. 29	M-11-499	B-499	Nylon Cloth	BK on WT	0.750 (19.05)	0.500 (12.70)	220
BMP41, 51, 53	Fig. 29	M-84-499	B-499	Nylon Cloth	BK on WT	0.900 (22.86)	0.500 (12.70)	200
BMP51, 53	Fig. 29	M-132-499	B-499	Nylon Cloth	BK on WT	1.500 (38.10)	1.250 (31.75)	160
BMP41, 51, 53	Fig. 29	M-128-499	B-499	Nylon Cloth	BK on WT	1.900 (48.26)	1.000 (25.40)	100
<b>B-595 – Indoor / Outdoor Vinyl Tape*</b>								
BMP41, 51, 53	Fig. 33	MC-750-595-WT-BK	B-595	Vinyl	BK on WT	0.750 (19.10)	25 ft (7.62 m)	1 roll (cont.)
BMP41, 51, 53	Fig. 33	MC1-1000-595-WT-BK	B-595	Vinyl	BK on WT	1.000 (25.40)	25 ft (7.62 m)	1 roll (cont.)
BMP51, 53	Fig. 33	MC-1500-595-WT-BK	B-595	Vinyl	BK on WT	1.500 (38.10)	25 ft (7.62 m)	1 roll (cont.)
BMP41, 51, 53	Fig. 33	MC-750-595-YL-BK	B-595	Vinyl	BK on YL	0.750 (19.10)	25 ft (7.62 m)	1 roll (cont.)
BMP41, 51, 53	Fig. 33	MC1-1000-595-YL-BK	B-595	Vinyl	BK on YL	1.000 (25.40)	25 ft (7.62 m)	1 roll (cont.)
BMP51, 53	Fig. 33	MC-1500-595-YL-BK	B-595	Vinyl	BK on YL	1.500 (38.10)	25 ft (7.62 m)	1 roll (cont.)

\* For additional vinyl label colors, refer to the B-595 Indoor/Outdoor Grade Facility and Safety Labels on page 302.



# BMP®51 and BMP®53 Materials

BradyID.com/bmp51

## Polyester Labels for Rating Plates and General ID (B-422, B-483, B-428)

Standard and metallized labels ideal for labeling rating plate, products and general industrial applications.

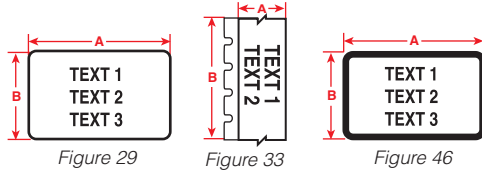

Fits Printer Model	Diagram	Catalog #	B#	Material	Color	Label Width A Inch (mm)	Label Height B Inch (mm)	Labels/Roll
<b>B-422 – Gloss Polyester</b>								
BMP41, 51, 53	Fig. 33	MC-375-422	B-422	Gloss Polyester	BK on WT	0.375 (9.53)	25 ft. (7.60 m)	1 roll (cont.)
BMP41, 51, 53	Fig. 33	MC-475-422	B-422	Gloss Polyester	BK on WT	0.475 (12.07)	25 ft. (7.60 m)	1 roll (cont.)
BMP41, 51, 53	Fig. 29	M-7-422	B-422	Gloss Polyester	BK on WT	0.500 (12.70)	0.500 (12.70)	280
BMP41, 51, 53	Fig. 33	MC-500-422	B-422	Gloss Polyester	BK on WT	0.500 (12.70)	25 ft. (7.60 m)	1 roll (cont.)
BMP41, 51, 53	Fig. 29	M-47-422	B-422	Gloss Polyester	BK on WT	1.000 (25.40)	0.500 (12.70)	360
BMP41, 51, 53	Fig. 29	M-49-422	B-422	Gloss Polyester	BK on WT	1.000 (25.40)	1.000 (25.40)	200
BMP41, 51, 53	Fig. 33	MC1-1000-422	B-422	Gloss Polyester	BK on WT	1.000 (25.40)	25 ft. (7.60 m)	1 roll (cont.)
BMP41, 51, 53	Fig. 29	M-90-422	B-422	Gloss Polyester	BK on WT	1.500 (38.10)	0.750 (19.05)	200
BMP41, 51, 53	Fig. 29	M-89-422	B-422	Gloss Polyester	BK on WT	1.500 (38.10)	0.500 (12.70)	360
<b>B-483 – Ultra Aggressive Polyester</b>								
BMP41, 51, 53	Fig. 29	M-47-483	B-483	Polyester	BK on WT	1.000 (25.40)	0.500 (12.70)	360
BMP41, 51, 53	Fig. 29	M-60-483	B-483	Polyester	BK on WT	2.000 (50.80)	1.000 (25.40)	80
BMP41, 51, 53	Fig. 29	M-61-483	B-483	Polyester	BK on WT	2.000 (50.80)	0.500 (12.70)	80
<b>B-428 – Metallized Polyester</b>								
BMP41, 51, 53	Fig. 46	M-92-428-BB	B-428	Metallized Polyester	BK on SV	1.130 (28.70)	0.500 (12.70)	360
BMP51, 53	Fig. 29	M-29-428	B-428	Metallized Polyester	BK on SV	1.500 (38.10)	0.500 (12.70)	360
BMP51, 53	Fig. 29	M-30-428	B-428	Metallized Polyester	BK on SV	1.500 (38.10)	0.750 (19.10)	260
BMP41, 51, 53	Fig. 29	M-60-428	B-428	Metallized Polyester	BK on SV	2.000 (50.80)	1.000 (25.40)	80

## Tamper-Indicating Vinyl Material (B-351)

Destructible vinyl material prohibits one piece removal of label to indicate if the label has been tampered with.

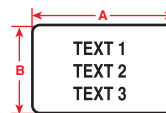

Figure 29



Fits Printer Model	Diagram	Catalog #	B#	Material	Color	Label Width A Inch (mm)	Label Height B Inch (mm)	Labels/Roll
<b>B-351 – Tamper Evident Vinyl</b>								
BMP51, 53	Fig. 29	M-17-351	B-351	Vinyl	BK on WT	1.000 (25.40)	0.500 (12.70)	360
BMP51, 53	Fig. 29	M-20-351	B-351	Vinyl	BK on WT	1.000 (25.40)	2.000 (50.80)	160

## Get the job done for less with a Brady Starter Kit.

Save 10% versus purchasing each part separately!



\* BMP51 kit shown.

### Voice / Data Communications Starter Kit

Everything you need to get started with your voice/data labeling. Kit includes:

- Hard case, USB cable and AC power supply
- Self-laminating cable markers (M-21-427)
- Port, faceplate and general ID labels (M-30-422)
- Non-adhesive slide-in strips for punch blocks (MC-475-412)
- Rack and panel labels (MC-1000-595-YL-BK)
- 1.5" White label roll for general ID (MC-1500-595-WT-BK)

Catalog #	Description
BMP51-KIT-VD	Kit with BMP51 Label Printer and Li-Ion Battery
BMP53-KIT-VD	Kit with BMP53 Label Printer and LabelMark™ 5 Software



\* BMP53 kit shown.

### Electrical Starter Kit

This kit includes a variety of wire and cable marking materials, as well as continuous tape for panel identification. Kit includes:

- Hard case, USB cable and AC power supply
- Self-laminating wire markers (M-103-427)
- Wrap around wire markers (M-18-498)
- PermaSleeve® PS heat shrink wire markers (M-187-1-342)
- Panel identification labels (MC-1500-595-OR-BK)
- 1.5" White label roll for general ID (MC-1500-595-WT-BK)

Catalog #	Description
BMP51-KIT-EL	Kit with BMP51 Label Printer and Li-Ion Battery
BMP53-KIT-EL	Kit with BMP53 Label Printer and LabelMark™ 5 Software



\* BMP51 kit shown.

### Facility Identification Starter Kit

Kit includes a variety of our durable indoor/outdoor vinyl tapes. Kit includes:

- Hard case, USB cable and AC power supply
- 1.5" Yellow label roll with black ribbon (MC-1500-595-YL-BK)
- 1.5" White label roll with red ribbon (MC-1500-595-WT-RD)
- 1.5" Green label roll with white ribbon (MC-1500-595-GN-WT)
- 1.5" White label roll with black ribbon (MC-1500-595-WT-BK)
- 2" x 1" labels for low surface energy labeling (M-20-483)

Catalog #	Description
BMP51-KIT-GI	Kit with BMP51 Label Printer and Li-Ion Battery
BMP53-KIT-GI	Kit with BMP53 Label Printer and LabelMark™ 5 Software



\* BMP53 kit shown.

### Lab Identification Starter Kit

Accurately identify and track samples in your lab with this lab ID starter kit. Kit includes:

- Hard case, USB cable and AC power supply
- Vial & tube labels (M-156-492)
- Microplate labels (M-81-488)
- Top & side label set for vials & tubes (M-120-492)
- Removable diecut labels for bottles, beakers, etc. (M-103-498)
- 1.5" White label roll for general ID (MC-1500-595-WT-BK)

Catalog #	Description
BMP51-KIT-LS	Kit with BMP51 Label Printer and Li-Ion Battery
BMP53-KIT-LS	Kit with BMP53 Label Printer and LabelMark™ 5 Software



# TLS2200® Labeling System

BradyID.com/tls2200

Portable Printers



## TLS2200® Label Printer

A rugged, portable, and easy-to-use labeling solution with crisp, thermal-transfer quality printing and a variety of durable materials. Create custom labels for the most demanding applications including product bar code ID, electrical and datacomm marking, laboratory ID, security ID, and more.

## TLS PC Link™ Label Printer

A small footprint and lightweight, rugged design makes the TLS PC Link printer a nice fit for a variety of medium volume (approximately 500 labels per print run) applications. It connects to a PC for use with the included LabelMark™ software or other Windows based programs.

The same basic design as the TLS 2200® allows you to utilize the same consumables (including bulk rolls) in both the TLS 2200 and the TLS PC Link.



**TLS2200®**  
THERMAL LABELING SYSTEM



### Online Video!

Visit [BradyID.com/tls2200](http://BradyID.com/tls2200) for more information or to view an online printer demo video.

### Your Complete Printing Solution:

TLS Label Rolls.....page 311  
TLS Print Ribbons.....page 323



### TLS2200® / TLS PC Link Printer Specifications

<b>Max Labels Per Day</b>	Average 750 labels/day
<b>Print Resolution</b>	203 dpi
<b>Print Technology</b>	Thermal Transfer
<b>Print Speed</b>	12 mm/sec (0.47 in/sec)
<b>Tape Widths (inches)</b>	Various sizes from 0.25" to 2.00"
<b>Tape Widths (mm)</b>	Various sizes from 6.4 to 50.8 mm
<b>Max Label Width</b>	2.00" (50.8mm)
<b>Max Print Width</b>	1.810" (46.0mm)
<b>Memory</b>	21,000 characters / None
<b>Materials Supported</b>	PTL-, BPTL- Series 500+ Stock Parts
<b>Continuous vs Die Cut Labels</b>	Continuous and die cut labels
<b>Connectivity Options</b>	Serial
<b>PC Connectivity</b>	Yes
<b>Software Compatibility</b>	LabelMark® / CodeSoft™ Software
<b>Data Transfer from PC to printer</b>	No
<b>Wireless Connectivity</b>	No
<b>Stand Alone Printing</b>	Yes
<b>Color Capability</b>	Single Color Printing
<b>Keyboard</b>	ABC / None
<b>Backlit Screen</b>	No
<b>Text Sizes</b>	1 to 19 (4 to 72 point)
<b>Multi-Line Print</b>	Yes
<b>Print Rotation</b>	Yes
<b>Serialization</b>	Yes
<b>Barcode</b>	128, IFT 25, Codabar
<b>Symbols</b>	44 on keypad / LabelMark Supported Symbols
<b>Portability</b>	Yes / No
<b>Label Types or Application Functions</b>	Banner Portrait, Banner Landscape, Wire, Patch Panel, Terminal Block, Desi Strip, Fixed Length
<b>Applications</b>	Circuit Board Labeling, Data Communications Labeling, Facility, Safety & Maintenance Identification, General & Industrial Labeling, Laboratory Identification, Panel Identification, Security Identification, Wire & Cable Marking
<b>Power Supply</b>	Rechargeable Battery, AC Power (optional)
<b>Weight</b>	2.75 lbs (1.25kg) / 2.5 lbs (1.13kg)
<b>Warranty</b>	1 year

### TLS2200® Printer & Accessories

Catalog #	Description
TLS2200	TLS2200 Thermal Label Printer*
TLS2200-AC	TLS2200 AC Power Supply
TLSHM-QUICKCH	TLS2200 Battery Quick Charger

\*Includes hard case, battery pack, battery charger, test labels (PTL-19-423), R6210 ribbon, cleaning strip, communications cable, manual, Quick Start Guide and 1 year Limited Warranty.

### TLS PC Link® Printer & Accessories

Catalog #	Description
TLSPC	TLS PC Link Thermal Labeling System*
TLSPC-AC	Replacement power supply/battery charger
TLSPC-BP	Rechargeable battery pack
TLSPC-CABLE	Communications cable
PCK-5	Cleaning Kit (5 cleaning cards)

\*Includes LabelMark™ labeling software, rechargeable battery pack, power supply/battery charger, R6210 ribbon, sample labels (PTL-19-423), Quick Start Guide, manuals, communications cable, Windows® drivers and 1 year Limited Warranty.

## Create Custom Labels In Seconds



Wire & Cable Labeling



Voice & Data Communications



Industrial Barcode Labels



Asset ID



Circuit Board Labels

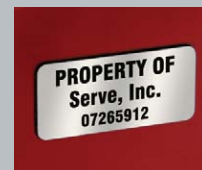

General ID  
...and many more!

## Vinyl Material for Industrial Labeling (B-439)

Colored outdoor grade vinyl material for thermal transfer printing. Ideal for general labeling of equipment, panels, shelves, bins and tools in industrial and production areas.

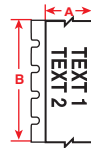
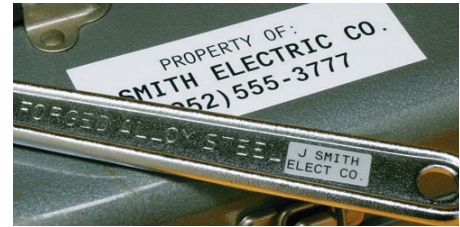

Figure 33



Fits Printer Models	Diagram	Part Number	B-#	Material	Color	Label Width A Inch (mm)	Label Height B Inch (mm)	Labels Per Row	Labels Per Roll	Rec. Ribbon
TLS, BMP71*	Fig. 33	PTL-8-439	B-439	Vinyl	White	0.500 (12.7)	50 ft. (15.2 m)	1	1 Roll Cont.	R6010
TLS, BMP71*	Fig. 33	PTL-42-439	B-439	Vinyl	White	1.000 (25.4)	50 ft. (15.2 m)	1	1 Roll Cont.	R6010
TLS, BMP71*	Fig. 33	PTL-43-439	B-439	Vinyl	White	1.900 (48.3)	50 ft. (15.2 m)	1	1 Roll Cont.	R6010
TLS, BMP71*	Fig. 33	PTL-8-439-YL	B-439	Vinyl	Yellow	0.500 (12.7)	50 ft. (15.2 m)	1	1 Roll Cont.	R6010
TLS, BMP71*	Fig. 33	PTL-42-439-YL	B-439	Vinyl	Yellow	1.000 (25.4)	50 ft. (15.2 m)	1	1 Roll Cont.	R6010
TLS, BMP71*	Fig. 33	PTL-43-439-YL	B-439	Vinyl	Yellow	1.900 (48.3)	50 ft. (15.2 m)	1	1 Roll Cont.	R6010
TLS, BMP71*	Fig. 33	PTL-8-439-BK	B-439	Vinyl	Black	0.500 (12.7)	50 ft. (15.2 m)	1	1 Roll Cont.	R4410-WT
TLS, BMP71*	Fig. 33	PTL-42-439-BK	B-439	Vinyl	Black	1.000 (25.4)	50 ft. (15.2 m)	1	1 Roll Cont.	R4410-WT
TLS, BMP71*	Fig. 33	PTL-43-439-BK	B-439	Vinyl	Black	1.900 (48.3)	50 ft. (15.2 m)	1	1 Roll Cont.	R4410-WT
TLS, BMP71*	Fig. 33	PTL-8-439-BL	B-439	Vinyl	Blue	0.500 (12.7)	50 ft. (15.2 m)	1	1 Roll Cont.	R4410-WT
TLS, BMP71*	Fig. 33	PTL-42-439-BL	B-439	Vinyl	Blue	1.000 (25.4)	50 ft. (15.2 m)	1	1 Roll Cont.	R4410-WT
TLS, BMP71*	Fig. 33	PTL-43-439-BL	B-439	Vinyl	Blue	1.900 (48.3)	50 ft. (15.2 m)	1	1 Roll Cont.	R4410-WT
TLS, BMP71*	Fig. 33	PTL-8-439-GR	B-439	Vinyl	Green	0.500 (12.7)	50 ft. (15.2 m)	1	1 Roll Cont.	R6010
TLS, BMP71*	Fig. 33	PTL-42-439-GR	B-439	Vinyl	Green	1.000 (25.4)	50 ft. (15.2 m)	1	1 Roll Cont.	R6010
TLS, BMP71*	Fig. 33	PTL-43-439-GR	B-439	Vinyl	Green	1.900 (48.3)	50 ft. (15.2 m)	1	1 Roll Cont.	R6010
TLS, BMP71*	Fig. 33	PTL-8-439-OR	B-439	Vinyl	Orange	0.500 (12.7)	50 ft. (15.2 m)	1	1 Roll Cont.	R6010
TLS, BMP71*	Fig. 33	PTL-42-439-OR	B-439	Vinyl	Orange	1.000 (25.4)	50 ft. (15.2 m)	1	1 Roll Cont.	R6010
TLS, BMP71*	Fig. 33	PTL-43-439-OR	B-439	Vinyl	Orange	1.900 (48.3)	50 ft. (15.2 m)	1	1 Roll Cont.	R6010
TLS, BMP71*	Fig. 33	PTL-8-439-RD	B-439	Vinyl	Red	0.500 (12.7)	50 ft. (15.2 m)	1	1 Roll Cont.	R6010
TLS, BMP71*	Fig. 33	PTL-42-439-RD	B-439	Vinyl	Red	1.000 (25.4)	50 ft. (15.2 m)	1	1 Roll Cont.	R6010
TLS, BMP71*	Fig. 33	PTL-43-439-RD	B-439	Vinyl	Red	1.900 (48.3)	50 ft. (15.2 m)	1	1 Roll Cont.	R6010

## Repositionable Vinyl Cloth Labels for General ID (B-498)

Repositionable vinyl cloth material for wire, cable, and component marking as well as general ID. Adhesive offers excellent holding power, while easily being repositioned and removed.

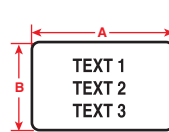

Figure 29

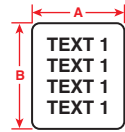

Figure 31

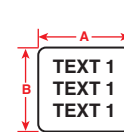

Figure 37



Fits Printer Models	Diagram	Part Number	B-#	Material	Color	Approx. Wire Gauge	Label Width A Inch (mm)	Label Height B Inch (mm)	Labels Per Row	Labels Per Roll	Rec. Ribbon
TLS, BMP71*	Fig. 37	PTL-7-499	B-499	Nylon	White	22 to 16	0.500 (12.7)	0.500 (12.7)	1	500	R4310
TLS, BMP71*	Fig. 31	BM71-11-499	B-499	Nylon	White	16 to 10	0.500 (12.7)	0.750 (19.1)	1	5000	R4310
TLS, BMP71*	Fig. 31	PTL-11-499	B-499	Nylon	White	16 to 10	0.500 (12.7)	0.750 (19.1)	1	500	R4310
TLS, BMP71*	Fig. 31	PTL-16-499	B-499	Nylon	White	12 to 10	0.375 (9.5)	1.000 (25.4)	1	500	R4310
TLS, BMP71*	Fig. 31	PTL-18-499	B-499	Nylon	White	12 to 10	0.750 (19.1)	1.000 (25.4)	1	250	R4310
TLS, BMP71*	Fig. 37	PTL-19-499	B-499	Nylon	White	12 to 10	1.000 (25.4)	1.000 (25.4)	1	250	R4310
TLS, BMP71*	Fig. 31	PTL-28-499	B-499	Nylon	White	10 to 4	0.250 (6.4)	1.500 (38.1)	1	750	R4310
TLS, BMP71*	Fig. 31	PTL-29-498	B-499	Nylon	White	10 to 4	0.500 (12.7)	1.500 (38.1)	1	500	R6210
TLS, BMP71*	Fig. 31	PTL-29-499	B-499	Nylon	White	10 to 4	0.500 (12.7)	1.500 (38.1)	1	500	R4310
TLS, BMP71*	Fig. 31	PTL-30-499	B-499	Nylon	White	10 to 4	0.750 (19.1)	1.500 (38.1)	1	250	R4310
TLS, BMP71*	Fig. 31	PTL-31-499	B-499	Nylon	White	10 to 4	1.000 (25.4)	1.500 (38.1)	1	250	R4310
TLS, BMP71*	Fig. 31	PTL-21-499	B-499	Nylon	White	Cables	1.000 (25.4)	2.500 (63.5)	1	100	R4310
TLS, BMP71*	Fig. 31	PTL-23-499	B-499	Nylon	White	Cables	1.000 (25.4)	4.000 (101.6)	1	100	R4310
TLS, BMP71*	Fig. 29	PTL-84-499	B-499	Nylon	White	-	0.900 (22.9)	0.500 (12.7)	1	500	R4310
TLS, BMP71*	Fig. 31	PTL-87-499	B-499	Nylon	White	-	1.000 (25.4)	1.750 (44.5)	1	250	R4310
TLS, BMP71*	Fig. 31	PTL-160-499	B-499	Nylon	White	-	1.750 (44.5)	1.875 (47.6)	1	100	R4310
TLS, BMP71*	Fig. 29	PTL-78-499	B-499	Nylon	White	-	1.900 (48.3)	1.000 (25.4)	1	250	R4310
TLS, BMP71*	Fig. 31	PTL-161-499	B-499	Nylon	White	-	1.930 (49.0)	3.000 (76.2)	1	100	R4310
TLS, BMP71*	Fig. 29	PTL-81-499	B-499	Nylon	White	-	1.900 (48.3)	0.250 (6.3)	1	750	R4310

See all TLS2200® and PC Link™ Ribbon parts on page 323.

\* Yellow media adaptor required for use in the BMP®71 printer. See page 324.



## Polyester Labels for General Industrial ID (B-422, B-423, B-430, B-432, B-483, B-489, B-498)

White or clear label stock with choice of finish and adhesives for smooth or rough surfaces. Use for a wide variety of asset identification, panel labeling and general ID.

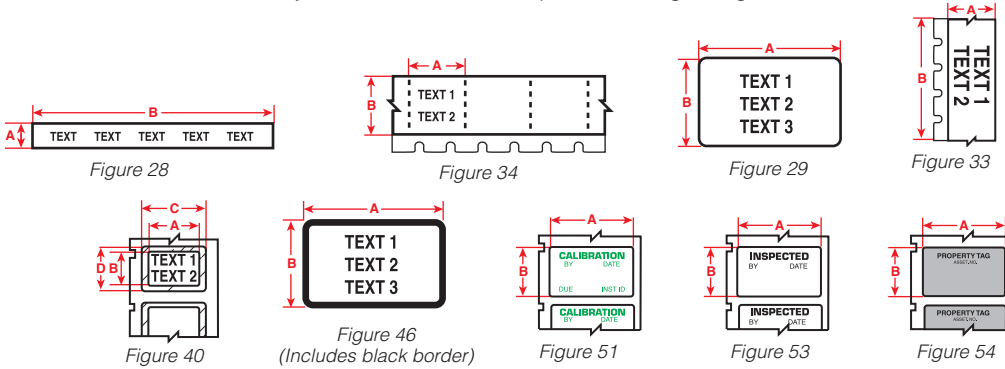

Fits Printer Models	Diagram	Catalog #	B-#	Material	Color	Label Width A Inch (mm)	Label Height B Inch (mm)	Labels Per Row	Labels Per Roll	Rec. Ribbon
<b>Standard adhesive (B-423 gloss white):</b>										
TLS, BMP71*	Fig. 29	PTL-1-423	B-423	Polyester	White	0.250 (6.4)	0.250 (6.4)	1	750	R6010
TLS, BMP71*	Fig. 29	PTL-3-423	B-423	Polyester	White	0.375 (9.5)	0.375 (9.5)	1	500	R6010
TLS, BMP71*	Fig. 29	PTL-4-423	B-423	Polyester	White	0.400 (10.6)	0.400 (10.2)	1	500	R6010
TLS, BMP71*	Fig. 29	PTL-5-423	B-423	Polyester	White	0.500 (12.7)	0.200 (5.1)	1	750	R6010
TLS, BMP71*	Fig. 53	PTL-6-423	B-423	Polyester	White	0.500 (12.7)	0.275 (7.0)	1	750	R6010
TLS, BMP71*	Fig. 29	BM71-7-423	B-423	Polyester	White	0.500 (12.7)	0.500 (12.7)	1	5000	R6010
TLS, BMP71*	Fig. 29	PTL-7-423	B-423	Polyester	White	0.500 (12.7)	0.500 (12.7)	1	500	R6010
TLS, BMP71*	Fig. 33	PTL-8-423	B-423	Polyester	White	0.500 (12.7)	50 ft. (15.2 m)	1	1 Roll Cont.	R6010
TLS, BMP71*	Fig. 29	PTL-9-423	B-423	Polyester	White	0.650 (16.5)	0.200 (5.1)	1	750	R6010
TLS, BMP71*	Fig. 29	PTL-10-423	B-423	Polyester	White	0.750 (19.1)	0.250 (6.4)	1	750	R6010
TLS, BMP71*	Fig. 29	PTL-13-423	B-423	Polyester	White	0.900 (22.9)	0.250 (6.4)	1	750	R6010
TLS, BMP71*	Fig. 29	PTL-14-423	B-423	Polyester	White	1.000 (25.4)	0.187 (4.8)	1	750	R6010
TLS, BMP71*	Fig. 29	PTL-15-423	B-423	Polyester	White	1.000 (25.4)	0.275 (7.0)	1	750	R6010
TLS, BMP71*	Fig. 29	BM71-16-423	B-423	Polyester	White	1.000 (25.4)	0.375 (9.5)	1	5000	R6010
TLS, BMP71*	Fig. 29	PTL-16-423	B-423	Polyester	White	1.000 (25.4)	0.375 (9.5)	1	500	R6010
TLS, BMP71*	Fig. 29	BM71-17-423	B-423	Polyester	White	1.000 (25.4)	0.500 (12.7)	1	5000	R6010
TLS, BMP71*	Fig. 29	PTL-17-423	B-423	Polyester	White	1.000 (25.4)	0.500 (12.7)	1	500	R6010
TLS, BMP71*	Fig. 29	BM71-19-423	B-423	Polyester	White	1.000 (25.4)	1.000 (25.4)	1	2500	R6010
TLS, BMP71*	Fig. 29	PTL-19-423	B-423	Polyester	White	1.000 (25.4)	1.000 (25.4)	1	250	R6010
TLS, BMP71*	Fig. 29	BM71-20-423	B-423	Polyester	White	1.000 (25.4)	2.000 (50.8)	1	1000	R6010
TLS, BMP71*	Fig. 46	PTL-24-423-BK	B-423	Polyester	White	1.130 (28.7)	0.500 (12.7)	1	500	R6010
TLS, BMP71*	Fig. 29	PTL-25-423	B-423	Polyester	White	1.250 (31.8)	0.250 (6.4)	1	750	R6010
TLS, BMP71*	Fig. 29	PTL-27-423	B-423	Polyester	White	1.500 (38.1)	0.125 (3.2)	1	750	R6010
TLS, BMP71*	Fig. 29	PTL-28-423	B-423	Polyester	White	1.500 (38.1)	0.250 (6.4)	1	750	R6010
TLS, BMP71*	Fig. 29	BM71-29-423	B-423	Polyester	White	1.500 (38.1)	0.500 (12.7)	1	5000	R6010
TLS, BMP71*	Fig. 29	PTL-29-423	B-423	Polyester	White	1.500 (38.1)	0.500 (12.7)	1	500	R6010
TLS, BMP71*	Fig. 51	PTL-30-423-CALI	B-423	Polyester	White	1.500 (38.1)	0.750 (19.1)	1	250	R6010
TLS, BMP71*	Fig. 29	PTL-31-423	B-423	Polyester	White	1.500 (38.1)	1.000 (25.4)	1	250	R6010
TLS, BMP71*	Fig. 29	PTL-32-423	B-423	Polyester	White	1.500 (38.1)	1.500 (38.1)	1	250	R6010
TLS, BMP71*	Fig. 29	PTL-2-423	B-423	Polyester	White	2.000 (50.8)	0.250 (6.4)	1	100	R6010
TLS, BMP71*	Fig. 29	PTL-20-423	B-423	Polyester	White	2.000 (50.8)	1.000 (25.4)	1	100	R6010
TLS, BMP71*	Fig. 29	PTL-26-423	B-423	Polyester	White	2.750 (69.9)	1.250 (31.8)	1	100	R6010
TLS, BMP71*	Fig. 29	PTL-22-423	B-423	Polyester	White	3.000 (76.2)	1.000 (25.4)	1	100	R6010
TLS, BMP71*	Fig. 29	PTL-37-423	B-423	Polyester	White	3.000 (76.2)	1.900 (48.3)	1	100	R6010
TLS, BMP71*	Fig. 29	PTL-23-423	B-423	Polyester	White	4.000 (101.6)	1.000 (25.4)	1	100	R6010
TLS, BMP71*	Fig. 29	PTL-38-423	B-423	Polyester	White	4.000 (101.6)	1.900 (48.3)	1	100	R6010
<b>Standard adhesive (B-430 clear):</b>										
TLS, BMP71*	Fig. 33	PTL-46-430	B-430	Polyester	Clear	0.375 (9.5)	50 ft. (15.2 m)	1	1 Roll Cont.	R6010
TLS, BMP71*	Fig. 53	PTL-6-430	B-430	Polyester	Clear	0.500 (12.7)	0.275 (7.0)	1	750	R6010
TLS, BMP71*	Fig. 29	PTL-44-430	B-430	Polyester	Clear	0.500 (12.7)	0.375 (9.5)	1	500	R6010
TLS, BMP71*	Fig. 29	PTL-7-430	B-430	Polyester	Clear	0.500 (12.7)	0.500 (12.7)	1	500	R6010
TLS, BMP71*	Fig. 33	PTL-8-430	B-430	Polyester	Clear	0.500 (12.7)	50 ft. (15.2 m)	1	1 Roll Cont.	R6010
TLS, BMP71*	Fig. 29	PTL-16-430	B-430	Polyester	Clear	1.000 (25.4)	0.375 (9.5)	1	500	R6010
TLS, BMP71*	Fig. 29	PTL-17-430	B-430	Polyester	Clear	1.000 (25.4)	0.500 (12.7)	1	500	R6010
TLS, BMP71*	Fig. 33	PTL-42-430	B-430	Polyester	Clear	1.000 (25.4)	50 ft. (15.2 m)	1	1 Roll Cont.	R6010
TLS, BMP71*	Fig. 29	PTL-45-430	B-430	Polyester	Clear	1.050 (38.1)	0.375 (9.5)	1	500	R6010
TLS, BMP71*	Fig. 29	PTL-28-430	B-430	Polyester	Clear	1.500 (38.1)	0.250 (6.4)	1	750	R6010
TLS, BMP71*	Fig. 29	PTL-29-430	B-430	Polyester	Clear	1.500 (38.1)	0.500 (12.7)	1	500	R6010
TLS, BMP71*	Fig. 33	PTL-43-430	B-430	Polyester	Clear	1.900 (48.3)	50 ft. (15.2 m)	1	1 Roll Cont.	R6010

See all TLS2200® and PC Link™ Ribbon parts on page 323.

\* Yellow media adaptor required for use in the BMP®71 printer. See page 324.



Fits Printer Models	Diagram	Catalog #	B-#	Material	Color	Label Width A Inch (mm)	Label Height B Inch (mm)	Labels Per Row	Labels Per Roll	Rec. Ribbon
<b>Stronger adhesive for textured surfaces (B-422 gloss white):</b>										
TLS, BMP71*	Fig. 34	PTL-39-422	B-422	Polyester	White	0.375 (9.5)	0.600 (15.2)	1	750	R6010
TLS, BMP71*	Fig. 33	PTL-46-422	B-422	Polyester	White	0.375 (9.5)	50 ft. (15.2 m)	1	1 Roll Cont.	R6010
TLS, BMP71*	Fig. 29	PTL-5-422	B-422	Polyester	White	0.500 (12.7)	0.200 (5.1)	1	750	R6010
TLS, BMP71*	Fig. 29	PTL-44-422	B-422	Polyester	White	0.500 (12.7)	0.375 (9.5)	1	500	R6010
TLS, BMP71*	Fig. 29	PTL-7-422	B-422	Polyester	White	0.500 (12.7)	0.500 (12.7)	1	500	R6010
TLS, BMP71*	Fig. 33	PTL-8-422	B-422	Polyester	White	0.500 (12.7)	50 ft. (15.2 m)	1	1 Roll Cont.	R6010
TLS, BMP71*	Fig. 29	PTL-16-422	B-422	Polyester	White	1.000 (25.4)	0.375 (9.5)	1	500	R6010
TLS, BMP71*	Fig. 29	PTL-17-422	B-422	Polyester	White	1.000 (25.4)	0.500 (12.7)	1	500	R6010
TLS, BMP71*	Fig. 40	PTPSL-17-422	B-422	Polyester	White	1.000 (25.4)	0.500 (12.7)	1	500	R6010
TLS, BMP71*	Fig. 29	PTL-19-422	B-422	Polyester	White	1.000 (25.4)	1.000 (25.4)	1	250	R6010
TLS, BMP71*	Fig. 29	BM71-20-422	B-422	Polyester	White	1.000 (25.4)	2.000 (50.8)	1	1000	R6010
TLS, BMP71*	Fig. 33	PTL-42-422	B-422	Polyester	White	1.000 (25.4)	50 ft. (15.2 m)	1	1 Roll Cont.	R6010
TLS, BMP71*	Fig. 29	PTL-45-422	B-422	Polyester	White	1.050 (38.1)	0.375 (9.5)	1	500	R6010
TLS, BMP71*	Fig. 29	PTL-29-422	B-422	Polyester	White	1.050 (38.1)	0.500 (12.7)	1	500	R6010
TLS, BMP71*	Fig. 29	PTL-30-422	B-422	Polyester	White	1.500 (38.1)	0.750 (19.1)	1	250	R6010
TLS, BMP71*	Fig. 29	PTL-32-422	B-422	Polyester	White	1.500 (38.1)	1.500 (38.1)	1	250	R6010
TLS, BMP71*	Fig. 33	PTL-43-422	B-422	Polyester	White	1.900 (48.3)	50 ft. (15.2 m)	1	1 Roll Cont.	R6010
TLS, BMP71*	Fig. 29	PTL-20-422	B-422	Polyester	White	2.000 (50.8)	1.000 (25.4)	1	100	R6010
TLS, BMP71*	Fig. 40	PTPSL-20-422	B-422	Polyester	White	2.000 (50.8)	1.000 (25.4)	1	100	R6010
TLS, BMP71*	Fig. 40	PTPSL-26-422	B-422	Polyester	White	2.750 (69.9)	1.250 (31.8)	1	100	R6010
TLS, BMP71*	Fig. 29	PTL-22-422	B-422	Polyester	White	3.000 (76.2)	1.000 (25.4)	1	100	R6010
TLS, BMP71*	Fig. 40	PTPSL-50-422	B-422	Polyester	White	3.000 (76.2)	1.650 (41.9)	1	100	R6010
TLS, BMP71*	Fig. 29	PTL-37-422	B-422	Polyester	White	3.000 (76.2)	1.900 (48.3)	1	100	R6010
TLS, BMP71*	Fig. 29	PTL-23-422	B-422	Polyester	White	4.000 (101.6)	1.000 (25.4)	1	100	R6010
TLS, BMP71*	Fig. 29	PTL-38-422	B-422	Polyester	White	4.000 (101.6)	1.900 (48.3)	1	100	R6010
TLS, BMP71*	Fig. 54	PTL-35-422-PPROP	B-422	Polyester	Gray	1.630 (41.4)	0.750 (19.1)	1	250	R6010
<b>Stronger adhesive for textured surfaces (B-432 clear):</b>										
TLS, BMP71*	Fig. 33	PTL-8-432	B-432	Polyester	Clear	0.500 (12.7)	50 ft. (15.2 m)	1	1 Roll Cont.	R6010
TLS, BMP71*	Fig. 29	PTL-10-432	B-432	Polyester	Clear	0.750 (19.1)	0.250 (6.4)	1	750	R6010
TLS, BMP71*	Fig. 29	PTL-11-432	B-432	Polyester	Clear	0.750 (19.1)	0.500 (12.7)	1	500	R6010
TLS, BMP71*	Fig. 29	PTL-17-432	B-432	Polyester	Clear	1.000 (25.4)	0.500 (12.7)	1	500	R6010
TLS, BMP71*	Fig. 33	PTL-42-432	B-432	Polyester	Clear	1.000 (25.4)	50 ft. (15.2 m)	1	1 Roll Cont.	R6010
TLS, BMP71*	Fig. 33	PTL-43-432	B-432	Polyester	Clear	1.900 (48.3)	50 ft. (15.2 m)	1	1 Roll Cont.	R6010
<b>Ultra aggressive adhesive for highly textured surfaces (B-483 gloss white):</b>										
TLS, BMP71*	Fig. 33	PTL-101-483	B-483	Polyester	White	0.250 (6.4)	50 ft. (15.2 m)	1	1 Roll Cont.	R6010
TLS, BMP71*	Fig. 33	PTL-8-483	B-483	Polyester	White	0.500 (12.7)	50 ft. (15.2 m)	1	1 Roll Cont.	R6010
TLS, BMP71*	Fig. 29	PTL-16-483	B-483	Polyester	White	1.000 (25.4)	0.375 (9.5)	1	500	R6010
TLS, BMP71*	Fig. 29	PTL-17-483	B-483	Polyester	White	1.000 (25.4)	0.500 (12.7)	1	500	R6010
TLS, BMP71*	Fig. 29	PTL-19-483	B-483	Polyester	White	1.000 (25.4)	1.000 (25.4)	1	250	R6010
TLS, BMP71*	Fig. 33	PTL-42-483	B-483	Polyester	White	1.000 (25.4)	50 ft. (15.2 m)	1	1 Roll Cont.	R6010
TLS, BMP71*	Fig. 46	PTL-24-483-BK	B-483	Polyester	White	1.130 (28.7)	0.500 (12.7)	1	500	R6010
TLS, BMP71*	Fig. 33	PTL-100-483	B-483	Polyester	White	1.300 (33.0)	50 ft. (15.2 m)	1	1 Roll Cont.	R6010
TLS, BMP71*	Fig. 29	PTL-65-483	B-483	Polyester	White	1.375 (34.9)	1.000 (25.4)	1	250	R6010
TLS, BMP71*	Fig. 29	PTL-29-483	B-483	Polyester	White	1.500 (38.1)	0.500 (12.7)	1	500	R6010
TLS, BMP71*	Fig. 29	PTL-30-483	B-483	Polyester	White	1.500 (38.1)	0.750 (19.1)	1	250	R6010
TLS, BMP71*	Fig. 29	PTL-31-483	B-483	Polyester	White	1.500 (38.1)	1.000 (25.4)	1	250	R6010
TLS, BMP71*	Fig. 29	PTL-32-483	B-483	Polyester	White	1.500 (38.1)	1.500 (38.1)	1	250	R6010
TLS, BMP71*	Fig. 33	PTL-43-483	B-483	Polyester	White	1.900 (48.3)	50 ft. (15.2 m)	1	1 Roll Cont.	R6010
TLS, BMP71*	Fig. 28	PTL-61-483	B-483	Polyester	White	2.000 (50.8)	0.500 (12.7)	1	100	R6010
TLS, BMP71*	Fig. 29	PTL-20-483	B-483	Polyester	White	2.000 (50.8)	1.000 (25.4)	1	100	R6010
TLS, BMP71*	Fig. 29	PTL-37-483	B-483	Polyester	White	3.000 (76.2)	1.900 (48.3)	1	100	R6010
TLS, BMP71*	Fig. 29	PTL-62-483	B-483	Polyester	White	4.000 (101.6)	0.750 (19.1)	1	50	R6010
TLS, BMP71*	Fig. 29	PTL-23-483	B-483	Polyester	White	4.000 (101.6)	1.000 (25.4)	1	100	R6010
TLS, BMP71*	Fig. 29	PTL-63-483	B-483	Polyester	White	8.000 (101.6)	0.750 (19.1)	1	50	R6010
<b>Ultra aggressive adhesive for highly textured surfaces (B-489 matte white):</b>										
TLS, BMP71*	Fig. 33	PTL-101-489	B-489	Polyester	White	0.250 (6.4)	50 ft. (15.2 m)	1	1 Roll Cont.	R4310
TLS, BMP71*	Fig. 33	PTL-8-489	B-489	Polyester	White	0.500 (12.7)	50 ft. (15.2 m)	1	1 Roll Cont.	R4310
TLS, BMP71*	Fig. 29	PTL-16-489	B-489	Polyester	White	1.000 (25.4)	0.375 (9.5)	1	500	R4310
TLS, BMP71*	Fig. 29	PTL-17-489	B-489	Polyester	White	1.000 (25.4)	0.500 (12.7)	1	500	R4310
TLS, BMP71*	Fig. 29	PTL-19-489	B-489	Polyester	White	1.000 (25.4)	1.000 (25.4)	1	250	R4310
TLS, BMP71*	Fig. 33	PTL-42-489	B-489	Polyester	White	1.000 (25.4)	50 ft. (15.2 m)	1	1 Roll Cont.	R4310
TLS, BMP71*	Fig. 33	PTL-100-489	B-489	Polyester	White	1.300 (33.0)	50 ft. (15.2 m)	1	1 Roll Cont.	R4310
TLS, BMP71*	Fig. 29	PTL-29-489	B-489	Polyester	White	1.500 (38.1)	0.500 (12.7)	1	500	R4310
TLS, BMP71*	Fig. 29	PTL-30-489	B-489	Polyester	White	1.500 (38.1)	0.750 (19.1)	1	250	R4310
TLS, BMP71*	Fig. 29	PTL-31-489	B-489	Polyester	White	1.500 (38.1)	1.000 (25.4)	1	250	R4310
TLS, BMP71*	Fig. 29	PTL-32-489	B-489	Polyester	White	1.500 (38.1)	1.500 (38.1)	1	250	R4310
TLS, BMP71*	Fig. 33	PTL-43-489	B-489	Polyester	White	1.900 (48.3)	50 ft. (15.2 m)	1	1 Roll Cont.	R4310
TLS, BMP71*	Fig. 29	PTL-20-489	B-489	Polyester	White	2.000 (50.8)	1.000 (25.4)	1	100	R4310
TLS, BMP71*	Fig. 29	PTL-37-489	B-489	Polyester	White	3.000 (76.2)	1.900 (48.3)	1	100	R4310
TLS, BMP71*	Fig. 29	PTL-38-489	B-489	Polyester	White	4.000 (101.6)	1.900 (48.3)	1	100	R4310
<b>Chemical resistant (B-488 matte white):</b>										
TLS, BMP71*	Fig. 29	PTL-80-488	B-488	Polyester	White	0.750 (19.1)	0.900 (22.9)	1	250	R4310
TLS, BMP71*	Fig. 29	PTL-97-488	B-488	Polyester	White	0.900 (22.9)	0.900 (22.9)	1	250	R4310
TLS, BMP71*	Fig. 29	PTL-81-488	B-488	Polyester	White	1.900 (48.3)	0.250 (6.3)	1	750	R4310
TLS, BMP71*	Fig. 29	PTL-78-488	B-488	Polyester	White	1.900 (48.3)	1.000 (25.4)	1	250	R4310

See all TLS2200® and PC Link™ Ribbon parts on page 323.

\* Yellow media adaptor required for use in the BMP®71 printer. See page 324.



# TLS2200® Materials

BradyID.com/tls2200

## Metallized Polyester Labels (B-428, B-435, B-486)

Metallized polyester material designed for high adhesion to textured metals, powder coated surfaces and low surface energy plastics. Withstands numerous solvents and variable temps. Choose from two adhesives for smooth or textured surfaces.

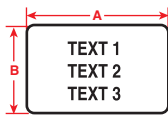

Figure 29

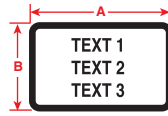

Figure 46  
(Includes black border)

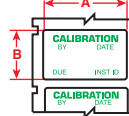

Figure 51

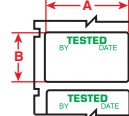

Figure 52

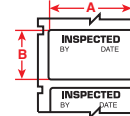

Figure 53

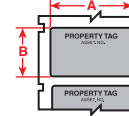

Figure 54

Fits Printer Models	Diagram	Part Number	B-#	Material	Color	Label Width A Inch (mm)	Label Height B Inch (mm)	Labels Per Row	Labels Per Roll	Rec. Ribbon
<b>Standard adhesive for smooth surfaces (B-428 matte):</b>										
TLS, BMP71*	Fig. 33	PTL-8-428	B-428	Polyester	Silver	0.500 (12.7)	50 ft. (15.2 m)	1	1 Roll Cont.	R4310
TLS, BMP71*	Fig. 29	BM71-17-428	B-428	Polyester	Silver	1.000 (25.4)	0.500 (12.7)	1	5000	R4310
TLS, BMP71*	Fig. 29	BM71-20-428	B-428	Polyester	Silver	1.000 (25.4)	2.000 (50.8)	1	1000	R4310
TLS, BMP71*	Fig. 29	PTL-15-428	B-428	Polyester	Silver	1.000 (25.4)	0.275 (7.0)	1	750	R4310
TLS, BMP71*	Fig. 29	PTL-17-428	B-428	Polyester	Silver	1.000 (25.4)	0.500 (12.7)	1	500	R4310
TLS, BMP71*	Fig. 40	PTPSL-17-428	B-428	Polyester	Silver	1.000 (25.4)	0.500 (12.7)	1	500	R4310
TLS, BMP71*	Fig. 46	PTL-24-428-BK	B-428	Polyester	Silver (blk border)	1.130 (28.7)	0.500 (12.7)	1	500	R4310
TLS, BMP71*	Fig. 29	PTL-29-428	B-428	Polyester	Silver	1.500 (38.1)	0.500 (12.7)	1	500	R4310
TLS, BMP71*	Fig. 51	PTL-30-428-CALI	B-428	Polyester	White w/ Text	1.500 (38.1)	0.750 (19.1)	1	250	R4310
TLS, BMP71*	Fig. 53	PTL-30-428-INSP	B-428	Polyester	White w/ Text	1.500 (38.1)	0.750 (19.1)	1	250	R4310
TLS, BMP71*	Fig. 52	PTL-30-428-TEST	B-428	Polyester	White w/ Text	1.500 (38.1)	0.750 (19.1)	1	250	R4310
TLS, BMP71*	Fig. 54	PTL-35-428-PROP	B-428	Polyester	Silver	1.630 (41.4)	0.750 (19.1)	1	250	R4310
TLS, BMP71*	Fig. 29	PTL-20-428	B-428	Polyester	Silver	2.000 (50.8)	1.000 (25.4)	1	100	R4310
TLS, BMP71*	Fig. 40	PTPSL-20-428	B-428	Polyester	Silver	2.000 (50.8)	1.000 (25.4)	1	100	R4310
TLS, BMP71*	Fig. 29	PTL-26-428	B-428	Polyester	Silver	2.750 (69.9)	1.250 (31.8)	1	100	R4310
TLS, BMP71*	Fig. 40	PTPSL-26-428	B-428	Polyester	Silver	2.750 (69.9)	1.250 (31.8)	1	100	R4310
TLS, BMP71*	Fig. 29	PTL-22-428	B-428	Polyester	Silver	3.000 (76.2)	1.000 (25.4)	1	100	R4310
TLS, BMP71*	Fig. 29	PTL-37-428	B-428	Polyester	Silver	3.000 (76.2)	1.900 (48.3)	1	100	R4310
TLS, BMP71*	Fig. 40	PTPSL-50-428	B-428	Polyester	Silver	3.000 (76.2)	1.650 (41.9)	1	100	R4310
TLS, BMP71*	Fig. 29	PTL-38-428	B-428	Polyester	Silver	4.000 (101.6)	1.900 (48.3)	1	100	R4310
<b>Standard adhesive for smooth surfaces (B-435 glossy):</b>										
TLS, BMP71*	Fig. 29	PTL-16-435	B-435	Polyester	Silver	1.000 (25.4)	0.375 (9.5)	1	500	R6010
TLS, BMP71*	Fig. 29	PTL-17-435	B-435	Polyester	Silver	1.000 (25.4)	0.500 (12.7)	1	500	R6010
TLS, BMP71*	Fig. 29	PTL-29-435	B-435	Polyester	Silver	1.500 (38.1)	0.500 (12.7)	1	500	R6010
TLS, BMP71*	Fig. 29	PTL-30-435	B-435	Polyester	Silver	1.500 (38.1)	0.750 (19.1)	1	250	R6010
TLS, BMP71*	Fig. 29	PTL-31-435	B-435	Polyester	Silver	1.500 (38.1)	1.000 (25.4)	1	250	R6010
TLS, BMP71*	Fig. 29	PTL-32-435	B-435	Polyester	Silver	1.500 (38.1)	1.500 (38.1)	1	250	R6010
TLS, BMP71*	Fig. 29	PTL-20-435	B-435	Polyester	Silver	2.000 (50.8)	1.000 (25.4)	1	100	R6010
TLS, BMP71*	Fig. 29	PTL-37-435	B-435	Polyester	Silver	3.000 (76.2)	1.900 (48.3)	1	100	R6010
TLS, BMP71*	Fig. 29	PTL-38-435	B-435	Polyester	Silver	4.000 (101.6)	1.900 (48.3)	1	100	R6010
<b>Ultra aggressive adhesive for highly textured, powder coated and low surface energy surfaces (B-486 matte):</b>										
TLS, BMP71*	Fig. 29	PTL-16-486	B-486	Polyester	Lt. Silver	1.000 (25.4)	0.375 (9.5)	1	500	R4310
TLS, BMP71*	Fig. 29	PTL-17-486	B-486	Polyester	Lt. Silver	1.000 (25.4)	0.500 (12.7)	1	500	R4310
TLS, BMP71*	Fig. 29	PTL-19-486	B-486	Polyester	Lt. Silver	1.000 (25.4)	1.000 (25.4)	1	250	R4310
TLS, BMP71*	Fig. 46	PTL-24-486-BK	B-486	Polyester	Silver (blk border)	1.130 (28.7)	0.500 (12.7)	1	500	R4310
TLS, BMP71*	Fig. 29	PTL-29-486	B-486	Polyester	Lt. Silver	1.500 (38.1)	0.500 (12.7)	1	500	R4310
TLS, BMP71*	Fig. 29	PTL-30-486	B-486	Polyester	Lt. Silver	1.500 (38.1)	0.750 (19.1)	1	250	R4310
TLS, BMP71*	Fig. 29	PTL-31-486	B-486	Polyester	Lt. Silver	1.500 (38.1)	1.000 (25.4)	1	250	R4310
TLS, BMP71*	Fig. 29	PTL-32-486	B-486	Polyester	Lt. Silver	1.500 (38.1)	1.500 (38.1)	1	250	R4310
TLS, BMP71*	Fig. 29	PTL-20-486	B-486	Polyester	Lt. Silver	2.000 (50.8)	1.000 (25.4)	1	100	R4310
TLS, BMP71*	Fig. 29	PTL-37-486	B-486	Polyester	Lt. Silver	3.000 (76.2)	1.900 (48.3)	1	100	R4310
TLS, BMP71*	Fig. 29	PTL-38-486	B-486	Polyester	Lt. Silver	4.000 (101.6)	1.900 (48.3)	1	100	R4310

See all TLS2200® and PC Link™ Ribbon parts on page 323.

\* Yellow media adaptor required for use in the BMP®71 printer. See page 324.

## VOID Footprint Polyester Labels (B-7546, B-7566, B-7576)

White glossy polyester tamper-indicating material leaves a “VOID” footprint when label is removed to prevent reuse. Adhesive doesn’t allow repositioning and requires minimal handling in order to prevent a premature “VOID” pattern.

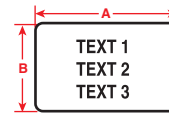

Figure 29



Fits Printer Models	Diagram	Part Number	B-#	Material	Color	Label Width A Inch (mm)	Label Height B Inch (mm)	Labels Per Row	Labels Per Roll	Rec. Ribbon
TLS, BMP71*	Fig. 29	PTL-17-7546	B-7546	Polyester	White	1.000 (25.4)	0.500 (12.7)	1	500	R6010
TLS, BMP71*	Fig. 29	PTL-31-7546	B-7546	Polyester	White	1.500 (38.1)	1.000 (25.4)	1	250	R6010
TLS, BMP71*	Fig. 29	PTL-20-7546	B-7546	Polyester	White	2.000 (50.8)	1.000 (25.4)	1	100	R6010
TLS, BMP71*	Fig. 29	PTL-17-7566	B-7566	Polyester	Clear	1.000 (25.4)	0.500 (12.7)	1	500	R6010
TLS, BMP71*	Fig. 29	PTL-30-7566	B-7566	Polyester	Clear	1.500 (38.1)	0.750 (19.1)	1	250	R6010
TLS, BMP71*	Fig. 29	PTL-31-7566	B-7566	Polyester	Clear	1.500 (38.1)	1.000 (25.4)	1	250	R6010
TLS, BMP71*	Fig. 29	PTL-17-7576	B-7576	Polyester	Silver	1.000 (25.4)	0.500 (12.7)	1	500	R6010
TLS, BMP71*	Fig. 29	PTL-31-7576	B-7576	Polyester	Silver	1.500 (38.1)	1.000 (25.4)	1	250	R6010
TLS, BMP71*	Fig. 29	PTL-20-7576	B-7576	Polyester	Silver	2.000 (50.8)	1.000 (25.4)	1	100	R6010
TLS, BMP71*	Fig. 29	PTL-37-7576	B-7576	Polyester	Silver	3.000 (76.2)	1.900 (48.3)	1	100	R6010

## Destructible Vinyl Labels (B-351)

White matte vinyl material with permanent adhesive. Material fractures to show signs of tampering and prevent one-piece label removal. Use caution when removing from liner as material is fragile.

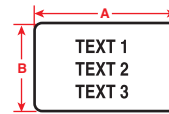

Figure 29



Fits Printer Models	Diagram	Part Number	B-#	Material	Color	Label Width A Inch (mm)	Label Height B Inch (mm)	Labels Per Row	Labels Per Roll	Rec. Ribbon
TLS, BMP71*	Fig. 29	PTL-17-351	B-351	Vinyl	White	1.000 (25.4)	0.500 (12.7)	1	500	R6210
TLS, BMP71*	Fig. 29	PTL-31-351	B-351	Vinyl	White	1.500 (38.1)	1.000 (25.4)	1	250	R6210
TLS, BMP71*	Fig. 29	PTL-20-351	B-351	Vinyl	White	2.000 (50.8)	1.000 (25.4)	1	100	R6210
TLS, BMP71*	Fig. 29	PTL-37-351	B-351	Vinyl	White	3.000 (76.2)	1.900 (48.3)	1	100	R6210

## Paper Labels for General ID (B-424)

White paper material with matte finish and smooth top coat finish for thermal transfer printing. Good contrast and smear resistance for thermal barcode printing. Used for general purpose labeling applications.

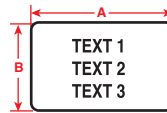

Figure 29

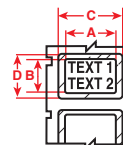

Figure 40



Fits Printer Models	Diagram	Part Number	B-#	Material	Color	Label Width A Inch (mm)	Label Height B Inch (mm)	Labels Per Row	Labels Per Roll	Rec. Ribbon
TLS, BMP71*	Fig. 29	PTL-80-424	B-424	Paper	White	0.750 (19.1)	0.900 (22.9)	1	250	R4310
TLS, BMP71*	Fig. 29	BM71-20-424	B-424	Paper	White	1.000 (25.4)	2.000 (50.8)	1	1000	R4310
TLS, BMP71*	Fig. 40	PTPSL-17-424	B-424	Paper	White	1.000 (25.4)	0.500 (12.7)	1	500	R4310
TLS, BMP71*	Fig. 29	PTL-20-424	B-424	Paper	White	2.000 (50.8)	1.000 (25.4)	1	100	R4310
TLS, BMP71*	Fig. 40	PTPSL-20-424	B-424	Paper	White	2.000 (50.8)	1.000 (25.4)	1	100	R4310
TLS, BMP71*	Fig. 29	PTL-22-424	B-424	Paper	White	3.000 (76.2)	1.000 (25.4)	1	100	R4310
TLS, BMP71*	Fig. 29	PTL-37-424	B-424	Paper	White	3.000 (76.2)	1.900 (48.3)	1	100	R4310
TLS, BMP71*	Fig. 29	PTL-38-424	B-424	Paper	White	4.000 (101.6)	1.900 (48.3)	1	100	R4310

See all TLS2200® and PC Link™ Ribbon parts on page 323.

\* Yellow media adaptor required for use in the BMP®71 printer. See page 324.



## Raised Profile Labels - Engraved Plate Substitutes - Push Button Style (B-593)

Glossy, foam-backed polyester with permanent adhesive, coined a "raised panel" label. Ideal for external push-buttons, switches, and internal connection points. Can be printed with alphanumeric characters for use as rating and serial plates. Available in white, black, yellow, red, green and silver.

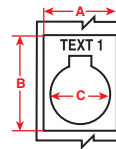

Figure 49



Fits Printer Models	Diagram	Part Number	B-#	Material	Color	Hole Dia. Inch (mm)	Label Width A Inch (mm)	Label Height B Inch (mm)	Labels Per Row	Labels Per Roll	Rec. Ribbon
TLS, BMP71*	Fig. 49	PTLEP-167-593	B-593	Polyester	White	0.886 (22.5)	1.200 (30.5)	1.500 (38.1)	1	100	R6010
TLS, BMP71*	Fig. 49	PTLEP-168-593	B-593	Polyester	White	0.886 (22.5)	1.200 (30.5)	1.900 (48.3)	1	100	R6010
TLS, BMP71*	Fig. 49	PTLEP-169-593	B-593	Polyester	White	1.200 (30.5)	1.800 (45.7)	1.800 (45.7)	1	100	R6010
TLS, BMP71*	Fig. 49	PTLEP-167-593-YL	B-593	Polyester	Yellow	0.886 (22.5)	1.200 (30.5)	1.500 (38.1)	1	100	R6010
TLS, BMP71*	Fig. 49	PTLEP-168-593-YL	B-593	Polyester	Yellow	0.886 (22.5)	1.200 (30.5)	1.900 (48.3)	1	100	R6010
TLS, BMP71*	Fig. 49	PTLEP-169-593-YL	B-593	Polyester	Yellow	1.200 (30.5)	1.800 (45.7)	1.800 (45.7)	1	100	R6010
TLS, BMP71*	Fig. 49	PTLEP-167-593-BK	B-593	Polyester	Black	0.886 (22.5)	1.200 (30.5)	1.500 (38.1)	1	100	R4410-WT
TLS, BMP71*	Fig. 49	PTLEP-168-593-BK	B-593	Polyester	Black	0.886 (22.5)	1.200 (30.5)	1.900 (48.3)	1	100	R4410-WT
TLS, BMP71*	Fig. 49	PTLEP-169-593-BK	B-593	Polyester	Black	1.200 (30.5)	1.800 (45.7)	1.800 (45.7)	1	100	R4410-WT
TLS, BMP71*	Fig. 49	PTLEP-167-593-GN	B-593	Polyester	Green	0.886 (22.5)	1.200 (30.5)	1.500 (38.1)	1	100	R4410-WT
TLS, BMP71*	Fig. 49	PTLEP-168-593-GN	B-593	Polyester	Green	0.886 (22.5)	1.200 (30.5)	1.900 (48.3)	1	100	R4410-WT
TLS, BMP71*	Fig. 49	PTLEP-169-593-GN	B-593	Polyester	Green	1.200 (30.5)	1.800 (45.7)	1.800 (45.7)	1	100	R4410-WT
TLS, BMP71*	Fig. 49	PTLEP-167-593-RD	B-593	Polyester	Red	0.886 (22.5)	1.200 (30.5)	1.500 (38.1)	1	100	R4410-WT
TLS, BMP71*	Fig. 49	PTLEP-168-593-RD	B-593	Polyester	Red	0.886 (22.5)	1.200 (30.5)	1.900 (48.3)	1	100	R4410-WT
TLS, BMP71*	Fig. 49	PTLEP-169-593-RD	B-593	Polyester	Red	1.200 (30.5)	1.800 (45.7)	1.800 (45.7)	1	100	R4410-WT

## Raised Profile Labels - Engraved Plate Substitutes - Rectangular Style (B-593)

Glossy, foam-backed polyester with permanent adhesive, coined a "raised panel" label. Ideal for external push-buttons, switches, and internal connection points. Can be printed with alphanumeric characters for use as rating and serial plates. Available in white, black, yellow, red, green and silver.

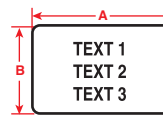

Figure 29



Fits Printer Models	Diagram	Part Number	B-#	Material	Color	Label Width A Inch (mm)	Label Height B Inch (mm)	Labels Per Row	Labels Per Roll	Rec. Ribbon
TLS, BMP71*	Fig. 29	PTLEP-171-593	B-593	Polyester	White	1.060 (26.9)	0.490 (12.5)	1	200	R6010
TLS, BMP71*	Fig. 29	PTLEP-173-593	B-593	Polyester	White	2.000 (50.8)	1.000 (25.4)	1	100	R6010
TLS, BMP71*	Fig. 29	PTLEP-176-593	B-593	Polyester	White	3.000 (76.2)	1.000 (25.4)	1	50	R6010
TLS, BMP71*	Fig. 29	PTLEP-174-593	B-593	Polyester	White	4.000 (101.6)	1.000 (25.4)	1	50	R6010
TLS, BMP71*	Fig. 29	PTLEP-171-593-YL	B-593	Polyester	Yellow	1.060 (26.9)	0.490 (12.5)	1	200	R6010
TLS, BMP71*	Fig. 29	PTLEP-173-593-YL	B-593	Polyester	Yellow	2.000 (50.8)	1.000 (25.4)	1	100	R6010
TLS, BMP71*	Fig. 29	PTLEP-176-593-YL	B-593	Polyester	Yellow	3.000 (76.2)	1.000 (25.4)	1	50	R6010
TLS, BMP71*	Fig. 29	PTLEP-174-593-YL	B-593	Polyester	Yellow	4.000 (101.6)	1.000 (25.4)	1	50	R6010
TLS, BMP71*	Fig. 29	PTLEP-171-593-BK	B-593	Polyester	Black	1.060 (26.9)	0.490 (12.5)	1	200	R4410-WT
TLS, BMP71*	Fig. 29	PTLEP-173-593-BK	B-593	Polyester	Black	2.000 (50.8)	1.000 (25.4)	1	100	R4410-WT
TLS, BMP71*	Fig. 29	PTLEP-176-593-BK	B-593	Polyester	Black	3.000 (76.2)	1.000 (25.4)	1	50	R4410-WT
TLS, BMP71*	Fig. 29	PTLEP-174-593-BK	B-593	Polyester	Black	4.000 (101.6)	1.000 (25.4)	1	50	R4410-WT
TLS, BMP71*	Fig. 29	PTLEP-171-593-GN	B-593	Polyester	Green	1.060 (26.9)	0.490 (12.5)	1	200	R4410-WT
TLS, BMP71*	Fig. 29	PTLEP-173-593-GN	B-593	Polyester	Green	2.000 (50.8)	1.000 (25.4)	1	100	R4410-WT
TLS, BMP71*	Fig. 29	PTLEP-176-593-GN	B-593	Polyester	Green	3.000 (76.2)	1.000 (25.4)	1	50	R4410-WT
TLS, BMP71*	Fig. 29	PTLEP-174-593-GN	B-593	Polyester	Green	4.000 (101.6)	1.000 (25.4)	1	50	R4410-WT
TLS, BMP71*	Fig. 29	PTLEP-171-593-RD	B-593	Polyester	Red	1.060 (26.9)	0.490 (12.5)	1	200	R4410-WT
TLS, BMP71*	Fig. 29	PTLEP-173-593-RD	B-593	Polyester	Red	2.000 (50.8)	1.000 (25.4)	1	100	R4410-WT
TLS, BMP71*	Fig. 29	PTLEP-176-593-RD	B-593	Polyester	Red	3.000 (76.2)	1.000 (25.4)	1	50	R4410-WT
TLS, BMP71*	Fig. 29	PTLEP-174-593-RD	B-593	Polyester	Red	4.000 (101.6)	1.000 (25.4)	1	50	R4410-WT
TLS, BMP71*	Fig. 29	PTLEP-171-593-SL	B-593	Polyester	Silver	1.060 (26.9)	0.490 (12.5)	1	200	R6010
TLS, BMP71*	Fig. 29	PTLEP-173-593-SL	B-593	Polyester	Silver	2.000 (50.8)	1.000 (25.4)	1	100	R6010
TLS, BMP71*	Fig. 29	PTLEP-174-593-SL	B-593	Polyester	Silver	4.000 (101.6)	1.000 (25.4)	1	50	R6010

See all TLS2200® and PC Link™ Ribbon parts on page 323.

\* Yellow media adaptor required for use in the BMP®71 printer. See page 324.

## Pre-Printed Warning Header Labels (B-483)

White polyester thermal transfer material with glossy finish and aggressive adhesive specifically designed for powder coated surfaces.

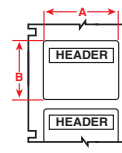

Figure 72  
(Includes pre-printed header)



Fits Printer Model(s)	Diagram	Catalog #	B#	Material	Header	Label Height A Inch (mm)	Label Width B Inch (mm)	Labels Per Row	Labels Per Roll	Rec. Ribbon
TLS, BMP71*	Fig. 72	PTL-37-483-WARNING	B-483	Polyester	WARNING	3.000 (76.2)	1.900 (48.3)	1	100	R6010
TLS, BMP71*	Fig. 72	PTL-38-483-WARNING	B-483	Polyester		4.000 (101.6)	1.900 (48.3)	1	100	R6010

## Faceplate, Outlet and Port Labels (B-412, B-422)

Thick polypropylene material used for equipment identification. Offers high print legibility and high tensile strength.

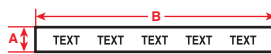

Figure 28

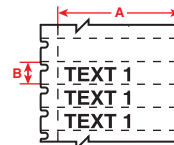

Figure 55



Fits Printer Model(s)	Diagram	Part Number	B-#	Material	Color	Label Width A Inch (mm)	Label Height B Inch (mm)	Labels Per Row	Labels Per Roll	Rec. Ribbon
TLS, BMP71*	Fig. 28	PTL-55-412	B-412	Non-adhesive Strip	White	0.230 (5.8)	50 ft. (15.2 m)	1	1 Roll Cont.	R6210
TLS, BMP71*	Fig. 28	PTL-56-412	B-412	Non-adhesive Strip	White	0.375 (9.5)	50 ft. (15.2 m)	1	1 Roll Cont.	R6210
TLS, BMP71*	Fig. 28	PTL-57-412	B-412	Non-adhesive Strip	White	0.500 (12.7)	50 ft. (15.2 m)	1	1 Roll Cont.	R6210
TLS, BMP71*	Fig. 28	PTL-58-412	B-412	Non-adhesive Strip	White	0.535 (13.6)	50 ft. (15.2 m)	1	1 Roll Cont.	R6210
TLS, BMP71*	Fig. 28	PTL-59-412	B-412	Non-adhesive Strip	White	0.785 (19.9)	50 ft. (15.2 m)	1	1 Roll Cont.	R6210
TLS, BMP71*	Fig. 55	PTL-40-412	B-412	Non-adhesive Strip	White	1.938 (49.2)	0.375 (9.5)	1	750	R6210
TLS, BMP71*	Fig. 55	BM71-40-412	B-412	Non-adhesive Strip	White	1.938 (49.2)	0.375 (9.5)	1	5000	R6210
TLS, BMP71*	Fig. 33	PTL-46-422	B-422	Adhesive Strip	White	0.375 (9.5)	50 ft. (15.2 m)	1	1 Roll Cont.	R6010
TLS, BMP71*	Fig. 33	PTL-8-422	B-422	Adhesive Strip	White	0.500 (12.7)	50 ft. (15.2 m)	1	1 Roll Cont.	R6010
TLS, BMP71*	Fig. 34	PTL-39-422	B-422	Polyester Individual Labels	White	0.375 (9.5)	0.600 (15.2)	1	750	R6010
TLS, BMP71*	Fig. 29	PTL-7-422	B-422	Polyester Individual Labels	White	0.500 (12.7)	0.500 (12.7)	1	500	R6010
TLS, BMP71*	Fig. 29	PTL-16-422	B-422	Polyester Individual Labels	White	1.000 (25.4)	0.375 (9.5)	1	500	R6010
TLS, BMP71*	Fig. 29	PTL-17-422	B-422	Polyester Individual Labels	White	1.000 (25.4)	0.500 (12.7)	1	500	R6010

## Non-Adhesive Polyethylene Tag Material (B-109)

Excellent multi-purpose tag for identifying multiconductor cables, inventory, safety warning repair and work-in-processing manufacturing. Good weatherability, humidity resistance and legibility after solvent exposure.

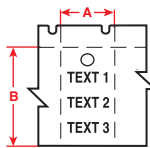

Figure 45

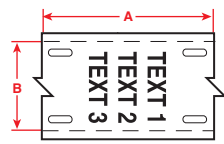

Figure 56



Fits Printer Model(s)	Diagram	Part Number	B-#	Material	Color	Label Width A Inch (mm)	Label Height B Inch (mm)	Labels Per Row	Labels Per Roll	Rec. Ribbon
TLS, BMP71*	Fig. 45	PTL-36-109	B-109	Polyethylene	White	1.125 (28.6)	1.750 (44.5)	1	250	R4310
TLS, BMP71*	Fig. 56	PTL-12-109	B-109	Polyethylene	White	3.000 (76.2)	0.750 (19.1)	1	100	R4310
TLS, BMP71*	Fig. 56	BM71-12-109	B-109	Polyethylene	White	3.000 (76.2)	0.750 (19.1)	1	1000	R4310

See all TLS2200® and PC Link™ Ribbon parts on page 323.

\* Yellow media adaptor required for use in the BMP®71 printer. See page 324.



## Adhesive Cloth Wire & Cable Wraps (B-498)

Adhesive cloth material for wire, cable, and component marking. Repositionable cloth variety offers excellent holding power, while easily being repositioned and removed.

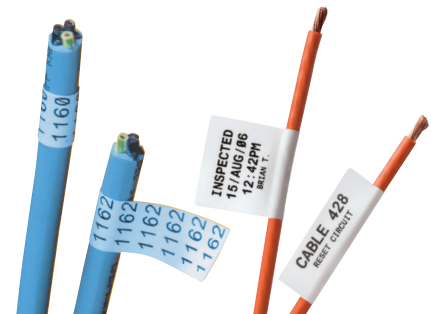
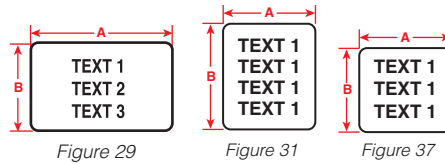

Fits Printer Models	Diagram	Part Number	B-#	Material	Color	Approx. Wire Gauge	Label Width A Inch (mm)	Label Height B Inch (mm)	Labels Per Row	Labels Per Roll	Rec. Ribbon
<b>Repositionable Vinyl Cloth (B-498)</b>											
TLS, BMP71*	Fig. 37	PTL-15-498	B-498	Vinyl Cloth	White	22 to 16	1.000 (25.4)	0.275 (7.0)	1	750	R6210
TLS, BMP71*	Fig. 37	PTL-7-498	B-498	Vinyl Cloth	White	22 to 16	0.500 (12.7)	0.500 (12.7)	1	500	R6210
TLS, BMP71*	Fig. 37	PTL-17-498	B-498	Vinyl Cloth	White	12 to 10	1.000 (25.4)	0.500 (12.7)	1	500	R6210
TLS, BMP71*	Fig. 31	PTL-10-498	B-498	Vinyl Cloth	White	16 to 10	0.250 (6.4)	0.750 (19.1)	1	750	R6210
TLS, BMP71*	Fig. 31	BM71-11-498	B-498	Vinyl Cloth	White	16 to 10	0.500 (12.7)	0.750 (19.1)	1	5000	R6210
TLS, BMP71*	Fig. 31	PTL-11-498	B-498	Vinyl Cloth	White	16 to 10	0.500 (12.7)	0.750 (19.1)	1	500	R6210
TLS, BMP71*	Fig. 31	PTL-16-498	B-498	Vinyl Cloth	White	12 to 10	0.375 (9.5)	1.000 (25.4)	1	500	R6210
TLS, BMP71*	Fig. 31	BM71-18-498	B-498	Vinyl Cloth	White	12 to 10	0.750 (19.1)	1.000 (25.4)	1	2500	R6210
TLS, BMP71*	Fig. 31	PTL-18-498	B-498	Vinyl Cloth	White	12 to 10	0.750 (19.1)	1.000 (25.4)	1	250	R6210
TLS, BMP71*	Fig. 37	BM71-19-498	B-498	Vinyl Cloth	White	12 to 10	1.000 (25.4)	1.000 (25.4)	1	2500	R6210
TLS, BMP71*	Fig. 37	PTL-19-498	B-498	Vinyl Cloth	White	12 to 10	1.000 (25.4)	1.000 (25.4)	1	250	R6210
TLS, BMP71*	Fig. 31	PTL-28-498	B-498	Vinyl Cloth	White	10 to 4	0.250 (6.4)	1.500 (38.1)	1	750	R6210
TLS, BMP71*	Fig. 31	BM71-29-498	B-498	Vinyl Cloth	White	10 to 4	0.500 (12.7)	1.500 (38.1)	1	5000	R6210
TLS, BMP71*	Fig. 31	PTL-30-498	B-498	Vinyl Cloth	White	10 to 4	0.750 (19.1)	1.500 (38.1)	1	250	R6210
TLS, BMP71*	Fig. 31	PTL-31-498	B-498	Vinyl Cloth	White	10 to 4	1.000 (25.4)	1.500 (38.1)	1	250	R6210
TLS, BMP71*	Fig. 37	PTL-32-498	B-498	Vinyl Cloth	White	10 to 4	1.500 (38.1)	1.500 (38.1)	1	250	R6210
TLS, BMP71*	Fig. 31	PTL-21-498	B-498	Vinyl Cloth	White	Cables	1.000 (25.4)	2.500 (63.5)	1	100	R6210
TLS, BMP71*	Fig. 31	PTL-23-498	B-498	Vinyl Cloth	White	Cables	1.000 (25.4)	4.000 (101.6)	1	100	R6210
TLS, BMP71*	Fig. 31	PTL-33-498	B-498	Vinyl Cloth	White	Cables	1.500 (38.1)	4.000 (101.6)	1	100	R6210
TLS, BMP71*	Fig. 31	PTL-34-498	B-498	Vinyl Cloth	White	Cables	1.500 (38.1)	6.000 (152.4)	1	50	R6210
<b>Permanent Adhesive Nylon Cloth (B-499)</b>											
TLS, BMP71*	Fig. 37	PTL-7-499	B-499	Nylon Cloth	White	22 to 16	0.500 (12.7)	0.500 (12.7)	1	500	R4310
TLS, BMP71*	Fig. 31	BM71-11-499	B-499	Nylon Cloth	White	16 to 10	0.500 (12.7)	0.750 (19.1)	1	5000	R4310
TLS, BMP71*	Fig. 31	PTL-11-499	B-499	Nylon Cloth	White	16 to 10	0.500 (12.7)	0.750 (19.1)	1	500	R4310
TLS, BMP71*	Fig. 31	PTL-16-499	B-499	Nylon Cloth	White	12 to 10	0.375 (9.5)	1.000 (25.4)	1	500	R4310
TLS, BMP71*	Fig. 31	PTL-18-499	B-499	Nylon Cloth	White	12 to 10	0.750 (19.1)	1.000 (25.4)	1	250	R4310
TLS, BMP71*	Fig. 37	PTL-19-499	B-499	Nylon Cloth	White	12 to 10	1.000 (25.4)	1.000 (25.4)	1	250	R4310
TLS, BMP71*	Fig. 31	PTL-28-499	B-499	Nylon Cloth	White	10 to 4	0.250 (6.4)	1.500 (38.1)	1	750	R4310
TLS, BMP71*	Fig. 31	PTL-29-498	B-499	Nylon Cloth	White	10 to 4	0.500 (12.7)	1.500 (38.1)	1	500	R6210
TLS, BMP71*	Fig. 31	PTL-29-499	B-499	Nylon Cloth	White	10 to 4	0.500 (12.7)	1.500 (38.1)	1	500	R4310
TLS, BMP71*	Fig. 31	PTL-30-499	B-499	Nylon Cloth	White	10 to 4	0.750 (19.1)	1.500 (38.1)	1	250	R4310
TLS, BMP71*	Fig. 31	PTL-31-499	B-499	Nylon Cloth	White	10 to 4	1.000 (25.4)	1.500 (38.1)	1	250	R4310
TLS, BMP71*	Fig. 31	PTL-21-499	B-499	Nylon Cloth	White	Cables	1.000 (25.4)	2.500 (63.5)	1	100	R4310
TLS, BMP71*	Fig. 31	PTL-23-499	B-499	Nylon Cloth	White	Cables	1.000 (25.4)	4.000 (101.6)	1	100	R4310
TLS, BMP71*	Fig. 29	PTL-84-499	B-499	Nylon Cloth	White	-	0.900 (22.9)	0.500 (12.7)	1	500	R4310
TLS, BMP71*	Fig. 29	PTL-78-499	B-499	Nylon Cloth	White	-	1.900 (48.3)	1.000 (25.4)	1	250	R4310
TLS, BMP71*	Fig. 29	PTL-81-499	B-499	Nylon Cloth	White	-	1.900 (48.3)	0.250 (6.3)	1	750	R4310

## Terminal Block Adhesive Strips (B-498)

Repositionable vinyl cloth material for wire, cable, and component marking. Adhesive and cloth backing offers excellent holding power, while easily being repositioned and removed.

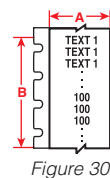

Fits Printer Models	Diagram	Part Number	B-#	Material	Color	Label Width A Inch (mm)	Label Height B Inch (mm)	Labels Per Row	Labels Per Roll	Rec. Ribbon
TLS, BMP71*	Fig. 30	PTLTB-498-318	B-498	Vinyl	White	0.318 (8.1)	30 ft. (9.1 m)	1	1 Roll Cont.	R6210
TLS, BMP71*	Fig. 30	PTLTB-498-375	B-498	Vinyl	White	0.375 (9.5)	30 ft. (9.1 m)	1	1 Roll Cont.	R6210
TLS, BMP71*	Fig. 30	BPTLTB-498-240	B-498	Vinyl	White	0.240 (6.1)	300 ft. (91.4 m)	1	1 Roll Cont.	R6210
TLS, BMP71*	Fig. 30	BPTLTB-498-318	B-498	Vinyl	White	0.318 (8.1)	300 ft. (91.4 m)	1	1 Roll Cont.	R6210
TLS, BMP71*	Fig. 30	BPTLTB-498-375	B-498	Vinyl	White	0.375 (9.5)	300 ft. (91.4 m)	1	1 Roll Cont.	R6210

\*Approx. wire gauge based on AWG for THHN wire.

See all TLS2200® and PC Link™ Ribbon parts on page 323.  
\* Yellow media adaptor required for use in the BMP®71 printer. See page 324.

## Self-Laminating Vinyl Wire & Cable Labels (B-427)

Brady's most popular wire and cable marker. Self-laminating vinyl features white printable area with a clear "tail" that wraps around marker. Tail serves as overlaminates to protect the print. Superior resistance to abrasion, solvents, water, oil and dirt.

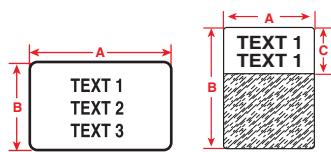

Figure 29

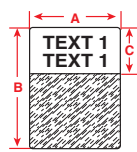

Figure 32



Fits Printer Models	Diagram	Part Number	B-#	Material	Color	Approx. Wire Gauge*	Label Width A Inch (mm)	Label Height B Inch (mm)	Print-On Height C Inch (mm)	Labels Per Row	Labels Per Roll	Rec. Ribbon
TLS, BMP71*	Fig. 29	PTL-105-427-AW	B-427	Vinyl	White	All White	1.100 (27.9)	0.250 (6.4)	0.250 (6.4)	1	750	R4310
TLS, BMP71*	Fig. 32	PTL-10-427	B-427	Vinyl	White	16 to 10	0.250 (6.4)	0.750 (19.1)	0.375 (9.5)	1	750	R4310
TLS, BMP71*	Fig. 32	BM71-11-427	B-427	Vinyl	White	16 to 10	0.500 (12.7)	0.750 (19.1)	0.375 (9.5)	1	5000	R4310
TLS, BMP71*	Fig. 32	PTL-11-427	B-427	Vinyl	White	16 to 10	0.500 (12.7)	0.750 (19.1)	0.375 (9.5)	1	500	R4310
TLS, BMP71*	Fig. 32	PTL-96-427	B-427	Vinyl	White	16 to 10	1.000 (25.4)	0.750 (19.1)	0.375 (9.5)	1	250	R4310
TLS, BMP71*	Fig. 29	PTL-30-427-AW	B-427	Vinyl	White	All White	1.500 (38.1)	0.750 (19.1)	0.750 (19.1)	1	250	R4310
TLS, BMP71*	Fig. 32	BM71-17-427	B-427	Vinyl	White	12 to 10	0.500 (12.7)	1.000 (25.4)	0.375 (9.5)	1	5000	R4310
TLS, BMP71*	Fig. 32	PTL-17-427	B-427	Vinyl	White	12 to 10	0.500 (12.7)	1.000 (25.4)	0.375 (9.5)	1	500	R4310
TLS, BMP71*	Fig. 32	BM71-18-427	B-427	Vinyl	White	10 to 4	0.750 (19.1)	1.000 (25.4)	0.375 (9.5)	1	2500	R4310
TLS, BMP71*	Fig. 32	PTL-18-427	B-427	Vinyl	White	10 to 4	0.750 (19.1)	1.000 (25.4)	0.375 (9.5)	1	250	R4310
TLS, BMP71*	Fig. 32	PTL-19-427	B-427	Vinyl	White	12 to 10	1.000 (25.4)	1.000 (25.4)	0.375 (9.5)	1	250	R4310
TLS, BMP71*	Fig. 32	BM71-19-427	B-427	Vinyl	White	12 to 10	1.000 (25.4)	1.000 (25.4)	0.375 (9.5)	1	2500	R4310
TLS, BMP71*	Fig. 32	PTL-19-642	B-427	Vinyl	White	12 to 10	1.000 (25.4)	1.000 (25.4)	0.375 (9.5)	1	250	R4310
TLS, BMP71*	Fig. 32	PTL-104-427	B-427	Vinyl	White	12 to 10	1.500 (38.1)	1.000 (25.4)	0.375 (9.5)	1	250	R4310
TLS, BMP71*	Fig. 32	PTL-87-427	B-427	Vinyl	White	12 to 10	1.750 (44.5)	1.000 (25.4)	0.375 (9.5)	1	250	R4310
TLS, BMP71*	Fig. 29	PTL-78-427-AW	B-427	Vinyl	White	All White	1.900 (48.3)	1.000 (25.4)	1.000 (25.4)	1	250	R4310
TLS, BMP71*	Fig. 32	PTL-102-427	B-427	Vinyl	White	10 to 4	0.500 (12.7)	1.250 (31.8)	0.375 (9.5)	1	250	R4310
TLS, BMP71*	Fig. 32	PTL-103-427	B-427	Vinyl	White	10 to 4	1.000 (25.4)	1.250 (31.8)	0.500 (12.7)	1	250	R4310
TLS, BMP71*	Fig. 32	PTL-28-427	B-427	Vinyl	White	10 to 4	0.250 (6.4)	1.500 (38.1)	0.500 (12.7)	1	750	R4310
TLS, BMP71*	Fig. 32	BM71-29-427	B-427	Vinyl	White	10 to 4	0.500 (12.7)	1.500 (38.1)	0.500 (12.7)	1	5000	R4310
TLS, BMP71*	Fig. 32	PTL-29-427	B-427	Vinyl	White	10 to 4	0.500 (12.7)	1.500 (38.1)	0.500 (12.7)	1	500	R4310
TLS, BMP71*	Fig. 32	BM71-30-427	B-427	Vinyl	White	10 to 4	0.750 (19.1)	1.500 (38.1)	0.500 (12.7)	1	2500	R4310
TLS, BMP71*	Fig. 32	PTL-30-427	B-427	Vinyl	White	10 to 4	0.750 (19.1)	1.500 (38.1)	0.500 (12.7)	1	250	R4310
TLS, BMP71*	Fig. 32	PTL-31-427	B-427	Vinyl	White	10 to 4	1.000 (25.4)	1.500 (38.1)	0.500 (12.7)	1	250	R4310
TLS, BMP71*	Fig. 32	BM71-31-427	B-427	Vinyl	White	10 to 4	1.000 (25.4)	1.500 (38.1)	0.500 (12.7)	1	2500	R4310
TLS, BMP71*	Fig. 32	PTL-31-642	B-427	Vinyl	White	10 to 4	1.000 (25.4)	1.500 (38.1)	0.500 (12.7)	1	250	R4310
TLS, BMP71*	Fig. 32	BM71-32-427	B-427	Vinyl	White	10 to 4	1.500 (38.1)	1.500 (38.1)	0.500 (12.7)	1	1000	R4310
TLS, BMP71*	Fig. 32	PTL-32-427	B-427	Vinyl	White	10 to 4	1.500 (38.1)	1.500 (38.1)	0.500 (12.7)	1	250	R4310
TLS, BMP71*	Fig. 32	PTL-88-427	B-427	Vinyl	White	10 to 4	1.750 (44.5)	1.500 (38.1)	0.500 (12.7)	1	250	R4310
TLS, BMP71*	Fig. 32	BM71-107-427	B-427	Vinyl	White	10 to 4	2.000 (50.8)	1.500 (38.1)	0.500 (12.7)	1	1000	R4310
TLS, BMP71*	Fig. 32	PTL-107-427	B-427	Vinyl	White	10 to 4	2.000 (50.8)	1.500 (38.1)	0.500 (12.7)	1	100	R4310
TLS, BMP71*	Fig. 27	PTL-74-427	B-427	Vinyl	White	Cables	0.500 (12.7)	2.200 (55.8)	0.750 (19.1)	1	100	R4310
TLS, BMP71*	Fig. 32	PTL-21-427	B-427	Vinyl	White	Cables	1.000 (25.4)	2.500 (63.5)	0.750 (19.1)	1	100	R4310
TLS, BMP71*	Fig. 32	BM71-21-427	B-427	Vinyl	White	Cables	1.000 (25.4)	2.500 (63.5)	0.750 (19.1)	1	1000	R4310
TLS, BMP71*	Fig. 32	PTL-21-642	B-427	Vinyl	White	Cables	1.000 (25.4)	2.500 (63.5)	0.750 (19.1)	1	100	R4310
TLS, BMP71*	Fig. 32	PTL-157-427	B-427	Vinyl	White	Cables	1.500 (38.1)	2.500 (63.5)	0.750 (19.1)	1	100	R4310
TLS, BMP71*	Fig. 42	PTL-75-427	B-427	Vinyl	White	Cables	1.000 (25.4)	2.625 (66.7)	1.000 (25.4)	1	100	R4310
TLS, BMP71*	Fig. 32	PTL-66-427	B-427	Vinyl	White	Cables	1.938 (49.2)	3.150 (80.0)	1.000 (25.4)	1	100	R4310
TLS, BMP71*	Fig. 32	PTL-77-461	B-427	Vinyl	White	Cables	1.500 (38.1)	3.500 (88.9)	1.250 (31.8)	1	100	R4310
TLS, BMP71*	Fig. 43	PTL-64-427	B-427	Vinyl	White	Cables	1.000 (25.4)	3.375 (85.7)	1.125 (28.6)	1	100	R4310
TLS, BMP71*	Fig. 43	BM71-64-427	B-427	Vinyl	White	Cables	1.000 (25.4)	3.375 (85.7)	1.125 (28.6)	1	1000	R4310
TLS, BMP71*	Fig. 32	PTL-23-427	B-427	Vinyl	White	Cables	1.000 (25.4)	4.000 (101.6)	1.000 (25.4)	1	100	R4310
TLS, BMP71*	Fig. 32	BM71-23-427	B-427	Vinyl	White	Cables	1.000 (25.4)	4.000 (101.6)	1.000 (25.4)	1	1000	R4310
TLS, BMP71*	Fig. 32	PTL-33-427	B-427	Vinyl	White	Cables	1.500 (38.1)	4.000 (101.6)	1.000 (25.4)	1	100	R4310
TLS, BMP71*	Fig. 32	BM71-33-427	B-427	Vinyl	White	Cables	1.500 (38.1)	4.000 (101.6)	1.000 (25.4)	1	500	R4310
TLS, BMP71*	Fig. 32	BM71-109-427	B-427	Vinyl	White	Cables	1.500 (38.1)	4.000 (101.6)	1.500 (38.1)	1	500	R4310
TLS, BMP71*	Fig. 56	PTL-109-427	B-427	Vinyl	White	Cables	1.500 (38.1)	4.000 (101.6)	1.500 (38.1)	1	100	R4310
TLS, BMP71*	Fig. 32	PTL-34-427	B-427	Vinyl	White	Cables	1.500 (38.1)	6.000 (152.4)	1.500 (38.1)	1	50	R4310
TLS, BMP71*	Fig. 32	BM71-34-427	B-427	Vinyl	White	Cables	1.500 (38.1)	6.000 (152.4)	1.500 (38.1)	1	500	R4310

B-427 Self-Laminating Vinyl Labels continue on next page.



### Finding the correct label height for your Self Laminating labels.

If you know your wire diameter or wire circumference, you can easily determine the correct label height by using the formula below.

**Step 1:** wire diameter x 3.147 (pi) = wire circumference

**Step 2:** wire circumference x 1.5 (allowing label to wrap 1.5 times around wire) = total label length

See all TLS2200® and PC Link™ Ribbon parts on page 323.

\* Yellow media adaptor required for use in the BMP®71 printer. See page 324.

\*Approx. wire gauge based on AWG for THHN wire.



## Self-Laminating Vinyl Wire & Cable Labels (B-427)

Continued from previous page.

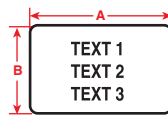

Figure 29

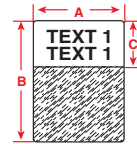

Figure 32

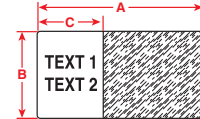

Figure 27

Fits Printer Models	Diagram	Part Number	B-#	Material	Color	Approx. Wire Gauge*	Label Width A Inch (mm)	Label Height B Inch (mm)	Print-On Height C Inch (mm)	Labels Per Row	Labels Per Roll	Rec. Ribbon
TLS, BMP71*	Fig. 32	PTL-10-427-YL	B-427	Vinyl	Yellow	16 to 10	0.250 (6.4)	0.750 (19.1)	0.375 (9.5)	1	750	R4310
TLS, BMP71*	Fig. 32	PTL-11-427-YL	B-427	Vinyl	Yellow	16 to 10	0.500 (12.7)	0.750 (19.1)	0.375 (9.5)	1	500	R4310
TLS, BMP71*	Fig. 32	PTL-17-427-YL	B-427	Vinyl	Yellow	12 to 10	0.500 (12.7)	1.000 (25.4)	0.375 (9.5)	1	500	R4310
TLS, BMP71*	Fig. 32	PTL-18-427-YL	B-427	Vinyl	Yellow	10 to 4	0.750 (19.1)	1.000 (25.4)	0.375 (9.5)	1	250	R4310
TLS, BMP71*	Fig. 32	PTL-19-427-YL	B-427	Vinyl	Yellow	12 to 10	1.000 (25.4)	1.000 (25.4)	0.375 (9.5)	1	250	R4310
TLS, BMP71*	Fig. 32	PTL-28-427-YL	B-427	Vinyl	Yellow	10 to 4	0.250 (6.4)	1.500 (38.1)	0.500 (12.7)	1	750	R4310
TLS, BMP71*	Fig. 32	PTL-29-427-YL	B-427	Vinyl	Yellow	10 to 4	0.500 (12.7)	1.500 (38.1)	0.500 (12.7)	1	500	R4310
TLS, BMP71*	Fig. 32	PTL-30-427-YL	B-427	Vinyl	Yellow	10 to 4	0.750 (19.1)	1.500 (38.1)	0.500 (12.7)	1	250	R4310
TLS, BMP71*	Fig. 32	PTL-31-427-YL	B-427	Vinyl	Yellow	10 to 4	1.000 (25.4)	1.500 (38.1)	0.500 (12.7)	1	250	R4310
TLS, BMP71*	Fig. 32	PTL-32-427-YL	B-427	Vinyl	Yellow	10 to 4	1.500 (38.1)	1.500 (38.1)	0.500 (12.7)	1	250	R4310
TLS, BMP71*	Fig. 32	PTL-21-427-YL	B-427	Vinyl	Yellow	Cables	1.000 (25.4)	2.500 (63.5)	0.750 (19.1)	1	100	R4310
TLS, BMP71*	Fig. 32	PTL-23-427-YL	B-427	Vinyl	Yellow	Cables	1.000 (25.4)	4.000 (101.6)	1.000 (25.4)	1	100	R4310
TLS, BMP71*	Fig. 32	PTL-33-427-YL	B-427	Vinyl	Yellow	Cables	1.500 (38.1)	4.000 (101.6)	1.000 (25.4)	1	100	R4310
TLS, BMP71*	Fig. 32	PTL-34-427-YL	B-427	Vinyl	Yellow	Cables	1.500 (38.1)	6.000 (152.4)	1.500 (38.1)	1	50	R4310
TLS, BMP71*	Fig. 32	PTL-19-427-BL	B-427	Vinyl	Blue	12 to 10	1.000 (25.4)	1.000 (25.4)	0.375 (9.5)	1	250	R4310
TLS, BMP71*	Fig. 32	PTL-28-427-BL	B-427	Vinyl	Blue	10 to 4	0.250 (6.4)	1.500 (38.1)	0.500 (12.7)	1	750	R4310
TLS, BMP71*	Fig. 32	PTL-29-427-BL	B-427	Vinyl	Blue	10 to 4	0.500 (12.7)	1.500 (38.1)	0.500 (12.7)	1	500	R4310
TLS, BMP71*	Fig. 32	PTL-30-427-BL	B-427	Vinyl	Blue	10 to 4	0.750 (19.1)	1.500 (38.1)	0.500 (12.7)	1	250	R4310
TLS, BMP71*	Fig. 32	PTL-31-427-BL	B-427	Vinyl	Blue	10 to 4	1.000 (25.4)	1.500 (38.1)	0.500 (12.7)	1	250	R4310
TLS, BMP71*	Fig. 32	PTL-32-427-BL	B-427	Vinyl	Blue	10 to 4	1.500 (38.1)	1.500 (38.1)	0.500 (12.7)	1	250	R4310
TLS, BMP71*	Fig. 32	PTL-21-427-BL	B-427	Vinyl	Blue	Cables	1.000 (25.4)	2.500 (63.5)	0.750 (19.1)	1	100	R4310
TLS, BMP71*	Fig. 32	PTL-23-427-BL	B-427	Vinyl	Blue	Cables	1.000 (25.4)	4.000 (101.6)	1.000 (25.4)	1	100	R4310
TLS, BMP71*	Fig. 32	PTL-33-427-BL	B-427	Vinyl	Blue	Cables	1.500 (38.1)	4.000 (101.6)	1.000 (25.4)	1	100	R4310
TLS, BMP71*	Fig. 32	PTL-34-427-BL	B-427	Vinyl	Blue	Cables	1.500 (38.1)	6.000 (152.4)	1.500 (38.1)	1	50	R4310
TLS, BMP71*	Fig. 32	PTL-19-427-BR	B-427	Vinyl	Brown	12 to 10	1.000 (25.4)	1.000 (25.4)	0.375 (9.5)	1	250	R4310
TLS, BMP71*	Fig. 32	PTL-28-427-BR	B-427	Vinyl	Brown	10 to 4	0.250 (6.4)	1.500 (38.1)	0.500 (12.7)	1	750	R4310
TLS, BMP71*	Fig. 32	PTL-29-427-BR	B-427	Vinyl	Brown	10 to 4	0.500 (12.7)	1.500 (38.1)	0.500 (12.7)	1	500	R4310
TLS, BMP71*	Fig. 32	PTL-30-427-BR	B-427	Vinyl	Brown	10 to 4	0.750 (19.1)	1.500 (38.1)	0.500 (12.7)	1	250	R4310
TLS, BMP71*	Fig. 32	PTL-31-427-BR	B-427	Vinyl	Brown	10 to 4	1.000 (25.4)	1.500 (38.1)	0.500 (12.7)	1	250	R4310
TLS, BMP71*	Fig. 32	PTL-32-427-BR	B-427	Vinyl	Brown	10 to 4	1.500 (38.1)	1.500 (38.1)	0.500 (12.7)	1	250	R4310
TLS, BMP71*	Fig. 32	PTL-21-427-BR	B-427	Vinyl	Brown	Cables	1.000 (25.4)	2.500 (63.5)	0.750 (19.1)	1	100	R4310
TLS, BMP71*	Fig. 32	PTL-23-427-BR	B-427	Vinyl	Brown	Cables	1.000 (25.4)	4.000 (101.6)	1.000 (25.4)	1	100	R4310
TLS, BMP71*	Fig. 32	PTL-33-427-BR	B-427	Vinyl	Brown	Cables	1.500 (38.1)	4.000 (101.6)	1.000 (25.4)	1	100	R4310
TLS, BMP71*	Fig. 32	PTL-34-427-BR	B-427	Vinyl	Brown	Cables	1.500 (38.1)	6.000 (152.4)	1.500 (38.1)	1	50	R4310
TLS, BMP71*	Fig. 32	PTL-19-427-GY	B-427	Vinyl	Gray	12 to 10	1.000 (25.4)	1.000 (25.4)	0.375 (9.5)	1	250	R4310
TLS, BMP71*	Fig. 32	PTL-28-427-GY	B-427	Vinyl	Gray	10 to 4	0.250 (6.4)	1.500 (38.1)	0.500 (12.7)	1	750	R4310
TLS, BMP71*	Fig. 32	PTL-29-427-GY	B-427	Vinyl	Gray	10 to 4	0.500 (12.7)	1.500 (38.1)	0.500 (12.7)	1	500	R4310
TLS, BMP71*	Fig. 32	PTL-30-427-GY	B-427	Vinyl	Gray	10 to 4	0.750 (19.1)	1.500 (38.1)	0.500 (12.7)	1	250	R4310
TLS, BMP71*	Fig. 32	PTL-31-427-GY	B-427	Vinyl	Gray	10 to 4	1.000 (25.4)	1.500 (38.1)	0.500 (12.7)	1	250	R4310
TLS, BMP71*	Fig. 32	PTL-32-427-GY	B-427	Vinyl	Gray	10 to 4	1.500 (38.1)	1.500 (38.1)	0.500 (12.7)	1	250	R4310
TLS, BMP71*	Fig. 32	PTL-21-427-GY	B-427	Vinyl	Gray	Cables	1.000 (25.4)	2.500 (63.5)	0.750 (19.1)	1	100	R4310
TLS, BMP71*	Fig. 32	PTL-23-427-GY	B-427	Vinyl	Gray	Cables	1.000 (25.4)	4.000 (101.6)	1.000 (25.4)	1	100	R4310
TLS, BMP71*	Fig. 32	PTL-33-427-GY	B-427	Vinyl	Gray	Cables	1.500 (38.1)	4.000 (101.6)	1.000 (25.4)	1	100	R4310
TLS, BMP71*	Fig. 32	PTL-34-427-GY	B-427	Vinyl	Gray	Cables	1.500 (38.1)	6.000 (152.4)	1.500 (38.1)	1	50	R4310
TLS, BMP71*	Fig. 32	PTL-19-427-GR	B-427	Vinyl	Green	12 to 10	1.000 (25.4)	1.000 (25.4)	0.375 (9.5)	1	250	R4310
TLS, BMP71*	Fig. 32	PTL-28-427-GR	B-427	Vinyl	Green	10 to 4	0.250 (6.4)	1.500 (38.1)	0.500 (12.7)	1	750	R4310
TLS, BMP71*	Fig. 32	PTL-29-427-GR	B-427	Vinyl	Green	10 to 4	0.500 (12.7)	1.500 (38.1)	0.500 (12.7)	1	500	R4310
TLS, BMP71*	Fig. 32	PTL-30-427-GR	B-427	Vinyl	Green	10 to 4	0.750 (19.1)	1.500 (38.1)	0.500 (12.7)	1	250	R4310
TLS, BMP71*	Fig. 32	PTL-31-427-GR	B-427	Vinyl	Green	10 to 4	1.000 (25.4)	1.500 (38.1)	0.500 (12.7)	1	250	R4310
TLS, BMP71*	Fig. 32	PTL-32-427-GR	B-427	Vinyl	Green	10 to 4	1.500 (38.1)	1.500 (38.1)	0.500 (12.7)	1	250	R4310
TLS, BMP71*	Fig. 32	PTL-21-427-GR	B-427	Vinyl	Green	Cables	1.000 (25.4)	2.500 (63.5)	0.750 (19.1)	1	100	R4310
TLS, BMP71*	Fig. 32	PTL-23-427-GR	B-427	Vinyl	Green	Cables	1.000 (25.4)	4.000 (101.6)	1.000 (25.4)	1	100	R4310
TLS, BMP71*	Fig. 32	PTL-33-427-GR	B-427	Vinyl	Green	Cables	1.500 (38.1)	4.000 (101.6)	1.000 (25.4)	1	100	R4310
TLS, BMP71*	Fig. 32	PTL-34-427-GR	B-427	Vinyl	Green	Cables	1.500 (38.1)	6.000 (152.4)	1.500 (38.1)	1	50	R4310

B-427 Self-Laminating Vinyl Labels continue on next page.

\*Approx. wire gauge based on AWG for THHN wire.

See all TLS2200® and PC Link™ Ribbon parts on page 323.  
\* Yellow media adaptor required for use in the BMP®71 printer. See page 324.



## Self-Laminating Vinyl Wire & Cable Labels (B-427)

Continued from previous page.

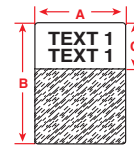

Figure 32

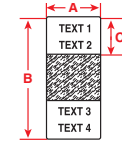

Figure 43  
(For Flagging)

Fits Printer Models	Diagram	Part Number	B-#	Material	Color	Approx. Wire Gauge*	Label Width A Inch (mm)	Label Height B Inch (mm)	Print-On Height C Inch (mm)	Labels Per Row	Labels Per Roll	Rec. Ribbon
TLS, BMP71*	Fig. 32	PTL-19-427-OR	B-427	Vinyl	Orange	12 to 10	1.000 (25.4)	1.000 (25.4)	0.375 (9.5)	1	250	R4310
TLS, BMP71*	Fig. 32	PTL-28-427-OR	B-427	Vinyl	Orange	10 to 4	0.250 (6.4)	1.500 (38.1)	0.500 (12.7)	1	750	R4310
TLS, BMP71*	Fig. 32	PTL-29-427-OR	B-427	Vinyl	Orange	10 to 4	0.500 (12.7)	1.500 (38.1)	0.500 (12.7)	1	500	R4310
TLS, BMP71*	Fig. 32	PTL-30-427-OR	B-427	Vinyl	Orange	10 to 4	0.750 (19.1)	1.500 (38.1)	0.500 (12.7)	1	250	R4310
TLS, BMP71*	Fig. 32	PTL-31-427-OR	B-427	Vinyl	Orange	10 to 4	1.000 (25.4)	1.500 (38.1)	0.500 (12.7)	1	250	R4310
TLS, BMP71*	Fig. 32	PTL-32-427-OR	B-427	Vinyl	Orange	10 to 4	1.500 (38.1)	1.500 (38.1)	0.500 (12.7)	1	250	R4310
TLS, BMP71*	Fig. 32	PTL-21-427-OR	B-427	Vinyl	Orange	Cables	1.000 (25.4)	2.500 (63.5)	0.750 (19.1)	1	100	R4310
TLS, BMP71*	Fig. 32	PTL-23-427-OR	B-427	Vinyl	Orange	Cables	1.000 (25.4)	4.000 (101.6)	1.000 (25.4)	1	100	R4310
TLS, BMP71*	Fig. 32	PTL-33-427-OR	B-427	Vinyl	Orange	Cables	1.500 (38.1)	4.000 (101.6)	1.000 (25.4)	1	100	R4310
TLS, BMP71*	Fig. 32	PTL-34-427-OR	B-427	Vinyl	Orange	Cables	1.500 (38.1)	6.000 (152.4)	1.500 (38.1)	1	50	R4310
TLS, BMP71*	Fig. 32	PTL-19-427-PL	B-427	Vinyl	Purple	12 to 10	1.000 (25.4)	1.000 (25.4)	0.375 (9.5)	1	250	R4310
TLS, BMP71*	Fig. 32	PTL-28-427-PL	B-427	Vinyl	Purple	10 to 4	0.250 (6.4)	1.500 (38.1)	0.500 (12.7)	1	750	R4310
TLS, BMP71*	Fig. 32	PTL-29-427-PL	B-427	Vinyl	Purple	10 to 4	0.500 (12.7)	1.500 (38.1)	0.500 (12.7)	1	500	R4310
TLS, BMP71*	Fig. 32	PTL-30-427-PL	B-427	Vinyl	Purple	10 to 4	0.750 (19.1)	1.500 (38.1)	0.500 (12.7)	1	250	R4310
TLS, BMP71*	Fig. 32	PTL-31-427-PL	B-427	Vinyl	Purple	10 to 4	1.000 (25.4)	1.500 (38.1)	0.500 (12.7)	1	250	R4310
TLS, BMP71*	Fig. 32	PTL-32-427-PL	B-427	Vinyl	Purple	10 to 4	1.500 (38.1)	1.500 (38.1)	0.500 (12.7)	1	250	R4310
TLS, BMP71*	Fig. 32	PTL-21-427-PL	B-427	Vinyl	Purple	Cables	1.000 (25.4)	2.500 (63.5)	0.750 (19.1)	1	100	R4310
TLS, BMP71*	Fig. 32	PTL-23-427-PL	B-427	Vinyl	Purple	Cables	1.000 (25.4)	4.000 (101.6)	1.000 (25.4)	1	100	R4310
TLS, BMP71*	Fig. 32	PTL-33-427-PL	B-427	Vinyl	Purple	Cables	1.500 (38.1)	4.000 (101.6)	1.000 (25.4)	1	100	R4310
TLS, BMP71*	Fig. 32	PTL-34-427-PL	B-427	Vinyl	Purple	Cables	1.500 (38.1)	6.000 (152.4)	1.500 (38.1)	1	50	R4310
TLS, BMP71*	Fig. 32	PTL-19-427-RD	B-427	Vinyl	Red	12 to 10	1.000 (25.4)	1.000 (25.4)	0.375 (9.5)	1	250	R4310
TLS, BMP71*	Fig. 32	PTL-28-427-RD	B-427	Vinyl	Red	10 to 4	0.250 (6.4)	1.500 (38.1)	0.500 (12.7)	1	750	R4310
TLS, BMP71*	Fig. 32	PTL-29-427-RD	B-427	Vinyl	Red	10 to 4	0.500 (12.7)	1.500 (38.1)	0.500 (12.7)	1	500	R4310
TLS, BMP71*	Fig. 32	PTL-30-427-RD	B-427	Vinyl	Red	10 to 4	0.750 (19.1)	1.500 (38.1)	0.500 (12.7)	1	250	R4310
TLS, BMP71*	Fig. 32	PTL-31-427-RD	B-427	Vinyl	Red	10 to 4	1.000 (25.4)	1.500 (38.1)	0.500 (12.7)	1	250	R4310
TLS, BMP71*	Fig. 32	PTL-32-427-RD	B-427	Vinyl	Red	10 to 4	1.500 (38.1)	1.500 (38.1)	0.500 (12.7)	1	250	R4310
TLS, BMP71*	Fig. 32	PTL-21-427-RD	B-427	Vinyl	Red	Cables	1.000 (25.4)	2.500 (63.5)	0.750 (19.1)	1	100	R4310
TLS, BMP71*	Fig. 32	PTL-23-427-RD	B-427	Vinyl	Red	Cables	1.000 (25.4)	4.000 (101.6)	1.000 (25.4)	1	100	R4310
TLS, BMP71*	Fig. 32	PTL-33-427-RD	B-427	Vinyl	Red	Cables	1.500 (38.1)	4.000 (101.6)	1.000 (25.4)	1	100	R4310
TLS, BMP71*	Fig. 32	PTL-34-427-RD	B-427	Vinyl	Red	Cables	1.500 (38.1)	6.000 (152.4)	1.500 (38.1)	1	50	R4310



### Finding the correct label height for your Self Laminating labels.

If you know your wire diameter or wire circumference, you can easily determine the correct label height by using the formula below.

**Step 1:** 
$$\frac{\text{wire dia.} \times 3.147 (\pi)}{\text{wire circumference}}$$

**Step 2:** 
$$\frac{\text{wire circumference} \times 1.5}{\text{total label length}}$$

(Multiplying by 1.5 allows the label to wrap 1.5 times around the wire)



See all TLS2200® and PC Link™ Ribbon parts on page 323.

\* Yellow media adaptor required for use in the BMP®71 printer. See page 324.

\*Approx. wire gauge based on AWG for THHN wire.



BradyID.com/tls2200

## PermaSleeve® PS Polyolefin Wire Marking Sleeves (B-342)

Single-sided, 3:1 shrink ratio, heat shrinkable sleeve fits snugly around wire for identification and protection. Fade resistant and flame retardant. Meets the following material and physical property specifications.

- SAE-AMS-DTL-23053/5C (Class 1)
- MIL-STD-202
- SAE-AS-81531
- RoHS Compliant
- UL Recognized
- Tested per:**
- ASTM E162
- ASTM E662

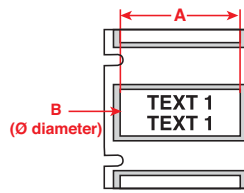

Figure 44



### \*Additional PermaSleeve Colors:

You may also choose to order your sleeves in the colors listed below. To order, replace the singular asterisk (\*) with the abbreviation of the desired color.

Example: PSPT-187-175-\* becomes PSPT-187-175-YL

**Available colors:** WT=White, YL=Yellow, BK=Black, BL=Blue, BR=Brown, GR=Green, GY=Gray, OR=Orange, PK=Pink, RD=Red, VT=Violet

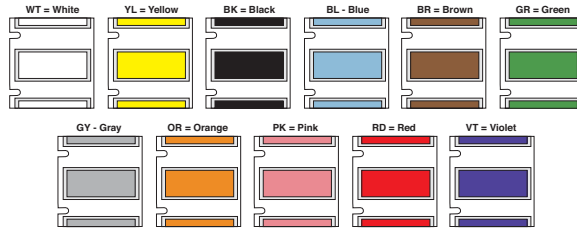

Fits Printer Models	Part Number	Approx. Wire Gauge	Range of Wire Diameter		Sleeve Width A Inch (mm)	Supplied Diameter B Inch (mm)	Recovered Diameter Inch (mm)	Recovered Wall Thickness Inch (mm)	Sleeves Per Row	Sleeves Per Roll	Rec. Ribbon
			Min.	Max.							
TLS, BMP71*	PSPT-094-1-WT	28 to 20	0.023 (0.6)	- 0.080 (2.0)	1.015 (25.8)	0.094 (2.4)	0.024 (0.6)	.024 (0.6) ± .003 (0.07)	1	100	R4310
TLS, BMP71*	PSPT-094-1*	28 to 20	0.023 (0.6)	- 0.080 (2.0)	1.015 (25.8)	0.094 (2.4)	0.024 (0.6)	.024 (0.6) ± .003 (0.07)	1	100	R4310
TLS, BMP71*	PSPT-094-175-WT	28 to 20	0.023 (0.6)	- 0.080 (2.0)	1.765 (44.8)	0.094 (2.4)	0.024 (0.6)	.024 (0.6) ± .003 (0.07)	1	100	R4310
TLS, BMP71*	PSPT-094-175*	28 to 20	0.023 (0.6)	- 0.080 (2.0)	1.765 (44.8)	0.094 (2.4)	0.024 (0.6)	.024 (0.6) ± .003 (0.07)	1	100	R4310
TLS, BMP71*	BM71-094-1-WT	28 to 20	0.023 (0.6)	- 0.080 (2.0)	1.015 (25.8)	0.094 (2.4)	0.024 (0.6)	.024 (0.6) ± .003 (0.07)	1	2500	R4310
TLS, BMP71*	BM71-094-175-WT	28 to 20	0.023 (0.6)	- 0.080 (2.0)	1.765 (44.8)	0.094 (2.4)	0.024 (0.6)	.024 (0.6) ± .003 (0.07)	1	2500	R4310
TLS, BMP71*	PSPT-125-1-WT	22 to 16	0.046 (1.2)	- 0.110 (2.8)	1.015 (25.8)	0.125 (3.2)	0.047 (1.2)	.020 (0.5) ± .003 (0.07)	1	100	R4310
TLS, BMP71*	PSPT-125-1*	22 to 16	0.046 (1.2)	- 0.110 (2.8)	1.015 (25.8)	0.125 (3.2)	0.047 (1.2)	.020 (0.5) ± .003 (0.07)	1	100	R4310
TLS, BMP71*	PSPT-125-175-WT	22 to 16	0.046 (1.2)	- 0.110 (2.8)	1.765 (44.8)	0.125 (3.2)	0.047 (1.2)	.020 (0.5) ± .003 (0.07)	1	100	R4310
TLS, BMP71*	PSPT-125-175*	22 to 16	0.046 (1.2)	- 0.110 (2.8)	1.765 (44.8)	0.125 (3.2)	0.047 (1.2)	.020 (0.5) ± .003 (0.07)	1	100	R4310
TLS, BMP71*	BM71-125-1-WT	22 to 16	0.046 (1.2)	- 0.110 (2.8)	1.015 (25.8)	0.125 (3.2)	0.047 (1.2)	.020 (0.5) ± .003 (0.07)	1	1000	R4310
TLS, BMP71*	BM71-125-175-WT	22 to 16	0.046 (1.2)	- 0.110 (2.8)	1.765 (44.8)	0.125 (3.2)	0.047 (1.2)	.020 (0.5) ± .003 (0.07)	1	1000	R4310
TLS, BMP71*	PSPT-187-1-WT	20 to 10	0.062 (1.6)	- 0.150 (3.8)	1.015 (25.8)	0.187 (4.7)	0.062 (1.6)	.020 (0.5) ± .003 (0.07)	1	100	R4310
TLS, BMP71*	PSPT-187-1*	20 to 10	0.062 (1.6)	- 0.150 (3.8)	1.015 (25.8)	0.187 (4.7)	0.062 (1.6)	.020 (0.5) ± .003 (0.07)	1	100	R4310
TLS, BMP71*	PSPT-187-175-WT	20 to 10	0.062 (1.6)	- 0.150 (3.8)	1.765 (44.8)	0.187 (4.7)	0.062 (1.6)	.020 (0.5) ± .003 (0.07)	1	100	R4310
TLS, BMP71*	PSPT-187-175*	20 to 10	0.062 (1.6)	- 0.150 (3.8)	1.765 (44.8)	0.187 (4.7)	0.062 (1.6)	.020 (0.5) ± .003 (0.07)	1	100	R4310
TLS, BMP71*	BM71-187-1-WT	20 to 10	0.062 (1.6)	- 0.150 (3.8)	1.015 (25.8)	0.187 (4.7)	0.062 (1.6)	.020 (0.5) ± .003 (0.07)	1	1000	R4310
TLS, BMP71*	BM71-187-175-WT	20 to 10	0.062 (1.6)	- 0.150 (3.8)	1.765 (44.8)	0.187 (4.7)	0.062 (1.6)	.020 (0.5) ± .003 (0.07)	1	1000	R4310
TLS, BMP71*	PSPT-250-1-WT	16 to 8	0.094 (2.4)	- 0.215 (5.5)	1.015 (25.8)	0.250 (6.4)	0.093 (2.4)	.025 (0.6) ± .003 (0.07)	1	100	R4310
TLS, BMP71*	PSPT-250-1*	16 to 8	0.094 (2.4)	- 0.215 (5.5)	1.015 (25.8)	0.250 (6.4)	0.093 (2.4)	.025 (0.6) ± .003 (0.07)	1	100	R4310
TLS, BMP71*	PSPT-250-175-WT	16 to 8	0.094 (2.4)	- 0.215 (5.5)	1.765 (44.8)	0.250 (6.4)	0.093 (2.4)	.025 (0.6) ± .003 (0.07)	1	100	R4310
TLS, BMP71*	PSPT-250-175*	16 to 8	0.094 (2.4)	- 0.215 (5.5)	1.765 (44.8)	0.250 (6.4)	0.093 (2.4)	.025 (0.6) ± .003 (0.07)	1	100	R4310
TLS, BMP71*	BM71-250-1-WT	16 to 8	0.094 (2.4)	- 0.215 (5.5)	1.015 (25.8)	0.250 (6.4)	0.093 (2.4)	.025 (0.6) ± .003 (0.07)	1	1000	R4310
TLS, BMP71*	BM71-250-175-WT	16 to 8	0.094 (2.4)	- 0.215 (5.5)	1.765 (44.8)	0.250 (6.4)	0.093 (2.4)	.025 (0.6) ± .003 (0.07)	1	1000	R4310
TLS, BMP71*	PSPT-375-1-WT	12 to 4	0.125 (3.2)	- 0.320 (8.13)	1.015 (25.8)	0.375 (9.5)	0.125 (3.1)	.025 (0.6) ± .003 (0.07)	1	100	R4310
TLS, BMP71*	PSPT-375-1*	12 to 4	0.125 (3.2)	- 0.320 (8.13)	1.015 (25.8)	0.375 (9.5)	0.125 (3.1)	.025 (0.6) ± .003 (0.07)	1	100	R4310
TLS, BMP71*	PSPT-375-175-WT	12 to 4	0.125 (3.2)	- 0.320 (8.13)	1.765 (44.8)	0.375 (9.5)	0.125 (3.1)	.025 (0.6) ± .003 (0.07)	1	100	R4310
TLS, BMP71*	PSPT-375-175*	12 to 4	0.125 (3.2)	- 0.320 (8.13)	1.765 (44.8)	0.375 (9.5)	0.125 (3.1)	.025 (0.6) ± .003 (0.07)	1	100	R4310
TLS, BMP71*	BM71-375-1-WT	12 to 4	0.125 (3.2)	- 0.320 (8.13)	1.015 (25.8)	0.375 (9.5)	0.125 (3.1)	.025 (0.6) ± .003 (0.07)	1	1000	R4310
TLS, BMP71*	BM71-375-175-WT	12 to 4	0.125 (3.2)	- 0.320 (8.13)	1.765 (44.8)	0.375 (9.5)	0.125 (3.1)	.025 (0.6) ± .003 (0.07)	1	1000	R4310
TLS, BMP71*	PSPT-500-1-WT	8 to 1	0.187 (4.8)	- 0.450 (11.4)	1.015 (25.8)	0.500 (12.7)	0.187 (4.7)	.025 (0.6) ± .003 (0.07)	1	100	R4310
TLS, BMP71*	PSPT-500-1*	8 to 1	0.187 (4.8)	- 0.450 (11.4)	1.015 (25.8)	0.500 (12.7)	0.187 (4.7)	.025 (0.6) ± .003 (0.07)	1	100	R4310
TLS, BMP71*	PSPT-500-175-WT	8 to 1	0.187 (4.8)	- 0.450 (11.4)	1.765 (44.8)	0.500 (12.7)	0.187 (4.7)	.025 (0.6) ± .003 (0.07)	1	100	R4310
TLS, BMP71*	PSPT-500-175*	8 to 1	0.187 (4.8)	- 0.450 (11.4)	1.765 (44.8)	0.500 (12.7)	0.187 (4.7)	.025 (0.6) ± .003 (0.07)	1	100	R4310
TLS, BMP71*	BM71-500-1-WT	8 to 1	0.187 (4.8)	- 0.450 (11.4)	1.015 (25.8)	0.500 (12.7)	0.187 (4.7)	.025 (0.6) ± .003 (0.07)	1	1000	R4310
TLS, BMP71*	BM71-500-175-WT	8 to 1	0.187 (4.8)	- 0.450 (11.4)	1.765 (44.8)	0.500 (12.7)	0.187 (4.7)	.025 (0.6) ± .003 (0.07)	1	1000	R4310
TLS, BMP71*	PSPT-1000-1-WT	2 to 0.950 dia.	0.333 (8.5)	- 0.950 (24.1)	1.015 (25.8)	1.000 (25.4)	0.375 (9.5)	.036 (0.9) ± .003 (0.07)	1	50	R4310
TLS, BMP71*	PSPT-1000-1*	2 to 0.950 dia.	0.333 (8.5)	- 0.950 (24.1)	1.015 (25.8)	1.000 (25.4)	0.375 (9.5)	.036 (0.9) ± .003 (0.07)	1	50	R4310
TLS, BMP71*	PSPT-1000-175-WT	2 to 0.950 dia.	0.333 (8.5)	- 0.950 (24.1)	1.765 (44.8)	1.000 (25.4)	0.375 (9.5)	.036 (0.9) ± .003 (0.07)	1	50	R4310
TLS, BMP71*	PSPT-1000-175*	2 to 0.950 dia.	0.333 (8.5)	- 0.950 (24.1)	1.765 (44.8)	1.000 (25.4)	0.375 (9.5)	.036 (0.9) ± .003 (0.07)	1	50	R4310
TLS, BMP71*	BM71-1000-175-WT	2 to 0.950 dia.	0.333 (8.5)	- 0.950 (24.1)	1.765 (44.8)	1.000 (25.4)	0.375 (9.5)	.036 (0.9) ± .003 (0.07)	1	500	R4310

\*Approx. wire gauge based on AWG for THHN wire.

See all TLS2200® and PC Link™ Ribbon parts on page 323.

\* Yellow media adaptor required for use in the BMP®71 printer. See page 324.



## TLS 2200® & TLS PC Link™ Printer Ribbons

Note: Black Ribbon 3MA45 included with TLS 2200 printer purchase.  
Ribbons listed below for use in TLS 2200® and TLS PC Link™ printers only.  
They are **not** compatible with the BMP®71 printer

Part Number	Description	Size
R4310	Black Ribbon	75' (22.90 m)
R6010	Black Ribbon	75' (22.90 m)
R6210	Black Ribbon	75' (22.90 m)
R4410-BL	Blue Ribbon	75' (22.90 m)
R4410-RD	Red Ribbon	75' (22.90 m)
R4410-WT	White Ribbon	75' (22.90 m)

### TLS 2200® & TLS PC Link™ Print Ribbon / Material Compatibility

B-Number	Material	R4310 (Black)	R6010 (Black)	R6210 (Black)	R4410 (Colors)
B-109	Polyethylene	●	●	-	-
B-145	Polyethylene	-	-	●	-
B-321	Polyolefin	-	-	-	●
B-342	Polyolefin	●	-	-	-
B-351	Vinyl	-	-	-	●
B-352	Vinyl	-	-	●	-
B-390	Polypropylene	-	●	-	-
B-412	Polypropylene	-	-	-	●
B-422	Polyester	-	▲	● UL/CSA	▲
B-423	Polyester	-	▲	● UL/CSA/AGA	▲
B-424	Paper	●	-	-	-
B-425	Polypropylene	● UL	-	● UL/CSA	-
B-427	Vinyl	● UL	-	-	▲
B-428	Polyester	● UL/CSA/AGA	-	-	-
B-430	Polyester	-	▲	● UL/CSA	▲
B-432	Polyester	-	▲	● UL/CSA	-
B-435	Polyester	-	-	● UL/CSA	-
B-439	Vinyl	-	▲	●	▲
B-449	Polypropylene	●	-	●	-
B-459	Polyester	-	▲ UL	● UL/CSA	-
B-461	Polyester	●	-	-	▲
B-473	Polyester	-	-	● UL/CSA	▲
B-483	Polyester	-	▲	● UL/CSA	▲
B-486	Polyester	● UL/CSA	-	-	-
B-488	Polyester	● UL/CSA/AGA	-	-	● UL/CSA
B-489	Polyester	● UL/CSA	-	-	-
B-490	Polyester	●	-	▲	-
B-498	Vinyl Cloth	▲	-	-	●
B-499	Nylon Cloth	● UL/CSA	-	-	▲
B-593	Polyester	-	● UL/cUL	-	● UL/cUL
B-724	Polyimide	●	-	-	-
B-727	Polyimide	-	-	● UL	-
B-717	Polyimide	-	● UL	-	▲
B-718	Polyimide	-	-	● UL	-
B-719	Polyimide	-	-	● UL	-
B-7546	Polyester	-	-	● UL/CSA	-
B-7566	Polyester	-	▲	●	-
B-7576	Polyester	-	▲	● UL	-
B-8425	Polyolefin	-	▲	● UL	-

- Rec. Ribbon for use with respective material.
- ▲ Acceptable ribbon for use with respective material.
- UL These materials are UL recognized with its respective ribbon.

- cUL These materials have been evaluated to Canadian safety requirements.
- CSA These materials are approved with its respective ribbon.
- AGA These materials are AGA approved.

For more information on Brady materials, visit [BradyID.com/techdata](http://BradyID.com/techdata).



### How Many Labels Per Ribbon?

Have you ever wondered approximately how many labels you can print from one TLS 2200 Ribbon? Try this formula:  
(Note: Our standard TLS2200 ribbons are 900 inches long (75 ft).)

- Step 1:** label height + 0.10 = X  
**Step 2:** 900 inches ÷ X = total labels per ribbon

**Example:** Part Number PLT-19-422 is 1.0" tall.  
 1.0 inch label height + 0.10 = 1.10  
 900 inches ÷ 1.10 = 818 labels per ribbon



# BMP®71 Label Printer

BradyID.com/bmp71

Portable Printers



## BMP®71 LABEL PRINTER

**Thousands Of Applications. Hundreds Of Labels. One Label Printer.**

The most versatile portable printer in our offering. Painless setup, robust label offering and intuitive interface come together in our top-of-the-line portable printer.

### Text and Print Options:

- 100's Of Symbols
- Underline
- Reverse Print
- Italics/Bold
- Subscripts
- Serialization
- Auto Font Size
- Vertical Printing
- Barcodes
- And more!
- Time/Date Stamps

**Online Video!**  
Visit [BradyID.com/bmp71](http://BradyID.com/bmp71) for more information or to view an online printer demo video.

**Your Complete Printing Solution:**  
BMP®71 Label Rolls .....Page 325  
BMP®71 Print Ribbons.....Page 337

Catalog #	Description
BMP71	BMP71 Printer*
BMP71-LM	BMP71 Printer* w/ LabelMark™ Software
BMP71-MW	BMP71 Printer* w/ Markware Lean Software
BMP71-QC	BMP71 Printer* w/ Quick Charger
BMP71-SC	BMP71 Printer* w/ Soft Case
BMP71-SC-QC	BMP71 Printer* w/ Soft Case & Quick Charger
M71-AC-BC	BMP71 AC/Battery Adaptor
M71-ADAPT	TLS/HandiMark Media Adaptor
M71-BATT	BMP71 Battery Pack
M71-CABLE	BMP71 USB Cable
M71-CLEAN	BMP71 Cleaning Kit
M71-HC	BMP71 Hardcase
M71-QC	BMP71 Quick Charger
M71-SC	BMP71 Softcase

\*Printer ships with Hardcase, Charger/AC Adapter, (1) Roll of M71-31-423 White Die Cut Labels, (1) M71-R6000 Black Ribbon Cartridge, Media Adapter, Rechargeable Battery, USB Cable, Quickstart Guide, drivers CD, Users Guide, Tutorial and 1 year Limited Warranty.

U.S. Patent No. 7,999,836; 8,328,442; 8,333,524.



**Did You Know?**  
The BMP®71 printer can also print on TLS2200® and HandiMark® label rolls using the included Media Adaptor!  
\* BMP®71 printer requires its own print ribbons, see page 337.

BMP®71 Printer Specifications	
Max Labels Per Day	Average 1000 labels/day
Print Resolution	300 dpi
Print Technology	Thermal Transfer
Print Speed	38mm/sec (1.5"/sec)
Tape Widths (inches)	Various sizes from 0.235" to 2.00"
Tape Widths (mm)	Various sizes from 6.4 to 50.8 mm
Max Label Width	2.00" (50.8mm)
Max Print Width	1.92" (48.76 mm)
Memory	200 MB
Materials Supported	M71-, BM71-, BPTL- Series 450+ stock parts, plus TLS parts with adaptor
Cont. vs. Die Cut	Continuous and die cut
Connectivity	Yes
PC Connectivity	USB
Software Compatibility	LabelMark® / CodeSoft™ Software
Data Transfer from PC	Yes - with Labelmark® Software
Wireless Connectivity	No
Stand Alone Printing	Yes
Color Capability	Single print color on a label
Keyboard	QWERTY, AZERTY, QWERTZ, CYRILLIC
Backlit Screen	3.5", backlit
Text Sizes	4 to 174 pt + autosizing
Multi-Line Print	Yes
Print Rotation	Yes
Serialization	Yes, multiple and linked
Barcode	39 and 128
Symbols	500+
Portability	Yes

Label Types or Application Functions	
Polyester (Adhesive, Permanent, Metallized, Clear, Flame Retardant, Ultra Aggressive, & High Performance, Engraved Plate Substitute) Polyethylene Tag, Polyethylene, Block Vinyl, Permasleeve® Heat Shrinking, Polypropylene Tag, Polyimide, Vinyl (Tamper-Evident, Destructible, Repositional, Self Laminating, Indoor/Outdoor) Polyimide, Repositionable Vinyl Cloth, Nylon Cloth, Polypropylene Tape, Phosphorescent, Reflective, Tedlar, ToughWash, ToughWash Metal Detectable	
Applications	
Circuit Board Labeling, Data Communications Labeling, Facility, Safety & Maintenance Identification, General & Industrial Labeling, Panel Identification, Security Identification, Wire & Cable Marking, Pipe Marking	
Power Supply	Rechargeable NiMH battery, AC Power/battery charger
Weight	5.429 lbs (2.47 kg)
Warranty	1 year

**The one way to faster, easier label printing.**

Electrical Labeling

Voice & Data Communications

General Identification

PermaSleeve® Wire Marking Sleeves

Self-Laminating Labels

Safety Labels  
...and many more!

## Vinyl for Safety, Facility & Lean 5S ID (B-595)

### • B-595 Indoor/Outdoor Vinyl Material

Aggressive permanent adhesive, very pliable, conforms to rough surfaces, excellent resistance to oils, detergents, dirt, and many solvents. 8-10 year average outdoor durability.



Figure 33



Diagram	Catalog #	B#	Material	Color	Label Width A Inch (mm)	Roll Length B Inch (mm)	Labels Per Roll	Rec. Ribbon
<b>B-595 Indoor/Outdoor Vinyl Film</b>								
Fig. 33	M71C-500-595-WT	B-595	Vinyl	White	0.500 (12.7)	50 ft. (15.2 m)	1 Roll (cont.)	M71-R6000
Fig. 33	M71C-1000-595-WT	B-595	Vinyl	White	1.000 (25.4)	50 ft. (15.2 m)	1 Roll (cont.)	M71-R6000
Fig. 33	M71C-2000-595-WT	B-595	Vinyl	White	2.000 (50.8)	50 ft. (15.2 m)	1 Roll (cont.)	M71-R6000
Fig. 33	M71C-500-595-YL	B-595	Vinyl	Yellow	0.500 (12.7)	50 ft. (15.2 m)	1 Roll (cont.)	M71-R6000
Fig. 33	M71C-1000-595-YL	B-595	Vinyl	Yellow	1.000 (25.4)	50 ft. (15.2 m)	1 Roll (cont.)	M71-R6000
Fig. 33	M71C-2000-595-YL	B-595	Vinyl	Yellow	2.000 (50.8)	50 ft. (15.2 m)	1 Roll (cont.)	M71-R6000
Fig. 33	M71C-500-595-BK	B-595	Vinyl	Black	0.500 (12.7)	50 ft. (15.2 m)	1 Roll (cont.)	M71-R4400-WT
Fig. 33	M71C-1000-595-BK	B-595	Vinyl	Black	1.000 (25.4)	50 ft. (15.2 m)	1 Roll (cont.)	M71-R4400-WT
Fig. 33	M71C-2000-595-BK	B-595	Vinyl	Black	2.000 (50.8)	50 ft. (15.2 m)	1 Roll (cont.)	M71-R4400-WT
Fig. 33	M71C-500-595-BL	B-595	Vinyl	Blue	0.500 (12.7)	50 ft. (15.2 m)	1 Roll (cont.)	M71-R4400-WT
Fig. 33	M71C-1000-595-BL	B-595	Vinyl	Blue	1.000 (25.4)	50 ft. (15.2 m)	1 Roll (cont.)	M71-R4400-WT
Fig. 33	M71C-2000-595-BL	B-595	Vinyl	Blue	2.000 (50.8)	50 ft. (15.2 m)	1 Roll (cont.)	M71-R4400-WT
Fig. 33	M71C-500-595-BR	B-595	Vinyl	Brown	0.500 (12.7)	50 ft. (15.2 m)	1 Roll (cont.)	M71-R6000
Fig. 33	M71C-1000-595-BR	B-595	Vinyl	Brown	1.000 (25.4)	50 ft. (15.2 m)	1 Roll (cont.)	M71-R6000
Fig. 33	M71C-2000-595-BR	B-595	Vinyl	Brown	2.000 (50.8)	50 ft. (15.2 m)	1 Roll (cont.)	M71-R6000
Fig. 33	M71C-500-595-CL	B-595	Vinyl	Clear	0.500 (12.7)	50 ft. (15.2 m)	1 Roll (cont.)	M71-R6000
Fig. 33	M71C-1000-595-CL	B-595	Vinyl	Clear	1.000 (25.4)	50 ft. (15.2 m)	1 Roll (cont.)	M71-R6000
Fig. 33	M71C-2000-595-CL	B-595	Vinyl	Clear	2.000 (50.8)	50 ft. (15.2 m)	1 Roll (cont.)	M71-R6000
Fig. 33	M71C-500-595-GD	B-595	Vinyl	Gold	0.500 (12.7)	50 ft. (15.2 m)	1 Roll (cont.)	M71-R6000
Fig. 33	M71C-1000-595-GD	B-595	Vinyl	Gold	1.000 (25.4)	50 ft. (15.2 m)	1 Roll (cont.)	M71-R6000
Fig. 33	M71C-2000-595-GD	B-595	Vinyl	Gold	2.000 (50.8)	50 ft. (15.2 m)	1 Roll (cont.)	M71-R6000
Fig. 33	M71C-500-595-GN	B-595	Vinyl	Green	0.500 (12.7)	50 ft. (15.2 m)	1 Roll (cont.)	M71-R4400-WT
Fig. 33	M71C-1000-595-GN	B-595	Vinyl	Green	1.000 (25.4)	50 ft. (15.2 m)	1 Roll (cont.)	M71-R4400-WT
Fig. 33	M71C-2000-595-GN	B-595	Vinyl	Green	2.000 (50.8)	50 ft. (15.2 m)	1 Roll (cont.)	M71-R4400-WT
Fig. 33	M71C-500-595-GY	B-595	Vinyl	Gray	0.500 (12.7)	50 ft. (15.2 m)	1 Roll (cont.)	M71-R6000
Fig. 33	M71C-1000-595-GY	B-595	Vinyl	Gray	1.000 (25.4)	50 ft. (15.2 m)	1 Roll (cont.)	M71-R6000
Fig. 33	M71C-2000-595-GY	B-595	Vinyl	Gray	2.000 (50.8)	50 ft. (15.2 m)	1 Roll (cont.)	M71-R6000
Fig. 33	M71C-500-595-LB	B-595	Vinyl	Light Blue	0.500 (12.7)	50 ft. (15.2 m)	1 Roll (cont.)	M71-R6000
Fig. 33	M71C-1000-595-LB	B-595	Vinyl	Light Blue	1.000 (25.4)	50 ft. (15.2 m)	1 Roll (cont.)	M71-R6000
Fig. 33	M71C-2000-595-LB	B-595	Vinyl	Light Blue	2.000 (50.8)	50 ft. (15.2 m)	1 Roll (cont.)	M71-R6000
Fig. 33	M71C-500-595-OC	B-595	Vinyl	Ochre	0.500 (12.7)	50 ft. (15.2 m)	1 Roll (cont.)	M71-R6000
Fig. 33	M71C-1000-595-OC	B-595	Vinyl	Ochre	1.000 (25.4)	50 ft. (15.2 m)	1 Roll (cont.)	M71-R6000
Fig. 33	M71C-2000-595-OC	B-595	Vinyl	Ochre	2.000 (50.8)	50 ft. (15.2 m)	1 Roll (cont.)	M71-R6000
Fig. 33	M71C-500-595-OR	B-595	Vinyl	Orange	0.500 (12.7)	50 ft. (15.2 m)	1 Roll (cont.)	M71-R6000
Fig. 33	M71C-1000-595-OR	B-595	Vinyl	Orange	1.000 (25.4)	50 ft. (15.2 m)	1 Roll (cont.)	M71-R6000
Fig. 33	M71C-2000-595-OR	B-595	Vinyl	Orange	2.000 (50.8)	50 ft. (15.2 m)	1 Roll (cont.)	M71-R6000
Fig. 33	M71C-500-595-PK	B-595	Vinyl	Pink	0.500 (12.7)	50 ft. (15.2 m)	1 Roll (cont.)	M71-R6000
Fig. 33	M71C-1000-595-PK	B-595	Vinyl	Pink	1.000 (25.4)	50 ft. (15.2 m)	1 Roll (cont.)	M71-R6000
Fig. 33	M71C-2000-595-PK	B-595	Vinyl	Pink	2.000 (50.8)	50 ft. (15.2 m)	1 Roll (cont.)	M71-R6000
Fig. 33	M71C-500-595-PL	B-595	Vinyl	Purple	0.500 (12.7)	50 ft. (15.2 m)	1 Roll (cont.)	M71-R6000
Fig. 33	M71C-1000-595-PL	B-595	Vinyl	Purple	1.000 (25.4)	50 ft. (15.2 m)	1 Roll (cont.)	M71-R6000
Fig. 33	M71C-2000-595-PL	B-595	Vinyl	Purple	2.000 (50.8)	50 ft. (15.2 m)	1 Roll (cont.)	M71-R6000
Fig. 33	M71C-500-595-RD	B-595	Vinyl	Red	0.500 (12.7)	50 ft. (15.2 m)	1 Roll (cont.)	M71-R4400-WT
Fig. 33	M71C-1000-595-RD	B-595	Vinyl	Red	1.000 (25.4)	50 ft. (15.2 m)	1 Roll (cont.)	M71-R4400-WT
Fig. 33	M71C-2000-595-RD	B-595	Vinyl	Red	2.000 (50.8)	50 ft. (15.2 m)	1 Roll (cont.)	M71-R4400-WT
Fig. 33	M71C-500-595-SB	B-595	Vinyl	Sky Blue	0.500 (12.7)	50 ft. (15.2 m)	1 Roll (cont.)	M71-R6000
Fig. 33	M71C-1000-595-SB	B-595	Vinyl	Sky Blue	1.000 (25.4)	50 ft. (15.2 m)	1 Roll (cont.)	M71-R6000
Fig. 33	M71C-2000-595-SB	B-595	Vinyl	Sky Blue	2.000 (50.8)	50 ft. (15.2 m)	1 Roll (cont.)	M71-R6000
Fig. 33	M71C-500-595-TN	B-595	Vinyl	Tan	0.500 (12.7)	50 ft. (15.2 m)	1 Roll (cont.)	M71-R6000
Fig. 33	M71C-1000-595-TN	B-595	Vinyl	Tan	1.000 (25.4)	50 ft. (15.2 m)	1 Roll (cont.)	M71-R6000
Fig. 33	M71C-2000-595-TN	B-595	Vinyl	Tan	2.000 (50.8)	50 ft. (15.2 m)	1 Roll (cont.)	M71-R6000

See all BMP®71 Print Ribbon parts on page 337.



# BMP®71 Label Materials

BradyID.com/bmp71

## ToughWash™ Harsh Washdown Labels (B-854, B-855)

- Withstands pressures of high heat, harsh chemicals and numerous washdown cycles
- B-854 offers metal detectable layer to detect foreign debris in food stream
- Legible and long-lasting for even the toughest washdown cycles
- Ideal for use in the Food & Beverage industry

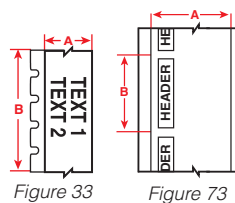

Notice: B-854 and B-855 ToughWash™ materials are not compatible in the TLS®2200 or the HandiMark® Printers.

Diagram	Catalog #	B#	Legend	Label Width A Inch (mm)	Length B Inch (mm)	Labels Per Roll	Rec. Ribbon
<b>B-854 ToughWash™ Metal Detectable Material</b>							
Fig. 33	BM71C-1000-854-WT	B-854		1.000 (25.4)	75ft. (22.8 m)	1 roll (cont.)	M71-R6000
Fig. 33	BM71C-2000-854-WT	B-854		2.000 (50.8)	75ft. (22.8 m)	1 roll (cont.)	M71-R6000
Fig. 33	BM71C-1000-854-YL	B-854		1.000 (25.4)	75ft. (22.8 m)	1 roll (cont.)	M71-R6000
Fig. 33	BM71C-2000-854-YL	B-854		2.000 (50.8)	75ft. (22.8 m)	1 roll (cont.)	M71-R6000
Fig. 73	BM71C-2000-854-CAU	B-854		2.000 (50.8)	4.125 (104.8)	225	M71-R6000
Fig. 73	BM71C-2000-854-DAN	B-854		2.000 (50.8)	4.125 (104.8)	225	M71-R6000
Fig. 73	BM71C-2000-854-WAR	B-854		2.000 (50.8)	4.125 (104.8)	225	M71-R6000
<b>B-855 ToughWash™ Material</b>							
Fig. 33	BM71C-1000-855-WT	B-855		1.000 (25.4)	75ft. (22.8 m)	1 roll (cont.)	M71-R6000
Fig. 33	BM71C-2000-855-WT	B-855		2.000 (50.8)	75ft. (22.8 m)	1 roll (cont.)	M71-R6000
Fig. 33	BM71C-1000-855-YL	B-855		1.000 (25.4)	75ft. (22.8 m)	1 roll (cont.)	M71-R6000
Fig. 33	BM71C-2000-855-YL	B-855		2.000 (50.8)	75ft. (22.8 m)	1 roll (cont.)	M71-R6000
Fig. 73	BM71C-2000-855-CAU	B-855		2.000 (50.8)	4.125 (104.8)	225	M71-R6000
Fig. 73	BM71C-2000-855-DAN	B-855		2.000 (50.8)	4.125 (104.8)	225	M71-R6000
Fig. 73	BM71C-2000-855-WAR	B-855		2.000 (50.8)	4.125 (104.8)	225	M71-R6000

## ToughStripe® Floor Marking Material (B-483)

- Create floor labels using with the same durability and performance as ToughStripe® Floor Marking Tape
- Easy 3-step process: print label, position on floor, apply included overlaminates
- B-483 Polyester Material** - high adhesion to flat, non-coated concrete



Diagram	Catalog #	B#	Material	Color	Label Width A Inch (mm)	Roll Length B Inch (mm)	Labels Per Roll	Rec. Ribbon
<b>B-483 Polyester</b>								
Fig. 33	M71-1000-483-WT-KT	B-483	Polyester	White	1.0 (25.4)	50 ft. (15.2 m)	1 roll (cont.)	M71-R6000
Fig. 33	M71-2000-483-WT-KT	B-483	Polyester	White	2.0 (50.8)	50 ft. (15.2 m)	1 roll (cont.)	M71-R6000
Fig. 33	M71-1000-483-YL-KT	B-483	Polyester	Yellow	1.0 (25.4)	50 ft. (15.2 m)	1 roll (cont.)	M71-R6000
Fig. 33	M71-2000-483-YL-KT	B-483	Polyester	Yellow	2.0 (50.8)	50 ft. (15.2 m)	1 roll (cont.)	M71-R6000
Fig. 33	M71-1000-483-BK-KT	B-483	Polyester	Black	1.0 (25.4)	50 ft. (15.2 m)	1 roll (cont.)	M71-R4400-WT
Fig. 33	M71-2000-483-BK-KT	B-483	Polyester	Black	2.0 (50.8)	50 ft. (15.2 m)	1 roll (cont.)	M71-R4400-WT
Fig. 33	M71-1000-483-BL-KT	B-483	Polyester	Blue	1.0 (25.4)	50 ft. (15.2 m)	1 roll (cont.)	M71-R6000
Fig. 33	M71-2000-483-BL-KT	B-483	Polyester	Blue	2.0 (50.8)	50 ft. (15.2 m)	1 roll (cont.)	M71-R6000
Fig. 33	M71-1000-483-GN-KT	B-483	Polyester	Green	1.0 (25.4)	50 ft. (15.2 m)	1 roll (cont.)	M71-R6000
Fig. 33	M71-2000-483-GN-KT	B-483	Polyester	Green	2.0 (50.8)	50 ft. (15.2 m)	1 roll (cont.)	M71-R6000
Fig. 33	M71-1000-483-OR-KT	B-483	Polyester	Orange	1.0 (25.4)	50 ft. (15.2 m)	1 roll (cont.)	M71-R6000
Fig. 33	M71-2000-483-OR-KT	B-483	Polyester	Orange	2.0 (50.8)	50 ft. (15.2 m)	1 roll (cont.)	M71-R6000
Fig. 33	M71-1000-483-RD-KT	B-483	Polyester	Red	1.0 (25.4)	50 ft. (15.2 m)	1 roll (cont.)	M71-R6000
Fig. 33	M71-2000-483-RD-KT	B-483	Polyester	Red	2.0 (50.8)	50 ft. (15.2 m)	1 roll (cont.)	M71-R6000

See all BMP®71 Print Ribbon parts on page 337.

## Temporary/Removable Labels (B-581)

Designed with special adhesive to easily remove and re-apply.

- **B-581 Repositionable Vinyl Material** - Indoor/outdoor marking film is a high gloss, durable, flexible, pressure sensitive adhesive product

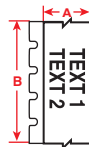

Figure 33



Diagram	Catalog #	B#	Material	Color	Label Width A Inch (mm)	Roll Length B Inch (mm)	Labels Per Roll	Rec. Ribbon
Fig. 33	M71C-500-581-WT	B-581	Vinyl	White	0.500 (12.7)	50 ft. (15.2 m)	1 Roll (cont.)	M71-R6000
Fig. 33	M71C-1000-581-WT	B-581	Vinyl	White	1.000 (25.4)	50 ft. (15.2 m)	1 Roll (cont.)	M71-R6000
Fig. 33	M71C-2000-581-WT	B-581	Vinyl	White	2.000 (50.8)	50 ft. (15.2 m)	1 Roll (cont.)	M71-R6000
Fig. 33	M71C-500-581-YL	B-581	Vinyl	Yellow	0.500 (12.7)	50 ft. (15.2 m)	1 Roll (cont.)	M71-R6000
Fig. 33	M71C-1000-581-YL	B-581	Vinyl	Yellow	1.000 (25.4)	50 ft. (15.2 m)	1 Roll (cont.)	M71-R6000
Fig. 33	M71C-2000-581-YL	B-581	Vinyl	Yellow	2.000 (50.8)	50 ft. (15.2 m)	1 Roll (cont.)	M71-R6000

## Glow-In-The-Dark Labels (B-582)

**B-582 BradyGlo™ Phosphorescent polyester Material**

- absorbs light and will glow in the dark.



Figure 33



Diagram	Catalog #	B#	Material	Color	Label Width A Inch (mm)	Roll Length B Inch (mm)	Labels Per Roll	Rec. Ribbon
Fig. 33	BM71C-1000-582	B-582	Phosphorescent	Phosphorescent	1.000 (25.4)	75 ft. (22.8 m)	1 Roll (cont.)	M71-R6000
Fig. 33	BM71C-2000-582	B-582	Phosphorescent	Phosphorescent	2.000 (50.8)	75 ft. (22.8 m)	1 Roll (cont.)	M71-R6000

## Reflective Labels (B-584)

- **B-584 Reflective Material** - illuminates when light is shined on the surface of the label.



Figure 33



Diagram	Catalog #	B#	Material	Color	Label Width A Inch (mm)	Roll Length B Inch (mm)	Labels Per Roll	Rec. Ribbon
Fig. 33	BM71C-1000-584-YL	B-584	Reflective Tape	Yellow	1.000 (25.4)	75 ft. (22.8 m)	1 Roll (cont.)	M71-R6000
Fig. 33	BM71C-2000-584-YL	B-584	Reflective Tape	Yellow	2.000 (50.8)	75 ft. (22.8 m)	1 Roll (cont.)	M71-R6000
Fig. 33	BM71C-1000-584-OR	B-584	Reflective Tape	Orange	1.000 (25.4)	75 ft. (22.8 m)	1 Roll (cont.)	M71-R6000
Fig. 33	BM71C-2000-584-OR	B-584	Reflective Tape	Orange	2.000 (50.8)	75 ft. (22.8 m)	1 Roll (cont.)	M71-R6000
Fig. 33	BM71C-1000-584-WT	B-584	Reflective Tape	Silver	1.000 (25.4)	75 ft. (22.8 m)	1 Roll (cont.)	M71-R6000
Fig. 33	BM71C-2000-584-WT	B-584	Reflective Tape	Silver	2.000 (50.8)	75 ft. (22.8 m)	1 Roll (cont.)	M71-R6000

## Pre-Printed Calibration & Testing Labels (B-423, B-428, B-483)

- **B-423 Polyester Material** - UL Recognized for outdoor use on glass, thermoset polyester plastic and polyvinyl fluoride plastic.
- **B-428 Polyester Material** - For barcodes, alphanumerics and graphics that require nameplate-like quality.
- **B-483 Polyester Material** - Permanent adhesive for powder-coated/textured surfaces. Best on flat surfaces.

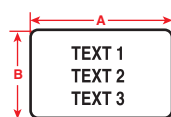
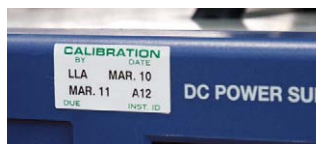

Figure 29

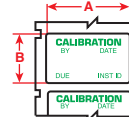

Figure 51

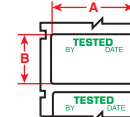

Figure 52

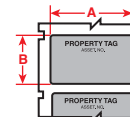

Figure 54

Diagram	Catalog #	B#	Material	Color	Label Width A Inch (mm)	Label Height B Inch (mm)	Labels Per Roll	Rec. Ribbon
<b>B-423 Permanent Polyester</b>								
Fig. 52	M71-30-423-TEST	B-423	Polyester	White	1.500 (38.1)	0.750 (19.1)	250	M71-R6000
<b>B-428 Metallized Polyester</b>								
Fig. 51	M71-30-428-CALI	B-428	Polyester	White	1.500 (38.1)	0.750 (19.1)	250	M71-R4300
Fig. 54	M71-35-428-PROP	B-428	Polyester	White	1.630 (41.4)	0.750 (19.1)	250	M71-R4300
<b>B-483 Polyester Labels</b>								
Fig. 29	M71-38-483-CAUT	B-483	Polyester	White	4.000 (101.6)	1.900 (48.7)	100	M71-R6000
Fig. 29	M71-38-483-DANG	B-483	Polyester	White	4.000 (101.6)	1.900 (48.7)	100	M71-R6000
Fig. 29	M71-38-483-NOTI	B-483	Polyester	White	4.000 (101.6)	1.900 (48.7)	100	M71-R6000
Fig. 29	M71-38-483-WARN	B-483	Polyester	White	4.000 (101.6)	1.900 (48.7)	100	M71-R6000

See all BMP®71 Print Ribbon parts on page 337.



# BMP®71 Label Materials

BradyID.com/bmp71

## General Identification and Rating Plates (B-424, B-430, B-459, B-483, B-486, B-488, B-489)

Choose from several materials with aggressive adhesives for use in commercial/industrial applications.

- **B-424 Paper Material** - White matte paper material
- **B-430 Polyester Material** - Clear glossy polyester
- **B-459 Polyester Material** - White matte polyester
- **B-483 Polyester Material** - White glossy polyester with an aggressive adhesive
- **B-486 Polyester Material** - Metallized matte polyester
- **B-488 Polyester Material** - White matte polyester with an aggressive adhesive
- **B-489 Polyester Material** - White matte polyester with an aggressive adhesive

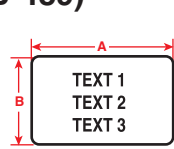

Figure 29

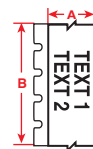

Figure 33



Diagram	Catalog #	B#	Material	Color	Label Width A Inch (mm)	Label Height B Inch (mm)	Labels Per Roll	Rec. Ribbon
<b>B-424 Paper Labels</b>								
Fig. 29	BM71-20-424	B-424	Paper	White	2.000 (50.8)	1.000 (25.4)	1000	M71-R4300
Fig. 29	M71-20-424	B-424	Paper	White	2.000 (50.8)	1.000 (25.4)	100	M71-R4300
<b>B-430 Clear Glossy Polyester Labels</b>								
Fig. 29	M71-68-430	B-430	Polyester	Clear	0.240 (6.0)	0.150 (3.8)	750	M71-R6000
Fig. 29	M71-71-430	B-430	Polyester	Clear	0.350 (8.9)	0.200 (5.1)	750	M71-R6000
Fig. 33	M71C-375-430	B-430	Polyester	Clear	0.375 (9.5)	50 ft. (15.2 m)	1 Roll (cont.)	M71-R6000
Fig. 33	M71C-500-430	B-430	Polyester	Clear	0.500 (12.7)	50 ft. (15.2 m)	1 Roll (cont.)	M71-R6000
Fig. 29	M71-16-430	B-430	Polyester	Clear	1.000 (25.4)	0.375 (9.5)	500	M71-R6000
Fig. 29	M71-17-430	B-430	Polyester	Clear	1.000 (25.4)	0.500 (12.7)	500	M71-R6000
Fig. 33	M71C-1000-430	B-430	Polyester	Clear	1.000 (25.4)	50 ft. (15.2 m)	1 Roll (cont.)	M71-R6000
Fig. 29	M71-45-430	B-430	Polyester	Clear	1.050 (38.1)	0.375 (9.5)	500	M71-R6000
Fig. 33	M71C-1900-430	B-430	Polyester	Clear	1.900 (48.3)	50 ft. (15.2 m)	1 Roll (cont.)	M71-R6000
<b>B-459 Matte Polyester Labels</b>								
Fig. 29	M71-29-459	B-459	Polyester	White	1.500 (38.1)	0.500 (12.7)	500	M71-R6000
Fig. 29	M71-30-459	B-459	Polyester	White	1.500 (38.1)	0.750 (19.1)	250	M71-R6000
Fig. 29	M71-20-459	B-459	Polyester	White	2.000 (50.8)	1.000 (25.4)	100	M71-R6000
<b>B-483 Gloss Polyester Labels with an Aggressive Adhesive</b>								
Fig. 33	M71C-500-483	B-483	Polyester	White	0.500 (12.7)	50 ft. (15.2 m)	1 Roll (cont.)	M71-R6000
Fig. 29	M71-16-483	B-483	Polyester	White	1.000 (25.4)	0.375 (9.5)	500	M71-R6000
Fig. 29	M71-17-483	B-483	Polyester	White	1.000 (25.4)	0.500 (12.7)	500	M71-R6000
Fig. 29	M71-19-483	B-483	Polyester	White	1.000 (25.4)	1.000 (25.4)	250	M71-R6000
Fig. 33	M71C-1000-483	B-483	Polyester	White	1.000 (25.4)	50 ft. (15.2 m)	1 Roll (cont.)	M71-R6000
Fig. 29	M71-65-483	B-483	Polyester	White	1.375 (34.9)	1.000 (25.4)	250	M71-R6000
Fig. 29	M71-29-483	B-483	Polyester	White	1.500 (38.1)	0.500 (12.7)	500	M71-R6000
Fig. 29	M71-30-483	B-483	Polyester	White	1.500 (38.1)	0.750 (19.1)	250	M71-R6000
Fig. 29	M71-31-483	B-483	Polyester	White	1.500 (38.1)	1.000 (25.4)	250	M71-R6000
Fig. 33	M71C-1900-483	B-483	Polyester	White	1.900 (48.3)	50 ft. (15.2 m)	1 Roll (cont.)	M71-R6000
Fig. 29	M71-61-483	B-483	Polyester	White	2.000 (50.8)	0.500 (12.7)	100	M71-R6000
Fig. 29	M71-20-483	B-483	Polyester	White	2.000 (50.8)	1.000 (25.4)	100	M71-R6000
Fig. 29	M71-37-483	B-483	Polyester	White	3.000 (76.2)	1.900 (48.3)	100	M71-R6000
Fig. 29	M71-23-483	B-483	Polyester	White	4.000 (101.6)	1.000 (25.4)	100	M71-R6000
Fig. 29	M71-38-483	B-483	Polyester	White	4.000 (101.6)	1.900 (48.3)	100	M71-R6000
<b>B-486 Metallized Polyester Labels with an Aggressive Adhesive</b>								
Fig. 29	M71-17-486	B-486	Polyester	Silver	1.000 (25.4)	0.500 (12.7)	500	M71-R4300
Fig. 29	M71-29-486	B-486	Polyester	Silver	1.500 (38.1)	0.500 (12.7)	500	M71-R4300
Fig. 29	M71-30-486	B-486	Polyester	Silver	1.500 (38.1)	0.750 (19.1)	250	M71-R4300
Fig. 29	M71-20-486	B-486	Polyester	Silver	2.000 (50.8)	1.000 (25.4)	100	M71-R4300
Fig. 29	M71-37-486	B-486	Polyester	Silver	3.000 (76.2)	1.900 (48.3)	100	M71-R4300
<b>B-488 Matte Polyester Labels</b>								
Fig. 29	M71-80-488	B-488	Polyester	White	0.750 (19.1)	0.900 (22.9)	250	M71-R4300
Fig. 29	M71-97-488	B-488	Polyester	White	0.900 (22.9)	0.900 (22.9)	250	M71-R4300
Fig. 29	M71-81-488	B-488	Polyester	White	1.900 (48.3)	0.250 (6.4)	750	M71-R4300
<b>B-489 Matte Polyester Labels with an Aggressive Adhesive</b>								
Fig. 29	M71-29-489	B-489	Polyester	White	1.500 (38.1)	0.500 (12.7)	500	M71-R4300
Fig. 29	M71-32-489	B-489	Polyester	White	1.500 (38.1)	1.500 (38.1)	250	M71-R4300
Fig. 29	M71-38-489	B-489	Polyester	White	4.000 (101.6)	1.900 (48.3)	100	M71-R4300
Fig. 29	M71-17-489	B-489	Polyester	White	1.000 (25.4)	0.500 (12.7)	500	M71-R4300

See all BMP®71 Print Ribbon parts on page 337.



## Raised Profile Engraved Plate Substitute Labels - Rectangular Style (B-593)

- **B-593 Foam Backed Polyester Material** - Customized legend plates with less hassle and wasted time than engraved plates. RoHS compliant and UL approved. Aggressive adhesive and solvent resistance makes them a great replacement for engraved tags.

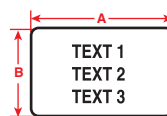

Figure 29



Diagram	Catalog #	B#	Material	Color	Label Width A Inch (mm)	Label Height B Inch (mm)	Labels Per Roll	Rec. Ribbon
<b>B-593 Foam Backed Polyester Label</b>								
Fig. 29	M71EP-171-593	B-593	Polyester	White	1.060 (26.9)	0.490 (12.5)	200	M71-R6000
Fig. 29	M71EP-173-593	B-593	Polyester	White	2.000 (50.8)	1.000 (25.4)	100	M71-R6000
Fig. 29	M71EP-176-593	B-593	Polyester	White	3.000 (76.2)	1.000 (25.4)	50	M71-R6000
Fig. 29	M71EP-174-593	B-593	Polyester	White	4.000 (101.6)	1.000 (25.4)	50	M71-R6000
Fig. 29	M71EP-171-593-YL	B-593	Polyester	Yellow	1.060 (26.9)	0.490 (12.5)	200	M71-R6000
Fig. 29	M71EP-173-593-YL	B-593	Polyester	Yellow	2.000 (50.8)	1.000 (25.4)	100	M71-R6000
Fig. 29	M71EP-176-593-YL	B-593	Polyester	Yellow	3.000 (76.2)	1.000 (25.4)	50	M71-R6000
Fig. 29	M71EP-174-593-YL	B-593	Polyester	Yellow	4.000 (101.6)	1.000 (25.4)	50	M71-R6000
Fig. 29	M71EP-171-593-BK	B-593	Polyester	Black	1.060 (26.9)	0.490 (12.5)	200	M71-R4400-WT
Fig. 29	M71EP-173-593-BK	B-593	Polyester	Black	2.000 (50.8)	1.000 (25.4)	100	M71-R4400-WT
Fig. 29	M71EP-176-593-BK	B-593	Polyester	Black	3.000 (76.2)	1.000 (25.4)	50	M71-R4400-WT
Fig. 29	M71EP-174-593-BK	B-593	Polyester	Black	4.000 (101.6)	1.000 (25.4)	50	M71-R4400-WT
Fig. 29	M71EP-171-593-GN	B-593	Polyester	Green	1.060 (26.9)	0.490 (12.5)	200	M71-R4400-WT
Fig. 29	M71EP-173-593-GN	B-593	Polyester	Green	2.000 (50.8)	1.000 (25.4)	100	M71-R4400-WT
Fig. 29	M71EP-176-593-GN	B-593	Polyester	Green	3.000 (76.2)	1.000 (25.4)	50	M71-R4400-WT
Fig. 29	M71EP-174-593-GN	B-593	Polyester	Green	4.000 (101.6)	1.000 (25.4)	50	M71-R4400-WT
Fig. 29	M71EP-171-593-RD	B-593	Polyester	Red	1.060 (26.9)	0.490 (12.5)	200	M71-R4400-WT
Fig. 29	M71EP-173-593-RD	B-593	Polyester	Red	2.000 (50.8)	1.000 (25.4)	100	M71-R4400-WT
Fig. 29	M71EP-176-593-RD	B-593	Polyester	Red	3.000 (76.2)	1.000 (25.4)	50	M71-R4400-WT
Fig. 29	M71EP-174-593-RD	B-593	Polyester	Red	4.000 (101.6)	1.000 (25.4)	50	M71-R4400-WT
Fig. 29	M71EP-171-593-SL	B-593	Polyester	Silver	1.060 (26.9)	0.490 (12.5)	200	M71-R6000
Fig. 29	M71EP-173-593-SL	B-593	Polyester	Silver	2.000 (50.8)	1.000 (25.4)	100	M71-R6000
Fig. 29	M71EP-174-593-SL	B-593	Polyester	Silver	4.000 (101.6)	1.000 (25.4)	50	M71-R6000

## Raised Profile Engraved Plate Substitute Labels - Push Button Style (B-593)

- **B-593 Foam Backed Polyester Material** - Customized legend plates with less hassle and wasted time than engraved plates. RoHS compliant and UL approved. Aggressive adhesive and solvent resistance makes them a great replacement for engraved tags.

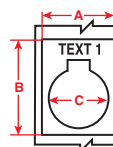

Figure 49



Diagram	Catalog #	B#	Material	Color	Label Width A Inch (mm)	Label Height B Inch (mm)	Hole Diameter C Inch (mm)	Labels Per Roll	Rec. Ribbon
<b>B-593 Foam Backed Polyester Label</b>									
Fig. 49	M71EP-167-593	B-593	Polyester	White	1.200 (30.480)	1.500 (38.1)	0.890 (22.5)	100	M71-R6000
Fig. 49	M71EP-168-593	B-593	Polyester	White	1.200 (30.480)	1.900 (48.3)	0.890 (22.5)	100	M71-R6000
Fig. 49	M71EP-169-593	B-593	Polyester	White	1.800 (45.720)	1.800 (45.7)	1.200 (30.5)	100	M71-R6000
Fig. 49	M71EP-167-593-YL	B-593	Polyester	Yellow	1.200 (30.480)	1.500 (38.1)	0.890 (22.5)	100	M71-R6000
Fig. 49	M71EP-168-593-YL	B-593	Polyester	Yellow	1.200 (30.480)	1.900 (48.3)	0.890 (22.5)	100	M71-R6000
Fig. 49	M71EP-169-593-YL	B-593	Polyester	Yellow	1.800 (45.720)	1.800 (45.7)	1.200 (30.5)	100	M71-R6000
Fig. 49	M71EP-167-593-BK	B-593	Polyester	Black	1.200 (30.480)	1.500 (38.1)	0.890 (22.5)	100	M71-R4400-WT
Fig. 49	M71EP-168-593-BK	B-593	Polyester	Black	1.200 (30.480)	1.900 (48.3)	0.890 (22.5)	100	M71-R4400-WT
Fig. 49	M71EP-169-593-BK	B-593	Polyester	Black	1.800 (45.720)	1.800 (45.7)	1.200 (30.5)	100	M71-R4400-WT
Fig. 49	M71EP-167-593-GN	B-593	Polyester	Green	1.200 (30.480)	1.500 (38.1)	0.890 (22.5)	100	M71-R4400-WT
Fig. 49	M71EP-168-593-GN	B-593	Polyester	Green	1.200 (30.480)	1.900 (48.3)	0.890 (22.5)	100	M71-R4400-WT
Fig. 49	M71EP-169-593-GN	B-593	Polyester	Green	1.800 (45.720)	1.800 (45.7)	1.200 (30.5)	100	M71-R4400-WT
Fig. 49	M71EP-167-593-RD	B-593	Polyester	Red	1.200 (30.480)	1.500 (38.1)	0.890 (22.5)	100	M71-R4400-WT
Fig. 49	M71EP-168-593-RD	B-593	Polyester	Red	1.200 (30.480)	1.900 (48.3)	0.890 (22.5)	100	M71-R4400-WT
Fig. 49	M71EP-169-593-RD	B-593	Polyester	Red	1.800 (45.720)	1.800 (45.7)	1.200 (30.5)	100	M71-R4400-WT



# BMP®71 Label Materials

BradyID.com/bmp71

## Patch Panel Strips (B-412, B-422)

- **B-412 Polypropylene Non-Adhesive Tag Stock Strips** - Designed for high legibility and tensile strength.
- **B-422 Polyester Material** - Permanent adhesive, good for powder-coated/textured surfaces. Best on flat surfaces. Temp. Range: -40°F to 212°F (-40°C to 100°C). UL recognized.



Figure 28

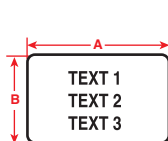

Figure 29

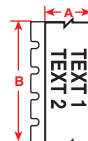

Figure 33

Diagram	Catalog #	B#	Material	Color	Label Width A Inch (mm)	Label Height B Inch (mm)	Labels Per Roll	Rec. Ribbon
<b>B-412 Non-Adhesive Polypropylene Material</b>								
Fig. 28	M71C-230-412	B-412	Polyethylene Non-Adhesive Strip	White	0.230 (5.8)	50 ft. (15.2 m)	1 Roll (cont.)	M71-R6200
Fig. 28	M71C-375-412	B-412	Polyethylene Non-Adhesive Strip	White	0.375 (9.5)	50 ft. (15.2 m)	1 Roll (cont.)	M71-R6200
Fig. 33	M71C-475-412	B-412	Polyethylene Non-Adhesive Strip	White	0.475 (12.1)	50 ft. (15.2 m)	1 Roll (cont.)	M71-R6200
Fig. 28	M71C-500-412	B-412	Polyethylene Non-Adhesive Strip	White	0.500 (12.7)	50 ft. (15.2 m)	1 Roll (cont.)	M71-R6200
Fig. 33	M71C-625-412	B-412	Polyethylene Non-Adhesive Strip	White	0.625 (15.9)	50 ft. (15.2 m)	1 Roll (cont.)	M71-R6200
Fig. 28	M71C-785-412	B-412	Polyethylene Non-Adhesive Strip	White	0.785 (19.9)	50 ft. (15.2 m)	1 Roll (cont.)	M71-R6200
<b>B-422 Permanent Adhesive Polyester Material</b>								
Fig. 33	M71C-375-422	B-422	Polyester Adhesive Strip	White	0.375 (9.5)	50 ft. (15.2 m)	1 Roll (cont.)	M71-R6000
Fig. 33	M71C-475-422	B-422	Polyester Adhesive Strip	White	0.475 (12.1)	50 ft. (15.2 m)	1 Roll (cont.)	M71-R6000
Fig. 33	M71C-500-422	B-422	Polyester Adhesive Strip	White	0.500 (12.7)	50 ft. (15.2 m)	1 Roll (cont.)	M71-R6000
Fig. 33	M71C-625-422	B-422	Polyester Adhesive Strip	White	0.625 (15.9)	50 ft. (15.2 m)	1 Roll (cont.)	M71-R6000
Fig. 33	M71C-1000-422	B-422	Polyester Adhesive Strip	White	1.000 (25.4)	50 ft. (15.2 m)	1 Roll (cont.)	M71-R6000
Fig. 29	M71-45-422	B-422	Polyester Individual Labels	White	1.500 (38.1)	0.375 (9.5)	500	M71-R6000
Fig. 29	M71-30-422	B-422	Polyester Individual Labels	White	1.500 (38.1)	0.750 (19.1)	250	M71-R6000
Fig. 33	M71C-1900-422	B-422	Polyester Adhesive Strip	White	1.900 (48.3)	50 ft. (15.2 m)	1 Roll (cont.)	M71-R6000
Fig. 29	BM71-20-422	B-422	Polyester Individual Labels	White	2.000 (50.8)	1.000 (25.4)	1000	M71-R6000
Fig. 29	M71-37-422	B-422	Polyester Individual Labels	White	3.000 (76.2)	1.900 (48.3)	100	M71-R6000

## Faceplate, Outlet & Port Labels (B-412, B-423, B-595)

- **B-412 Polypropylene Tag Material** - Designed for high legibility and tensile strength.
- **B-423 Polyester Material** - White glossy polyester
- **B-595 Indoor/Outdoor Vinyl Material** Aggressive permanent adhesive, very pliable, conforms to rough surfaces, excellent resistance to oils, detergents, dirt, and many solvents. 8-10 year average outdoor durability.

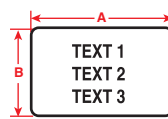

Figure 29

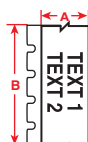

Figure 33

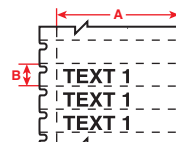

Figure 55



Diagram	Catalog #	B#	Material	Color	Label Width A Inch (mm)	Label Height B Inch (mm)	Labels Per Roll	Rec. Ribbon
<b>B-412 Non-Adhesive Polypropylene Tag Material</b>								
Fig. 55	BM71-40-412	B-412	Non-adhesive Strip	White	1.938 (49.2)	0.375 (9.5)	5000	M71-R6200
Fig. 55	M71-40-412	B-412	Non-adhesive Strip	White	1.938 (49.2)	0.375 (9.5)	750	M71-R6200
<b>B-423 Permanent Polyester Material</b>								
Fig. 29	M71-7-423	B-423	Polyester	White	0.500 (12.700)	0.500 (12.700)	500	M71-R6000
Fig. 33	M71C-500-423	B-423	Polyester Strip	White	0.500 (12.700)	50 ft. (15.24 m)	1 Roll (cont.)	M71-R6000
Fig. 29	M71-16-423	B-423	Polyester Individual Labels	White	1.000 (25.400)	0.375 (9.530)	500	M71-R6000
Fig. 29	M71-17-423	B-423	Polyester Individual Labels	White	1.000 (25.400)	0.500 (12.700)	500	M71-R6000
Fig. 29	M71-29-423	B-423	Polyester Individual Labels	White	1.500 (38.100)	0.500 (12.700)	500	M71-R6000
<b>B-595 Indoor/Outdoor Vinyl Film</b>								
Fig. 33	M71C-500-595-WT	B-595	Vinyl Strip	White	0.500 (12.7)	50 ft. (15.2 m)	1 Roll (cont.)	M71-R6000

See all BMP®71 Print Ribbon parts on page 337.

## Non-Adhesive Tags (B-145, B-109)

- **B-145 Polyethylene Tags and B-145FR Fire Retardant Polyethylene Tag Material** - non-adhesive hang tags are made of 9.5 mil cross laminated polyethylene film with a thermal transfer printable topcoat. Used for a variety of tag applications including ID of multiconductor cables and equipment.
- **B-109 Polyethylene Tag Material** - Multipurpose tag that can be used for a variety of applications including identification of multiconductor cables, inventory, equipment, lockout and work-in-progress. Extremely tear resistant and superior cold-weather tag.

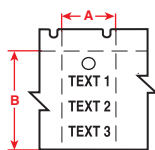

Figure 45

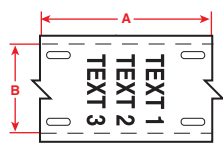

Figure 56

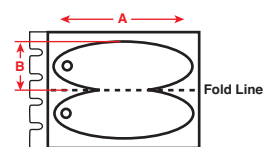

Figure 50



Diagram	Catalog #	B#	Material	Color	Label Width A Inch (mm)	Label Height B Inch (mm)	Labels Per Roll	Rec. Ribbon
<b>B-109 Polyethylene Tags</b>								
Fig. 45	M71-36-109	B-109	Polyethylene	White	1.125 (28.6)	1.750 (44.5)	250	M71-R4300
Fig. 56	M71-12-109	B-109	Polyethylene	White	3.000 (76.2)	0.750 (19.1)	100	M71-R4300
Fig. 56	BM71-12-109	B-109	Polyethylene	White	3.000 (76.2)	0.750 (19.1)	1000	M71-R4300
<b>B-145 Polyethylene Tags</b>								
Fig. 50	BM71-111-145-GY	B-145	Polyethylene	Gray	1.206 (30.6)	0.758 (19.3)	1000	M71-R6000
Fig. 50	M71-111-145-GY	B-145	Polyethylene	Gray	1.206 (30.6)	0.758 (19.3)	100	M71-R6000
Fig. 50	BM71-110-145-GY	B-145	Polyethylene	Gray	1.750 (44.5)	1.000 (25.4)	1000	M71-R6000
Fig. 50	M71-110-145-GY	B-145	Polyethylene	Gray	1.750 (44.5)	1.000 (25.4)	100	M71-R6000
Fig. 50	M71-111-145FR-GY	B-145FR	Polyethylene	Gray	1.206 (30.6)	0.758 (19.3)	100	M71-R6000
Fig. 50	M71-110-145FR-GY	B-145FR	Polyethylene	Gray	1.750 (44.5)	1.000 (25.4)	100	M71-R6000

## Fiber Optic Cable Flags (B-425)

Allows more legible information on smaller diameter wires and permits you to handle and view labels without touching the wires.

- **B-425 Polypropylene Material** - Excellent solvent resistance and print performance.

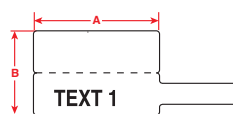

Figure 47

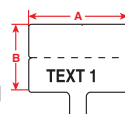

Figure 48



Diagram	Catalog #	B#	Material	Color	Label Width A Inch (mm)	Label Height B Inch (mm)	Labels Per Roll	Rec. Ribbon
<b>B-425 Polypropylene Labels</b>								
Fig. 47	M71FP-1-425	B-425	Polypropylene	White	1.180 (30.0)	0.788 (20.0)	250	M71-R4300
Fig. 48	M71FT-1-425	B-425	Polypropylene	White	1.180 (30.0)	0.788 (20.0)	250	M71-R4300
Fig. 47	M71FP-2-425	B-425	Polypropylene	White	1.750 (44.5)	1.000 (25.4)	100	M71-R4300

## Terminal Block Adhesive Strips (B-498)

- **B-498 Repositionable vinyl cloth material** - industrial strength and ideal for curved surfaces. Firm adhesive can be removed cleanly and reapplied.

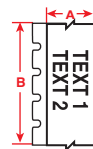

Figure 33



Diagram	Catalog #	B#	Material	Color	Label Width A Inch (mm)	Label Height B Inch (mm)	Labels Per Roll	Rec. Ribbon
Fig. 33	M71C-240-498	B-498	Vinyl Cloth	White	0.240 (6.1)	30 ft. (9.1 m)	1 Roll (cont.)	M71-R6200
Fig. 33	M71C-318-498	B-498	Vinyl Cloth	White	0.318 (8.1)	30 ft. (9.1 m)	1 Roll (cont.)	M71-R6200
Fig. 33	M71C-375-498	B-498	Vinyl Cloth	White	0.375 (9.5)	30 ft. (9.1 m)	1 Roll (cont.)	M71-R6200
Fig. 33	BM71C-240-498	B-498	Vinyl Cloth	White	0.240 (6.1)	275 ft. (83.8 m)	1 Roll (cont.)	M71-R6200
Fig. 33	BM71C-318-498	B-498	Vinyl Cloth	White	0.318 (8.1)	275 ft. (83.8 m)	1 Roll (cont.)	M71-R6200
Fig. 33	BM71C-375-498	B-498	Vinyl Cloth	White	0.375 (9.5)	275 ft. (83.8 m)	1 Roll (cont.)	M71-R6200

# BMP®71 Label Materials

BradyID.com/bmp71

## Adhesive Cloth Wire and Cable Wraps (B-498, B-499)

- **B-498 Repositionable Vinyl Cloth Material** - Industrial strength and ideal for curved surfaces. Firm adhesive can be removed cleanly and reapplied.
- **B-499 Permanent Nylon Cloth Material** - Durable industrial strength and designed to conform to curved surfaces.

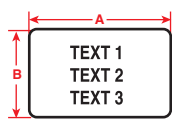

Figure 29

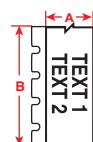

Figure 33



Portable Printers

Diagram	Catalog #	Material	Color	Approx. Wire Gauge	Label Width A Inch (mm)	Label Height B Inch (mm)	Labels Per Roll	Rec. Ribbon
<b>B-498 Repositionable Vinyl Cloth Labels</b>								
Fig. 29	M71-7-498	B-498	White	16-10	0.500 (12.7)	0.500 (12.7)	500	M71-R6200
Fig. 29	M71-17-498	B-498	White	12-10	1.000 (25.4)	0.500 (12.7)	500	M71-R6200
Fig. 29	M71-10-498	B-498	White	16-10	0.250 (6.4)	0.750 (19.1)	750	M71-R6200
Fig. 29	BM71-11-498	B-498	White	16-10	0.500 (12.7)	0.750 (19.1)	5000	M71-R6200
Fig. 29	M71-11-498	B-498	White	16-10	0.500 (12.7)	0.750 (19.1)	500	M71-R6200
Fig. 29	M71-16-498	B-498	White	12-10	0.375 (9.5)	1.000 (25.4)	500	M71-R6200
Fig. 29	BM71-18-498	B-498	White	12-10	0.750 (19.1)	1.000 (25.4)	2500	M71-R6200
Fig. 29	M71-18-498	B-498	White	12-10	0.750 (19.1)	1.000 (25.4)	250	M71-R6200
Fig. 29	BM71-19-498	B-498	White	12-10	1.000 (25.4)	1.000 (25.4)	2500	M71-R6200
Fig. 29	M71-19-498	B-498	White	12-10	1.000 (25.4)	1.000 (25.4)	250	M71-R6200
Fig. 29	BM71-29-498	B-498	White	10-4	0.500 (12.7)	1.500 (38.1)	5000	M71-R6200
Fig. 29	M71-29-498	B-498	White	10-4	0.500 (12.7)	1.500 (38.1)	500	M71-R6200
Fig. 29	M71-30-498	B-498	White	10-4	0.750 (19.1)	1.500 (38.1)	250	M71-R6200
Fig. 29	M71-31-498	B-498	White	10-4	1.000 (25.4)	1.500 (38.1)	250	M71-R6200
Fig. 29	M71-32-498	B-498	White	10-4	1.500 (38.1)	1.500 (38.1)	250	M71-R6200
Fig. 29	M71-21-498	B-498	White	Cables	1.000 (25.4)	2.500 (63.5)	100	M71-R6200
Fig. 29	M71-33-498	B-498	White	Cables	1.500 (38.1)	4.000 (101.6)	100	M71-R6200
Fig. 33	M71C-500-498	B-498	White	-	0.500 (12.7)	30 ft. (9.1 m)	1 Roll (cont.)	M71-R6200
Fig. 33	M71C-1000-498	B-498	White	-	1.000 (25.4)	30 ft. (9.1 m)	1 Roll (cont.)	M71-R6200
Fig. 33	M71C-1900-498	B-498	White	-	1.900 (48.3)	30 ft. (9.1 m)	1 Roll (cont.)	M71-R6200
<b>B-499 Nylon Cloth Labels</b>								
Fig. 29	M71-7-499	B-499	White	16-10	0.500 (12.7)	0.500 (12.7)	500	M71-R4300
Fig. 29	BM71-11-499	B-499	White	16-10	0.500 (12.7)	0.750 (19.1)	5000	M71-R4300
Fig. 29	M71-11-499	B-499	White	16-10	0.500 (12.7)	0.750 (19.1)	500	M71-R4300
Fig. 29	M71-16-499	B-499	White	12-10	0.375 (9.5)	1.000 (25.4)	500	M71-R4300
Fig. 29	M71-18-499	B-499	White	12-10	0.750 (19.1)	1.000 (25.4)	250	M71-R4300
Fig. 29	M71-19-499	B-499	White	12-10	1.000 (25.4)	1.000 (25.4)	250	M71-R4300
Fig. 29	M71-78-499	B-499	White	12-10	1.900 (48.3)	1.000 (25.4)	250	M71-R4300
Fig. 29	M71-28-499	B-499	White	10-4	0.250 (6.4)	1.500 (38.1)	750	M71-R4300
Fig. 29	M71-29-499	B-499	White	10-4	0.500 (12.7)	1.500 (38.1)	500	M71-R4300
Fig. 29	M71-30-499	B-499	White	10-4	0.750 (19.1)	1.500 (38.1)	250	M71-R4300
Fig. 29	M71-31-499	B-499	White	10-4	1.000 (25.4)	1.500 (38.1)	250	M71-R4300
Fig. 29	M71-21-499	B-499	White	Cables	1.000 (25.4)	2.500 (63.5)	100	M71-R4300
Fig. 33	M71C-500-499	B-499	White	-	0.500 (12.7)	30 ft. (9.1 m)	1 Roll (cont.)	M71-R4300
Fig. 33	M71C-1000-499	B-499	White	-	1.000 (25.4)	30 ft. (9.1 m)	1 Roll (cont.)	M71-R4300
Fig. 33	M71C-1900-499	B-499	White	-	1.900 (48.3)	30 ft. (9.1 m)	1 Roll (cont.)	M71-R4300

\* Approx. wire gauge based on AWG for THHN wire.

## Polyimide High Temp Adhesive Wire & Cable Labels (B-472)

- **B-472 Polyimide Material** - Polyimide material specifically designed to self-extinguish and prevent flames from propagating.

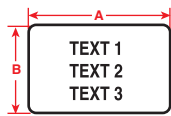

Figure 29

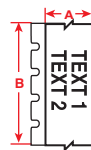

Figure 33



Diagram	Catalog #	B#	Material	Color	Approx. Wire Gauge	Label Width A Inch (mm)	Label Height B Inch (mm)	Print-On Height C Inch (mm)	Labels Per Roll	Rec. Ribbon
Fig 29	M71-9-472	B-472	Polyimide	White	16-10	0.200 (5.1)	0.650 (25.4)	-	750	M71-R4300
Fig 29	M71-10-472	B-472	Polyimide	White	16-10	0.250 (6.4)	0.750 (25.4)	-	750	M71-R4300
Fig 29	M71-30-472	B-472	Polyimide	White	16-10	1.500 (38.1)	0.750 (38.1)	-	250	M71-R4300
Fig 29	M71-15-472	B-472	Polyimide	White	12-10	0.275 (7.0)	1.000 (25.4)	-	750	M71-R4300
Fig 29	M71-17-472	B-472	Polyimide	White	12-10	0.500 (12.7)	1.000 (25.4)	-	500	M71-R4300
Fig 29	M71-19-472	B-472	Polyimide	White	12-10	1.000 (25.4)	1.000 (25.4)	-	250	M71-R4300
Fig 29	M71-21-472	B-472	Polyimide	White	12-10	2.500 (63.5)	1.000 (38.1)	-	100	M71-R4300
Fig 29	M71-29-472	B-472	Polyimide	White	10-4	0.500 (12.7)	1.500 (19.1)	-	500	M71-R4300
Fig 29	M71-31-472	B-472	Polyimide	White	10-4	1.000 (25.4)	1.500 (16.5)	-	250	M71-R4300
Fig 33	M71C-1000-472	B-472	Polyimide	White	-	1.000 (25.4)	50 ft. (15.2 m)	-	1 Roll (cont.)	M71-R4300
Fig 33	M71C-1500-472	B-472	Polyimide	White	-	1.500 (38.1)	50 ft. (15.2 m)	-	1 Roll (cont.)	M71-R4300
Fig 33	M71C-2000-472	B-472	Polyimide	White	-	2.000 (50.8)	50 ft. (15.2 m)	-	1 Roll (cont.)	M71-R4300
Fig 33	M71C-1000-472-YL	B-472	Polyimide	Yellow	-	1.000 (38.1)	50 ft. (15.2 m)	-	1 Roll (cont.)	M71-R4300
Fig 33	M71C-1500-472-YL	B-472	Polyimide	Yellow	-	1.500 (50.8)	50 ft. (15.2 m)	-	1 Roll (cont.)	M71-R4300
Fig 33	M71C-2000-472-YL	B-472	Polyimide	Yellow	-	2.000 (38.1)	50 ft. (15.2 m)	-	1 Roll (cont.)	M71-R4300

Approx. wire gauge based on AWG for THHN wire. TEDLAR® is a registered trademark of DuPont.

See all BMP®71 Print Ribbon parts on page 337.

## Tedlar® Adhesive Wire & Cable Labels (B-642)

- **B-642 Material** - Self-extinguishing material used for wire & cable marking applications, particularly in aerospace, defense and mass transit industries.

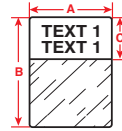

Figure 32



Diagram	Catalog #	B#	Material	Color	Approx. Wire Gauge	Label Width A Inch (mm)	Label Height B Inch (mm)	Print-On Height C Inch (mm)	Labels Per Roll	Rec. Ribbon
Fig 32	M71-19-642	B-642	Tedlar	White	12 to 10	1.000 (25.400)	1.000 (25.400)	0.375 (9.530)	250	M71-R4300
Fig 32	M71-31-642	B-642	Tedlar	White	10 to 4	1.000 (25.400)	1.500 (38.100)	0.500 (12.700)	250	M71-R6200
Fig 32	M71-21-642	B-642	Tedlar	White	25 Pair Copper	1.000 (25.400)	2.500 (63.500)	0.750 (38.1)	100	M71-R6200

Approx. wire gauge based on AWG for THHN wire.

TEDLAR® is a registered trademark of DuPont.

## Self Laminating Wire & Cable Labels (B-427)

- **B-427 Self-Laminating Vinyl Material**

Wire markers with superior chemical and abrasion resistance. Non-printed clear area that wraps around to overlaminate the printed text. UL recognized and Rohs compliant.

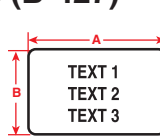

Figure 29

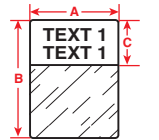

Figure 32

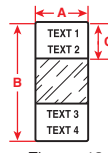

Figure 43



Diagram	Catalog #	B#	Color	Approx. Wire Gauge	Label Width A Inch (mm)	Label Height B Inch (mm)	Print-On Height C Inch (mm)	Labels Per Row	Labels Per Roll	Rec. Ribbon
<b>B-427 Self-Laminating Vinyl Labels</b>										
Fig. 32	M71-10-427	B-427	White	16-10	0.250 (6.350)	0.750 (19.050)	0.375 (9.530)	1	750	M71-R4300
Fig. 32	M71-11-427	B-427	White	16-10	0.500 (12.700)	0.750 (19.050)	0.375 (9.530)	1	500	M71-R4300
Fig. 32	BM71-11-427	B-427	White	16-10	0.500 (12.700)	0.750 (19.050)	0.375 (9.530)	1	5000	M71-R4300
Fig. 32	M71-96-427	B-427	White	16-10	1.000 (25.400)	0.750 (19.050)	0.375 (9.530)	1	250	M71-R4300
Fig. 29	M71-30-427-AW	B-427	White	10-4	1.500 (38.100)	0.750 (19.050)	-	1	250	M71-R4300
Fig. 32	M71-17-427	B-427	White	12-10	0.500 (12.700)	1.000 (25.400)	0.375 (9.530)	1	500	M71-R4300
Fig. 32	BM71-17-427	B-427	White	12-10	0.500 (12.700)	1.000 (25.400)	0.375 (9.530)	1	5000	M71-R4300
Fig. 32	M71-18-427	B-427	White	10-4	0.750 (19.050)	1.000 (25.400)	0.375 (9.530)	1	250	M71-R4300
Fig. 32	BM71-18-427	B-427	White	10-4	0.750 (19.050)	1.000 (25.400)	0.375 (9.530)	1	2500	M71-R4300
Fig. 32	M71-19-427	B-427	White	12-10	1.000 (25.400)	1.000 (25.400)	0.375 (9.530)	1	250	M71-R4300
Fig. 32	BM71-19-427	B-427	White	12-10	1.000 (25.400)	1.000 (25.400)	0.375 (9.530)	1	2500	M71-R4300
Fig. 32	M71-104-427	B-427	White	12-10	1.500 (38.100)	1.000 (25.400)	0.375 (9.530)	1	250	M71-R4300
Fig. 32	M71-103-427	B-427	White	10-4	1.000 (25.400)	1.250 (31.750)	0.500 (12.700)	1	250	M71-R4300
Fig. 32	M71-28-427	B-427	White	10-4	0.250 (6.350)	1.500 (38.100)	0.500 (12.700)	1	750	M71-R4300
Fig. 32	M71-29-427	B-427	White	10-4	0.500 (12.700)	1.500 (38.100)	0.500 (12.700)	1	500	M71-R4300
Fig. 32	BM71-29-427	B-427	White	10-4	0.500 (12.700)	1.500 (38.100)	0.500 (12.700)	1	5000	M71-R4300
Fig. 32	M71-30-427	B-427	White	10-4	0.750 (19.050)	1.500 (38.100)	0.500 (12.700)	1	250	M71-R4300
Fig. 32	BM71-30-427	B-427	White	10-4	0.750 (19.050)	1.500 (38.100)	0.500 (12.700)	1	2500	M71-R4300
Fig. 32	M71-31-427	B-427	White	10-4	1.000 (25.400)	1.500 (38.100)	0.500 (12.700)	1	250	M71-R4300
Fig. 32	BM71-31-427	B-427	White	10-4	1.000 (25.400)	1.500 (38.100)	0.500 (12.700)	1	2500	M71-R4300
Fig. 32	M71-32-427	B-427	White	10-4	1.500 (38.100)	1.500 (38.100)	0.500 (12.700)	1	250	M71-R4300
Fig. 32	BM71-32-427	B-427	White	10-4	1.500 (38.100)	1.500 (38.100)	0.500 (12.700)	1	1000	M71-R4300
Fig. 32	M71-88-427	B-427	White	10-4	1.750 (44.450)	1.500 (38.100)	0.500 (12.700)	1	250	M71-R4300
Fig. 32	M71-107-427	B-427	White	10-4	2.000 (50.800)	1.500 (38.100)	0.500 (12.700)	1	100	M71-R4300
Fig. 32	BM71-107-427	B-427	White	10-4	2.000 (50.800)	1.500 (38.100)	0.500 (12.700)	1	1000	M71-R4300
Fig. 32	M71-21-427	B-427	White	Cables	1.000 (25.400)	2.500 (63.500)	0.750 (19.050)	1	100	M71-R4300
Fig. 32	BM71-21-427	B-427	White	Cables	1.000 (25.400)	2.500 (63.500)	0.750 (19.050)	1	1000	M71-R4300
Fig. 32	M71-66-427	B-427	White	Cables	1.938 (49.230)	3.150 (80.000)	1.000 (25.400)	1	100	M71-R4300
Fig. 43	M71-64-427	B-427	White	Cables	1.000 (25.400)	3.375 (85.730)	1.125 (28.580)	1	100	M71-R4300
Fig. 43	BM71-64-427	B-427	White	Cables	1.000 (25.400)	3.375 (85.730)	1.125 (28.580)	1	1000	M71-R4300
Fig. 32	M71-23-427	B-427	White	Cables	1.000 (25.400)	4.000 (101.600)	1.000 (25.400)	1	100	M71-R4300
Fig. 32	BM71-23-427	B-427	White	Cables	1.000 (25.400)	4.000 (101.600)	1.000 (25.400)	1	1000	M71-R4300
Fig. 32	M71-109-427	B-427	White	Cables	1.500 (38.100)	4.000 (101.600)	1.500 (38.100)	1	100	M71-R4300
Fig. 32	M71-33-427	B-427	White	Cables	1.500 (38.100)	4.000 (101.600)	1.000 (25.400)	1	100	M71-R4300
Fig. 32	BM71-109-427	B-427	White	Cables	1.500 (38.100)	4.000 (101.600)	1.500 (38.100)	1	500	M71-R4300
Fig. 32	BM71-33-427	B-427	White	Cables	1.500 (38.100)	4.000 (101.600)	1.000 (25.400)	1	500	M71-R4300
Fig. 32	M71-34-427	B-427	White	Cables	1.500 (38.100)	6.000 (152.400)	1.500 (38.100)	1	50	M71-R4300
Fig. 32	BM71-34-427	B-427	White	Cables	1.500 (38.100)	6.000 (152.400)	1.500 (38.100)	1	500	M71-R4300
Fig. 32	M71-19-427-YL	B-427	Yellow	12-10	1.000 (25.400)	1.000 (25.400)	0.375 (9.530)	1	250	M71-R4300
Fig. 32	M71-31-427-YL	B-427	Yellow	10-4	1.000 (25.400)	1.500 (38.100)	0.500 (12.700)	1	250	M71-R4300
Fig. 32	M71-32-427-YL	B-427	Yellow	10-4	1.500 (38.100)	1.500 (38.100)	0.500 (12.700)	1	250	M71-R4300
Fig. 32	M71-21-427-YL	B-427	Yellow	Cables	1.000 (25.400)	2.500 (63.500)	0.750 (19.050)	1	100	M71-R4300
Fig. 32	M71-33-427-YL	B-427	Yellow	Cables	1.500 (38.100)	4.000 (101.600)	1.000 (25.400)	1	100	M71-R4300
Fig. 32	M71-30-427-BL	B-427	Blue	10-4	0.750 (19.050)	1.500 (38.100)	0.500 (12.700)	1	250	M71-R4300
Fig. 32	M71-30-427-PL	B-427	Purple	10-4	0.750 (19.050)	1.500 (38.100)	0.500 (12.700)	1	250	M71-R4300
Fig. 32	M71-31-427-GN	B-427	Green	10-4	1.000 (25.400)	1.500 (38.100)	0.500 (12.700)	1	250	M71-R4300
Fig. 32	M71-30-427-RD	B-427	Red	10-4	0.750 (19.050)	1.500 (38.100)	0.500 (12.700)	1	250	M71-R4300
Fig. 32	M71-31-427-RD	B-427	Red	10-4	1.000 (25.400)	1.500 (38.100)	0.500 (12.700)	1	250	M71-R4300

\* Approx. wire gauge based on AWG for THHN wire. See all BMP®71 Print Ribbon parts on page 337.



# BMP®71 Label Materials

BradyID.com/bmp71

## PermaSleeve® PS Wire Marking Sleeves (B-342)

3:1 heat shrinkable single-side printable sleeves  
fit snugly around wire for identification & protection.  
Fade resistant and flame retardant. Meets the following  
material and physical property specifications.

- SAE-AMS-DTL-23053/5C (Class 1)
- SAE-AS-81531
- MIL-STD-202
- RoHS Compliant
- UL Recognized
- Tested per: ASTM E162 and ASTM E662

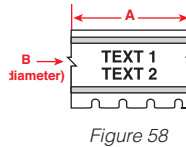
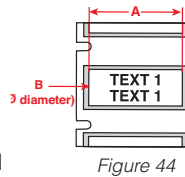

Portable Printers

Diagram	Catalog #	Color	Approx. Wire Gauge	For Wire Diameters Inch (mm) Min. Max.	Supplied Diameter B Inch (mm)	Recovered Diameter Inch (mm)	Recovered Wall Thickness Inch (mm)	Sleeves Per Row	Per Roll	Rec. Ribbon
<b>3:1 Shrink ratio single-side printable, 1" sleeve width (dimension A):</b>										
Fig. 44	M71-94-1-342	White	28 to 20	0.023 (0.6) - 0.080 (2.0)	0.094 (2.4)	0.024 (0.6)	.024 (0.6) ± .003 (0.07)	1	100	M71-R4300
Fig. 44	BM71-125-1-342	White	22 to 16	0.046 (1.2) - 0.110 (2.8)	0.125 (3.2)	0.047 (1.2)	.020 (0.5) ± .003 (0.07)	1	1000	M71-R4300
Fig. 44	M71-125-1-342	White	22 to 16	0.046 (1.2) - 0.110 (2.8)	0.125 (3.2)	0.047 (1.2)	.020 (0.5) ± .003 (0.07)	1	100	M71-R4300
Fig. 44	BM71-187-1-342	White	20 to 10	0.062 (1.6) - 0.150 (3.8)	0.187 (4.7)	0.062 (1.6)	.020 (0.5) ± .003 (0.07)	1	1000	M71-R4300
Fig. 44	M71-187-1-342	White	20 to 10	0.062 (1.6) - 0.150 (3.8)	0.187 (4.7)	0.062 (1.6)	.020 (0.5) ± .003 (0.07)	1	100	M71-R4300
Fig. 44	BM71-250-1-342	White	16 to 8	0.094 (2.4) - 0.215 (5.5)	0.250 (6.4)	0.093 (2.4)	.025 (0.6) ± .003 (0.07)	1	1000	M71-R4300
Fig. 44	M71-250-1-342	White	16 to 8	0.094 (2.4) - 0.215 (5.5)	0.250 (6.4)	0.093 (2.4)	.025 (0.6) ± .003 (0.07)	1	100	M71-R4300
Fig. 44	BM71-375-1-342	White	12 to 4	0.125 (3.2) - 0.320 (8.1)	0.375 (9.5)	0.125 (3.1)	.025 (0.6) ± .003 (0.07)	1	1000	M71-R4300
Fig. 44	M71-375-1-342	White	12 to 4	0.125 (3.2) - 0.320 (8.1)	0.375 (9.5)	0.125 (3.1)	.025 (0.6) ± .003 (0.07)	1	100	M71-R4300
Fig. 44	BM71-500-1-342	White	8 to 1	0.187 (4.8) - 0.450 (11.4)	0.500 (12.7)	0.187 (4.7)	.025 (0.6) ± .003 (0.07)	1	1000	M71-R4300
Fig. 44	M71-500-1-342	White	8 to 1	0.187 (4.8) - 0.450 (11.4)	0.500 (12.7)	0.187 (4.7)	.025 (0.6) ± .003 (0.07)	1	100	M71-R4300
Fig. 44	M71-1000-1-342	White	2 to 0.950 dia.	0.333 (8.5) - 0.950 (24.1)	1.000 (25.4)	0.375 (9.5)	.036 (0.9) ± .003 (0.07)	1	50	M71-R4300
Fig. 44	M71-94-1-342YL	Yellow	28 to 20	0.023 (0.6) - 0.080 (2.0)	0.094 (2.4)	0.024 (0.6)	.024 (0.6) ± .003 (0.07)	1	100	M71-R4300
Fig. 44	M71-125-1-342YL	Yellow	22 to 16	0.046 (1.2) - 0.110 (2.8)	0.125 (3.2)	0.047 (1.2)	.020 (0.5) ± .003 (0.07)	1	100	M71-R4300
Fig. 44	BM71-187-1-342YL	Yellow	20 to 10	0.062 (1.6) - 0.150 (3.8)	0.187 (4.7)	0.062 (1.6)	.020 (0.5) ± .003 (0.07)	1	1000	M71-R4300
Fig. 44	M71-187-1-342YL	Yellow	20 to 10	0.062 (1.6) - 0.150 (3.8)	0.187 (4.7)	0.062 (1.6)	.020 (0.5) ± .003 (0.07)	1	100	M71-R4300
Fig. 44	M71-250-1-342YL	Yellow	16 to 8	0.094 (2.4) - 0.215 (5.5)	0.250 (6.4)	0.093 (2.4)	.025 (0.6) ± .003 (0.07)	1	100	M71-R4300
Fig. 44	M71-375-1-342YL	Yellow	12 to 4	0.125 (3.2) - 0.320 (8.1)	0.375 (9.5)	0.125 (3.1)	.025 (0.6) ± .003 (0.07)	1	100	M71-R4300
Fig. 44	BM71-500-1-342YL	Yellow	8 to 1	0.187 (4.8) - 0.450 (11.4)	0.500 (12.7)	0.187 (4.7)	.025 (0.6) ± .003 (0.07)	1	1000	M71-R4300
Fig. 44	M71-500-1-342YL	Yellow	8 to 1	0.187 (4.8) - 0.450 (11.4)	0.500 (12.7)	0.187 (4.7)	.025 (0.6) ± .003 (0.07)	1	100	M71-R4300
Fig. 44	M71-1000-1-342YL	Yellow	2 to 0.950 dia.	0.333 (8.5) - 0.950 (24.1)	1.000 (25.4)	0.375 (9.5)	.036 (0.9) ± .003 (0.07)	1	50	M71-R4300
<b>3:1 Shrink ratio single-side printable, 1.75" sleeve width (dimension A):</b>										
Fig. 44	M71-94-175-342	White	28 to 20	0.023 (0.6) - 0.080 (2.0)	0.094 (2.4)	0.024 (0.6)	.024 (0.6) ± .003 (0.07)	1	100	M71-R4300
Fig. 44	BM71-125-175-342	White	22 to 16	0.046 (1.2) - 0.110 (2.8)	0.125 (3.2)	0.047 (1.2)	.020 (0.5) ± .003 (0.07)	1	1000	M71-R4300
Fig. 44	M71-125-175-342	White	22 to 16	0.046 (1.2) - 0.110 (2.8)	0.125 (3.2)	0.047 (1.2)	.020 (0.5) ± .003 (0.07)	1	100	M71-R4300
Fig. 44	BM71-187-175-342	White	20 to 10	0.062 (1.6) - 0.150 (3.8)	0.187 (4.7)	0.062 (1.6)	.020 (0.5) ± .003 (0.07)	1	1000	M71-R4300
Fig. 44	M71-187-175-342	White	20 to 10	0.062 (1.6) - 0.150 (3.8)	0.187 (4.7)	0.062 (1.6)	.020 (0.5) ± .003 (0.07)	1	100	M71-R4300
Fig. 44	BM71-250-175-342	White	16 to 8	0.094 (2.4) - 0.215 (5.5)	0.250 (6.4)	0.093 (2.4)	.025 (0.6) ± .003 (0.07)	1	1000	M71-R4300
Fig. 44	M71-250-175-342	White	16 to 8	0.094 (2.4) - 0.215 (5.5)	0.250 (6.4)	0.093 (2.4)	.025 (0.6) ± .003 (0.07)	1	100	M71-R4300
Fig. 44	BM71-375-175-342	White	12 to 4	0.125 (3.2) - 0.320 (8.1)	0.375 (9.5)	0.125 (3.1)	.025 (0.6) ± .003 (0.07)	1	1000	M71-R4300
Fig. 44	M71-375-175-342	White	12 to 4	0.125 (3.2) - 0.320 (8.1)	0.375 (9.5)	0.125 (3.1)	.025 (0.6) ± .003 (0.07)	1	100	M71-R4300
Fig. 44	BM71-500-175-342	White	8 to 1	0.187 (4.8) - 0.450 (11.4)	0.500 (12.7)	0.187 (4.7)	.025 (0.6) ± .003 (0.07)	1	1000	M71-R4300
Fig. 44	M71-500-175-342	White	8 to 1	0.187 (4.8) - 0.450 (11.4)	0.500 (12.7)	0.187 (4.7)	.025 (0.6) ± .003 (0.07)	1	100	M71-R4300
Fig. 44	BM71-1000-175-342	White	2 to 0.950 dia.	0.333 (8.5) - 0.950 (24.1)	1.000 (25.4)	0.375 (9.5)	.036 (0.9) ± .003 (0.07)	1	500	M71-R4300
Fig. 44	M71-1000-175-342	White	2 to 0.950 dia.	0.333 (8.5) - 0.950 (24.1)	1.000 (25.4)	0.375 (9.5)	.036 (0.9) ± .003 (0.07)	1	50	M71-R4300
Fig. 44	BM71-94-175-342YL	Yellow	28 to 20	0.023 (0.6) - 0.080 (2.0)	0.094 (2.4)	0.024 (0.6)	.024 (0.6) ± .003 (0.07)	1	2500	M71-R4300
Fig. 44	M71-94-175-342YL	Yellow	28 to 20	0.023 (0.6) - 0.080 (2.0)	0.094 (2.4)	0.024 (0.6)	.024 (0.6) ± .003 (0.07)	1	100	M71-R4300
Fig. 44	BM71-125-175-342YL	Yellow	22 to 16	0.046 (1.2) - 0.110 (2.8)	0.125 (3.2)	0.047 (1.2)	.020 (0.5) ± .003 (0.07)	1	1000	M71-R4300
Fig. 44	M71-125-175-342YL	Yellow	22 to 16	0.046 (1.2) - 0.110 (2.8)	0.125 (3.2)	0.047 (1.2)	.020 (0.5) ± .003 (0.07)	1	100	M71-R4300
Fig. 44	BM71-187-175-342YL	Yellow	20 to 10	0.062 (1.6) - 0.150 (3.8)	0.187 (4.7)	0.062 (1.6)	.020 (0.5) ± .003 (0.07)	1	1000	M71-R4300
Fig. 44	M71-187-175-342YL	Yellow	20 to 10	0.062 (1.6) - 0.150 (3.8)	0.187 (4.7)	0.062 (1.6)	.020 (0.5) ± .003 (0.07)	1	100	M71-R4300
Fig. 44	BM71-250-175-342YL	Yellow	16 to 8	0.094 (2.4) - 0.215 (5.5)	0.250 (6.4)	0.093 (2.4)	.025 (0.6) ± .003 (0.07)	1	1000	M71-R4300
Fig. 44	M71-250-175-342YL	Yellow	16 to 8	0.094 (2.4) - 0.215 (5.5)	0.250 (6.4)	0.093 (2.4)	.025 (0.6) ± .003 (0.07)	1	100	M71-R4300
Fig. 44	M71-375-175-342YL	Yellow	12 to 4	0.125 (3.2) - 0.320 (8.1)	0.375 (9.5)	0.125 (3.1)	.025 (0.6) ± .003 (0.07)	1	100	M71-R4300
Fig. 44	BM71-500-175-342YL	Yellow	8 to 1	0.187 (4.8) - 0.450 (11.4)	0.500 (12.7)	0.187 (4.7)	.025 (0.6) ± .003 (0.07)	1	1000	M71-R4300
Fig. 44	M71-500-175-342YL	Yellow	8 to 1	0.187 (4.8) - 0.450 (11.4)	0.500 (12.7)	0.187 (4.7)	.025 (0.6) ± .003 (0.07)	1	100	M71-R4300
Fig. 44	M71-1000-175-342YL	Yellow	2 to 0.950 dia.	0.333 (8.5) - 0.950 (24.1)	1.000 (25.4)	0.375 (9.5)	.036 (0.9) ± .003 (0.07)	1	50	M71-R4300
<b>3:1 Shrink ratio single-side printable, continuous cut-to-length sleeve width (dimension A):</b>										
Fig. 58	BM71C-125-342	White	22 to 16	0.046 (1.2) - 0.110 (2.8)	0.125 (3.2)	0.047 (1.2)	.020 (0.5) ± .003 (0.07)	1 Roll (cont.)		M71-R4300
Fig. 58	BM71C-187-342	White	20 to 10	0.062 (1.6) - 0.150 (3.8)	0.187 (4.7)	0.062 (1.6)	.020 (0.5) ± .003 (0.07)	1 Roll (cont.)		M71-R4300
Fig. 58	BM71C-250-342	White	16 to 8	0.094 (2.4) - 0.215 (5.5)	0.250 (6.4)	0.093 (2.4)	.025 (0.6) ± .003 (0.07)	1 Roll (cont.)		M71-R4300
Fig. 58	BM71C-375-342	White	12 to 4	0.125 (3.2) - 0.320 (8.1)	0.375 (9.5)	0.125 (3.1)	.025 (0.6) ± .003 (0.07)	1 Roll (cont.)		M71-R4300
Fig. 58	BM71C-500-342	White	8 to 1	0.187 (4.8) - 0.450 (11.4)	0.500 (12.7)	0.187 (4.7)	.025 (0.6) ± .003 (0.07)	1 Roll (cont.)		M71-R4300
Fig. 58	BM71C-1000-342	White	2 to 0.950 dia.	0.333 (8.5) - 0.950 (24.1)	1.000 (25.4)	0.375 (9.5)	.036 (0.9) ± .003 (0.07)	1 Roll (cont.)		M71-R4300

\* Approx. wire gauge based on AWG for THHN wire.

## Circuit Board & Component ID Labels (B-423, B-724, B-428, B-727)

Various materials for relays, solenoids, PCB's, electronic components and more.

- **B-423 Polyester Material** - White glossy polyester
- **B-428 Polyester Material** - metallized matte polyester
- **B-724 Polyimide Material** - Amber matte polyimide with permanent adhesive; can survive on the top or bottom side of PCB's through the solder process
- **B-727 Polyimide Material** - white glossy polyimide with permanent adhesive; can survive through the solder process

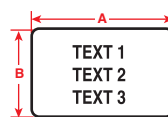

Figure 29

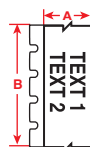

Figure 33



### For Component Labeling

Diagram	Catalog #	B#	Material	Color	Label Width A Inch (mm)	Label Height B Inch (mm)	Labels Per Roll	Rec. Ribbon
<b>B-423 Permanent Polyester Material</b>								
Fig. 29	M71-1-423	B-423	Polyester	White	0.250 (6.350)	0.250 (6.350)	750	M71-R6000
Fig. 29	M71-3-423	B-423	Polyester	White	0.375 (9.530)	0.375 (9.530)	500	M71-R6000
Fig. 29	M71-4-423	B-423	Polyester	White	0.400 (10.160)	0.400 (10.160)	500	M71-R6000
Fig. 33	M71C-500-423	B-423	Polyester	White	0.500 (12.700)	50 ft. (15.24 m)	1 Roll (cont.)	M71-R6000
Fig. 29	M71-5-423	B-423	Polyester	White	0.500 (12.700)	0.200 (5.080)	750	M71-R6000
Fig. 29	M71-6-423	B-423	Polyester	White	0.500 (12.700)	0.280 (6.990)	750	M71-R6000
Fig. 29	BM71-7-423	B-423	Polyester	White	0.500 (12.700)	0.500 (12.700)	5000	M71-R6000
Fig. 29	M71-7-423	B-423	Polyester	White	0.500 (12.700)	0.500 (12.700)	500	M71-R6000
Fig. 29	M71-9-423	B-423	Polyester	White	0.650 (16.510)	0.200 (5.080)	750	M71-R6000
Fig. 29	M71-10-423	B-423	Polyester	White	0.750 (19.050)	0.250 (6.350)	750	M71-R6000
Fig. 29	M71-13-423	B-423	Polyester	White	0.900 (22.860)	0.250 (6.350)	750	M71-R6000
Fig. 29	M71-14-423	B-423	Polyester	White	1.000 (25.400)	0.187 (4.750)	750	M71-R6000
Fig. 29	M71-15-423	B-423	Polyester	White	1.000 (25.400)	0.275 (6.990)	750	M71-R6000
Fig. 29	BM71-16-423	B-423	Polyester	White	1.000 (25.400)	0.375 (9.530)	5000	M71-R6000
Fig. 29	M71-16-423	B-423	Polyester	White	1.000 (25.400)	0.375 (9.530)	500	M71-R6000
Fig. 29	BM71-17-423	B-423	Polyester	White	1.000 (25.400)	0.500 (12.700)	5000	M71-R6000
Fig. 29	M71-17-423	B-423	Polyester	White	1.000 (25.400)	0.500 (12.700)	500	M71-R6000
Fig. 29	BM71-19-423	B-423	Polyester	White	1.000 (25.400)	1.000 (25.400)	2500	M71-R6000
Fig. 29	M71-19-423	B-423	Polyester	White	1.000 (25.400)	1.000 (25.400)	250	M71-R6000
Fig. 29	M71-24-423-BK	B-423	Polyester	Black Border	1.130 (28.700)	0.500 (12.700)	500	M71-R6000
Fig. 29	M71-25-423	B-423	Polyester	White	1.250 (31.750)	0.250 (6.350)	750	M71-R6000
Fig. 29	M71-27-423	B-423	Polyester	White	1.500 (38.100)	0.125 (3.180)	750	M71-R6000
Fig. 29	M71-28-423	B-423	Polyester	White	1.500 (38.100)	0.250 (6.350)	750	M71-R6000
Fig. 29	BM71-29-423	B-423	Polyester	White	1.500 (38.100)	0.500 (12.700)	5000	M71-R6000
Fig. 29	M71-29-423	B-423	Polyester	White	1.500 (38.100)	0.500 (12.700)	500	M71-R6000
Fig. 29	M71-31-423	B-423	Polyester	White	1.500 (38.100)	1.000 (25.400)	250	M71-R6000
Fig. 29	M71-32-423	B-423	Polyester	White	1.500 (38.100)	1.500 (38.100)	250	M71-R6000
Fig. 29	M71-2-423	B-423	Polyester	White	2.000 (50.800)	0.250 (6.350)	100	M71-R6000
Fig. 29	BM71-20-423	B-423	Polyester	White	2.000 (50.800)	1.000 (25.400)	1000	M71-R6000
Fig. 29	M71-20-423	B-423	Polyester	White	2.000 (50.800)	1.000 (25.400)	100	M71-R6000
Fig. 29	M71-26-423	B-423	Polyester	White	2.750 (69.850)	1.250 (31.750)	100	M71-R6000
Fig. 29	M71-22-423	B-423	Polyester	White	3.000 (76.200)	1.000 (25.400)	100	M71-R6000
Fig. 29	M71-37-423	B-423	Polyester	White	3.000 (76.200)	1.900 (48.260)	100	M71-R6000
Fig. 29	M71-23-423	B-423	Polyester	White	4.000 (101.600)	1.000 (25.400)	100	M71-R6000
Fig. 29	M71-38-423	B-423	Polyester	White	4.000 (101.600)	1.900 (48.260)	100	M71-R6000
<b>B-428 Metallized Polyester Material</b>								
Fig. 29	M71-15-428	B-428	Polyester	Silver	1.000 (25.400)	0.275 (6.990)	750	M71-R4300
Fig. 29	BM71-17-428	B-428	Polyester	Silver	1.000 (25.400)	0.500 (12.700)	5000	M71-R4300
Fig. 29	M71-17-428	B-428	Polyester	Silver	1.000 (25.400)	0.500 (12.700)	500	M71-R4300
Fig. 29	M71-29-428	B-428	Polyester	Silver	1.500 (38.100)	0.500 (12.700)	500	M71-R4300
Fig. 29	BM71-20-428	B-428	Polyester	Silver	2.000 (50.800)	1.000 (25.400)	1000	M71-R4300
Fig. 29	M71-20-428	B-428	Polyester	Silver	2.000 (50.800)	1.000 (25.400)	100	M71-R4300
Fig. 29	M71-26-428	B-428	Polyester	White	2.750 (69.850)	1.250 (31.750)	100	M71-R4300
Fig. 29	M71-22-428	B-428	Polyester	Silver	3.000 (76.200)	1.000 (25.400)	100	M71-R4300
Fig. 29	M71-38-428	B-428	Polyester	White	4.000 (101.600)	1.900 (48.260)	100	M71-R4300

### For Circuit Board Labeling

Diagram	Catalog #	B#	Material	Color	Label Width A Inch (mm)	Label Height B Inch (mm)	Labels Per Roll	Rec. Ribbon
<b>B-724 Matte Polyimide Material</b>								
Fig. 29	M71-9-724	B-724	Polyimide	Amber	0.650 (16.510)	0.200 (5.080)	750	M71-R4300
Fig. 29	M71-13-724	B-724	Polyimide	Amber	0.900 (22.860)	0.250 (6.350)	750	M71-R4300
Fig. 29	M71-16-724	B-724	Polyimide	Amber	1.000 (25.400)	0.375 (9.530)	500	M71-R4300
Fig. 29	M71-17-724	B-724	Polyimide	Amber	1.000 (25.400)	0.500 (12.700)	500	M71-R4300
Fig. 29	M71-28-724	B-724	Polyimide	Amber	1.500 (38.100)	0.250 (6.350)	750	M71-R4300
<b>B-727 Glossy Polyimide Material</b>								
Fig. 29	M71-3-727	B-727	Polyimide	White	0.375 (9.530)	0.375 (9.530)	500	M71-R6000
Fig. 29	M71-10-727	B-727	Polyimide	White	0.750 (19.050)	0.250 (6.350)	750	M71-R6000
Fig. 29	M71-16-727	B-727	Polyimide	White	1.000 (25.400)	0.375 (9.530)	500	M71-R6000

See all BMP®71 Print Ribbon parts on page 337.



# BMP<sup>®</sup>71 Label Materials

BradyID.com/bmp71

## Electrostatic Dissipative Labels (B-473, B-717, B-718)

Low profile polyimide and polyester materials that have static dissipative properties. Primarily used for printed circuit boards and electronic component labeling.

- **B-473 Electrostatic Dissipative Polyester Material** - White glossy polyester with a permanent static dissipative adhesive and liner.
- **B-717 Electrostatic Dissipative Polyimide Material** - High temperature white glossy polyimide material (2 mil) with a permanent static dissipative adhesive and liner for PCB identification.
- **B-718 Electrostatic Dissipative Polyimide Material** - High temperature, low profile white glossy polyimide material (1 mil) with a permanent static dissipative adhesive and liner for PCB identification.

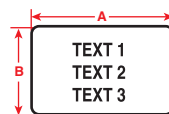

Figure 29

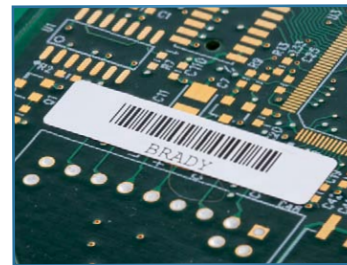

Diagram	Catalog #	B#	Material	Color	Label Width A Inch (mm)	Label Height B Inch (mm)	Labels Per Roll	Rec. Ribbon
<b>B-473 Glossy White Polyester</b>								
Fig. 29	M71-6-473	B-473	Polyester	White	0.500 (12.7)	0.275 (7.0)	750	M71-R6000
Fig. 29	M71-9-473	B-473	Polyester	White	0.650 (16.5)	0.200 (5.1)	750	M71-R6000
Fig. 29	M71-10-473	B-473	Polyester	White	0.750 (19.1)	0.250 (6.4)	750	M71-R6000
Fig. 29	M71-16-473	B-473	Polyester	White	1.000 (25.4)	0.375 (9.5)	500	M71-R6000
Fig. 29	M71-17-473	B-473	Polyester	White	1.000 (25.4)	0.500 (12.7)	500	M71-R6000
Fig. 29	M71-28-473	B-473	Polyester	White	1.500 (38.1)	0.250 (6.4)	750	M71-R6000
<b>B-717 Glossy White Static Dissipative Polyimide</b>								
Fig. 29	M71-14-717	B-717	Polyimide	White	1.000 (25.4)	0.187 (4.8)	750	M71-R6000
Fig. 29	M71-2-717	B-717	Polyimide	White	2.000 (50.8)	0.250 (6.4)	100	M71-R6000
<b>B-718 Glossy White Low Profile Static Dissipative Polyimide</b>								
Fig. 29	M71-4-718	B-718	Polyimide	White	0.400 (10.2)	0.400 (10.2)	500	M71-R6000
Fig. 29	M71-9-718	B-718	Polyimide	White	0.650 (16.5)	0.200 (5.1)	750	M71-R6000
Fig. 29	M71-25-718	B-718	Polyimide	White	1.250 (31.8)	0.250 (6.4)	750	M71-R6000

## Tamper Indicating Labels (B-351, B-352, B-530)

Tamper resistant tape destructs into tiny fragments when being removed. Making any attempts to remove the label very difficult and time consuming.

- **B-351 Destructible Vinyl Material** - White vinyl material with matte finish and permanent adhesive.
- **B-352 Destructible Vinyl Material** - Metallized vinyl material with matte finish and permanent adhesive.
- **B-530 Tamper-Resistant Vinyl Material**

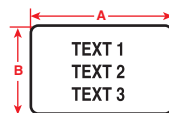

Figure 29



Figure 33

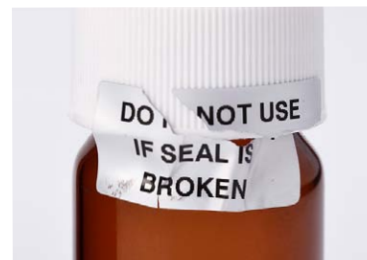

Diagram	Catalog #	B#	Material	Color	Label Width A Inch (mm)	Label Height B Inch (mm)	Labels Per Roll	Rec. Ribbon
<b>B-351 Destructible Vinyl Labels</b>								
Fig. 29	M71-17-351	B-351	Vinyl	White	1.000 (25.4)	0.500 (12.7)	500	M71-R6200
Fig. 29	M71-31-351	B-351	Vinyl	White	1.500 (38.1)	1.000 (25.4)	250	M71-R6200
Fig. 29	M71-20-351	B-351	Vinyl	White	2.000 (50.8)	1.000 (25.4)	100	M71-R6200
Fig. 29	M71-37-351	B-351	Vinyl	White	3.000 (76.2)	1.900 (48.3)	100	M71-R6200
<b>B-352 Destructible Vinyl Labels</b>								
Fig. 29	M71-17-352	B-352	Vinyl	Silver	1.000 (25.4)	0.500 (12.7)	500	M71-R6000
Fig. 29	M71-31-352	B-352	Vinyl	Silver	1.500 (38.1)	1.000 (25.4)	250	M71-R6000
Fig. 29	M71-20-352	B-352	Vinyl	Silver	2.000 (50.8)	1.000 (25.4)	100	M71-R6000
Fig. 29	M71-37-352	B-352	Vinyl	Silver	3.000 (76.2)	1.900 (48.3)	100	M71-R6000
<b>B-530 Tamper-Resistant Vinyl Film</b>								
Fig. 33	M71C-500-530	B-530	Vinyl	White	0.500 (12.7)	50 ft. (15.2 m)	1 Roll (cont.)	M71-R6000
Fig. 33	M71C-1000-530	B-530	Vinyl	White	1.000 (25.4)	50 ft. (15.2 m)	1 Roll (cont.)	M71-R6000
Fig. 33	M71C-2000-530	B-530	Vinyl	White	2.000 (50.8)	50 ft. (15.2 m)	1 Roll (cont.)	M71-R6000



### Did You Know? - Technical Data Sheets

Looking for more information regarding a certain BMP<sup>®</sup>71 Label materials? Brady offers online access to Technical Data Sheets for all Brady materials. View by a specific B-Number or search by relevant keywords. Visit [BradyID.com/techdata](http://BradyID.com/techdata) for more information.



See all BMP<sup>®</sup>71 Print Ribbon parts on page 337.



# BMP®71 Print Ribbons

BradyID.com/bmp71

## BMP®71 Printer Ribbons

Note: Black Ribbon M71-R6000 included with BMP71 printer purchase.

Catalog #	Color	Size
M71-R4300	Black	150' (45.7 m)
M71-R6000	Black	150' (45.7 m)
M71-R6200	Black	150' (45.7 m)
M71-R6400	Black	150' (45.7 m)
M71-R6600	Black	150' (45.7 m)
M71-R4400-WT	White	150' (45.7 m)

Catalog #	Color	Size
M71-R6800-WT	White	120' (36.6 m)
M71-R6900-RD	Red	150' (45.7 m)
M71-R6900-BL	Blue	150' (45.7 m)
M71-R6900-GN	Green	150' (45.7 m)
M71-R6900-MA	Magenta	150' (45.7 m)
M71-R6900-YL	Yellow	150' (45.7 m)



## BMP®71 Print Ribbon / Material Compatibility

B-Number	Material	M71-R4300 (Black)	M71-R6000 (Black)	M71-R6200 (Black)	M71-R6400 (Black)	M71-R6600 (Black)	M71-R4400-WT (White)	M71-R6800-WT (White)	M71-R6900 (Colors)
B-109	Polyethylene Tags	●	-	▲	-	-	-	-	-
B-145	Polyethylene Tags	-	●	▲	-	-	▲	-	-
B-145FR	Polyethylene Tags	-	●	▲	-	-	▲	-	▲
B-321*	Polyolefin	-	-	●	-	-	-	-	-
B-342	PermaSleeve® Polyolefin	●	-	-	-	▲	-	-	-
B-345*	High Temp PermaSleeve®	-	▲	-	-	●	-	▲	-
B-351	Destructible Vinyl	-	▲	●	-	-	-	-	▲
B-352	Destructible Vinyl	-	●	-	-	-	-	-	▲
B-353*	Paper	●	-	-	-	-	-	-	-
B-390*	DuraSleeve® Polypropylene	-	●	-	-	-	-	-	▲
B-412	Polypropylene Tags	▲	-	●	-	-	-	-	-
B-422	Polyester	-	● UL	-	-	-	-	-	▲
B-423	Polyester	-	● UL	▲	-	-	-	-	▲
B-424	Paper	●	-	-	-	-	-	-	▲
B-425	Polypropylene	●	-	▲	-	-	-	-	-
B-427	Vinyl	● UL	-	▲	-	-	-	-	-
B-428	Polyester	● UL	-	▲	-	-	-	-	-
B-430	Polyester	-	● UL	▲	-	-	▲	-	▲
B-432*	Polyester	-	● UL	-	-	-	▲	-	▲
B-433*	Polyester	-	● UL	-	-	-	▲	-	▲
B-435*	Polyester	-	● UL	-	-	-	▲	-	▲
B-439*	Vinyl	-	●	▲	-	-	▲	-	▲
B-459	Polyester	-	● UL	-	-	-	-	-	-
B-472	Polyimide	●	-	▲	-	-	-	-	-
B-473	Polyester	-	● UL	-	-	-	-	-	-
B-483	Polyester	-	● UL	-	-	-	-	-	▲
B-486	Polyester	● UL	-	▲	-	-	-	-	-
B-488	Polyester	● UL	-	▲	-	-	-	-	-
B-489	Polyester	● UL	-	▲	-	-	-	-	-
B-495*	Polyethylene Naphthalate	-	● UL	-	-	-	▲	-	▲
B-498	Vinyl Cloth	▲	▲	●	-	-	-	-	-
B-499	Nylon Cloth	● UL	▲	▲	-	-	-	-	▲
B-529	Polypropylene	-	●	-	-	-	-	-	▲
B-530	Tamper Resistant	-	●	-	-	-	-	-	▲
B-581	Vinyl	-	●	-	-	-	-	-	▲
B-582	Phosphorescent	-	●	-	-	-	▲	-	▲
B-584	Reflective	-	●	-	-	-	▲	-	▲
B-593	Polyester	-	●	-	-	-	▲	-	-
B-595	Vinyl	-	●	-	-	-	▲	-	▲
B-717	Polyimide	-	● UL	-	-	-	-	-	-
B-718	Polyimide	-	● UL	-	-	-	-	-	-
B-719*	Polyimide	-	● UL	-	-	-	-	-	-
B-724	Polyimide	●	-	-	-	-	-	-	-
B-727	Polyimide	-	● UL	-	-	-	-	-	-
B-854	ToughWash™ Metal Detectable	-	●	-	-	-	-	-	-
B-855	ToughWash™ Material	-	●	-	-	-	-	-	-
B-7531*	Metalized Polyester	●	-	-	-	-	-	-	-
B-7536*	Polyester	-	-	●	-	-	-	-	-
B-7546*	Void Footprint Polyester	-	● UL	-	-	-	▲	-	▲
B-7551*	Polyester	-	-	●	-	-	-	-	-
B-7566*	Void Footprint Polyester	-	●	-	-	-	▲	-	▲
B-7576*	Void Footprint Polyester	● UL	-	-	-	-	-	-	-
B-7593*	Polyethelene	-	●	-	-	-	▲	-	▲
B-7596*	Vinyl	-	-	●	-	-	-	-	-
B-7597*	Polyethelene	●	-	-	-	-	-	-	-
B-7599*	Polyethelene Tag	●	-	-	-	-	-	-	-
B-7643*	Thermoplastic Polyether Polyurethane	●	-	-	-	▲	-	▲	-
B-7696*	Vinyl Tag	-	●	-	-	-	▲	-	▲
B-8425*	Polypropylene	-	● UL	-	-	-	-	-	▲

\*Materials available for the TLS®2200 that also work in the BMP®71 Label Printer.  
For more information on Brady materials, visit BradyID.com/techdata.

● Rec. Ribbon for use with respective material.  
▲ Acceptable ribbon for use with respective material.  
UL These materials are UL recognized with its respective ribbon.





The IDXPERT™ printer has been discontinued, but Brady continues to manufacture and stock labels and accessories for the printer!

Catalog #	Description
XPBPT-HC-ABC	Hard Case for ABC Layout
XPBPT-HC-KEY	Hard Case for KEYBOARD Layout
LABXPBPT-SER-USB	Serial-to-USB adapter for PC cable
PCK-6	Cleaning Kit

## Labels for Lean, Facility & Safety ID and General ID. (B-422, B-428, B-483, B-499, B-595)

**B-422 Polyester Material** - Permanent adhesive, good for powder-coated/textured surfaces. Best on flat surfaces. Temp. Range: -40°F to 212°F (-40°C to 100°C). UL recognized.

**B-428 Metallized Polyester Material** - Permanent adhesive, silver finish. Temp. Range: -40°F to 176°F (-40°C to 80°C). UL recognized.

**B-483 Polyester Material** - Permanent adhesive for powder-coated/textured surfaces. Best on flat surfaces. Temp. Range: -40°F to 248°F (-40°C to 120°C). UL recognized.

**B-499 Nylon Cloth Material** - Permanent adhesive. Pliable for rough or smooth surfaces. Temp. Range: -94°F to 194°F (-70°C to 90°C). UL recognized.

**B-595 Indoor/Outdoor Vinyl Material** - Permanent adhesive, very pliable, good for rough surfaces and outdoor use, wide range of colors. Temp. Range: -40°F to 248°F (-40°C to 120°C). UL recognized.

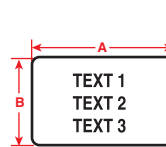

Figure 29



Figure 33

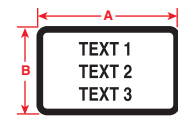

Figure 46  
(Includes black border)

Diagram	Part Number	B#	Material	Color	Label Width A Inch (mm)	Label Height B Inch (mm)	Labels/Roll
<b>B-422 Polyester Labels</b>							
Fig. 29	X-7-422	B-422	Polyester	BK on WT	0.500 (12.7)	0.500 (12.7)	350
Fig. 29	X-19-422	B-422	Polyester	BK on WT	1.000 (25.4)	1.000 (25.4)	250
Fig. 29	X-132-422	B-422	Polyester	BK on WT	1.500 (38.1)	1.250 (13.8)	250
Fig. 29	X-30-422	B-422	Polyester	BK on WT	1.500 (38.1)	0.750 (19.1)	250
<b>B-428 Metallized Polyester Labels</b>							
Fig. 29	X-17-428-SV-BK	B-428	Polyester	BK on SV	1.000 (25.4)	0.500 (12.7)	500
Fig. 46	X-24-428-SVBB-BK	B-428	Polyester	BK on SV	1.130 (28.7)	0.500 (12.7)	500
Fig. 29	X-29-428-SV-BK	B-428	Polyester	BK on SV	1.500 (38.1)	0.500 (12.7)	500
Fig. 29	X-30-428-SV-BK	B-428	Polyester	BK on SV	1.500 (38.1)	0.750 (19.1)	325
Fig. 29	X-20-428-SV-BK	B-428	Polyester	BK on SV	2.000 (50.8)	1.000 (25.4)	100
<b>B-483 Polyester Labels</b>							
Fig. 29	X-17-483	B-483	Polyester	BK on WT	1.000 (25.4)	0.500 (12.7)	500
Fig. 29	X-20-483	B-483	Polyester	BK on WT	2.000 (50.8)	1.000 (25.4)	100
Fig. 29	X-61-483	B-483	Polyester	BK on WT	2.000 (50.8)	0.500 (12.7)	100
<b>B-499 Nylon Cloth Labels Labels</b>							
Fig. 33	XC-375-499	B-499	Nylon Cloth	BK on WT	0.375 (9.5)	20 ft. (6.1 m)	1 roll (cont.)
Fig. 29	X-130-499	B-499	Nylon Cloth	BK on WT	0.375 (9.5)	0.750 (19.1)	300
Fig. 33	XC-500-499	B-499	Nylon Cloth	BK on WT	0.500 (12.7)	20 ft. (6.1 m)	1 roll (cont.)
Fig. 29	X-11-499	B-499	Nylon Cloth	BK on WT	0.750 (19.1)	0.500 (12.7)	275
Fig. 33	XC-750-499	B-499	Nylon Cloth	BK on WT	0.750 (19.1)	20 ft. (6.1 m)	1 roll (cont.)
Fig. 29	X-84-499	B-499	Nylon Cloth	BK on WT	0.900 (22.9)	0.500 (12.7)	250
Fig. 33	XC-1000-499	B-499	Nylon Cloth	BK on WT	1.000 (25.4)	20 ft. (6.1 m)	1 roll (cont.)
Fig. 29	X-162-499	B-499	Nylon Cloth	BK on WT	1.500 (38.1)	0.500 (12.7)	165

General ID labels continued on next page.

## Indoor/Outdoor Vinyl for Lean, Facility & Safety ID and General ID.

Continued from previous page.



Figure 33



Diagram	Catalog #	B#	Material	Color	Label Width A Inch (mm)	Roll Length B Inch (mm)	Labels/Roll	Price
<b>B-595 Indoor/Outdoor Vinyl Film</b>								
Fig. 33	XC-500-595-CL-BK	B-595	Vinyl	BK on CL	0.500 (12.7)	25 ft. (7.6 m)	1 roll (cont.)	\$0.00
Fig. 33	XC-750-595-CL-BK	B-595	Vinyl	BK on CL	0.750 (19.1)	25 ft. (7.6 m)	1 roll (cont.)	\$0.00
Fig. 33	XC-1000-595-CL-BK	B-595	Vinyl	BK on CL	1.000 (25.4)	25 ft. (7.6 m)	1 roll (cont.)	\$0.00
Fig. 33	XC-1500-595-CL-BK	B-595	Vinyl	BK on CL	1.500 (38.1)	25 ft. (7.6 m)	1 roll (cont.)	\$0.00
Fig. 33	XC-500-595-OR-BK	B-595	Vinyl	BK on OR	0.500 (12.7)	30 ft. (9.1 m)	1 roll (cont.)	\$0.00
Fig. 33	XC-750-595-OR-BK	B-595	Vinyl	BK on OR	0.750 (19.1)	30 ft. (9.1 m)	1 roll (cont.)	\$0.00
Fig. 33	XC-1000-595-OR-BK	B-595	Vinyl	BK on OR	1.000 (25.4)	30 ft. (9.1 m)	1 roll (cont.)	\$0.00
Fig. 33	XC-1500-595-OR-BK	B-595	Vinyl	BK on OR	1.500 (38.1)	30 ft. (9.1 m)	1 roll (cont.)	\$0.00
Fig. 33	XC-500-595-WT-BK	B-595	Vinyl	BK on WT	0.500 (12.7)	30 ft. (9.1 m)	1 roll (cont.)	\$0.00
Fig. 33	XC-750-595-WT-BK	B-595	Vinyl	BK on WT	0.750 (19.1)	30 ft. (9.1 m)	1 roll (cont.)	\$0.00
Fig. 33	XC-1000-595-WT-BK	B-595	Vinyl	BK on WT	1.000 (25.4)	30 ft. (9.1 m)	1 roll (cont.)	\$0.00
Fig. 33	XC-1500-595-WT-BK	B-595	Vinyl	BK on WT	1.500 (38.1)	30 ft. (9.1 m)	1 roll (cont.)	\$0.00
Fig. 33	XC-500-595-YL-BK	B-595	Vinyl	BK on YL	0.500 (12.7)	30 ft. (9.1 m)	1 roll (cont.)	\$0.00
Fig. 33	XC-750-595-YL-BK	B-595	Vinyl	BK on YL	0.750 (19.1)	30 ft. (9.1 m)	1 roll (cont.)	\$0.00
Fig. 33	XC-1000-595-YL-BK	B-595	Vinyl	BK on YL	1.000 (25.4)	30 ft. (9.1 m)	1 roll (cont.)	\$0.00
Fig. 33	XC-1500-595-YL-BK	B-595	Vinyl	BK on YL	1.500 (38.1)	30 ft. (9.1 m)	1 roll (cont.)	\$0.00
Fig. 33	XC-500-595-WT-RD	B-595	Vinyl	RD on WT	0.500 (12.7)	30 ft. (9.1 m)	1 roll (cont.)	\$0.00
Fig. 33	XC-750-595-RD-WT	B-595	Vinyl	RD on WT	0.750 (19.1)	30 ft. (9.1 m)	1 roll (cont.)	\$0.00
Fig. 33	XC-1000-595-WT-RD	B-595	Vinyl	RD on WT	1.000 (25.4)	30 ft. (9.1 m)	1 roll (cont.)	\$0.00
Fig. 33	XC-1500-595-WT-RD	B-595	Vinyl	RD on WT	1.500 (38.1)	30 ft. (9.1 m)	1 roll (cont.)	\$0.00
Fig. 33	XC-500-595-BL-WT	B-595	Vinyl	WT on BL	0.500 (12.7)	30 ft. (9.1 m)	1 roll (cont.)	\$0.00
Fig. 33	XC-750-595-BL-WT	B-595	Vinyl	WT on BL	0.750 (19.1)	30 ft. (9.1 m)	1 roll (cont.)	\$0.00
Fig. 33	XC-1000-595-BL-WT	B-595	Vinyl	WT on BL	1.000 (25.4)	30 ft. (9.1 m)	1 roll (cont.)	\$0.00
Fig. 33	XC-1500-595-BL-WT	B-595	Vinyl	WT on BL	1.500 (38.1)	30 ft. (9.1 m)	1 roll (cont.)	\$0.00
Fig. 33	XC-500-595-GN-WT	B-595	Vinyl	WT on GN	0.500 (12.7)	30 ft. (9.1 m)	1 roll (cont.)	\$0.00
Fig. 33	XC-750-595-GN-WT	B-595	Vinyl	WT on GN	0.750 (19.1)	30 ft. (9.1 m)	1 roll (cont.)	\$0.00
Fig. 33	XC-1000-595-GN-WT	B-595	Vinyl	WT on GN	1.000 (25.4)	30 ft. (9.1 m)	1 roll (cont.)	\$0.00
Fig. 33	XC-1500-595-GN-WT	B-595	Vinyl	WT on GN	1.500 (38.1)	30 ft. (9.1 m)	1 roll (cont.)	\$0.00
Fig. 33	XC-500-595-RD-WT	B-595	Vinyl	WT on RD	0.500 (12.7)	30 ft. (9.1 m)	1 roll (cont.)	\$0.00
Fig. 33	XC-750-595-WT-RD	B-595	Vinyl	WT on RD	0.750 (19.1)	30 ft. (9.1 m)	1 roll (cont.)	\$0.00
Fig. 33	XC-1000-595-RD-WT	B-595	Vinyl	WT on RD	1.000 (25.4)	30 ft. (9.1 m)	1 roll (cont.)	\$0.00
Fig. 33	XC-1500-595-RD-WT	B-595	Vinyl	WT on RD	1.500 (38.1)	30 ft. (9.1 m)	1 roll (cont.)	\$0.00

## PermaSleeve® PS Polyolefin Wire Marking Sleeves (B-342)

3:1 heat shrinkable sleeve fits snugly around wire for identification and protection. Fade resistant and flame retardant. Meets the following material and physical property specifications.

- SAE-AMS-DTL-23053/5 (Class 1)
- SAE-AS-81531
- MIL-STD-202
- RoHS Compliant
- UL Recognized
- Tested per: ASTM E162 and ASTM E662

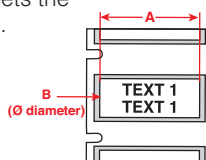

Figure 44

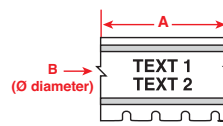

Figure 58



Diagram	Part Number	B#	Color	Approx. Wire Gauge*	Range of Wire Dia. Inch (mm) Min. Max.	Sleeve Width A Inch (mm)	Supplied Diameter B Inch (mm)	Recovered Diameter Inch (mm)	Recovered Wall Thickness Inch (mm)	Sleeves per Roll
<b>B-342 PermaSleeve® PS Polyolefin Wire Marking Sleeves</b>										
Fig. 44	XPS-125-1	B-342	BK on WT	22 to 16	0.046 (1.2) - 0.110 (2.8)	1.015 (25.8)	0.125 (3.2)	0.047 (1.2)	.020 (0.5) ± .003 (0.07)	100
Fig. 58	XPS-125-CONT	B-342	BK on WT	22 to 16	0.046 (1.2) - 0.110 (2.8)	8 ft (2.45m)	0.125 (3.2)	0.047 (1.2)	.020 (0.5) ± .003 (0.07)	1 roll (cont.)
Fig. 58	XPS-125-CONT-YL-BK	B-342	BK on YL	22 to 16	0.046 (1.2) - 0.110 (2.8)	8 ft (2.45m)	0.125 (3.2)	0.047 (1.2)	.020 (0.5) ± .003 (0.07)	1 roll (cont.)
Fig. 44	XPS-187-1	B-342	BK on WT	20 to 10	0.062 (1.6) - 0.150 (3.8)	1.015 (25.8)	0.187 (4.7)	0.062 (1.6)	.020 (0.5) ± .003 (0.07)	100
Fig. 58	XPS-187-CONT	B-342	BK on WT	20 to 10	0.062 (1.6) - 0.150 (3.8)	8 ft (2.45m)	0.187 (4.7)	0.062 (1.6)	.020 (0.5) ± .003 (0.07)	1 roll (cont.)
Fig. 58	XPS-187-CONT-YL-BK	B-342	BK on YL	20 to 10	0.062 (1.6) - 0.150 (3.8)	8 ft (2.45m)	0.187 (4.7)	0.062 (1.6)	.020 (0.5) ± .003 (0.07)	1 roll (cont.)
Fig. 44	XPS-250-1	B-342	BK on WT	16 to 8	0.094 (2.4) - 0.215 (5.5)	1.015 (25.8)	0.250 (6.4)	0.093 (2.4)	.025 (0.6) ± .003 (0.07)	100
Fig. 58	XPS-250-CONT	B-342	BK on WT	16 to 8	0.094 (2.4) - 0.215 (5.5)	8 ft (2.45m)	0.250 (6.4)	0.093 (2.4)	.025 (0.6) ± .003 (0.07)	1 roll (cont.)
Fig. 58	XPS-250-CONT-YL-BK	B-342	BK on YL	16 to 8	0.094 (2.4) - 0.215 (5.5)	8 ft (2.45m)	0.250 (6.4)	0.093 (2.4)	.025 (0.6) ± .003 (0.07)	1 roll (cont.)
Fig. 44	XPS-375-1	B-342	BK on WT	12 to 4	0.125 (3.2) - 0.320 (8.13)	1.015 (25.8)	0.375 (9.5)	0.125 (3.1)	.025 (0.6) ± .003 (0.07)	100
Fig. 58	XPS-375-CONT	B-342	BK on WT	12 to 4	0.125 (3.2) - 0.320 (8.13)	8 ft (2.45m)	0.375 (9.5)	0.125 (3.1)	.025 (0.6) ± .003 (0.07)	1 roll (cont.)



## Repositionable Vinyl Cloth Wire & Cable Wraps (B-498)

Printer automatically repeats your text to fill the label for maximum readability. Special adhesive stays put, but marker can be removed and reapplied if necessary. Temp Range -40°F to 175°F (-40°C to 70°C). UL Recognized.

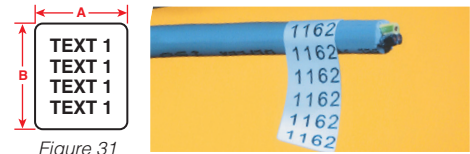

Figure 31

Diagram	Catalog #	B#	Material	Color	Approx. Wire Gauge*	Max Wire Dia. Inch (mm)	Label Width A Inch (mm)	Label Height B Inch (mm)	Labels/Roll
<b>B-498 Repositionable Vinyl Cloth Labels</b>									
Fig. 31	X-7-498	B-498	Vinyl Cloth	BK on WT	22-16	0.11 (2.8)	0.500 (12.7)	0.500 (12.7)	300
Fig. 31	X-11-498	B-498	Vinyl Cloth	BK on WT	16-10	0.16 (4.0)	0.500 (12.7)	0.750 (19.1)	275
Fig. 31	X-163-498	B-498	Vinyl Cloth	BK on WT	12-10	0.21 (5.3)	0.500 (12.7)	1.000 (25.4)	225
Fig. 31	X-19-498	B-498	Vinyl Cloth	BK on WT	12-10	0.21 (5.3)	1.000 (25.4)	1.000 (25.4)	200
Fig. 31	X-18-498	B-498	Vinyl Cloth	BK on WT	12-10	0.21 (5.3)	0.750 (19.1)	1.000 (25.4)	225
Fig. 31	X-103-498	B-498	Vinyl Cloth	BK on WT	10-4	0.27 (6.9)	1.000 (25.4)	1.250 (31.8)	200
Fig. 31	X-162-498	B-498	Vinyl Cloth	BK on WT	10-4	0.32 (6.9)	0.500 (12.7)	1.500 (38.1)	165
Fig. 31	X-31-498	B-498	Vinyl Cloth	BK on WT	10-4	0.32 (6.9)	1.000 (25.4)	1.500 (38.1)	165
Fig. 31	X-21-498	B-498	Vinyl Cloth	BK on WT	3 Gauge - 2/0	0.53 (13.5)	1.000 (25.4)	2.500 (63.5)	95
Fig. 31	X-23-498	B-498	Vinyl Cloth	BK on WT	3/0 - 400Kcmil	0.85 (21.6)	1.000 (25.4)	4.000 (101.6)	60

\*Approx. wire gauge based on AWG for THHN wire.

## Self-Laminating Vinyl Wire & Cable Markers (B-427)

Marker features a clear, non-printed area which wraps around and overlaminates the printed text. Printer automatically repeats your lines of text to fill the white print area. Resistant to abrasion, water, oil and solvents. Temp range -40°F to 158°F (-40°C to 70°C), UL recognized



Figure 32

### Self-Laminating Wire Markers

Diagram	Catalog #	B#	Material	Color	Approx. Wire Gauge*	Max Wire Dia. Inch (mm)	Label Width A Inch (mm)	Label Height B Inch (mm)	Print-On Height C Inch (mm)	Labels/Roll
<b>B-427 Self-Laminating Vinyl Labels</b>										
Fig. 32	XSL-11-427	B-427	Vinyl	BK on WT	16-10	0.160 (4.0)	0.500 (12.7)	0.750 (19.1)	0.375 (9.5)	450
Fig. 32	XSL-96-427	B-427	Vinyl	BK on WT	16-10	0.160 (4.0)	1.000 (25.4)	0.750 (19.1)	0.375 (9.5)	250
Fig. 32	XSL-17-427	B-427	Vinyl	BK on WT	12-10	0.210 (5.3)	0.500 (12.7)	1.000 (25.4)	0.375 (9.5)	450
Fig. 32	XSL-18-427	B-427	Vinyl	BK on WT	12-10	0.210 (5.3)	0.750 (19.1)	1.000 (25.4)	0.375 (9.5)	250
Fig. 32	XSL-19-427	B-427	Vinyl	BK on WT	12-10	0.210 (5.3)	1.000 (25.4)	1.000 (25.4)	0.375 (9.5)	250
Fig. 32	XSL-102-427	B-427	Vinyl	BK on WT	10-4	0.270 (6.9)	0.500 (12.7)	1.250 (31.8)	0.375 (9.5)	250
Fig. 32	XSL-103-427	B-427	Vinyl	BK on WT	10-4	0.270 (6.9)	1.000 (25.4)	1.250 (31.8)	0.500 (12.7)	250
Fig. 32	XSL-115-427	B-427	Vinyl	BK on WT	10-4	0.270 (6.9)	1.500 (38.1)	1.250 (31.8)	0.500 (12.7)	250
Fig. 32	XSL-29-427	B-427	Vinyl	BK on WT	10-4	0.320 (8.1)	0.500 (12.7)	1.500 (38.1)	0.500 (12.7)	450
Fig. 32	XSL-30-427	B-427	Vinyl	BK on WT	10-4	0.320 (8.1)	0.750 (19.1)	1.500 (38.1)	0.500 (12.7)	250
Fig. 32	XSL-31-427	B-427	Vinyl	BK on WT	10-4	0.320 (8.1)	1.000 (25.4)	1.500 (38.1)	0.500 (12.7)	250
Fig. 32	XSL-31-427-YL-BK	B-427	Vinyl	BK on YL	10-4	0.320 (8.1)	1.000 (25.4)	1.500 (38.1)	0.500 (12.7)	250
Fig. 32	XSL-32-427	B-427	Vinyl	BK on WT	10-4	0.320 (8.1)	1.500 (38.1)	1.500 (38.1)	0.500 (12.7)	227
Fig. 32	XSL-21-427-YL-BK	B-427	Vinyl	BK on YL	3 Gauge-2/0	0.530 (13.5)	1.000 (25.4)	2.500 (63.5)	0.750 (19.1)	100
Fig. 32	XSL-21-427	B-427	Vinyl	BK on WT	3 Gauge-2/0	0.530 (13.5)	1.000 (25.4)	2.500 (63.5)	0.750 (19.1)	100
Fig. 32	XSL-116-427	B-427	Vinyl	BK on WT	3 Gauge-2/0	0.530 (13.5)	1.500 (38.1)	2.500 (63.5)	0.750 (19.1)	100
Fig. 32	XSL-23-427	B-427	Vinyl	BK on WT	3/0-400 kcmil	0.850 (22.0)	1.000 (25.4)	4.000 (101.6)	1.000 (25.4)	85
Fig. 32	XSL-23-427-YL-BK	B-427	Vinyl	BK on YL	3/0-400 kcmil	0.850 (22.0)	1.000 (25.4)	4.000 (101.6)	1.000 (25.4)	100
Fig. 32	XSL-33-427	B-427	Vinyl	BK on WT	3/0-400 kcmil	0.850 (22.0)	1.500 (38.1)	4.000 (101.6)	1.000 (25.4)	85
Fig. 32	XSL-34-427	B-427	Vinyl	BK on WT	500-900 kcmil	1.30 (33.0)	1.500 (38.1)	6.000 (152.4)	1.500 (38.1)	50

### Self-Laminating Voice and Data Comm Cable Markers

Diagram	Catalog #	B#	Material	Color	Sized To Fit	Label Width A Inch (mm)	Label Height B Inch (mm)	Print-On Height C Inch (mm)	Labels/Roll
<b>B-427 Self-Laminating Vinyl Labels</b>									
Fig. 32	XSL-19-427	B-427	Vinyl	BK on WT	2 pair Fiber/Coaxial, Single/Multi Mode	1.000 (25.4)	1.000 (25.4)	0.375 (9.5)	250
Fig. 32	XSL-102-427	B-427	Vinyl	BK on WT	CAT-5, 4 pair UTP Copper	0.500 (12.7)	1.250 (31.8)	0.375 (9.5)	250
Fig. 32	XSL-103-427	B-427	Vinyl	BK on WT	CAT-5, 4 pair UTP Copper, Fiber, Coaxial	1.000 (25.4)	1.250 (31.8)	0.500 (12.7)	250
Fig. 32	XSL-115-427	B-427	Vinyl	BK on WT	CAT-5, 4 pair UTP Copper	1.500 (38.1)	1.250 (31.8)	0.500 (12.7)	250
Fig. 32	XSL-29-427	B-427	Vinyl	BK on WT	CAT-5, 4 pair UTP Copper	0.500 (12.7)	1.500 (38.1)	0.500 (12.7)	500
Fig. 32	XSL-30-427	B-427	Vinyl	BK on WT	CAT-5, 4 pair UTP Copper	0.750 (19.1)	1.500 (38.1)	0.500 (12.7)	250
Fig. 32	XSL-31-427	B-427	Vinyl	BK on WT	CAT-5, 4 pair UTP Copper, Fiber, Coaxial	1.000 (25.4)	1.500 (38.1)	0.500 (12.7)	250
Fig. 32	XSL-31-427-YL-BK	B-427	Vinyl	BK on YL	CAT-5, 4 pair UTP Copper, Fiber, Coaxial	1.000 (25.4)	1.500 (38.1)	0.500 (12.7)	250
Fig. 32	XSL-32-427	B-427	Vinyl	BK on WT	CAT-5, 4 pair UTP Copper, Fiber, Coaxial	1.500 (38.1)	1.500 (38.1)	0.500 (12.7)	250
Fig. 32	XSL-21-427	B-427	Vinyl	BK on WT	25 pair Copper, 4-12 pair Fiber, Coaxial	1.000 (25.4)	2.500 (63.5)	0.750 (19.1)	100
Fig. 32	XSL-21-427-YL-BK	B-427	Vinyl	BK on YL	25 pair Copper, 4-12 pair Fiber, Coaxial	1.000 (25.4)	2.500 (63.5)	0.750 (19.1)	100
Fig. 32	XSL-116-427	B-427	Vinyl	BK on WT	25 pair Copper, 4-12 pair Fiber, Coaxial	1.500 (38.1)	2.500 (63.5)	0.750 (19.1)	100
Fig. 32	XSL-23-427	B-427	Vinyl	BK on WT	50 pair Copper, 24 pair Fiber, Backbone	1.000 (25.4)	4.000 (101.6)	1.000 (25.4)	100
Fig. 32	XSL-23-427-YL-BK	B-427	Vinyl	BK on YL	50 pair Copper, 24 pair Fiber, Backbone	1.000 (25.4)	4.000 (101.6)	1.000 (25.4)	100
Fig. 32	XSL-33-427	B-427	Vinyl	BK on WT	50 pair Copper, 24 pair Fiber, Backbone	1.500 (38.1)	4.000 (101.6)	1.000 (25.4)	100
Fig. 32	XSL-34-427	B-427	Vinyl	BK on WT	100 pair Copper, 36 pair Fiber, Backbone	1.500 (38.1)	6.000 (152.4)	1.500 (38.1)	50

## Terminal Repositionable Vinyl Cloth Material (B-498)

Specially designed narrow-width markers automatically set to fixed spacing and separation between leg ends and automatically rotate to top-down orientation for perfect alignment on terminal blocks. Temp Range -40°F to 175°F (-40°C to 80°C), UL Recognized

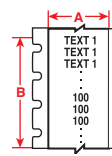

Figure 30

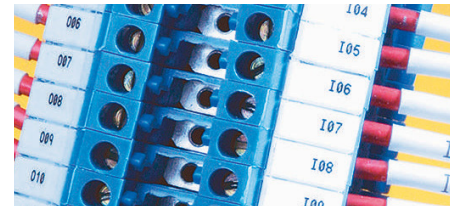

Diagram	Catalog #	B#	Material	Color	Width of Strip Inch (mm)	Label Width A Inch (mm)	Roll Length B Inch (mm)	Labels/Roll
<b>B-498 Repositionable Vinyl Cloth Labels</b>								
Fig. 30	XC-240-498	B-498	Vinyl Cloth	BK on WT	0.240 (6.1) wide	0.240 (6.1)	20 ft. (7.9 m)	1 roll (cont.)
Fig. 30	XC-318-498	B-498	Vinyl Cloth	BK on WT	0.318 (8.1) wide	0.318 (8.1)	20 ft. (7.9 m)	1 roll (cont.)
Fig. 30	XC-375-498	B-498	Vinyl Cloth	BK on WT	0.375 (9.5) wide	0.375 (9.5)	20 ft. (7.9 m)	1 roll (cont.)

## Polyester Labels (B-422)

Permanent adhesive, good for powder-coated/textured surfaces making it ideal for pat panels, outlets and faceplate identification. Best on flat surfaces. Temp. Range: -40°F to 212°F (-40°C to 100°C). UL recognized.

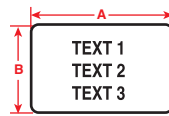

Figure 29

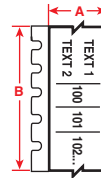

Figure 59

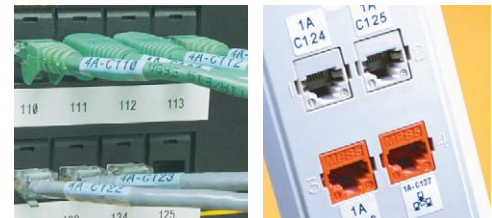

Diagram	Catalog #	B#	Material	Color	Sized To Fit	Label Width A Inch (mm)	Label Height B Inch (mm)	Labels/Roll
<b>B-422 Polyester Labels</b>								
Fig. 59	XC-375-422	B-422	Polyester	BK on WT	Label Punch Blocks or Multiple Ports on Cont. Tape	0.375 (9.530)	30 ft. (9.140 m)	1 roll (cont.)
Fig. 59	XC-475-422	B-422	Polyester	BK on WT	Label Punch Blocks or Multiple Ports on Cont. Tape	0.475 (12.070)	30 ft. (9.140 m)	1 roll (cont.)
Fig. 29	X-7-422	B-422	Polyester	BK on WT	Label Each Port	0.500 (12.700)	0.500 (12.700)	350
Fig. 29	X-17-422	B-422	Polyester	BK on WT	Label Faceplate	1.000 (25.400)	0.500 (12.700)	500
Fig. 29	X-29-422	B-422	Polyester	BK on WT	Label Faceplate	1.500 (38.100)	0.500 (12.700)	500

## Racks, Bays, Frames, Public Network & Data Center ID (B-422, B-483, B-595)

**B-422 Polyester Material** - Permanent adhesive, good for powder-coated/textured surfaces. Best on flat surfaces. Temp. Range: -40°F to 212°F (-40°C to 100°C). UL recognized.

**B-483 Polyester Material** - Permanent adhesive for powder-coated/textured surfaces. Best on flat surfaces Temp. Range: -40°F to 248°F (-40°C to 120°C). UL recognized.

**B-595 Indoor/Outdoor Vinyl Material** - Permanent adhesive, very pliable, good for rough surfaces and outdoor use, wide range of colors. Temp. Range: -40°F to 248°F (-40°C to 120°C). UL recognized.

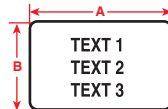

Figure 29



Figure 33



Diagram	Catalog #	B#	Material	Color	Label Width A Inch (mm)	Label Height B Inch (mm)	Labels/Roll
<b>B-422 Polyester Labels</b>							
Fig. 29	X-17-422	B-422	Polyester	BK on WT	1.000 (25.4)	0.500 (12.7)	500
Fig. 29	X-29-422	B-422	Polyester	BK on WT	1.500 (38.1)	0.500 (12.7)	500
Fig. 29	X-30-422	B-422	Polyester	BK on WT	1.500 (38.1)	0.750 (19.1)	250
Fig. 29	X-19-422	B-422	Polyester	BK on WT	1.000 (25.4)	1.000 (25.4)	250
Fig. 33	XC-1000-422	B-422	Polyester	BK on WT	1.000 (25.4)	30 ft. (9.1 m)	1 roll (cont.)
<b>B-483 Polyester Labels</b>							
Fig. 29	X-17-483	B-483	Polyester	BK on WT	1.000 (25.4)	0.500 (12.7)	500
Fig. 29	X-61-483	B-483	Polyester	BK on WT	2.000 (50.8)	0.500 (12.7)	100
Fig. 29	X-20-483	B-483	Polyester	BK on WT	2.000 (50.8)	1.000 (25.4)	100
<b>B-595 Indoor/Outdoor Vinyl Film</b>							
Fig. 33	XC-500-595-YL-BK	B-595	Vinyl	BK on YL*	0.500 (12.7)	30 ft. (9.1 m)	1 roll (cont.)
Fig. 33	XC-1000-595-YL-BK	B-595	Vinyl	BK on YL*	1.000 (25.4)	30 ft. (9.1 m)	1 roll (cont.)
Fig. 33	XC-1500-595-YL-BK	B-595	Vinyl	BK on YL*	1.500 (38.1)	30 ft. (9.1 m)	1 roll (cont.)

\*Red, Orange, Green, Blue, White, and Clear are also available on page 339.





**The HandiMark® Printer has been discontinued but Brady continues to manufacture and stock labels and accessories for the HandiMark® Portable Label Maker!**

### HandiMark® Printer Accessories

Catalog #	Description
TLSHM-QUICKCH	HandiMark Quick Charger
42007	Standard Battery Charger
42073	Super Charge (Quick charger and spare battery)
42072	Mega Charge (Quick charger, spare battery and AC Power Supply)
42009	Alcohol Cleaning Strips (5 per pkg.)
42004	PC Connecting Cable

US Patent Numbers: 5,918,989; 5,951,177; 6,113,293; 6,142,686; D409,230

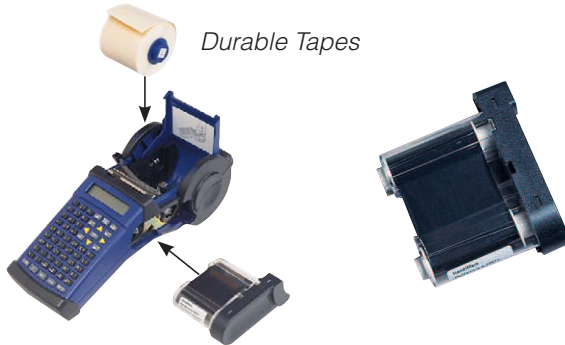

Durable Tapes

Easy to load ribbons

### HandiMark® Print Ribbons

Super-tough, smear-proof, easy-to-load ribbons last for years outdoors.

Catalog #	Size	Color
42011	2" x 75' (51 mm x 23 m)	Black
42012	2" x 75' (51 mm x 23 m)	White
42013	2" x 75' (51 mm x 23 m)	Red
42014	2" x 75' (51 mm x 23 m)	Blue
42015	2" x 75' (51 mm x 23 m)	Green
42123	2" x 65' (51 mm x 20 m)	Yellow
42016	2" x 75' (51 mm x 23 m)	Magenta



### Outdoor Grade Vinyl Tape (B-595)

Labels adhere well to pipes, walls, equipment, doors and most clean, dry surfaces. Withstands temperatures from 180°F to -40°F

Catalog #	B-#	Color	Label Width Inch (mm)	Roll Length Inch (mm)	Labels Per Roll
142269	B-595	White	0.500 (13.0)	50 ft. (15.2 m)	1 Roll (cont.)
142270	B-595	White	1.000 (25.0)	50 ft. (15.2 m)	1 Roll (cont.)
142271	B-595	White	2.000 (51.2)	50 ft. (15.2 m)	1 Roll (cont.)
142272	B-595	Yellow	0.500 (13.0)	50 ft. (15.2 m)	1 Roll (cont.)
142273	B-595	Yellow	1.000 (25.0)	50 ft. (15.2 m)	1 Roll (cont.)
142274	B-595	Yellow	2.000 (51.2)	50 ft. (15.2 m)	1 Roll (cont.)
142287	B-595	Black	0.500 (13.0)	50 ft. (15.2 m)	1 Roll (cont.)
142288	B-595	Black	1.000 (25.0)	50 ft. (15.2 m)	1 Roll (cont.)
142289	B-595	Black	2.000 (51.2)	50 ft. (15.2 m)	1 Roll (cont.)
142281	B-595	Blue	0.500 (13.0)	50 ft. (15.2 m)	1 Roll (cont.)
142282	B-595	Blue	1.000 (25.0)	50 ft. (15.2 m)	1 Roll (cont.)
142283	B-595	Blue	2.000 (51.2)	50 ft. (15.2 m)	1 Roll (cont.)
142302	B-595	Clear	0.500 (13.0)	50 ft. (15.2 m)	1 Roll (cont.)
142303	B-595	Clear	1.000 (25.0)	50 ft. (15.2 m)	1 Roll (cont.)
142304	B-595	Clear	2.000 (51.2)	50 ft. (15.2 m)	1 Roll (cont.)
142296	B-595	Gold	0.500 (13.0)	50 ft. (15.2 m)	1 Roll (cont.)
142297	B-595	Gold	1.000 (25.0)	50 ft. (15.2 m)	1 Roll (cont.)
142298	B-595	Gold	2.000 (51.2)	50 ft. (15.2 m)	1 Roll (cont.)
142275	B-595	Green	0.500 (13.0)	50 ft. (15.2 m)	1 Roll (cont.)
142276	B-595	Green	1.000 (25.0)	50 ft. (15.2 m)	1 Roll (cont.)
142277	B-595	Green	2.000 (51.2)	50 ft. (15.2 m)	1 Roll (cont.)
142290	B-595	Gray	0.500 (13.0)	50 ft. (15.2 m)	1 Roll (cont.)
142291	B-595	Gray	1.000 (25.0)	50 ft. (15.2 m)	1 Roll (cont.)
142292	B-595	Gray	2.000 (51.2)	50 ft. (15.2 m)	1 Roll (cont.)
142284	B-595	Orange	0.500 (13.0)	50 ft. (15.2 m)	1 Roll (cont.)
142285	B-595	Orange	1.000 (25.0)	50 ft. (15.2 m)	1 Roll (cont.)
142286	B-595	Orange	2.000 (51.2)	50 ft. (15.2 m)	1 Roll (cont.)
142278	B-595	Red	0.500 (13.0)	50 ft. (15.2 m)	1 Roll (cont.)
142279	B-595	Red	1.000 (25.0)	50 ft. (15.2 m)	1 Roll (cont.)
142280	B-595	Red	2.000 (51.2)	50 ft. (15.2 m)	1 Roll (cont.)

## Reflective Tape (B-584)

- Suitable for indoor or outdoor use
- Reflective capabilities ideal for reading labels in low light conditions with a flashlight or from a vehicle
- Ideal for utility pole and box labeling, door or rooftop equipment labeling and labels that need to be viewed from a road side



Catalog #	B-#	Color	Label Width Inch (mm)	Roll Length Inch (mm)	Labels Per Roll
42062	B-584	Reflective Silver	1.000 (25.0)	30 ft. (9.14 m)	1 Roll (cont.)
42063	B-584	Reflective Silver	2.000 (51.0)	30 ft. (9.14 m)	1 Roll (cont.)
42066	B-584	Reflective Orange	1.000 (25.0)	30 ft. (9.14 m)	1 Roll (cont.)
42067	B-584	Reflective Orange	2.000 (51.0)	30 ft. (9.14 m)	1 Roll (cont.)
42064	B-584	Reflective Yellow	1.000 (25.0)	30 ft. (9.14 m)	1 Roll (cont.)
42065	B-584	Reflective Yellow	2.000 (51.0)	30 ft. (9.14 m)	1 Roll (cont.)

## Repositionable Vinyl Tape (B-581)

- Vinyl tape has a special adhesive that allows easy removal of label to reapply again...and again
- Best choice for indoor marking where frequent repositioning is required, such as shelves



Catalog #	B-#	Color	Label Width Inch (mm)	Roll Length Inch (mm)	Labels Per Roll
42100	B-581	White	0.500 (13.0)	50 ft. (15.2 m)	1 Roll (cont.)
42101	B-581	White	1.000 (25.0)	50 ft. (15.2 m)	1 Roll (cont.)
42102	B-581	White	2.000 (51.0)	50 ft. (15.2 m)	1 Roll (cont.)
42103	B-581	Yellow	0.500 (13.0)	50 ft. (15.2 m)	1 Roll (cont.)
42104	B-581	Yellow	1.000 (25.0)	50 ft. (15.2 m)	1 Roll (cont.)
42105	B-581	Yellow	2.000 (51.0)	50 ft. (15.2 m)	1 Roll (cont.)

## Economy Polypropylene Tape (B-529)

- Ideal, low-cost label
- For use indoors on smooth, flat surfaces



Catalog #	B-#	Color	Label Width Inch (mm)	Roll Length Inch (mm)	Labels Per Roll
42068	B-529	White	0.500 (13.0)	50 ft. (15.2 m)	1 Roll (cont.)
42069	B-529	White	1.000 (25.0)	50 ft. (15.2 m)	1 Roll (cont.)
42071	B-529	White	2.000 (51.0)	50 ft. (15.2 m)	1 Roll (cont.)

## Tamper Resistant Tape (B-530)

- Tape destructs into tiny fragments when tampered with, making removal very tedious and difficult



Catalog #	B-#	Color	Label Width Inch (mm)	Roll Length Inch (mm)	Labels Per Roll
42137	B-530	White	0.500 (13.0)	50 ft. (15.2 m)	1 Roll (cont.)
42138	B-530	White	1.000 (25.0)	50 ft. (15.2 m)	1 Roll (cont.)
42139	B-530	White	2.000 (51.0)	50 ft. (15.2 m)	1 Roll (cont.)

## Did You Know? The BMP®71 Label Printer

Have you checked out the next generation of Brady printers? With the BMP®71 Label Printer the best features and functionalities of Brady's portable label printers are now combined into one easy-to-use, top-of-the-line portable thermal transfer printer

Visit [BradyID.com/bmp71](http://BradyID.com/bmp71) for more information.



# I.D. PRO® Plus Materials

BradyID.com/s34



**The ID Pro® Plus Printer has been discontinued but Brady continues to manufacture and stock labels, sleeves and accessories for the I.D. Pro™ Plus Printer!**

## I.D. PRO® Plus Printer Accessories

Catalog #	Description
IDPRO-HC	Hard Side Carrying Case
IDPRO-BP	Battery Pack
IDPRO-BC	Battery Charger
R5300	Black High-Performance Ribbon for PermaSleeve™ and DuraSleeve™
R7300	Black High-Performance Ribbon for all labels and BradySleeve™ (Lighter Print more Smear resistant)



U.S Patent Number D409,230

Portable Printers

## Adhesive Wire Marking Labels

- Labels are designed for use with the I.D. Pro™ Plus Portable Printer
- Highly durable and easily visible; perfect for all your on-site label or wire marking applications



Catalog #	Material	Approx. Wire Gauge	Label Width Inch (mm)	Label Height Inch (mm)	Max. Lines of Print	Max. Characters Across Large	Max. Characters Across Small	Labels Per Roll
WML-305-499	Nylon Cloth, Permanent Adhesive	16-22	0.500 (12.7)	0.500 (12.7)	3	3	4	500
WML-305-502	General-Purpose Vinyl Cloth	16-22	0.500 (12.7)	0.500 (12.7)	3	3	4	500
WML-505-499	Nylon Cloth, Permanent Adhesive	10-16	0.500 (12.7)	0.750 (19.05)	4	3	4	250
WML-505-502	General-Purpose Vinyl Cloth	10-16	0.500 (12.7)	0.750 (19.05)	4	3	4	250
WML-511-499	Nylon Cloth, Permanent Adhesive	10-16	1.000 (25.4)	0.750 (19.05)	4	7	10	250
WML-511-502	General-Purpose Vinyl Cloth	10-16	1.000 (25.4)	0.750 (19.05)	4	7	10	250
WML-705-499	Nylon Cloth, Permanent Adhesive	10-12	0.500 (12.7)	1.000 (25.4)	6	3	4	250
WML-705-502	General-Purpose Vinyl Cloth	10-12	0.500 (12.7)	1.000 (25.4)	6	3	4	250
WML-711-499	Nylon Cloth, Permanent Adhesive	10-12	1.000 (25.4)	1.000 (25.4)	6	7	10	250
WML-711-502	General-Purpose Vinyl Cloth	10-12	1.000 (25.4)	1.000 (25.4)	6	7	10	250
WML-905-502	General-Purpose Vinyl Cloth	6-10	0.500 (12.7)	1.250 (31.75)	8	3	4	250
WML-911-499	Nylon Cloth, Permanent Adhesive	6-10	1.000 (25.4)	1.250 (31.75)	8	7	10	250
WML-911-502	General-Purpose Vinyl Cloth	6-10	1.000 (25.4)	1.250 (31.75)	8	7	10	250

## Self-Laminating Wire Marker Labels

- Vinyl labels feature clear "trailer" that wraps to protect printed text
- Resistant to oil, water, and solvents



Catalog #	Approx. Wire Gauge	Max. Wire Diameter Inch (mm)	Label Width Inch (mm)	Label Height Inch (mm)	Print-Area Height	Lines of Print	Max. Characters Across Large	Max. Characters Across Small
WML-205-292-1	10-12	0.210 (5.3)	0.500 (12.7)	1.000 (25.4)	0.375 (9.53)	2	3	4
WML-205-292-2S*	10-14	0.185 (4.7)	0.500 (12.7)	0.750 (19.05)	0.400 (10.16)	2	3	4
WML-205-292-75	10-16	0.160 (4.1)	0.500 (12.7)	0.750 (19.05)	0.375 (9.53)	2	3	4
WML-211-292-1	10-12	0.210 (5.3)	1.000 (25.4)	1.000 (25.4)	0.375 (9.53)	2	7	10
WML-211-292-75	10-16	0.160 (4.1)	1.000 (25.4)	0.750 (19.05)	0.375 (9.53)	2	7	10
WML-305-292	6-10	0.260 (6.6)	0.500 (12.7)	1.25(31.75)	0.500 (12.7)	3	3	4
WML-305-292-2S*	6-10	0.260 (6.6)	0.500 (12.7)	1.25(31.75)	0.520 (13.21)	3	3	4
WML-311-292	6-10	0.260 (6.6)	1.000 (25.4)	1.25(31.75)	0.500 (12.7)	3	7	10
WML-317-292	6-10	0.260 (6.6)	1.500 (38.1)	1.25(31.75)	0.500 (12.7)	3	10	15

\*Labels are scored in half, length-wise. The width is only .25"



## Cable Marking Labels

- Clear overlaminates is ideal for cable marking applications
- Resistant to oil, water and solvents
- Withstands temperatures from -40°F to 150°F
- Excellent for underground wiring

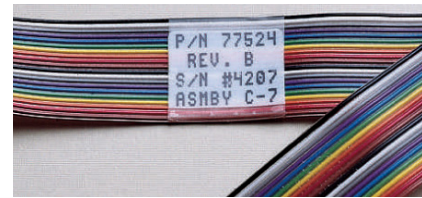

Catalog #	Material	Label Width Inch (mm)	Label Height Inch (mm)	Write-On Area Height	Max. Lines of Print	Max. Characters Across Large	Max. Characters Across Small	Labels Per Roll
WML-511-292	Self-Laminating Vinyl	1.000 (25.4)	2.500 (63.5)	0.750 (19.05)	4	7	10	100
WML-517-292	Self-Laminating Vinyl	1.500 (38.1)	2.500 (63.5)	0.750 (19.05)	4	10	15	100
WML-711-292	Self-Laminating Vinyl	1.000 (25.4)	4.000 (101.6)	1.000 (25.4)	6	7	10	100
WML-717-292	Self-Laminating Vinyl	1.500 (38.1)	4.000 (101.6)	1.000 (25.4)	6	10	15	100

## BradySleeve™ Wire Marking Sleeves

- Exclusive topcoat "soaks up" ink & retains it permanently, without additional curing
- Durable BradySleeve markers stand up to tough conditions



Catalog #	Approx. Wire Gauge	Min. Wire Dia. Inch (mm)	Max. Wire Dia. Inch (mm)	Sleeve Width Inch (mm)	Sleeve Height Inch (mm)	Max. Lines of Print	Max. Characters Across Large	Max. Characters Across Small	Sleeves Per Roll
WMS-111-321	12-18	0.075 (1.90)	0.130 (3.30)	1.000 (25.40)	3.5 (8.90)	1	7	10	500

## Multiple-Across Wire Marking Strips (Approx. wire gauge - 10-14)

Catalog #	Label Material	Label Width Inch (mm)	Label Height Inch (mm)	Max. Lines of Print	Max. Characters Across Large	Max. Characters Across Small	Number of Strips Across	Qty. Per Roll Strips/Sets
WML-505-499-2S*	Nylon Cloth	0.500 (12.7)	0.750 (19.05)	4	3	4	2	500-250
WML-505-502-2S*	White Vinyl Cloth	0.500 (12.7)	0.750 (19.05)	4	3	4	2	500/250

\*Labels are scored in half, length-wise. The width is only .25"

## Component & General Identification Labels

- Suitable for marking components in control panels, electronic components and circuit boards, faceplates and electrical receptacles
- Available in white vinyl cloth with a printable topcoat
- Withstands temperatures from -40°F to 180°F
- Resistant to oil, water and humidity
- Leaves no adhesive residue when removed
- Ideal for permanent or temporary applications



Catalog #	Label Material	Label Width Inch (mm)	Label Height Inch (mm)	Max. Lines of Print	Max. Characters Across Large	Max. Characters Across Small	Labels Per Roll
CL-105-619	Polyester	0.500 (12.7)	0.275 (7.0)	1	3	4	500
CL-111-502	Vinyl Cloth	1.000 (25.4)	0.275 (7.0)	1	7	10	500
CL-111-619	Polyester	1.000 (25.4)	0.275 (7.0)	1	7	10	500
CL-111-969	Metallized Polyester	1.000 (25.4)	0.275 (7.0)	1	7	10	500
CL-117-619	Polyester	1.000 (25.4)	0.275 (7.0)	1	10	15	500
CL-311-502	Vinyl Cloth	1.000 (25.4)	0.500 (12.7)	3	7	10	500
CL-311-619	Polyester	1.000 (25.4)	0.500 (12.7)	3	7	10	500
CL-311-969	Metallized Polyester	1.000 (25.4)	0.500 (12.7)	3	7	10	500
CL-317-619	Polyester	1.500 (38.1)	0.500 (12.7)	3	10	15	500
CL-517-619	Polyester	1.500 (38.1)	0.750 (19.05)	4	10	15	250
CL-917-619	Polyester	1.500 (38.1)	1.250 (31.75)	8	10	15	250



# Benchtop Printer Comparison

BradyID.com/s34

## Benchtop Printer Comparison Guide

Use the following comparison guide to quickly see which benchtop printer best fits your application needs. Then turn to the following pages to find out more about the printer, compatible materials and ribbons.



**MiniMark™ Label Printer**  
See Page 348



**BBP®31 Sign & Label Printer**  
See Page 352



**BBP®33 Label Printer**  
See Page 354

### Printer Specifications

<b>Description</b>	Small, compact, economical entry level printer with high speed print and 300 dpi resolution. Sharp printing on durable outdoor material.	Ultimate facility, safety and lean printer for walk-up-and-print ease of use and ease of label changeovers. Best choice for multi-user, "Lean event" labeling situations, and centrally located print areas because of its "approachable" interface and is extremely easy to use.	The first PC-connect only Facility & Safety printer with no calibration set-up, no label waste and 20-second supply changeovers. Revolutionary ease of use makes it ideal for training multiple users and saving wasted time and wasted label cost.
<b>Applications &amp; Comments</b>	Facility & safety ID, signs, pipe markers, lean/5S and equipment labels.	Facility & safety ID, signs, pipe markers, lean/5S, arc flash labels, GHS & chemical labels, equipment labels, panel & pushbutton labels, reflective & glow-in-the-dark labels, tagging, magnetic and cold-temp labeling.	Facility & safety ID, electrical, laboratory and electronics ID, signs, pipe markers, lean/5S, arc flash labels, GHS & chemical labels, equipment labels, panel & pushbutton labels, reflective & glow-in-the-dark labels, tagging, magnetic and cold-temp labeling, wire labels & sleeves, metallized, polyimide & static dissipative labeling.
<b>Label Material Types</b>	Extremely aggressive 8-10 year outdoor vinyl with high tack & chemical resistance, plus 3 other materials	Extremely aggressive 8-10 year outdoor vinyl with high tack and chemical resistance, plus, wash down material, reflective, 10-hour glow-in-the-dark, magnetic, engraved plate substitute and 8 other materials	Extremely aggressive 8-10 year outdoor vinyl with high tack and chemical resistance, plus, wash down material, reflective, 10-hour glow-in-the-dark, engraved plate substitute, 32 other materials
<b>Types of Labels Available</b>	Continuous material, some die cut labels	Continuous material, pre-printed die cut, some general die cut labels	Continuous material, pre-printed die cut, general die cut, wire labels & sleeves
<b>Print Technology</b>	Thermal Transfer	Thermal Transfer	Thermal Transfer
<b>Print Resolution</b>	203 dpi	300 dpi	300 dpi
<b>Max Print Width</b>	4.000"	4.000"	4.000"
<b>Media Widths</b>	0.500" to 4.000"	0.500" to 4.250"	0.500" to 4.250"
<b>Minimum Label Dimension</b>	0.500"	0.500"	0.250"
<b>Color Printing Capabilities</b>	Single print color on a label (some pre-printed multicolor supplies also available)	Single print color on a label (some pre-printed multicolor supplies also available)	Single print color on a label (some pre-printed multicolor supplies also available)
<b>Auto Cut-off</b>	Yes	Yes	Yes
<b>X-Y Plotter Cutting (cutting out shapes &amp; text)</b>	No	No	No
<b>PC Connect or Stand Alone Operation</b>	PC Connect only	PC Connect and Stand Alone	PC Connect only
<b>Ribbon &amp; label roll installation</b>	<b>Labels:</b> Supplied in cartridge, drops into place, 20 sec changeover <b>Ribbon:</b> Loose roll, "thread-thru" required	<b>Labels:</b> Supplied in cartridge, drops into place, 15 sec changeover <b>Ribbon:</b> Supplied in cartridge, snaps into place, 5 sec changeover	<b>Labels:</b> Supplied in cartridge, drops into place, 15 sec changeover <b>Ribbon:</b> Supplied in cartridge, snaps into place, 5 sec changeover
<b>Calibration Required?</b>	Yes	No (no waste)	No (no waste)
<b>Label creation &amp; set-up</b>	Set up steps required from drop-down list in PC Software	Automatic (printer or PC software reads data on chip and automatically sets up label size, color, fonts, etc.)	Automatic (PC software reads data on chip and automatically sets up label size, color, fonts, etc.)
<b>Connectivity Options</b>	Standard: Serial, Parallel, USB, Ethernet	Standard: USB, Ethernet Optional: WiFi, WiFi Direct	Standard: USB, Ethernet Optional: WiFi, WiFi Direct
<b>Compatible Software</b>	MarkWare™ Software, Windows® based driver for 3rd party software use*	Brady Workstation Apps, MarkWare™ Software, Windows® based driver for 3rd party software use*	Brady Workstation Apps, MarkWare™ Software, Labelmark™ Software, Codesoft™ Software, Windows® based driver for 3rd party software use*
<b>Warranty</b>	5 years	5 years	5 years

# Benchtop Printer Comparison

BradyID.com/s34



**GlobalMark®2 Label Maker**  
See Page 380



**BBP®85 Sign & Label Maker**  
See Page 390

## Printer Specifications

<b>Description</b>	Rugged Safety & Facility ID printer with advanced capabilities of printing multiple print colors onto a label and cutting out basic shapes & text. Ideal for Lean, 5S, gauge labels and Plant Reliability labeling programs as well as pipe marking and general facility ID	Large 10" format multi-color facility ID printer with ultimate walk-up-and-print ease for use and no calibration set-up, no label waste and 20 second supply changeovers. Revolutionary ease of use makes it ideal for training multiple users and saving wasted time and wasted label cost.
<b>Applications &amp; Comments</b>	Facility & safety ID, signs, pipe markers, lean/5S, arc flash labels, GHS & chemical labels, equipment labels, panel labels, reflective & glow-in-the-dark labels, tagging, magnetic and cold-temp labeling.	Large-sized labels up to 10" for signs, warnings, lean/5S, arc flash, GHS chemical labels, equipment & panel labels, roll form pipe markets, reflective and glow-in-the-dark labels
<b>Label Material Types</b>	Extremely aggressive 8-10 year outdoor vinyl with high tack and chemical resistance, plus, wash down material, reflective, 10-hour glow-in-the-dark and 9 other materials	Extremely aggressive 8-10 year outdoor vinyl with high tack and chemical resistance, plus reflective, 10-hour glow-in-the-dark and polyester.
<b>Types of Labels Available</b>	Continuous material, pre-printed die cut labels	Continuous material and pre-printed die cut labels
<b>Print Technology</b>	Thermal Transfer	Thermal Transfer
<b>Print Resolution</b>	300 dpi	300 dpi
<b>Max Print Width</b>	4.000"	10.000"
<b>Media Widths</b>	0.500" to 4.250"	4.000" to 10.000"
<b>Minimum Label Dimension</b>	0.500"	4.000"
<b>Color Printing Capabilities</b>	Multiple print colors on a label (some pre-printed multicolor supplies also available)	Multiple print colors on a label (some pre-printed multicolor supplies also available)
<b>Auto Cut-off</b>	Yes	Yes
<b>X-Y Plotter Cutting (cutting out shapes &amp; text)</b>	Yes (Color & Cut model)	No
<b>PC Connect or Stand Alone Operation</b>	PC Connect and Stand Alone	PC Connect and Stand Alone
<b>Ribbon &amp; label roll installation</b>	<b>Labels:</b> Supplied in cartridge, drops into place, 15 sec changeover <b>Ribbon:</b> Supplied in cartridge, snaps into place, 5 sec changeover	<b>Labels:</b> Supplied in cartridge, 15 sec changeover <b>Ribbon:</b> Supplied on geared snap-in rolls, 5 sec changeover
<b>Calibration Required?</b>	No (no waste)	No (no waste)
<b>Label creation &amp; set-up</b>	Automatic (printer or PC reads data on chip and automatically sets up label size, color, fonts, etc.)	Automatic (printer or PC reads data on chip and automatically sets up label size, color, fonts, etc.)
<b>Connectivity Options</b>	Standard: USB	Standard: USB, Ethernet Optional: WiFi, WiFi Direct
<b>Compatible Software</b>	Brady Workstation Apps, MarkWare™ Software, Windows® based driver for 3rd party software use*	Brady Workstation Apps, MarkWare™ Software, Windows® based driver for 3rd party software use*
<b>Warranty</b>	5 years	5 years



# MiniMark™ Industrial Label Printer

BradyID.com/minimark



BRADY 360°  
**5 YEAR**  
WARRANTY

**View Online!**  
Visit [BradyID.com/minimark](http://BradyID.com/minimark) for more information on the MiniMark™ Industrial Label Printer.

**Your Complete Printing Solution:**  
MiniMark Label Rolls ..... Page 350  
MiniMark Print Ribbons ..... Page 351

## MINIMARK™ INDUSTRIAL LABEL PRINTER

The Brady MiniMark™ Industrial Label Printer offers an affordable sign and label making solution that is compact, fast, and incredibly versatile. You won't believe how powerful and easy Brady's MarkWare Express Software is until you try it!

- APPLICATIONS – Signs, Pipe Markers, Equipment ID, Racks & Shelving, and more!
- VERSATILE – Uses continuous tapes for multiple applications
- POWERFUL – Ships with Brady's MarkWare Express Software
- FAST – Prints up to three inches per second
- EASY-LOAD-SUPPLIES – Arrive pre-loaded on spindles with flanges to prevent telescoping tape. Drop-in ease of loading.
- COMPACT – Doesn't take up a lot of space in work areas
- SOFTWARE COMPATABILITY – Ships with MarkWare™ Express Software but can also be used with MarkWare Standard Software and MarkWare Lean Software
- CUTTER – Built-in cutter minimizes waste

## MarkWare™ Express Software

(Express version of software ships with every MiniMark Printer.)

The ultimate sign and pipe marker database.

MarkWare™ Express Software contains thousands of pre-made pipe markers, OSHA signs, and labels ready to print as-is or customize with a click of your mouse! Fast. Accurate. Amazing!

- Signs, labels, tags, pipe markers and more - all pre-made and ready to print or customize
- Thousands of stock legends
- 1-Click translation of your selected sign or pipemarker into French or Spanish
- High-speed search gives you instant access
- OSHA and ANSI sign formats, ANSI-ASME Pipe Markers



## The Next Small Thing in Fast Labeling



Labels



Pipe & Valve ID



General ID



Panel & Enclosure ID



Bin & Storage ID



Lean / 5S Labeling

# MiniMark™ Industrial Label Printer

BradyID.com/minimark

## MiniMark™ Industrial Label Printer Specifications

<b>Description</b>	Rugged Safety & Facility ID printer with advanced capabilities of printing multiple print colors onto a label and cutting out basic shapes & text. Ideal for Lean, 5S, gauge labels and Plant Reliability labeling programs as well as pipe marking and general facility ID
<b>Applications &amp; Comments</b>	Facility & safety ID, signs, pipe markers, lean/5S, arc flash labels, GHS & chemical labels, equipment labels, panel labels, reflective & glow-in-the-dark labels, tagging, magnetic and cold-temp labeling.
<b>Label Material Types</b>	Extremely aggressive 8-10 year outdoor vinyl with high tack and chemical resistance, plus, wash down material, reflective, 10-hour glow-in-the-dark and 9 other materials
<b>Types of labels available</b>	Continuous material, pre-printed die cut labels
<b>Print Technology</b>	Thermal Transfer
<b>Print Resolution</b>	300 dpi
<b>Max Print Width</b>	4.000"
<b>Media Widths</b>	0.500" to 4.250"
<b>Minimum Label Dimension</b>	0.500"
<b>Color Printing Capabilities</b>	Multiple print colors on a label (some pre-printed multicolor supplies also available)
<b>Auto Cut-off</b>	Yes
<b>X-Y Plotter Cutting (cutting out shapes &amp; text)</b>	Yes (Color & Cut model)
<b>PC Connect or Stand Alone Operation</b>	PC Connect and Stand Alone
<b>Ribbon &amp; label roll installation</b>	<b>Labels:</b> Supplied in cartridge, drops into place, 15 sec changeover <b>Ribbon:</b> Supplied in cartridge, snaps into place, 5 sec changeover
<b>Calibration Required?</b>	No (no waste)
<b>Label creation &amp; set-up</b>	Automatic (printer or PC reads data on chip and automatically sets up label size, color, fonts, etc.)
<b>Connectivity Options</b>	Standard: USB
<b>Compatible Software</b>	MarkWare™ Software, Windows® based driver for 3rd party software use*
<b>Warranty</b>	5 years



## MiniMark™ Printer and Accessories

Catalog #	Description
52041	MiniMark™ Industrial Label Printer*
134109	MiniMark Printer* + MarkWare Standard Software
134110	MiniMark Printer* + MarkWare Lean Software
105089	<b>General Industrial Supplies Starter Package</b> (Printer Sold Separately) Contents: MarkWare™ software; 2 rolls each of 4" white and yellow vinyl; 2 rolls each of 2.25" white and yellow vinyl; 2 rolls each of 1.125" white and yellow vinyl; and 8 rolls (4 pkgs.) of black ribbon. All vinyl is B-595 vinyl.
105088	<b>Pipe Marker Supplies Starter Package</b> (Printer Sold Separately) Contents: MarkWare™ software; 3 rolls of 4" yellow vinyl; 1 roll each of 4" red, green, and blue vinyl; 3 rolls of 2.25" yellow vinyl; 1 roll each of 2.25" red, green, and blue vinyl; 1 roll each of 1.125" yellow, red, green, and blue vinyl; and 6 rolls each (3 pkgs. each) of black and white ribbon. All vinyl is B-595 vinyl.

\*Printer ships with Markware Express Software, USB cable, and cleaning kit.

## MiniMark™ Software Solution:



### MarkWare™ Facility Identification Software

CD-based software option for creating custom safety signs & labels including pipe markers, ANSI signs, lockout tags, GHS labels, RTK chemical labels, lean 5S visuals and custom labels with barcodes and graphics. Built-in graphics and 2,000 chemical database for RTK. Pre-formatted GHS label templates.

View page 405 for more information.

## Brady360® 5 Year Warranty We have you Covered.

We always stand behind our products to make sure they deliver you an unrivaled customer experience. We've strengthened our commitment to you with a **5-year printer warranty standard and free of charge** on our benchtop printer models.\* With a team of 30 certified tech support and repair technicians and our 5-year warranty backing you up, you can rest assured you'll have the support you need—every step of the way.



### Free 5-year warranty standard on Benchtop models\* covers:

- Repair parts & labor
- One print head replacement
- Free loaner printer during repairs
- Free return shipping after repair
- Free Brady 360® stress-free printer setup session
- Free lifetime technical support via phone and email
- Free lifetime firmware upgrades
- One free Brady 360® preventative maintenance service

### Access to additional fee-based support:

- On-site repair service
- On-site custom set-up and training
- Additional print head coverage (after the first free replacement)
- Advanced custom integration, programming support and template creation

\*Excludes repairs due to negligence. Excludes Wraptor™ model and handheld models. See BradyID.com/brady360 for full coverage details & restrictions.



# MiniMark™ Label Materials

BradyID.com/minimark

## Indoor/Outdoor Grade Vinyl (B-595)

- Conforms well to irregular, curved, rough and highly textured surfaces while adhering to “difficult” low-surface energy items including PVC piping, blow-molded equipment cases, ABS plastics, and recycled plastics
- 8-10 year average outdoor durability in temperatures from -40°F to 180°F (-40°C to 82°C). Labels can be applied in temperatures from 0°F to 180°F
- Patent Number D481.414



Figure 33b

	4.000" x 100' (101.6mm x 30.48m)	3.000" x 100' (76.2mm x 30.48m)	2.250" x 100' (57.2mm x 30.48m)	1.125" x 100' (28.6mm x 30.48m)	0.500" x 100' (12.7mm x 30.48m)	Rec. Ribbon
White	113182	113183	113184	113185	113186	103025
Yellow	113191	113192	113193	113194	113195	103025
Red	113196	-	113197	113198	113199	103026
Blue	113208	-	113209	113210	113211	103026
Green	113204	-	113205	113206	113207	103026
Black	113212	-	113213	113214	113215	103026
Brown	115759	-	115760	115761	115762	103026
Gold	115755	-	115756	115757	115758	103025
Grey	113218	-	113219	115753	115754	103025
Purple	113216	-	113217	115751	115752	103026
Orange	113200	-	113201	113202	113203	103025
Clear	113187	-	113188	113189	113190	103025

## General Purpose Indoor/Outdoor Vinyl (B-7569)

- Excellent for facility, safety, chemical and lean 5S labeling
- Five year average outdoor durability in temperatures from -40°F to 180°F (-40°C to 82°C). Labels can be applied in temperatures from 0°F to 180°F
- Patent Number D481.414



Figure 33b

Diagram	Catalog #	Material	Color	Label Width A Inch (mm)	Roll Length B Foot (m)	Labels Per Roll	Rec. Ribbon
Fig. 33b	120847	B-7569	White	1.125" (28.6 mm)	110 ft (33.5 m)	1 Roll (cont.)	52042
Fig. 33b	120854	B-7569	White	2.25" (57.2 mm)	110 ft (33.5 m)	1 Roll (cont.)	52042
Fig. 33b	120861	B-7569	White	4.00" (101.6 mm)	110 ft (33.5 m)	1 Roll (cont.)	52042
Fig. 33b	120848	B-7569	Yellow	1.125" (28.6 mm)	110 ft (33.5 m)	1 Roll (cont.)	52042
Fig. 33b	120855	B-7569	Yellow	2.25" (57.2 mm)	110 ft (33.5 m)	1 Roll (cont.)	52042
Fig. 33b	120862	B-7569	Yellow	4.00" (101.6 mm)	110 ft (33.5 m)	1 Roll (cont.)	52042
Fig. 33b	120849	B-7569	Red	1.125" (28.6 mm)	110 ft (33.5 m)	1 Roll (cont.)	52042
Fig. 33b	120856	B-7569	Red	2.25" (57.2 mm)	110 ft (33.5 m)	1 Roll (cont.)	52042
Fig. 33b	120863	B-7569	Red	4.00" (101.6 mm)	110 ft (33.5 m)	1 Roll (cont.)	52042
Fig. 33b	120851	B-7569	Blue	1.125" (28.6 mm)	110 ft (33.5 m)	1 Roll (cont.)	52044
Fig. 33b	120858	B-7569	Blue	2.25" (57.2 mm)	110 ft (33.5 m)	1 Roll (cont.)	52044
Fig. 33b	120865	B-7569	Blue	4.00" (101.6 mm)	110 ft (33.5 m)	1 Roll (cont.)	52044
Fig. 33b	120850	B-7569	Green	1.125" (28.6 mm)	110 ft (33.5 m)	1 Roll (cont.)	52044
Fig. 33b	120857	B-7569	Green	2.25" (57.2 mm)	110 ft (33.5 m)	1 Roll (cont.)	52044
Fig. 33b	120864	B-7569	Green	4.00" (101.6 mm)	110 ft (33.5 m)	1 Roll (cont.)	52044
Fig. 33b	120852	B-7569	Orange	1.125" (28.6 mm)	110 ft (33.5 m)	1 Roll (cont.)	52042
Fig. 33b	120859	B-7569	Orange	2.25" (57.2 mm)	110 ft (33.5 m)	1 Roll (cont.)	52042
Fig. 33b	120866	B-7569	Orange	4.00" (101.6 mm)	110 ft (33.5 m)	1 Roll (cont.)	52042
Fig. 33b	120853	B-7569	Black	1.125" (28.6 mm)	110 ft (33.5 m)	1 Roll (cont.)	52044
Fig. 33b	120860	B-7569	Black	2.25" (57.2 mm)	110 ft (33.5 m)	1 Roll (cont.)	52044
Fig. 33b	120867	B-7569	Black	4.00" (101.6 mm)	110 ft (33.5 m)	1 Roll (cont.)	52044

## Tamper-Evident Metallized Polyester (B-438)

- Permanent adhesive
- Tape destructs into tiny fragments when tampered with, making removal very tedious and difficult

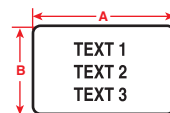

Figure 29



Diagram	Catalog #	Material	Color	Label Width A Inch (mm)	Label Height B Inch (mm)	Labels Per Row	Labels Per Roll	Rec. Ribbon
Fig. 29	52148	B-438	Silver	2.000 (50.8)	1.000 (25.4)	1	1,240	105031
Fig. 29	52149	B-438	Silver	3.000 (76.2)	1.000 (25.4)	1	1,225	105031
Fig. 29	52150	B-438	Silver	3.000 (76.2)	2.000 (50.8)	1	650	105031
Fig. 29	52152	B-438	Silver	3.000 (76.2)	110 ft. (33.5 m)	-	1 Roll (cont.)	105031

## Pre-Print Header Stripe Supply For Arc Flash Labels And Signs (B-595)

- Pre-printed continuous stripe on top portion of white vinyl, then supply is cut-to-length according to length of text entered
- Ideal for printing Arc Flash labels and other signs using Markware™ Software
- Use ribbons for B-595 Heavy Duty Vinyl

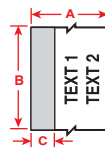

Figure 71



Diagram	Catalog #	Material	Stripe Color	Label Height A Inch (mm)	Roll Length B Feet (m)	Stripe Width C Inch (mm)	Labels Per Roll
Fig. 71	113221	B-595	Red	4.000 (101.6)	100 ft. (30.48m)	1.000 (25.4)	1 Roll (cont.)
Fig. 71	113225	B-595	Red	3.000 (76.2)	100 ft. (30.48m)	0.750 (19.05)	1 Roll (cont.)
Fig. 71	113230	B-595	Red	2.250 (57.15)	100 ft. (30.48m)	0.500 (12.7)	1 Roll (cont.)
Fig. 71	113222	B-595	Orange	4.000 (101.6)	100 ft. (30.48m)	1.000 (25.4)	1 Roll (cont.)
Fig. 71	113227	B-595	Orange	3.000 (76.2)	100 ft. (30.48m)	0.750 (19.05)	1 Roll (cont.)
Fig. 71	113228	B-595	Orange	2.250 (57.15)	100 ft. (30.48m)	0.500 (12.7)	1 Roll (cont.)
Fig. 71	113220	B-595	Yellow	4.000 (101.6)	100 ft. (30.48m)	1.000 (25.4)	1 Roll (cont.)
Fig. 71	113226	B-595	Yellow	3.000 (76.2)	100 ft. (30.48m)	0.750 (19.05)	1 Roll (cont.)
Fig. 71	113229	B-595	Yellow	2.250 (57.15)	100 ft. (30.48m)	0.500 (12.7)	1 Roll (cont.)

## Self Laminating Vinyl Wire And Cable Markers (B-427)

Ideal for marking data cabling, this cable marker's protected printing offers superior abrasion resistance and resistance to dirt, oils, solvents and water. Marker features a clear, non-printed area which wraps around and overlaminates the printed text. Printer automatically "multiple repeats" your text in the white print area. B-427 Vinyl Self Laminating material.

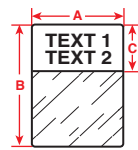

Figure 42



- Resistant to abrasion, water, oil and solvents
- Temp range -94°F to 158°F (-70°C to 70°C)
- UL recognized

Diagram	Catalog #	Material	Color	Label Width A Inch (mm)	Label Height B Inch (mm)	Write-On Area C Inch (mm)	Labels Per Row	Labels Per Roll	Rec. Ribbon
Fig. 42	52153	B-427	White	0.500 (12.7)	1.25 (31.8)	0.500 (12.7)	4	2,800	105031
Fig. 42	52155	B-427	White	1.000 (25.4)	1.000 (25.4)	0.375 (9.5)	4	3,275	105031
Fig. 42	52156	B-427	White	1.000 (25.4)	1.250 (31.8)	0.500 (12.7)	4	2,780	105031
Fig. 42	52157	B-427	White	1.000 (25.4)	2.500 (63.5)	0.750 (19.1)	4	1,485	105031
Fig. 42	52158	B-427	White	1.500 (38.1)	2.500 (63.5)	0.750 (19.1)	4	1,000	105031

## MiniMark™ Print Ribbons



### MiniMark™ Print Ribbons For B-595 Vinyl

- Hassle-free! Pre-loaded onto spindles with "keyed" end caps. Ribbons install faster and always facing the correct direction
- Tough, smear proof ribbons that produce long-lasting printed text
- Withstands years in industrial and outdoor areas

### Ribbons For B-595 Vinyl

Catalog #	Roll Size	Color	Rolls Per Pkg.
103026	4" x 290'	White	2
103025	4" x 290'	Black	2
103027	4" x 290'	Red	2
103029	4" x 290'	Green	2
103030	4" x 290'	Yellow	2
103028	4" x 290'	Blue	2
103031	4" x 290'	Orange	2



### MiniMark™ Print Ribbons for B-7569 Vinyl

- Tough, smear proof ribbons that produce long-lasting printed text
- Withstands years in industrial and outdoor areas

### Ribbons For B-7569 Vinyl

Catalog #	Roll Size	Color	Rolls Per Pkg.
52044	4.4" x 290'	White	2
52042	4.4" x 290'	Black	2
52045	4.4" x 290'	Red	2
52059	4.4" x 290'	Green	2
52047	4.4" x 290'	Blue	2



# BBP<sup>®</sup>31 Sign & Label Printer

BradyID.com/bbp31

BRADY 360  
**5 YEAR**  
WARRANTY



## BBP<sup>®</sup>31 SIGN & LABEL PRINTER

### Walk-up-and-print for ultimate ease of use

- Still the easiest! Just walk up and print. Literally. The best choice for facility and safety and lean/5S “Kaizen event” labeling
- Safety, facility and lean/5S applications – 275 parts, 12 materials
- Stand-alone operation ideal for mobile use and “lean events”
- Intuitive, simple to learn, very approachable – ideal for multi-user situations, events, and centrally located print stations - simple to train multiple users
- 20-second supply changeover with no waste, calibration or trial & error setup!
- Stand-alone use or PC-Connect use all in one printer
- Compatible with the new Brady Workstation Apps, and Brady’s powerful MarkWare™ PC software, plus has Windows® based driver for 3rd party software use (ex: print from MSWord)

#### Online Videos!

Visit [BradyID.com/bbp31](http://BradyID.com/bbp31) to watch the BBP<sup>®</sup>31 Sign & Label Printer video demos.

#### Your Complete Printing Solution:

BBP31 Label Materials ..... Page 357  
BBP31 Print Ribbons ..... Page 379

### Automatic label setup with no calibration

The printer “reads” information from your cartridges and automatically sets up the label correctly in the printer or your Brady software.

- No sensor adjustment or calibration (or wasted materials!)
- No print speed or burn temp trials and errors (or wasted materials!)
- No scrolling through lists searching for label part
- No need to set up label dimensions in software

### 20-second material changeovers

- Ribbon and label changeovers, in as fast as 20 seconds!
- Foolproof “drop-in” ribbon and label cartridges (anyone can do it!)
- No threading the ribbon around spools and printheads
- Ink side of ribbon always faces the right way
- Easy-to-handle cartridges that won’t roll away or get damaged



Just walk up and print. So simple, your whole team can use it!



Pipe Marking



GHS Labeling



Safety Tags



Lean / 5S Labeling



Safety Signs



Equipment & Panel Labeling



BBP®31 Printer Specifications	
<b>Description</b>	Ultimate facility, safety and lean 5S printer for walk-up-and-print ease of use and ease of label changeovers. Best choice for multi-user, "Lean event" labeling situations, and centrally located print areas.
<b>Applications &amp; Comments</b>	Facility & safety ID, signs, pipe markers, lean/5S, arc flash labels, GHS labels, equipment labels, panel & pushbutton labels, reflective & glow-in-the-dark labels, tagging, magnetic and cold-temp labeling.
<b>Label Material Types</b>	Extremely aggressive 8-10 year outdoor vinyl with high tack and chemical resistance, plus, wash down material, reflective, 10-hour glow-in-the-dark, magnetic, engraved plate substitute and 8 other materials
<b>Types of labels available</b>	Continuous material, pre-printed die cut, some general die cut labels
<b>Print Technology</b>	Thermal Transfer
<b>Print Resolution</b>	300 dpi
<b>Max Print Width</b>	4.000"
<b>Media Widths</b>	0.500" to 4.250"
<b>Minimum Label Dimension</b>	0.500"
<b>Color Printing Capabilities</b>	Single print color on a label (some pre-printed multicolor supplies also available)
<b>Auto Cut-off</b>	Yes
<b>X-Y Plotter Cutting (cutting out shapes &amp; text)</b>	No
<b>PC Connect or Stand Alone Operation</b>	PC Connect and Stand Alone
<b>Ribbon &amp; label roll installation</b>	<b>Labels:</b> Supplied in cartridge, drops into place, 15 sec changeover <b>Ribbon:</b> Supplied in cartridge, snaps into place, 5 sec changeover
<b>Calibration Required?</b>	No (no waste)
<b>Label creation &amp; set-up</b>	Automatic (printer or PC software reads data on chip and automatically sets up label size, color, fonts, etc.)
<b>Connectivity Options</b>	Standard: USB, Ethernet Optional: WiFi, WiFi Direct
<b>Compatible Software</b>	Brady Workstation Apps, MarkWare™ Software, Windows® based driver for 3rd party software use*
<b>Warranty</b>	5 years

U.S. Patent Nos. 8,542,155; 8,648,891; 5,823,689; 6,570,602. Additional Patents Pending.



## BBP®31 Printer and Accessories

Catalog #	Description
BBP31	BBP31 Sign & Label Printer*
BBP31-MWS	BBP31 Printer* and MarkWare™ Std Software
BBP31-MWL	BBP31 Printer* and MarkWare™ Lean Software
120994	Rolling case w/ handle and supplies pockets for benchtop printers
B31-WIPER	5 pack of extra media wipers
B31-CCT	3 pack of extra cutter cleaning tools
<b>Printer and Tape Starter Packs - View kit contents on page 378.</b>	
BBP31-ARCLASH-KIT	BBP31 Printer* w/ Arc Flash Supply Kit
BBP31-SFTY-KIT	BBP31 Printer* w/ Safety & Compliance Supply Kit
BBP31-LEANWV-KIT	BBP31 Printer* w/ 5S Visual Workplace Supply Kit
BBP31-PIPE-KIT	BBP31 Printer* w/ Pipe ID Supply Kit
BBP31-GENIND-KIT	BBP31 Printer* w/ General Industrial 5S Supply Kit

\* BBP31 Sign & Label Printer ships with printer, power cord, USB cable, drivers CD, stylus, cleaning kit, cutter cleaning tool, quick start guide and documentation holder.

## BBP®31 Software Solutions:



### Brady Workstation Apps

Brady has revolutionized its label creation software by now offering apps specific to your projects.

Once the free Brady Workstation is installed on your PC, you can then download a variety of free or paid labeling apps including Custom Label Designer, Express Signs, Pipe Markers, Lockout Writer and GHS. View page 404 or download at [workstation.bradyid.com](http://workstation.bradyid.com)



### MarkWare™ Facility Identification Software

CD-based software option for creating custom safety signs & labels including pipe markers, ANSI signs, lockout tags, GHS labels, RTK chemical labels, lean 5S visuals and custom labels with barcodes and graphics. Built-in graphics and 2,000 chemical database for RTK. Pre-formatted GHS label templates. View page 405 for more information.

## Brady360® 5 Year Warranty We have you Covered.



We always stand behind our products to make sure they deliver you an unrivaled customer experience.

We've strengthened our commitment to you with a **5-year printer warranty standard and free of charge** on our benchtop printer models.\* With a team of 30 certified tech support and repair technicians and our 5-year warranty backing you up, you can rest assured you'll have the support you need—every step of the way.

### Free 5-year warranty standard on Benchtop models\* covers:

- Repair parts & labor
- One print head replacement
- Free loaner printer during repairs
- Free return shipping after repair
- Free Brady 360® stress-free printer setup session
- Free lifetime technical support via phone and email
- Free lifetime firmware upgrades
- One free Brady 360® preventative maintenance service

### Access to additional fee-based support:

- On-site repair service
- On-site custom set-up and training
- Additional print head coverage (after the first free replacement)
- Advanced custom integration, programming support and template creation

\*Excludes repairs due to negligence. Excludes Wraptor™ model and handheld models. See [BradyID.com/brady360](http://BradyID.com/brady360) for full coverage details & restrictions.



# BBP<sup>®</sup>33 Label Printer

BradyID.com/bbp33



## BBP<sup>®</sup>33 LABEL PRINTER

**Unbelievably easy. No wasted labels. The way label making should be.**

Introducing the BBP<sup>®</sup>33 Label Printer - and a whole new way to make labels. No more tedious, time-consuming setups or calibrations. No more difficult-to-load materials. No more wasted labels. No more hassles. This PC-connect only printer is so simple to use, most of our customers don't even believe us the first time we show them. But believe it, because it really is that easy.

It's an industrial label printer that's simple, powerful and brilliantly fast. Exactly the way label making should be.

### No calibration. No wasted labels.

- The printer "reads" your cartridges and then automatically sets up the label correctly in your Brady software.
- No wasted labels (prints on the first label!)
- No sensor adjustment
- No need to specify if gapped or notched supply
- No print speed or burn temp trials and errors
- No need to set up label dimensions in software
- No importing label file patches into software
- No scrolling through lists to select your label part



#### View Online!

Visit [BradyID.com/bbp33](http://BradyID.com/bbp33) for more information on the BBP33 Label Printer.

#### Your Complete Printing Solution:

BBP33 Label Materials.....Page 357  
BBP33 Print Ribbons.....Page 379



### 20 second material changeovers

- Ribbon and label changeovers, in as fast as 20 seconds!
- Foolproof "drop-in" ribbon and label cartridges
- No threading the ribbon around spools and printheads
- Ink side of ribbon always faces the right way
- Easy-to-handle cartridges that won't roll away or get damaged

### Impressive material lineup

- With over 550 parts and 40 materials, this printer meets your primary labeling needs, and so much more.
- Safety & arc flash labels AND wire & panel labels
- Pipe markers & 5S labels AND general purpose die cut labels
- Production line facility labels AND rating plates & circuit board labels

### Brady Materials Made To Impress.



Industrial Labeling



Arc Flash Labeling



Circuit Board Labeling



Product Identification Labels



Raised Panel Labeling

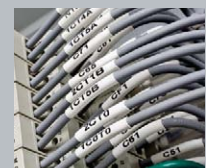

Wire & Cable Labels and more!

## BBP<sup>®</sup>33 Printer Specifications

<b>Description</b>	The first PC-connect only Facility & Safety printer with no calibration set-up, no label waste and 20-second supply changeovers. Revolutionary ease of use makes it ideal for training multiple users and saving wasted time and wasted label cost.
<b>Applications &amp; Comments</b>	Facility & safety ID, electrical, laboratory and electronics ID, signs, pipe markers, lean/5S, arc flash labels, GHS & chemical labels, equipment labels, panel & pushbutton labels, reflective & glow-in-the-dark labels, tagging, magnetic and cold-temp labeling, wire labels & sleeves, metallized, polyimide & static dissipative labeling.
<b>Label Material Types</b>	Extremely aggressive 8-10 year outdoor vinyl with high tack and chemical resistance, plus, wash down material, reflective, 10-hour glow-in-the-dark, engraved plate substitute, 32 other materials
<b>Types of labels available</b>	Continuous material, pre-printed die cut, general die cut, wire labels & sleeves
<b>Print Technology</b>	Thermal Transfer
<b>Print Resolution</b>	300 dpi
<b>Max Print Width</b>	4.000"
<b>Media Widths</b>	0.500" to 4.250"
<b>Minimum Label Dimension</b>	0.240"
<b>Color Printing Capabilities</b>	Single print color on a label (some pre-printed multicolor supplies also available)
<b>Auto Cut-off</b>	Yes
<b>X-Y Plotter Cutting (cutting out shapes &amp; text)</b>	No
<b>PC Connect or Stand Alone Operation</b>	PC Connect only
<b>Ribbon &amp; label roll installation</b>	<b>Labels:</b> Supplied in cartridge, drops into place, 15 sec changeover <b>Ribbon:</b> Supplied in cartridge, snaps into place, 5 sec changeover
<b>Calibration Required?</b>	No (no waste)
<b>Label creation &amp; set-up</b>	Automatic (PC software reads data on chip and automatically sets up label size, color, fonts, etc.)
<b>Connectivity Options</b>	Standard: USB, Ethernet Optional: WiFi, WiFi Direct
<b>Compatible Software</b>	Brady Workstation Apps, MarkWare <sup>™</sup> Software, Labelmark <sup>™</sup> Software, Codesoft <sup>™</sup> Software, Windows <sup>®</sup> based driver for 3rd party software use*
<b>Warranty</b>	5 years

U.S. Patent Nos. 5,823,689; 6,570,602.  
Additional Patents Pending.

## BBP<sup>®</sup>33 Label Printer and Accessories

Catalog #	Description
BBP33-C	BBP33 Label Printer* with Auto cutter
BBP33-C-LMP	BBP33 Label Printer* with Auto cutter and LabelMark <sup>™</sup> Pro Software
BBP33-C-MWS	BBP33 Label Printer* with Auto cutter and MarkWare <sup>™</sup> Software
BBP33-C-LMP-MWS	BBP33 Label Printer* with Auto cutter, LabelMark <sup>™</sup> Pro Software & MarkWare <sup>™</sup> Software
120994	Rolling case w/ handle and supplies pockets for benchtop printers
B31-WIPER	5 pack of extra media wipers
B31-CCT	1 pack of extra cutter cleaning tools

\* BBP33 Label Printer ships with printer, power cord, USB cable, drivers CD, stylus, cleaning kit, cutter cleaning tool and quick start guide.

## BBP<sup>®</sup>33 Software Solutions:



### Brady Workstation Apps

Brady has revolutionized its label creation software by now offering apps specific to your projects. Once the free Brady Workstation is installed on your PC, you can then download a variety of free or paid labeling apps including Custom Label Designer, Express Signs, Pipe Markers, Lockout Writer and GHS. *View page 404 for more information or download at [workstation.bradyid.com](http://workstation.bradyid.com)*



### MarkWare<sup>™</sup> Facility Identification Software

CD-based software option for creating custom safety signs & labels including pipe markers, ANSI signs, lockout tags, GHS labels, RTK chemical labels, lean 5S visuals and custom labels with barcodes and graphics. Built-in graphics and 2,000 chemical database for RTK. Pre-formatted GHS label templates. *View page 405 for more information.*



### LabelMark<sup>™</sup> Labeling Software

Robust software solution for label design, data importing, editing and printing. Written specifically for wire and datacomm ID, ADM labeling and general industrial applications. *View page 408 for more information.*



### CodeSoft<sup>™</sup> Label Design Software

This powerful enterprise level label creation software features more extensive capabilities for integration with 3rd party software applications. *View page 409 for more information.*

## Brady360<sup>®</sup> 5 Year Warranty We have you Covered.



We always stand behind our products to make sure they deliver you an unrivaled customer experience. We've strengthened our commitment to you with a **5-year printer warranty standard and free of charge** on our benchtop printer models.\* With a team of 30 certified tech support and repair technicians and our 5-year warranty backing you up, you can rest assured you'll have the support you need—every step of the way.

### Free 5-year warranty standard on Benchtop models\* covers:

- Repair parts & labor
- One print head replacement
- Free loaner printer during repairs
- Free return shipping after repair
- Free Brady 360<sup>®</sup> stress-free printer setup session
- Free lifetime technical support via phone and email
- Free lifetime firmware upgrades
- One free Brady 360<sup>®</sup> preventative maintenance service

### Access to additional fee-based support:

- On-site repair service
- On-site custom set-up and training
- Additional print head coverage (after the first free replacement)
- Advanced custom integration, programming support and template creation

\*Excludes repairs due to negligence. Excludes Wraptor<sup>™</sup> model and handheld models. See [BradyID.com/brady360](http://BradyID.com/brady360) for full coverage details & restrictions.



# BBP<sup>®</sup>31 and BBP<sup>®</sup>33 Materials

BradyID.com/bbp31

## Brady Materials Are Made To Impress.

Benchtop Printers



### Brady labels last the longest, period.

Brady labels stick and stay stuck, plain and simple. In fact, some last up to 10 years outdoors. You only need to make these labels once!

### Options. Lots of options.

We make labels for specific applications. That's why we have hundreds of label types and sizes to choose from. And if you don't see the label you need we'll custom-produce it to your size and shape requirements. We want you to be 100% confident that you have the right label for your exact application.

### We set the bar high.

Brady materials lead the industry in durability and performance because we design and manufacture every label ourselves in our own facilities. We put our materials through rigorous, painstaking tests and trials – and nothing leaves our doors until it passes with flying colors.

### With label printing like this, the possibilities are endless.

**!** **When you see this...**  
BBP31 and BBP33 It's letting you know which printer model each supply part can be used with.



View all BBP<sup>®</sup>33 and BBP<sup>®</sup>33 Print Ribbon parts on page 379.

## Pre-Printed GHS / CLP Chemical Labels (B-7569)

- Blank labels with pre-printed red diamonds allow printer to produce 2-color GHS / CLP labels in one print pass
- 3 sizes of labels, each with 6 diamond layouts that match templates in MarkWare™ Software
- Indoor/outdoor vinyl material withstands exposure to moisture, chemicals and handling
- MarkWare Software v3.9.1 or higher required (upgrades available for current MarkWare owners)

Service temp: -4°F to 180°F Application temp: 50°F to 180°F  
Average Outdoor Durability: 3-5 years

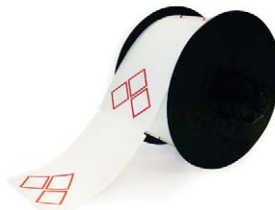

Fits Printer Model(s)	Catalog #	B#	Material	Legend	Label Height Inch (mm)	Label Width Inch (mm)	Labels Per Row	Labels Per Roll	Rec. Ribbon	
BBP31, BBP33	B30-260-7569-CLP1	B-7569	Vinyl		L1 Diamond + Text	2.170 (55.0)	3.350 (85.0)	1	340	B30-R10000
BBP31, BBP33	B30-261-7569-CLP1	B-7569	Vinyl		L1 Diamond + Text	2.950 (75.0)	4.330 (110.0)	1	270	B30-R10000
BBP31, BBP33	B30-262-7569-CLP1	B-7569	Vinyl		L1 Diamond + Text	4.130 (105.0)	6.100 (155.0)	1	200	B30-R10000
BBP31, BBP33	B30-260-7569-CLP2	B-7569	Vinyl		L2 Diamond + Text	2.170 (55.0)	3.350 (85.0)	1	340	B30-R10000
BBP31, BBP33	B30-261-7569-CLP2	B-7569	Vinyl		L2 Diamond + Text	2.950 (75.0)	4.330 (110.0)	1	270	B30-R10000
BBP31, BBP33	B30-262-7569-CLP2	B-7569	Vinyl		L2 Diamond + Text	4.130 (105.0)	6.100 (155.0)	1	200	B30-R10000
BBP31, BBP33	B30-260-7569-CLP3A	B-7569	Vinyl		L3A Diamond + Text	2.170 (55.0)	3.350 (85.0)	1	340	B30-R10000
BBP31, BBP33	B30-261-7569-CLP3A	B-7569	Vinyl		L3A Diamond + Text	2.950 (75.0)	4.330 (110.0)	1	270	B30-R10000
BBP31, BBP33	B30-262-7569-CLP3A	B-7569	Vinyl		L3A Diamond + Text	4.130 (105.0)	6.100 (155.0)	1	200	B30-R10000
BBP31, BBP33	B30-260-7569-CLP3B	B-7569	Vinyl		L3B Diamond + Text	2.170 (55.0)	3.350 (85.0)	1	340	B30-R10000
BBP31, BBP33	B30-261-7569-CLP3B	B-7569	Vinyl		L3B Diamond + Text	2.950 (75.0)	4.330 (110.0)	1	270	B30-R10000
BBP31, BBP33	B30-262-7569-CLP3B	B-7569	Vinyl		L3B Diamond + Text	4.130 (105.0)	6.100 (155.0)	1	200	B30-R10000
BBP31, BBP33	B30-260-7569-CLP4A	B-7569	Vinyl		L4A Diamond + Text	2.170 (55.0)	3.350 (85.0)	1	340	B30-R10000
BBP31, BBP33	B30-261-7569-CLP4A	B-7569	Vinyl		L4A Diamond + Text	2.950 (75.0)	4.330 (110.0)	1	270	B30-R10000
BBP31, BBP33	B30-262-7569-CLP4A	B-7569	Vinyl		L4A Diamond + Text	4.130 (105.0)	6.100 (155.0)	1	200	B30-R10000
BBP31, BBP33	B30-260-7569-CLP4B	B-7569	Vinyl		L4B Diamond + Text	2.170 (55.0)	3.350 (85.0)	1	340	B30-R10000
BBP31, BBP33	B30-261-7569-CLP4B	B-7569	Vinyl		L4B Diamond + Text	2.950 (75.0)	4.330 (110.0)	1	270	B30-R10000
BBP31, BBP33	B30-262-7569-CLP4B	B-7569	Vinyl		L4B Diamond + Text	4.130 (105.0)	6.100 (155.0)	1	200	B30-R10000



### MarkWare™ Software now includes a GHS / CLP Label Module

- 18 pre-formatted label layouts and approved GHS symbols are built-in
- User selects approved pre-worded hazard statements and GHS symbols which then automatically populates into layout – no need to type everything in
- Prompts for additional variable data which then auto-populates into layout
- Indoor/outdoor vinyl material withstands exposure to moisture, chemicals and handling
- Choose a second language and MarkWare auto-populates in the second language

Catalog #	Description
20700	MarkWare™ Software

Already own MarkWare Software?  
Go to [BradyID.com/markware](http://BradyID.com/markware) to upgrade your current MarkWare to v3.9.1 for the GHS / CLP Label Module.

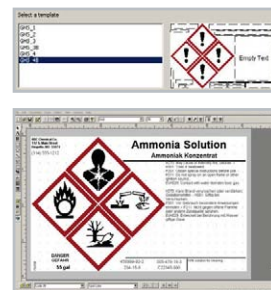

**New Brady Workstation GHS App Also Available!** See page 404 for more information.

View all BBP<sup>®</sup>33 and BBP<sup>®</sup>33 Print Ribbon parts on page 379.



# BBP<sup>®</sup>31 and BBP<sup>®</sup>33 Materials

BradyID.com/bbp31

## Indoor/Outdoor Vinyl (B-595)

- For general facility and safety identification: Our best industrial vinyl yet
- Durable, low-shrink vinyl with our most aggressive adhesive
- Conforms to irregular, curved, rough and highly textured surfaces (painted cinder blocks, uneven wood, textured plastics, paper-jacketed pipes, powder-coated surfaces)
- Adheres to “difficult” low-surface energy items (PVC piping, blow-molded equipment cases, ABS plastics, recycled plastics)

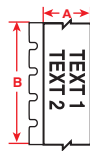

Figure 33



### Facility and Safety Applications:

- 5S Labels
- Pipe Markers
- Safety & Warning Labels
- Equipment & Panel Labels
- Arc Flash & Chemical Labels
- And More!

Service temp: -40°F to 180°F Application temp: 0°F to 180°F  
Average Outdoor Durability: 8-10 year outdoor vinyl label durability.  
Agency approvals:

Fits Printer Model(s)	Diagram	Catalog #	B#	Color	Label Width A Inch (mm)	Roll Length B Feet (m)	Labels Per Roll	Rec. Ribbon
BBP31, BBP33	Fig. 33	B30C-500-595-WT	B-595	White	0.500 (12.7)	100ft. (30.5m)	1 roll (cont.)	B30-R10000
BBP31, BBP33	Fig. 33	B30C-1125-595-WT	B-595	White	1.125 (28.6)	100ft. (30.5m)	1 roll (cont.)	B30-R10000
BBP31, BBP33	Fig. 33	B30C-2250-595-WT	B-595	White	2.250 (57.5)	100ft. (30.5m)	1 roll (cont.)	B30-R10000
BBP31, BBP33	Fig. 33	B30C-3000-595-WT	B-595	White	3.000 (76.2)	100ft. (30.5m)	1 roll (cont.)	B30-R10000
BBP31, BBP33	Fig. 33	B30C-4000-595-WT	B-595	White	4.000 (101.6)	100ft. (30.5m)	1 roll (cont.)	B30-R10000
BBP31, BBP33	Fig. 33	B30C-500-595-YL	B-595	Yellow	0.500 (12.7)	100ft. (30.5m)	1 roll (cont.)	B30-R10000
BBP31, BBP33	Fig. 33	B30C-1125-595-YL	B-595	Yellow	1.125 (28.6)	100ft. (30.5m)	1 roll (cont.)	B30-R10000
BBP31, BBP33	Fig. 33	B30C-2250-595-YL	B-595	Yellow	2.250 (57.5)	100ft. (30.5m)	1 roll (cont.)	B30-R10000
BBP31, BBP33	Fig. 33	B30C-3000-595-YL	B-595	Yellow	3.000 (76.2)	100ft. (30.5m)	1 roll (cont.)	B30-R10000
BBP31, BBP33	Fig. 33	B30C-4000-595-YL	B-595	Yellow	4.000 (101.6)	100ft. (30.5m)	1 roll (cont.)	B30-R10000
BBP31, BBP33	Fig. 33	B30C-500-595-RD	B-595	Red	0.500 (12.7)	100ft. (30.5m)	1 roll (cont.)	B30-R10000-WT
BBP31, BBP33	Fig. 33	B30C-1125-595-RD	B-595	Red	1.125 (28.6)	100ft. (30.5m)	1 roll (cont.)	B30-R10000-WT
BBP31, BBP33	Fig. 33	B30C-2250-595-RD	B-595	Red	2.250 (57.5)	100ft. (30.5m)	1 roll (cont.)	B30-R10000-WT
BBP31, BBP33	Fig. 33	B30C-4000-595-RD	B-595	Red	4.000 (101.6)	100ft. (30.5m)	1 roll (cont.)	B30-R10000-WT
BBP31, BBP33	Fig. 33	B30C-500-595-BL	B-595	Blue	0.500 (12.7)	100ft. (30.5m)	1 roll (cont.)	B30-R10000-WT
BBP31, BBP33	Fig. 33	B30C-1125-595-BL	B-595	Blue	1.125 (28.6)	100ft. (30.5m)	1 roll (cont.)	B30-R10000-WT
BBP31, BBP33	Fig. 33	B30C-2250-595-BL	B-595	Blue	2.250 (57.5)	100ft. (30.5m)	1 roll (cont.)	B30-R10000-WT
BBP31, BBP33	Fig. 33	B30C-4000-595-BL	B-595	Blue	4.000 (101.6)	100ft. (30.5m)	1 roll (cont.)	B30-R10000-WT
BBP31, BBP33	Fig. 33	B30C-500-595-GN	B-595	Green	0.500 (12.7)	100ft. (30.5m)	1 roll (cont.)	B30-R10000-WT
BBP31, BBP33	Fig. 33	B30C-1125-595-GN	B-595	Green	1.125 (28.6)	100ft. (30.5m)	1 roll (cont.)	B30-R10000-WT
BBP31, BBP33	Fig. 33	B30C-2250-595-GN	B-595	Green	2.250 (57.5)	100ft. (30.5m)	1 roll (cont.)	B30-R10000-WT
BBP31, BBP33	Fig. 33	B30C-4000-595-GN	B-595	Green	4.000 (101.6)	100ft. (30.5m)	1 roll (cont.)	B30-R10000-WT
BBP31, BBP33	Fig. 33	B30C-500-595-OR	B-595	Orange	0.500 (12.7)	100ft. (30.5m)	1 roll (cont.)	B30-R10000
BBP31, BBP33	Fig. 33	B30C-1125-595-OR	B-595	Orange	1.125 (28.6)	100ft. (30.5m)	1 roll (cont.)	B30-R10000
BBP31, BBP33	Fig. 33	B30C-2250-595-OR	B-595	Orange	2.250 (57.5)	100ft. (30.5m)	1 roll (cont.)	B30-R10000
BBP31, BBP33	Fig. 33	B30C-4000-595-OR	B-595	Orange	4.000 (101.6)	100ft. (30.5m)	1 roll (cont.)	B30-R10000
BBP31, BBP33	Fig. 33	B30C-500-595-BK	B-595	Black	0.500 (12.7)	100ft. (30.5m)	1 roll (cont.)	B30-R10000-WT
BBP31, BBP33	Fig. 33	B30C-1125-595-BK	B-595	Black	1.125 (28.6)	100ft. (30.5m)	1 roll (cont.)	B30-R10000-WT
BBP31, BBP33	Fig. 33	B30C-2250-595-BK	B-595	Black	2.250 (57.5)	100ft. (30.5m)	1 roll (cont.)	B30-R10000-WT
BBP31, BBP33	Fig. 33	B30C-4000-595-BK	B-595	Black	4.000 (101.6)	100ft. (30.5m)	1 roll (cont.)	B30-R10000-WT
BBP31, BBP33	Fig. 33	B30C-500-595-BR	B-595	Brown	0.500 (12.7)	100ft. (30.5m)	1 roll (cont.)	B30-R10000-WT
BBP31, BBP33	Fig. 33	B30C-1125-595-BR	B-595	Brown	1.125 (28.6)	100ft. (30.5m)	1 roll (cont.)	B30-R10000-WT
BBP31, BBP33	Fig. 33	B30C-2250-595-BR	B-595	Brown	2.250 (57.5)	100ft. (30.5m)	1 roll (cont.)	B30-R10000-WT
BBP31, BBP33	Fig. 33	B30C-4000-595-BR	B-595	Brown	4.000 (101.6)	100ft. (30.5m)	1 roll (cont.)	B30-R10000-WT
BBP31, BBP33	Fig. 33	B30C-500-595-GD	B-595	Gold	0.500 (12.7)	100ft. (30.5m)	1 roll (cont.)	B30-R10000
BBP31, BBP33	Fig. 33	B30C-1125-595-GD	B-595	Gold	1.125 (28.6)	100ft. (30.5m)	1 roll (cont.)	B30-R10000
BBP31, BBP33	Fig. 33	B30C-2250-595-GD	B-595	Gold	2.250 (57.5)	100ft. (30.5m)	1 roll (cont.)	B30-R10000
BBP31, BBP33	Fig. 33	B30C-4000-595-GD	B-595	Gold	4.000 (101.6)	100ft. (30.5m)	1 roll (cont.)	B30-R10000
BBP31, BBP33	Fig. 33	B30C-500-595-GY	B-595	Gray	0.500 (12.7)	100ft. (30.5m)	1 roll (cont.)	B30-R10000
BBP31, BBP33	Fig. 33	B30C-1125-595-GY	B-595	Gray	1.125 (28.6)	100ft. (30.5m)	1 roll (cont.)	B30-R10000
BBP31, BBP33	Fig. 33	B30C-2250-595-GY	B-595	Gray	2.250 (57.5)	100ft. (30.5m)	1 roll (cont.)	B30-R10000
BBP31, BBP33	Fig. 33	B30C-4000-595-GY	B-595	Gray	4.000 (101.6)	100ft. (30.5m)	1 roll (cont.)	B30-R10000
BBP31, BBP33	Fig. 33	B30C-500-595-PL	B-595	Purple	0.500 (12.7)	100ft. (30.5m)	1 roll (cont.)	B30-R10000-WT
BBP31, BBP33	Fig. 33	B30C-1125-595-PL	B-595	Purple	1.125 (28.6)	100ft. (30.5m)	1 roll (cont.)	B30-R10000-WT
BBP31, BBP33	Fig. 33	B30C-2250-595-PL	B-595	Purple	2.250 (57.5)	100ft. (30.5m)	1 roll (cont.)	B30-R10000-WT
BBP31, BBP33	Fig. 33	B30C-4000-595-PL	B-595	Purple	4.000 (101.6)	100ft. (30.5m)	1 roll (cont.)	B30-R10000-WT
BBP31, BBP33	Fig. 33	B30C-500-595-CL	B-595	Clear	0.500 (12.7)	100ft. (30.5m)	1 roll (cont.)	B30-R10000
BBP31, BBP33	Fig. 33	B30C-1125-595-CL	B-595	Clear	1.125 (28.6)	100ft. (30.5m)	1 roll (cont.)	B30-R10000
BBP31, BBP33	Fig. 33	B30C-2250-595-CL	B-595	Clear	2.250 (57.5)	100ft. (30.5m)	1 roll (cont.)	B30-R10000
BBP31, BBP33	Fig. 33	B30C-4000-595-CL	B-595	Clear	4.000 (101.6)	100ft. (30.5m)	1 roll (cont.)	B30-R10000

U.S. Patent Nos. 5,823,689; 6,570,602. Additional Patents Pending.

View all BBP<sup>®</sup>33 and BBP<sup>®</sup>33 Print Ribbon parts on page 379.

## Low-Halide Polyester (B-569)

- Low-halide content for labeling stainless steel pipes and surfaces
- Applies best to very smooth surfaces and ideal for mounting to rigid panels

Service temp: -40°F to 212°F Application temp: 0°F to 212°F  
Average Outdoor Durability: 3-5 years

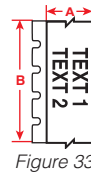

Fits Printer Model(s)	Diagram	Catalog #	B#	Color	Label Width A Inch (mm)	Roll Length B Feet (m)	Labels Per Roll	Rec. Ribbon
BBP31, BBP33	Fig. 33	B30C-500-569-WT	B-569	White	0.500 (12.7)	100ft. (30.5m)	1 roll (cont.)	B30-R10000
BBP31, BBP33	Fig. 33	B30C-1125-569-WT	B-569	White	1.125 (28.6)	100ft. (30.5m)	1 roll (cont.)	B30-R10000
BBP31, BBP33	Fig. 33	B30C-2250-569-WT	B-569	White	2.250 (57.5)	100ft. (30.5m)	1 roll (cont.)	B30-R10000
BBP31, BBP33	Fig. 33	B30C-3000-569-WT	B-569	White	3.000 (76.2)	100ft. (30.5m)	1 roll (cont.)	B30-R10000
BBP31, BBP33	Fig. 33	B30C-4000-569-WT	B-569	White	4.000 (101.6)	100ft. (30.5m)	1 roll (cont.)	B30-R10000
BBP31, BBP33	Fig. 33	B30C-500-569-YL	B-569	Yellow	0.500 (12.7)	100ft. (30.5m)	1 roll (cont.)	B30-R10000
BBP31, BBP33	Fig. 33	B30C-1125-569-YL	B-569	Yellow	1.125 (28.6)	100ft. (30.5m)	1 roll (cont.)	B30-R10000
BBP31, BBP33	Fig. 33	B30C-2250-569-YL	B-569	Yellow	2.250 (57.5)	100ft. (30.5m)	1 roll (cont.)	B30-R10000
BBP31, BBP33	Fig. 33	B30C-4000-569-YL	B-569	Yellow	4.000 (101.6)	100ft. (30.5m)	1 roll (cont.)	B30-R10000
BBP31, BBP33	Fig. 33	B30C-500-569-RD	B-569	Red	0.500 (12.7)	100ft. (30.5m)	1 roll (cont.)	B30-R10000-WT
BBP31, BBP33	Fig. 33	B30C-1125-569-RD	B-569	Red	1.125 (28.6)	100ft. (30.5m)	1 roll (cont.)	B30-R10000-WT
BBP31, BBP33	Fig. 33	B30C-2250-569-RD	B-569	Red	2.250 (57.5)	100ft. (30.5m)	1 roll (cont.)	B30-R10000-WT
BBP31, BBP33	Fig. 33	B30C-4000-569-RD	B-569	Red	4.000 (101.6)	100ft. (30.5m)	1 roll (cont.)	B30-R10000-WT
BBP31, BBP33	Fig. 33	B30C-500-569-BL	B-569	Blue	0.500 (12.7)	100ft. (30.5m)	1 roll (cont.)	B30-R10000-WT
BBP31, BBP33	Fig. 33	B30C-1125-569-BL	B-569	Blue	1.125 (28.6)	100ft. (30.5m)	1 roll (cont.)	B30-R10000-WT
BBP31, BBP33	Fig. 33	B30C-2250-569-BL	B-569	Blue	2.250 (57.5)	100ft. (30.5m)	1 roll (cont.)	B30-R10000-WT
BBP31, BBP33	Fig. 33	B30C-4000-569-BL	B-569	Blue	4.000 (101.6)	100ft. (30.5m)	1 roll (cont.)	B30-R10000-WT
BBP31, BBP33	Fig. 33	B30C-500-569-LB	B-569	Light Blue	0.500 (12.7)	100ft. (30.5m)	1 roll (cont.)	B30-R10000
BBP31, BBP33	Fig. 33	B30C-1125-569-LB	B-569	Light Blue	1.125 (28.6)	100ft. (30.5m)	1 roll (cont.)	B30-R10000
BBP31, BBP33	Fig. 33	B30C-2250-569-LB	B-569	Light Blue	2.250 (57.5)	100ft. (30.5m)	1 roll (cont.)	B30-R10000
BBP31, BBP33	Fig. 33	B30C-4000-569-LB	B-569	Light Blue	4.000 (101.6)	100ft. (30.5m)	1 roll (cont.)	B30-R10000
BBP31, BBP33	Fig. 33	B30C-500-569-SB	B-569	Sky Blue	0.500 (12.7)	100ft. (30.5m)	1 roll (cont.)	B30-R10000
BBP31, BBP33	Fig. 33	B30C-1125-569-SB	B-569	Sky Blue	1.125 (28.6)	100ft. (30.5m)	1 roll (cont.)	B30-R10000
BBP31, BBP33	Fig. 33	B30C-2250-569-SB	B-569	Sky Blue	2.250 (57.5)	100ft. (30.5m)	1 roll (cont.)	B30-R10000
BBP31, BBP33	Fig. 33	B30C-4000-569-SB	B-569	Sky Blue	4.000 (101.6)	100ft. (30.5m)	1 roll (cont.)	B30-R10000
BBP31, BBP33	Fig. 33	B30C-500-569-GN	B-569	Green	0.500 (12.7)	100ft. (30.5m)	1 roll (cont.)	B30-R10000-WT
BBP31, BBP33	Fig. 33	B30C-1125-569-GN	B-569	Green	1.125 (28.6)	100ft. (30.5m)	1 roll (cont.)	B30-R10000-WT
BBP31, BBP33	Fig. 33	B30C-2250-569-GN	B-569	Green	2.250 (57.5)	100ft. (30.5m)	1 roll (cont.)	B30-R10000-WT
BBP31, BBP33	Fig. 33	B30C-4000-569-GN	B-569	Green	4.000 (101.6)	100ft. (30.5m)	1 roll (cont.)	B30-R10000-WT
BBP31, BBP33	Fig. 33	B30C-500-569-OR	B-569	Orange	0.500 (12.7)	100ft. (30.5m)	1 roll (cont.)	B30-R10000
BBP31, BBP33	Fig. 33	B30C-1125-569-OR	B-569	Orange	1.125 (28.6)	100ft. (30.5m)	1 roll (cont.)	B30-R10000
BBP31, BBP33	Fig. 33	B30C-2250-569-OR	B-569	Orange	2.250 (57.5)	100ft. (30.5m)	1 roll (cont.)	B30-R10000
BBP31, BBP33	Fig. 33	B30C-4000-569-OR	B-569	Orange	4.000 (101.6)	100ft. (30.5m)	1 roll (cont.)	B30-R10000
BBP31, BBP33	Fig. 33	B30C-500-569-BK	B-569	Black	0.500 (12.7)	100ft. (30.5m)	1 roll (cont.)	B30-R10000-WT
BBP31, BBP33	Fig. 33	B30C-1125-569-BK	B-569	Black	1.125 (28.6)	100ft. (30.5m)	1 roll (cont.)	B30-R10000-WT
BBP31, BBP33	Fig. 33	B30C-2250-569-BK	B-569	Black	2.250 (57.5)	100ft. (30.5m)	1 roll (cont.)	B30-R10000-WT
BBP31, BBP33	Fig. 33	B30C-4000-569-BK	B-569	Black	4.000 (101.6)	100ft. (30.5m)	1 roll (cont.)	B30-R10000-WT
BBP31, BBP33	Fig. 33	B30C-500-569-BR	B-569	Brown	0.500 (12.7)	100ft. (30.5m)	1 roll (cont.)	B30-R10000-WT
BBP31, BBP33	Fig. 33	B30C-1125-569-BR	B-569	Brown	1.125 (28.6)	100ft. (30.5m)	1 roll (cont.)	B30-R10000-WT
BBP31, BBP33	Fig. 33	B30C-2250-569-BR	B-569	Brown	2.250 (57.5)	100ft. (30.5m)	1 roll (cont.)	B30-R10000-WT
BBP31, BBP33	Fig. 33	B30C-4000-569-BR	B-569	Brown	4.000 (101.6)	100ft. (30.5m)	1 roll (cont.)	B30-R10000-WT
BBP31, BBP33	Fig. 33	B30C-500-569-OC	B-569	Ochre	0.500 (12.7)	100ft. (30.5m)	1 roll (cont.)	B30-R10000
BBP31, BBP33	Fig. 33	B30C-1125-569-OC	B-569	Ochre	1.125 (28.6)	100ft. (30.5m)	1 roll (cont.)	B30-R10000
BBP31, BBP33	Fig. 33	B30C-2250-569-OC	B-569	Ochre	2.250 (57.5)	100ft. (30.5m)	1 roll (cont.)	B30-R10000
BBP31, BBP33	Fig. 33	B30C-4000-569-OC	B-569	Ochre	4.000 (101.6)	100ft. (30.5m)	1 roll (cont.)	B30-R10000
BBP31, BBP33	Fig. 33	B30C-500-569-TN	B-569	Tan	0.500 (12.7)	100ft. (30.5m)	1 roll (cont.)	B30-R10000
BBP31, BBP33	Fig. 33	B30C-1125-569-TN	B-569	Tan	1.125 (28.6)	100ft. (30.5m)	1 roll (cont.)	B30-R10000
BBP31, BBP33	Fig. 33	B30C-2250-569-TN	B-569	Tan	2.250 (57.5)	100ft. (30.5m)	1 roll (cont.)	B30-R10000
BBP31, BBP33	Fig. 33	B30C-4000-569-TN	B-569	Tan	4.000 (101.6)	100ft. (30.5m)	1 roll (cont.)	B30-R10000
BBP31, BBP33	Fig. 33	B30C-500-569-GY	B-569	Gray	0.500 (12.7)	100ft. (30.5m)	1 roll (cont.)	B30-R10000
BBP31, BBP33	Fig. 33	B30C-1125-569-GY	B-569	Gray	1.125 (28.6)	100ft. (30.5m)	1 roll (cont.)	B30-R10000
BBP31, BBP33	Fig. 33	B30C-2250-569-GY	B-569	Gray	2.250 (57.5)	100ft. (30.5m)	1 roll (cont.)	B30-R10000
BBP31, BBP33	Fig. 33	B30C-4000-569-GY	B-569	Gray	4.000 (101.6)	100ft. (30.5m)	1 roll (cont.)	B30-R10000
BBP31, BBP33	Fig. 33	B30C-500-569-PL	B-569	Purple	0.500 (12.7)	100ft. (30.5m)	1 roll (cont.)	B30-R10000-WT
BBP31, BBP33	Fig. 33	B30C-1125-569-PL	B-569	Purple	1.125 (28.6)	100ft. (30.5m)	1 roll (cont.)	B30-R10000-WT
BBP31, BBP33	Fig. 33	B30C-2250-569-PL	B-569	Purple	2.250 (57.5)	100ft. (30.5m)	1 roll (cont.)	B30-R10000-WT
BBP31, BBP33	Fig. 33	B30C-4000-569-PL	B-569	Purple	4.000 (101.6)	100ft. (30.5m)	1 roll (cont.)	B30-R10000-WT
BBP31, BBP33	Fig. 33	B30C-500-569-PK	B-569	Pink	0.500 (12.7)	100ft. (30.5m)	1 roll (cont.)	B30-R10000
BBP31, BBP33	Fig. 33	B30C-1125-569-PK	B-569	Pink	1.125 (28.6)	100ft. (30.5m)	1 roll (cont.)	B30-R10000
BBP31, BBP33	Fig. 33	B30C-2250-569-PK	B-569	Pink	2.250 (57.5)	100ft. (30.5m)	1 roll (cont.)	B30-R10000
BBP31, BBP33	Fig. 33	B30C-4000-569-PK	B-569	Pink	4.000 (101.6)	100ft. (30.5m)	1 roll (cont.)	B30-R10000
BBP31, BBP33	Fig. 33	B30C-500-569-CL	B-569	Clear	0.500 (12.7)	100ft. (30.5m)	1 roll (cont.)	B30-R10000
BBP31, BBP33	Fig. 33	B30C-1125-569-CL	B-569	Clear	1.125 (28.6)	100ft. (30.5m)	1 roll (cont.)	B30-R10000
BBP31, BBP33	Fig. 33	B30C-2250-569-CL	B-569	Clear	2.250 (57.5)	100ft. (30.5m)	1 roll (cont.)	B30-R10000
BBP31, BBP33	Fig. 33	B30C-4000-569-CL	B-569	Clear	4.000 (101.6)	100ft. (30.5m)	1 roll (cont.)	B30-R10000

View all BBP®33 and BBP®33 Print Ribbon parts on page 379.



# BBP<sup>®</sup>31 and BBP<sup>®</sup>33 Materials

BradyID.com/bbp31

## Pre-Printed Pre-Cut Blank Sign Headers (B-595)

- Allows printer to create multicolor signs fast - in a single print pass
- Headers meet NFPA 70E, OSHA 1910.145 and ASME/ANSI Z535 standards
- Indoor/outdoor grade material conforms to rough, highly textured, and "difficult to adhere to" surfaces

Service temp: -40°F to 180°F Application temp: 0°F to 180°F  
Average Outdoor Durability: 8-10 years  
Agency approvals: RoHS

Use these supplies with templates in the BBP<sup>®</sup>33 printer and Brady Workstation App or MarkWare<sup>™</sup> Software for arc flash labels and safety warning labels

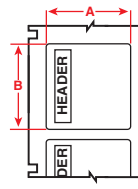

Figure 70



Fits Printer Model(s)	Diagram	Catalog #	B#	Material	Header	Label Height A Inch (mm)	Label Width B Inch (mm)	Labels Per Row	Labels Per Roll	Rec. Ribbon
BBP31, BBP33	Fig. 70	B30-241-595-OSHADA	B-595	Vinyl		2.250 (57.5)	3.000 (76.2)	1	300	B30-R10000
BBP31, BBP33	Fig. 70	B30-25-595-OSHADA	B-595	Vinyl		4.000 (101.6)	6.000 (152.4)	1	175	B30-R10000
BBP31, BBP33	Fig. 70	B30-241-595-OSHACA	B-595	Vinyl		2.250 (57.5)	3.000 (76.2)	1	300	B30-R10000
BBP31, BBP33	Fig. 70	B30-25-595-OSHACA	B-595	Vinyl		4.000 (101.6)	6.000 (152.4)	1	175	B30-R10000
BBP31, BBP33	Fig. 70	B30-241-595-ANSICA	B-595	Vinyl		2.250 (57.5)	3.000 (76.2)	1	300	B30-R10000
BBP31, BBP33	Fig. 70	B30-25-595-ANSICA	B-595	Vinyl		4.000 (101.6)	6.000 (152.4)	1	175	B30-R10000
BBP31, BBP33	Fig. 70	B30-241-595-ANSIDA	B-595	Vinyl		2.250 (57.5)	3.000 (76.2)	1	300	B30-R10000
BBP31, BBP33	Fig. 70	B30-25-595-ANSIDA	B-595	Vinyl		4.000 (101.6)	6.000 (152.4)	1	175	B30-R10000
BBP31, BBP33	Fig. 70	B30-241-595-ANSIWA	B-595	Vinyl		2.250 (57.5)	3.000 (76.2)	1	300	B30-R10000
BBP31, BBP33	Fig. 70	B30-25-595-ANSIWA	B-595	Vinyl		4.000 (101.6)	6.000 (152.4)	1	175	B30-R10000
BBP31, BBP33	Fig. 70	B30-241-595-ANSINO	B-595	Vinyl		2.250 (57.5)	3.000 (76.2)	1	300	B30-R10000
BBP31, BBP33	Fig. 70	B30-25-595-ANSINO	B-595	Vinyl		4.000 (101.6)	6.000 (152.4)	1	175	B30-R10000
BBP31, BBP33	Fig. 70	B30-242-595-BLNKWT	B-595	Vinyl		1.125 (28.6) *	2.850 (72.4)	1	300	B30-R10000
BBP31, BBP33	Fig. 70	B30-241-595-BLNKWT	B-595	Vinyl		2.250 (57.5)	3.000 (76.2)	1	300	B30-R10000
BBP31, BBP33	Fig. 70	B30-219-595-BLNKWT	B-595	Vinyl		2.250 (57.5) *	3.850 (97.8)	1	250	B30-R10000
BBP31, BBP33	Fig. 70	B30-25-595-BLNKWT	B-595	Vinyl		4.000 (101.6)	6.000 (152.4)	1	175	B30-R10000
BBP31, BBP33	Fig. 70	B30-241-595-BLNKYL	B-595	Vinyl		2.250 (57.5)	3.000 (76.2)	1	300	B30-R10000
BBP31, BBP33	Fig. 70	B30-25-595-BLNKYL	B-595	Vinyl		4.000 (101.6)	6.000 (152.4)	1	175	B30-R10000

\*Label pre-sized to fit blank rigid valve tags on page 400, but can also be used on its own as general purpose label. Visit BradyID.com for information on Valve Tags.

## Non-Adhesive Pre-Printed & Pre-Cut Safety Tags (B-551)

- Non-adhesive semi rigid card stock
- Tags are pre-cut with hole and chamfered corners
- Micro-perforated between tags to separate cleanly
- Snap-in plastic grommets available for extra strength around mounting hole

Service temp: -40°F to 180°F Application temp: 0°F to 180°F  
Average Outdoor Durability: 8-10 years

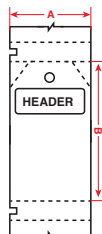

Figure 69



Fits Printer Model(s)	Diagram	Catalog #	B#	Header	Tag Width A Inch (mm)	Tag Height B Inch (mm)	Tags Per Row	Tags Per Roll	Rec. Ribbon
BBP31, BBP33	Fig. 69	B30-255-551-ANSIDA	B-551		3.250 (82.6)	5.750 (146.1)	1	100	B30-R10000
BBP31, BBP33	Fig. 69	B30-255-551-OSHADA	B-551		3.250 (82.6)	5.750 (146.1)	1	100	B30-R10000
BBP31, BBP33	Fig. 69	B30-255-551-ANSICA	B-551		3.250 (82.6)	5.750 (146.1)	1	100	B30-R10000
BBP31, BBP33	Fig. 69	B30-255-551-WHT	B-551		3.250 (82.6)	5.750 (146.1)	1	100	B30-R10000

View all BBP<sup>®</sup>33 and BBP<sup>®</sup>33 Print Ribbon parts on page 379.



## ToughWash™ Washdown Resistant Labels (B-854, B-855)

- Withstands pressures of high heat, harsh chemicals and numerous washdown cycles
- B-854 offers metal detectable layer to detect foreign debris in food stream
- Legible and long-lasting for even the toughest washdown cycles
- Ideal for use in the Food & Beverage industry

Service temp: -40°F to 230°F  
Agency approvals: RoHS

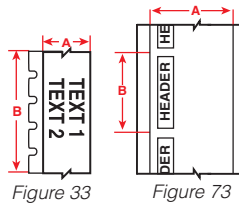

Fits Printer Model(s)	Diagram	Catalog #	B#	Color	Label Width A Inch (mm)	Length B Inch (mm)	Labels Per Roll	Rec. Ribbon
<b>B-854 ToughWash™ Metal Detectable Material</b>								
BBP31, BBP33	Fig. 33	B30C-4000-854-WT	B-854		4.000 (101.06)	50ft. (15.2 m)	1 roll (cont.)	B30-R6000
BBP31, BBP33	Fig. 33	B30C-4000-854-YL	B-854		4.000 (101.06)	50ft. (15.2 m)	1 roll (cont.)	B30-R6000
BBP31, BBP33	Fig. 73	B30C-4000-854-WARN	B-854		4.000 (101.06)	6.250 (158.8)	100	B30-R6000
BBP31, BBP33	Fig. 73	B30C-4000-854-DANG	B-854		4.000 (101.06)	6.250 (158.8)	100	B30-R6000
BBP31, BBP33	Fig. 73	B30C-4000-854-CAUT	B-854		4.000 (101.06)	6.250 (158.8)	100	B30-R6000
<b>B-855 ToughWash™ Material</b>								
BBP31, BBP33	Fig. 33	B30C-1125-855-WT	B-855		1.125 (28.6)	50ft. (15.2 m)	1 roll (cont.)	B30-R6000
BBP31, BBP33	Fig. 33	B30C-2250-855-WT	B-855		2.250 (57.5)	50ft. (15.2 m)	1 roll (cont.)	B30-R6000
BBP31, BBP33	Fig. 33	B30C-4000-855-WT	B-855		4.000 (101.06)	50ft. (15.2 m)	1 roll (cont.)	B30-R6000
BBP31, BBP33	Fig. 33	B30C-1125-855-YL	B-855		1.125 (28.6)	50ft. (15.2 m)	1 roll (cont.)	B30-R6000
BBP31, BBP33	Fig. 33	B30C-2250-855-YL	B-855		2.250 (57.5)	50ft. (15.2 m)	1 roll (cont.)	B30-R6000
BBP31, BBP33	Fig. 33	B30C-4000-855-YL	B-855		4.000 (101.06)	50ft. (15.2 m)	1 roll (cont.)	B30-R6000
BBP31, BBP33	Fig. 73	B30C-4000-855-WARN	B-855		4.000 (101.06)	6.250 (158.8)	100	B30-R6000
BBP31, BBP33	Fig. 73	B30C-4000-855-DANG	B-855		4.000 (101.06)	6.250 (158.8)	100	B30-R6000
BBP31, BBP33	Fig. 73	B30C-4000-855-CAUT	B-855		4.000 (101.06)	6.250 (158.8)	100	B30-R6000

## Non-Adhesive Continuous Tag Stock (B-551)

- For safety, lockout and general purpose hang-tagging
- Non-adhesive, semi-rigid tag stock
- Easy to hole-punch; optional snap-in grommets available
- Meets OSHA 50 lb. pullout spec for lockout tags

Service temp: -40°F to 193°F Average Outdoor Durability: up to 2 years  
Thickness: 0.35mm



Fits Printer Model(s)	Diagram	Catalog #	B#	Color	Tag Width A Inch (mm)	Roll Length B Feet (m)	Tags Per Roll	Rec. Ribbon
BBP31, BBP33	Fig. 33	B30C-2500-551-WT	B-551	White	2.500 (63.5)	50ft. (15.2m)	1 roll (cont.)	B30-R10000
BBP31, BBP33	Fig. 33	B30C-3250-551-WT	B-551	White	3.250 (82.6)	50ft. (15.2m)	1 roll (cont.)	B30-R10000
BBP31, BBP33	Fig. 33	B30C-4250-551-WT	B-551	White	4.250 (107.9)	50ft. (15.2m)	1 roll (cont.)	B30-R10000

View all BBP<sup>®</sup>33 and BBP<sup>®</sup>33 Print Ribbon parts on page 379.



# BBP<sup>®</sup>31 and BBP<sup>®</sup>33 Materials

BradyID.com/bbp31

## Retro Reflective Tape (B-584)

- Highly reflective material shines back brightly when struck by light
- Ideal for labeling outdoor utility poles and pedestals, hard hats, jobsite equipment and roof-top equipment
- Recommended for low light or inclement weather conditions

Service temp: -40°F to 158°F

Application temp: 0°F to 158°F (yellow & orange), 50°F to 158°F (silver)

Average Outdoor Durability: 4 to 6 years

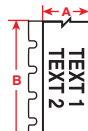

Figure 33



Fits Printer Model(s)	Diagram	Catalog #	B#	Color	Label Width A Inch (mm)	Roll Length B Feet (m)	Labels Per Roll	Rec. Ribbon
BBP31, BBP33	Fig. 33	B30C-1125-584-SL	B-584	Silver	1.125 (28.6)	50ft. (15.2m)	1 roll (cont.)	B30-R10000
BBP31, BBP33	Fig. 33	B30C-2250-584-SL	B-584	Silver	2.250 (57.5)	50ft. (15.2m)	1 roll (cont.)	B30-R10000
BBP31, BBP33	Fig. 33	B30C-4000-584-SL	B-584	Silver	4.000 (101.6)	50ft. (15.2m)	1 roll (cont.)	B30-R10000
BBP31, BBP33	Fig. 33	B30C-1125-584-YL	B-584	Yellow	1.125 (28.6)	50ft. (15.2m)	1 roll (cont.)	B30-R10000
BBP31, BBP33	Fig. 33	B30C-2250-584-YL	B-584	Yellow	2.250 (57.5)	50ft. (15.2m)	1 roll (cont.)	B30-R10000
BBP31, BBP33	Fig. 33	B30C-4000-584-YL	B-584	Yellow	4.000 (101.6)	50ft. (15.2m)	1 roll (cont.)	B30-R10000
BBP31, BBP33	Fig. 33	B30C-1125-584-OR	B-584	Orange	1.125 (28.6)	50ft. (15.2m)	1 roll (cont.)	B30-R10000
BBP31, BBP33	Fig. 33	B30C-2250-584-OR	B-584	Orange	2.250 (57.5)	50ft. (15.2m)	1 roll (cont.)	B30-R10000
BBP31, BBP33	Fig. 33	B30C-4000-584-OR	B-584	Orange	4.000 (101.6)	50ft. (15.2m)	1 roll (cont.)	B30-R10000

## BradyGlo™ High-Intensity Photoluminescent Tape (B-526)

- For glow-in-the-dark identification up to 10 hours
- Designed for directional and evacuation marking and equipment marking
- Ideal for marking emergency utility shut-offs, fire extinguishers, alarm pulls, and vital equipment controls
- Complies with indoor use requirements specified in RS 6-1 and 6-1A of New York Local Law 26

Service temp: -40°F to 140°F Application temp: 40°F to 140°F

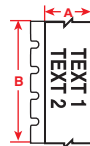

Figure 33



Fits Printer Model(s)	Diagram	Catalog #	B#	Color	Label Width A Inch (mm)	Roll Length B Feet (m)	Labels Per Roll	Rec. Ribbon
BBP31, BBP33	Fig. 33	B30C-1125-526	B-526	Luminous Green	1.125 (28.6)	50ft. (15.2m)	1 roll (cont.)	B30-R10000
BBP31, BBP33	Fig. 33	B30C-2250-526	B-526	Luminous Green	2.250 (57.5)	50ft. (15.2m)	1 roll (cont.)	B30-R10000
BBP31, BBP33	Fig. 33	B30C-4000-526	B-526	Luminous Green	4.000 (101.6)	50ft. (15.2m)	1 roll (cont.)	B30-R10000

## Printable Magnetic Supply (B-509)

- Easiest and quickest material for removing and repositioning.
- Non-adhesive magnetic material that can be printed on directly
- Ideal for reusable, repositionable, and lean / 5S identification applications

Service temp: 0°F to 158°F  
Average Outdoor Durability: 3 to 5 years

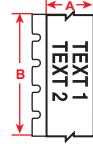

Figure 33



Fits Printer Model(s)	Diagram	Catalog #	B#	Color	Label Width A Inch (mm)	Roll Length B Feet (m)	Labels Per Roll	Rec. Ribbon
BBP31, BBP33	Fig. 33	B30C-2500-509-WT	B-509	White	2.500 (63.5)	25ft (7.62m)	1 roll (cont.)	B30-R10000
BBP31, BBP33	Fig. 33	B30C-4250-509-WT	B-509	White	4.250 (107.8)	25ft (7.62m)	1 roll (cont.)	B30-R10000
BBP31, BBP33	Fig. 33	B30C-2500-509-YL	B-509	Yellow	2.500 (63.5)	25ft (7.62m)	1 roll (cont.)	B30-R10000
BBP31, BBP33	Fig. 33	B30C-4250-509-YL	B-509	Yellow	4.250 (107.8)	25ft (7.62m)	1 roll (cont.)	B30-R10000

## Repositionable Vinyl (B-581)

- Aggressive adhesive stays in place but removes cleanly without leaving adhesive residue
- Ideal for temporary, removable, and repositionable labels, like 5S and lean inventory labels

Service temp: -40°F to 180°F Application temp: 50°F to 180°F  
Average Outdoor Durability: 5 years

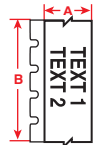

Figure 33



Fits Printer Model(s)	Diagram	Catalog #	B#	Color	Label Width A Inch (mm)	Roll Length B Feet (m)	Labels Per Roll	Rec. Ribbon
BBP31, BBP33	Fig. 33	B30C-500-581-WT	B-581	White	0.500 (12.7)	100ft. (30.5m)	1 roll (cont.)	B30-R10000
BBP31, BBP33	Fig. 33	B30C-1125-581-WT	B-581	White	1.125 (28.6)	100ft. (30.5m)	1 roll (cont.)	B30-R10000
BBP31, BBP33	Fig. 33	B30C-2250-581-WT	B-581	White	2.250 (57.5)	100ft. (30.5m)	1 roll (cont.)	B30-R10000
BBP31, BBP33	Fig. 33	B30C-4000-581-WT	B-581	White	4.000 (101.6)	100ft. (30.5m)	1 roll (cont.)	B30-R10000
BBP31, BBP33	Fig. 33	B30C-500-581-YL	B-581	Yellow	0.500 (12.7)	100ft. (30.5m)	1 roll (cont.)	B30-R10000
BBP31, BBP33	Fig. 33	B30C-1125-581-YL	B-581	Yellow	1.125 (28.6)	100ft. (30.5m)	1 roll (cont.)	B30-R10000
BBP31, BBP33	Fig. 33	B30C-2250-581-YL	B-581	Yellow	2.250 (57.5)	100ft. (30.5m)	1 roll (cont.)	B30-R10000
BBP31, BBP33	Fig. 33	B30C-4000-581-YL	B-581	Yellow	4.000 (101.6)	100ft. (30.5m)	1 roll (cont.)	B30-R10000

## Polypropylene Labels (B-425)

- General labeling material for indoor use
- Outstanding chemical and solvent resistance and print performance
- Not recommended for prolonged outdoor use (use B-595 material for 8-10 year outdoor use)

Service temp: -94°F to 212°F  
Agency approvals:

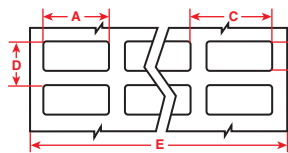

Figure 1

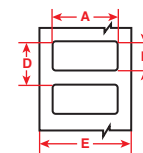

Figure 2



Fits Printer Model(s)	Diagram	Catalog #	B#	Color	Label Width A Inch (mm)	Label Height B Inch (mm)	Horiz. Repeat C Inch (mm)	Vert. Repeat D Inch (mm)	Web Width E Inch (mm)	Labels Per Row	Labels Per Roll	Rec. Ribbon
BBP33 only	Fig. 1	B33-5-425	B-425	White	1.000 (25.4)	0.500 (12.7)	1.075 (27.3)	0.600 (15.2)	3.350 (85.1)	3	5000	B30-R4300
BBP33 only	Fig. 2	B33-17-425	B-425	White	2.000 (50.8)	1.000 (25.4)	-	1.125 (28.6)	2.200 (55.9)	1	1500	B30-R4300
BBP33 only	Fig. 2	B33-18-425	B-425	White	3.000 (76.2)	1.000 (25.4)	-	1.125 (28.6)	3.200 (81.3)	1	1500	B30-R4300
BBP33 only	Fig. 2	B33-19-425	B-425	White	3.000 (76.2)	2.000 (50.8)	-	2.125 (54.0)	3.200 (81.3)	1	500	B30-R4300

View all BBP<sup>®</sup>33 and BBP<sup>®</sup>33 Print Ribbon parts on page 379.



# BBP<sup>®</sup>31 and BBP<sup>®</sup>33 Materials

BradyID.com/bbp31

## Pre-Printed Right-To-Know Chemical Labels (B-595)

- Allows printer to produce 5-color chemical labels in a single print pass
- Indoor/outdoor grade material withstands exposure to moisture, chemicals and handling

Service temp: -40°F to 180°F Application temp: 0°F to 180°F  
Average Outdoor Durability: 8 to 10 years  
Agency approvals: **RoHS**



Fits Printer Model(s)	Catalog #	B#	Legend	Label Height Inch (mm)	Label Width Inch (mm)	Labels Per Row	Labels Per Roll	Rec. Ribbon
BBP31, BBP33	B30-244-595-NFPA	B-595		2.250 (57.5)	2.250 (57.5)	1	365	B30-R10000
BBP31, BBP33	B30-245-595-NFPA	B-595		2.250 (57.5)	4.000 (101.6)	1	240	B30-R10000
BBP31, BBP33	B30-263-595-NFPA	B-595		4.000 (101.6)	6.250 (158.8)	1	170	B30-R10000
BBP31, BBP33	B30-244-595-DIAM	B-595		2.250 (57.5)	2.250 (57.5)	1	365	B30-R10000
BBP31, BBP33	B30-161-595-DIAM	B-595		4.000 (101.6)	4.000 (101.6)	1	240	B30-R10000
BBP31, BBP33	B30-246-595-NFR	B-595		1.125 (28.6)	3.000 (76.2)	1	300	B30-R10000
BBP31, BBP33	B30-244-595-CB	B-595		2.250 (57.5)	2.250 (57.5)	1	365	B30-R10000
BBP31, BBP33	B30-245-595-CB	B-595		2.250 (57.5)	4.000 (101.6)	1	240	B30-R10000
BBP31, BBP33	B30-263-595-CB	B-595		4.000 (101.6)	6.250 (158.8)	1	170	B30-R10000
BBP31, BBP33	B30-244-595-HMIG	B-595		2.250 (57.5)	2.250 (57.5)	1	365	B30-R10000
BBP31, BBP33	B30-246-595-HMIG	B-595		1.125 (28.6)	3.000 (76.2)	1	300	B30-R10000

## Paper Labels (B-424)

- Economical choice for light duty general ID
- White finish and matte topcoat
- Excellent contrast and smear resistance for bar code printing

Service temp: -40°F to 124°F  
Agency approvals: **RoHS**

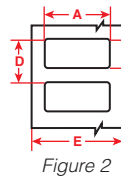

Figure 2



Fits Printer Model(s)	Diagram	Catalog #	B#	Color	Label Width A Inch (mm)	Label Height B Inch (mm)	Horiz. Repeat C Inch (mm)	Vert. Repeat D Inch (mm)	Web Width E Inch (mm)	Labels Per Row	Labels Per Roll	Rec. Ribbon
BBP33 only	Fig. 2	B33-53-424	B-424	White	2.000 (50.8)	0.500 (12.7)	-	0.600 (15.2)	2.200 (55.9)	1	2500	B30-R4300
BBP33 only	Fig. 2	B33-17-424	B-424	White	2.000 (50.8)	1.000 (25.4)	1.125 (28.6)	2.200 (55.9)	-	1	1500	B30-R4300
BBP33 only	Fig. 2	B33-7-424	B-424	White	2.750 (69.9)	1.250 (31.8)	-	1.375 (34.9)	2.950 (74.9)	1	1000	B30-R4300
BBP33 only	Fig. 2	B33-18-424	B-424	White	3.000 (76.2)	1.000 (25.4)	1.125 (28.6)	3.200 (81.3)	-	1	1500	B30-R4300
BBP33 only	Fig. 2	B33-19-424	B-424	White	3.000 (76.2)	2.000 (50.8)	2.125 (54.0)	3.200 (81.3)	-	1	500	B30-R4300
BBP33 only	Fig. 2	B33-20-424	B-424	White	3.000 (76.2)	5.000 (127)	-	5.125 (130.2)	3.200 (81.3)	1	250	B30-R4300
BBP33 only	Fig. 2	B33-55-424	B-424	White	4.000 (101.6)	2.000 (50.8)	-	2.125 (54.0)	4.200 (106.7)	1	750	B30-R4300
BBP33 only	Fig. 2	B33-25-424	B-424	White	4.000 (101.6)	6.000 (152.4)	6.125 (155.6)	4.200 (106.7)	-	1	350	B30-R4300

## Cold Temperature Application Material (B-549)

- Special adhesive permanently adheres to extremely cold surfaces
- Can be applied in -10°F and lasts in -40°F
- Ideal for cold storage warehouses, coolers, freezers, and short-term winter outdoor use

Service temp: -40°F to 212°F Application temp: -10°F to 212°F  
Average Outdoor Durability: Up to 1 year



Figure 33



Fits Printer Model(s)	Diagram	Catalog #	B#	Color	Label Width A Inch (mm)	Roll Length B Feet (m)	Labels Per Roll	Rec. Ribbon
BBP31, BBP33	Fig. 33	B30C-1125-549-WT	B-549	White	1.125 (28.6)	100ft. (30.5m)	1 roll (cont.)	B30-R10000
BBP31, BBP33	Fig. 33	B30C-2250-549-WT	B-549	White	2.250 (57.5)	100ft. (30.5m)	1 roll (cont.)	B30-R10000
BBP31, BBP33	Fig. 33	B30C-4000-549-WT	B-549	White	4.000 (101.6)	100ft. (30.5m)	1 roll (cont.)	B30-R10000
BBP31, BBP33	Fig. 33	B30C-4000-549-YL	B-549	Yellow	1.125 (28.6)	100ft. (30.5m)	1 roll (cont.)	B30-R10000
BBP31, BBP33	Fig. 33	B30C-2250-549-YL	B-549	Yellow	2.250 (57.5)	100ft. (30.5m)	1 roll (cont.)	B30-R10000
BBP31, BBP33	Fig. 33	B30C-1125-549-YL	B-549	Yellow	4.000 (101.6)	100ft. (30.5m)	1 roll (cont.)	B30-R10000

View all BBP<sup>®</sup>33 and BBP<sup>®</sup>33 Print Ribbon parts on page 379.

## Raised Profile Labels - Engraved Plate Substitutes - Push Button Style (B-593)

Costs up to 80% less than engraved legend plates.

- High gloss, polyester label with thick raised profile and ultra-aggressive adhesive (0.70mm thick)
- High performance, low cost substitute to engraved plates
- 10-year outdoor durability rating
- On-demand labeling: labels print out in less than 4 seconds
- 5 push button sizes (including keyed and non-keyed 22.5mm, and 30.5mm hole diameter keyed)

Service temp: -4°F to 212°F Application temp: 50°F to 212°F  
Average Outdoor Durability: Up to 10 years  
Agency approvals:

Note: BBP@31 printers purchased prior to 2012 require a free mechanical rework and firmware upgrade in order to be compatible with the following B-595 Raised Panel Labels. Please contact Technical Support at 1-800-643-8766 for details.

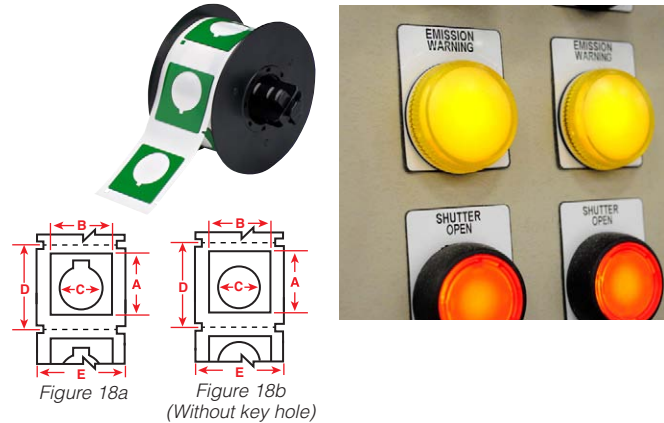

Fits Printer Model(s)	Diagram	Catalog #	B#	Color	Label Height A Inch (mm)	Label Width B Inch (mm)	Hole Diameter C Inch (mm)	Vert. Repeat D Inch (mm)	Web Width E Inch (mm)	Labels Per Row	Labels Per Roll	Rec. Ribbon
BBP31, BBP33	Fig. 18a	B30EP-167-593-WT	B-593	White	1.500 (38.1)	1.200 (30.5)	0.885 (22.5)	1.750 (44.5)	2.500 (63.5)	1	200	B30-R6000
BBP31, BBP33	Fig. 18b	B30EP-167U-593-WT	B-593	White	1.500 (38.1)	1.200 (30.5)	0.885 (22.5)	1.750 (44.5)	2.500 (63.5)	1	200	B30-R6000
BBP31, BBP33	Fig. 18a	B30EP-169-593-WT	B-593	White	1.800 (45.7)	1.800 (45.7)	1.200 (30.5)	2.000 (50.8)	2.500 (63.5)	1	190	B30-R6000
BBP31, BBP33	Fig. 18a	B30EP-168-593-WT	B-593	White	1.900 (48.3)	1.200 (30.5)	0.885 (22.5)	2.125 (54.0)	2.500 (63.5)	1	180	B30-R6000
BBP31, BBP33	Fig. 18a	B30EP-170-593-WT	B-593	White	2.400 (60.9)	2.400 (60.9)	1.200 (30.5)	2.625 (66.7)	3.250 (82.6)	1	145	B30-R6000
BBP31, BBP33	Fig. 18a	B30EP-167-593-YL	B-593	Yellow	1.500 (38.1)	1.200 (30.5)	0.885 (22.5)	1.750 (44.5)	2.500 (63.5)	1	200	B30-R6000
BBP31, BBP33	Fig. 18b	B30EP-167U-593-YL	B-593	Yellow	1.500 (38.1)	1.200 (30.5)	0.885 (22.5)	1.750 (44.5)	2.500 (63.5)	1	200	B30-R6000
BBP31, BBP33	Fig. 18a	B30EP-169-593-YL	B-593	Yellow	1.800 (45.7)	1.800 (45.7)	1.200 (30.5)	2.000 (50.8)	2.500 (63.5)	1	190	B30-R6000
BBP31, BBP33	Fig. 18a	B30EP-168-593-YL	B-593	Yellow	1.900 (48.3)	1.200 (30.5)	0.885 (22.5)	2.125 (54.0)	2.500 (63.5)	1	180	B30-R6000
BBP31, BBP33	Fig. 18a	B30EP-170-593-YL	B-593	Yellow	2.400 (60.9)	2.400 (60.9)	1.200 (30.5)	2.625 (66.7)	3.250 (82.6)	1	145	B30-R6000
BBP31, BBP33	Fig. 18a	B30EP-167-593-BK	B-593	Black	1.500 (38.1)	1.200 (30.5)	0.885 (22.5)	1.750 (44.5)	2.500 (63.5)	1	200	B30-R4400-WT
BBP31, BBP33	Fig. 18b	B30EP-167U-593-BK	B-593	Black	1.500 (38.1)	1.200 (30.5)	0.885 (22.5)	1.750 (44.5)	2.500 (63.5)	1	200	B30-R4400-WT
BBP31, BBP33	Fig. 18a	B30EP-169-593-BK	B-593	Black	1.800 (45.7)	1.800 (45.7)	1.200 (30.5)	2.000 (50.8)	2.500 (63.5)	1	190	B30-R4400-WT
BBP31, BBP33	Fig. 18a	B30EP-168-593-BK	B-593	Black	1.900 (48.3)	1.200 (30.5)	0.885 (22.5)	2.125 (54.0)	2.500 (63.5)	1	180	B30-R4400-WT
BBP31, BBP33	Fig. 18a	B30EP-170-593-BK	B-593	Black	2.400 (60.9)	2.400 (60.9)	1.200 (30.5)	2.625 (66.7)	3.250 (82.6)	1	145	B30-R4400-WT
BBP31, BBP33	Fig. 18a	B30EP-167-593-GN	B-593	Green	1.500 (38.1)	1.200 (30.5)	0.885 (22.5)	1.750 (44.5)	2.500 (63.5)	1	200	B30-R4400-WT
BBP31, BBP33	Fig. 18b	B30EP-167U-593-GN	B-593	Green	1.500 (38.1)	1.200 (30.5)	0.885 (22.5)	1.750 (44.5)	2.500 (63.5)	1	200	B30-R4400-WT
BBP31, BBP33	Fig. 18a	B30EP-169-593-GN	B-593	Green	1.800 (45.7)	1.800 (45.7)	1.200 (30.5)	2.000 (50.8)	2.500 (63.5)	1	190	B30-R4400-WT
BBP31, BBP33	Fig. 18a	B30EP-168-593-GN	B-593	Green	1.900 (48.3)	1.200 (30.5)	0.885 (22.5)	2.125 (54.0)	2.500 (63.5)	1	180	B30-R4400-WT
BBP31, BBP33	Fig. 18a	B30EP-170-593-GN	B-593	Green	2.400 (60.9)	2.400 (60.9)	1.200 (30.5)	2.625 (66.7)	3.250 (82.6)	1	145	B30-R4400-WT
BBP31, BBP33	Fig. 18a	B30EP-167-593-RD	B-593	Red	1.500 (38.1)	1.200 (30.5)	0.885 (22.5)	1.750 (44.5)	2.500 (63.5)	1	200	B30-R4400-WT
BBP31, BBP33	Fig. 18b	B30EP-167U-593-RD	B-593	Red	1.500 (38.1)	1.200 (30.5)	0.885 (22.5)	1.750 (44.5)	2.500 (63.5)	1	200	B30-R4400-WT
BBP31, BBP33	Fig. 18a	B30EP-169-593-RD	B-593	Red	1.800 (45.7)	1.800 (45.7)	1.200 (30.5)	2.000 (50.8)	2.500 (63.5)	1	190	B30-R4400-WT
BBP31, BBP33	Fig. 18a	B30EP-168-593-RD	B-593	Red	1.900 (48.3)	1.200 (30.5)	0.885 (22.5)	2.125 (54.0)	2.500 (63.5)	1	180	B30-R4400-WT
BBP31, BBP33	Fig. 18a	B30EP-170-593-RD	B-593	Red	2.400 (60.9)	2.400 (60.9)	1.200 (30.5)	2.625 (66.7)	3.250 (82.6)	1	145	B30-R4400-WT



### Calculate Your Cost Savings

A 1" x 2" rectangular raised profile label costs approximately **\$0.60**, lasts up to 10 years outdoors and prints in seconds!  
A 22.5mm push button label will cost you about **\$0.32!**

What are you paying for engraved plates?

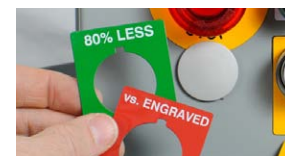

# BBP<sup>®</sup>31 and BBP<sup>®</sup>33 Materials

BradyID.com/bbp31

## Raised Profile Labels - Engraved Plate Substitutes - Rectangular Style (B-593)

Costs up to 80% less than engraved legend plates.

- High gloss, polyester label with thick raised profile and ultra-aggressive adhesive (0.70mm thick)
- Ideal for inside-panel backer board labels and front-of-enclosure labeling
- Up to 80% less than engraved plates and print out in about 4 seconds
- 10-year outdoor durability rating
- 6 colors, 7 rectangular sizes

Service temp: -4°F to 212°F Application temp: 50°F to 212°F  
Average Outdoor Durability: Up to 10 years  
Agency approvals:

Note: BBP<sup>®</sup>31 printers purchased prior to 2012 require a free mechanical rework and firmware upgrade in order to be compatible with the following B-595 Raised Panel Labels. Please contact Technical Support at 1-800-643-8766 for details.

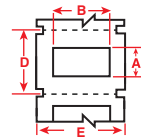

Figure 18c



Fits Printer Model(s)	Diagram	Catalog #	B#	Color	Label Height A Inch (mm)	Label Width B Inch (mm)	Vert. Repeat D Inch (mm)	Web Width E Inch (mm)	Labels Per Row	Labels Per Roll	Rec. Ribbon
BBP31, BBP33	Fig. 18c	B30EP-171-593-WT	B-593	White	0.490 (12.5)	1.060 (26.9)	0.750 (19.1)	1.375 (34.9)	1	500	B30-R6000
BBP31, BBP33	Fig. 18c	B30EP-172-593-WT	B-593	White	0.590 (15.0)	1.770 (45.0)	0.850 (21.6)	2.500 (63.5)	1	450	B30-R6000
BBP31, BBP33	Fig. 18c	B30EP-175-593-WT	B-593	White	0.750 (19.1)	3.000 (76.2)	1.000 (25.4)	3.250 (82.6)	1	375	B30-R6000
BBP31, BBP33	Fig. 18c	B30EP-173-593-WT	B-593	White	1.000 (25.4)	2.000 (50.8)	1.250 (31.8)	2.500 (63.5)	1	300	B30-R6000
BBP31, BBP33	Fig. 18c	B30EP-174-593-WT	B-593	White	1.000 (25.4)	4.000 (101.6)	1.250 (31.8)	4.250 (108.0)	1	300	B30-R6000
BBP31, BBP33	Fig. 18c	B30EP-176-593-WT	B-593	White	1.000 (25.4)	3.000 (76.2)	1.250 (31.8)	3.250 (82.6)	1	300	B30-R6000
BBP31, BBP33	Fig. 18c	B30EP-177-593-WT	B-593	White	2.500 (63.5)	3.000 (76.2)	2.750 (69.9)	3.250 (82.6)	1	125	B30-R6000
BBP31, BBP33	Fig. 18c	B30EP-171-593-YL	B-593	Yellow	0.490 (12.5)	1.060 (26.9)	0.750 (19.1)	1.375 (34.9)	1	500	B30-R6000
BBP31, BBP33	Fig. 18c	B30EP-172-593-YL	B-593	Yellow	0.590 (15.0)	1.770 (45.0)	0.850 (21.6)	2.500 (63.5)	1	450	B30-R6000
BBP31, BBP33	Fig. 18c	B30EP-175-593-YL	B-593	Yellow	0.750 (19.1)	3.000 (76.2)	1.000 (25.4)	3.250 (82.6)	1	375	B30-R6000
BBP31, BBP33	Fig. 18c	B30EP-173-593-YL	B-593	Yellow	1.000 (25.4)	2.000 (50.8)	1.250 (31.8)	2.500 (63.5)	1	300	B30-R6000
BBP31, BBP33	Fig. 18c	B30EP-174-593-YL	B-593	Yellow	1.000 (25.4)	4.000 (101.6)	1.250 (31.8)	4.250 (108.0)	1	300	B30-R6000
BBP31, BBP33	Fig. 18c	B30EP-176-593-YL	B-593	Yellow	1.000 (25.4)	3.000 (76.2)	1.250 (31.8)	3.250 (82.6)	1	300	B30-R6000
BBP31, BBP33	Fig. 18c	B30EP-177-593-YL	B-593	Yellow	2.500 (63.5)	3.000 (76.2)	2.750 (69.9)	3.250 (82.6)	1	125	B30-R6000
BBP31, BBP33	Fig. 18c	B30EP-171-593-BK	B-593	Black	0.490 (12.5)	1.060 (26.9)	0.750 (19.1)	1.375 (34.9)	1	500	B30-R4400-WT
BBP31, BBP33	Fig. 18c	B30EP-172-593-BK	B-593	Black	0.590 (15.0)	1.770 (45.0)	0.850 (21.6)	2.500 (63.5)	1	450	B30-R4400-WT
BBP31, BBP33	Fig. 18c	B30EP-175-593-BK	B-593	Black	0.750 (19.1)	3.000 (76.2)	1.000 (25.4)	3.250 (82.6)	1	375	B30-R4400-WT
BBP31, BBP33	Fig. 18c	B30EP-173-593-BK	B-593	Black	1.000 (25.4)	2.000 (50.8)	1.250 (31.8)	2.500 (63.5)	1	300	B30-R4400-WT
BBP31, BBP33	Fig. 18c	B30EP-174-593-BK	B-593	Black	1.000 (25.4)	4.000 (101.6)	1.250 (31.8)	4.250 (108.0)	1	300	B30-R4400-WT
BBP31, BBP33	Fig. 18c	B30EP-176-593-BK	B-593	Black	1.000 (25.4)	3.000 (76.2)	1.250 (31.8)	3.250 (82.6)	1	300	B30-R4400-WT
BBP31, BBP33	Fig. 18c	B30EP-177-593-BK	B-593	Black	2.500 (63.5)	3.000 (76.2)	2.750 (69.9)	3.250 (82.6)	1	125	B30-R4400-WT
BBP31, BBP33	Fig. 18c	B30EP-171-593-GN	B-593	Green	0.490 (12.5)	1.060 (26.9)	0.750 (19.1)	1.375 (34.9)	1	500	B30-R4400-WT
BBP31, BBP33	Fig. 18c	B30EP-172-593-GN	B-593	Green	0.590 (15.0)	1.770 (45.0)	0.850 (21.6)	2.500 (63.5)	1	450	B30-R4400-WT
BBP31, BBP33	Fig. 18c	B30EP-175-593-GN	B-593	Green	0.750 (19.1)	3.000 (76.2)	1.000 (25.4)	3.250 (82.6)	1	375	B30-R4400-WT
BBP31, BBP33	Fig. 18c	B30EP-173-593-GN	B-593	Green	1.000 (25.4)	2.000 (50.8)	1.250 (31.8)	2.500 (63.5)	1	300	B30-R4400-WT
BBP31, BBP33	Fig. 18c	B30EP-174-593-GN	B-593	Green	1.000 (25.4)	4.000 (101.6)	1.250 (31.8)	4.250 (108.0)	1	300	B30-R4400-WT
BBP31, BBP33	Fig. 18c	B30EP-176-593-GN	B-593	Green	1.000 (25.4)	3.000 (76.2)	1.250 (31.8)	3.250 (82.6)	1	300	B30-R4400-WT
BBP31, BBP33	Fig. 18c	B30EP-177-593-GN	B-593	Green	2.500 (63.5)	3.000 (76.2)	2.750 (69.9)	3.250 (82.6)	1	125	B30-R4400-WT
BBP31, BBP33	Fig. 18c	B30EP-171-593-RD	B-593	Red	0.490 (12.5)	1.060 (26.9)	0.750 (19.1)	1.375 (34.9)	1	500	B30-R4400-WT
BBP31, BBP33	Fig. 18c	B30EP-172-593-RD	B-593	Red	0.590 (15.0)	1.770 (45.0)	0.850 (21.6)	2.500 (63.5)	1	450	B30-R4400-WT
BBP31, BBP33	Fig. 18c	B30EP-173-593-RD	B-593	Red	1.000 (25.4)	2.000 (50.8)	1.250 (31.8)	2.500 (63.5)	1	300	B30-R4400-WT
BBP31, BBP33	Fig. 18c	B30EP-174-593-RD	B-593	Red	1.000 (25.4)	4.000 (101.6)	1.250 (31.8)	4.250 (108.0)	1	300	B30-R4400-WT
BBP31, BBP33	Fig. 18c	B30EP-171-593-SL	B-593	Silver	0.490 (12.5)	1.060 (26.9)	0.750 (19.1)	1.375 (34.9)	1	500	B30-R6000
BBP31, BBP33	Fig. 18c	B30EP-172-593-SL	B-593	Silver	0.590 (15.0)	1.770 (45.0)	0.850 (21.6)	2.500 (63.5)	1	450	B30-R6000
BBP31, BBP33	Fig. 18c	B30EP-173-593-SL	B-593	Silver	1.000 (25.4)	2.000 (50.8)	1.250 (31.8)	2.500 (63.5)	1	300	B30-R6000
BBP31, BBP33	Fig. 18c	B30EP-174-593-SL	B-593	Silver	1.000 (25.4)	4.000 (101.6)	1.250 (31.8)	4.250 (108.0)	1	300	B30-R6000

View all BBP<sup>®</sup>33 and BBP<sup>®</sup>33 Print Ribbon parts on page 379.

# BBP<sup>®</sup>31 and BBP<sup>®</sup>33 Materials

BradyID.com/bbp31

## General ID Labels for Lean 5S, Bins and Production Areas (B-483, B-484, B-498, B-499, B-593, B-595)

- Various sizes in several durable material types
- Also ideal for marking backer board, DIN rail, relays, PLCs, switches, solenoids, drive motors and other components inside panels
- All recommended materials are flexible and have high-tack adhesives for adhesion to wide variety of surfaces and components

**B-483:** Service temp: -40°F to 248°F Agency approvals:   
**B-484:** Service temp: -40°F to 240°F Agency approvals:   
**B-498:** Service temp: -40°F to 175°F Agency approvals:   
**B-499:** Service temp: -40°F to 193°F Agency approvals:   
**B-593:** Service temp: -4°F to 212°F Agency approvals:   
**B-595:** Service temp: -40°F to 180°F, 8-10 years average outdoor durability Agency approvals:

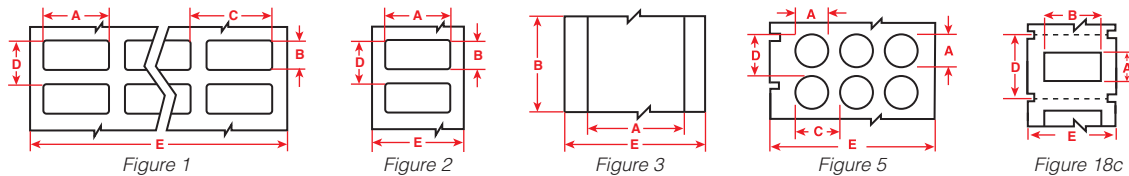

Fits Printer Model(s)	Diagram	Catalog #	B#	Color	Label Width A Inch (mm)	Label Height B Inch (mm)	Horiz. Repeat C Inch (mm)	Vert. Repeat D Inch (mm)	Web Width E Inch (mm)	Labels Per Row	Labels Per Roll	Rec. Ribbon
<b>Vinyl Cloth - Aggressive but repositionable adhesive (B-498):</b>												
BBP33 only	Fig. 1	B33-90-498	B-498	White	0.250 (6.4)	1.437 (36.5)	0.350 (8.9)	1.562 (39.7)	2.200 (55.9)	6	2500	B30-R6200
BBP33 only	Fig. 1	B33-68-498	B-498	White	0.500 (12.7)	0.750 (19.1)	0.600 (15.2)	0.875 (22.2)	2.500 (63.5)	4	5000	B30-R6200
BBP33 only	Fig. 1	B33-87-498	B-498	White	0.500 (12.7)	1.437 (36.5)	0.600 (15.2)	1.562 (39.7)	3.700 (94.0)	6	2500	B30-R6200
BBP33 only	Fig. 1	B33-1-498	B-498	White	0.750 (19.1)	0.250 (6.4)	0.800 (20.3)	0.350 (8.9)	3.350 (85.1)	4	5000	B30-R6200
BBP33 only	Fig. 1	B33-95-498	B-498	White	0.800 (20.3)	1.437 (36.5)	0.900 (22.9)	1.562 (39.7)	2.800 (71.1)	3	2300	B30-R6200
BBP33 only	Fig. 1	B33-5-498	B-498	White	1.000 (25.4)	0.500 (12.7)	1.075 (27.3)	0.600 (15.2)	3.350 (85.1)	3	5000	B30-R6200
BBP33 only	Fig. 1	B33-88-498	B-498	White	1.000 (25.4)	0.750 (19.1)	1.100 (27.9)	0.875 (22.2)	2.300 (58.4)	2	2500	B30-R6200
BBP33 only	Fig. 1	B33-89-498	B-498	White	1.000 (25.4)	1.437 (36.5)	1.100 (27.9)	1.562 (39.7)	3.400 (86.4)	3	2300	B30-R6200
<b>Nylon Cloth - Permanent adhesive (B-499):</b>												
BBP33 only	Fig. 5	B33-143-499	B-499	White	0.375 (9.5 dia)	-	0.475 (12.1)	0.500 (12.7)	2.000 (50.8)	4	1500	B30-R6000
BBP33 only	Fig. 1	B33-144-499	B-499	White	0.500 (12.7)	0.500 (12.7)	0.600 (15.2)	0.625 (15.9)	1.900 (48.3)	3	1500	B30-R6000
BBP33 only	Fig. 1	B33-68-499	B-499	White	0.500 (12.7)	0.750 (19.1)	0.600 (15.2)	0.875 (22.2)	2.500 (63.5)	4	1500	B30-R6000
BBP33 only	Fig. 1	B33-165-499	B-499	White	0.800 (20.3)	1.437 (36.5)	0.900 (22.9)	1.562 (39.7)	3.700 (94.0)	4	2500	B30-R6000
BBP33 only	Fig. 2	B33-136-499	B-499	White	1.500 (38.1)	0.750 (19.1)	-	0.875 (22.2)	1.770 (45.0)	1	1500	B30-R6000
BBP33 only	Fig. 2	B33-137-499	B-499	White	2.000 (50.8)	1.000 (25.4)	-	1.125 (28.6)	2.200 (55.9)	1	1100	B30-R6000
<b>Polyester - Ultra aggressive adhesive for highly textured and low surface energy surfaces (B-483):</b>												
BBP33 only	Fig. 1	B33-149-483	B-483	White	0.500 (12.7)	0.500 (12.7)	0.600 (15.2)	0.600 (15.2)	2.500 (63.5)	4	5000	B30-R6000
BBP33 only	Fig. 1	B33-5-483	B-483	White	1.000 (25.4)	0.500 (12.7)	1.075 (27.3)	0.600 (15.2)	3.350 (85.1)	3	5000	B30-R6000
BBP33 only	Fig. 2	B33-17-483	B-483	White	2.000 (50.8)	1.000 (25.4)	-	1.125 (28.6)	2.200 (55.9)	1	1500	B30-R6000
BBP33 only	Fig. 2	B33-7-483	B-483	White	2.750 (69.9)	1.250 (31.8)	-	1.375 (34.9)	2.950 (74.9)	1	1000	B30-R6000
BBP33 only	Fig. 2	B33-18-483	B-483	White	3.000 (76.2)	1.000 (25.4)	-	1.125 (28.6)	3.200 (81.3)	1	1500	B30-R6000
BBP33 only	Fig. 2	B33-19-483	B-483	White	3.000 (76.2)	2.000 (50.8)	-	2.125 (54.0)	3.200 (81.3)	1	500	B30-R6000
BBP33 only	Fig. 2	B33-55-483	B-483	White	4.000 (101.6)	2.000 (50.8)	-	2.125 (54.0)	4.200 (106.7)	1	750	B30-R6000
<b>Polyester - Ultra-aggressive adhesive and pliable for conforming to angular surfaces (B-484):</b>												
BBP33 only	Fig. 2	B33-125-484	B-484	White	0.900 (22.9)	0.500 (12.7)	-	0.600 (15.2)	1.100 (27.9)	1	1500	B30-R6000
BBP33 only	Fig. 1	B33-5-484	B-484	White	1.000 (25.4)	0.500 (12.7)	1.075 (27.3)	0.600 (15.2)	3.350 (85.1)	3	5000	B30-R6000
BBP33 only	Fig. 2	B33-136-484	B-484	White	1.500 (38.1)	0.750 (19.1)	-	0.875 (22.2)	1.700 (43.2)	1	1500	B30-R6000
BBP33 only	Fig. 2	B33-17-484	B-484	White	2.000 (50.8)	1.000 (25.4)	-	1.125 (28.6)	2.200 (55.9)	1	1500	B30-R6000
BBP33 only	Fig. 2	B33-18-484	B-484	White	3.000 (76.2)	1.000 (25.4)	-	1.125 (28.6)	3.200 (81.3)	1	1500	B30-R6000
BBP33 only	Fig. 2	B33-19-484	B-484	White	3.000 (76.2)	2.000 (50.8)	-	2.125 (54.0)	3.200 (81.3)	1	500	B30-R6000
<b>Raised Profile Labels - Engraved plate substitute labels (B-593*):</b>												
BBP31, BBP33	Fig. 18c	B30EP-171-593-WT	B-593	White	0.490 (12.5)	1.060 (26.9)	-	0.750 (19.1)	1.375 (34.9)	1	500	B30-R6000
BBP31, BBP33	Fig. 18c	B30EP-171-593-SL	B-593	Silver	0.490 (12.5)	1.060 (26.9)	-	0.750 (19.1)	1.375 (34.9)	1	500	B30-R6000
BBP31, BBP33	Fig. 18c	B30EP-171-593-BK	B-593	Black	0.490 (12.5)	1.060 (26.9)	-	0.750 (19.1)	1.375 (34.9)	1	500	B30-R4400-WT
<b>Continuous cut-to-length vinyl - Permanent adhesive, conformable; indoor/outdoor grade (B-595*):</b>												
BBP31, BBP33	Fig. 3	B30C-500-595-WT	B-595	White	0.500 (12.7)	100 ft. (30.5m)	-	-	0.700 (17.8)	1 roll (cont.)		B30-R10000
BBP31, BBP33	Fig. 3	B30C-1125-595-WT	B-595	White	1.125 (28.6)	100 ft. (30.5m)	-	-	1.375 (34.9)	1 roll (cont.)		B30-R10000
BBP31, BBP33	Fig. 3	B30C-500-595-YL	B-595	Yellow	0.500 (12.7)	100 ft. (30.5m)	-	-	0.700 (17.8)	1 roll (cont.)		B30-R10000
BBP31, BBP33	Fig. 3	B30C-1125-595-YL	B-595	Yellow	1.125 (28.6)	100 ft. (30.5m)	-	-	1.375 (34.9)	1 roll (cont.)		B30-R10000

\* 58 additional sizes and colors available for B-593 (page 365).  
 46 additional sizes and colors available for B-595 (page 358).

View all BBP<sup>®</sup>33 and BBP<sup>®</sup>33 Print Ribbon parts on page 379.



# BBP<sup>®</sup>31 and BBP<sup>®</sup>33 Materials

BradyID.com/bbp31

## Polyester General ID Labels (B-422, B-423, B-430, B-432, B483, B-484, B-489)

- For general purpose industrial ID applications, bin and shelf labeling in production areas, and PC board component ID

**B-423, B-483, B-489:** Service temp: -94°F to 248°F  
Agency approvals:

**B-430, B-432:** Service temp: -40°F to 212°F  
Agency approvals:

**B-484:** Service temp: -40°F to 240°F  
Agency approvals:

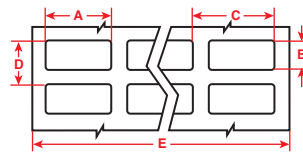

Figure 1

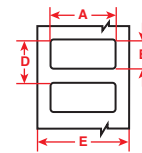

Figure 2



Benchmark Printers

Fits Printer Model(s)	Diagram	Catalog #	B#	Color	Label Width A Inch (mm)	Label Height B Inch (mm)	Horiz. Repeat C Inch (mm)	Vert. Repeat D Inch (mm)	Web Width E Inch (mm)	Labels Per Row	Labels Per Roll	Rec. Ribbon
<b>Standard adhesive (B-423 gloss white):</b>												
BBP33 only	Fig. 4	B33-11-423	B-423	Gloss White	0.250 (6.4)	0.250 (6.4)	0.250 (6.4)	0.375 (9.5)	3.200 (81.3)	12	15000	B30-R6000
BBP33 only	Fig. 1	B33-38-423	B-423	Gloss White	0.375 (9.5)	0.375 (9.5)	0.438 (11.1)	0.475 (12.1)	3.200 (81.3)	9	5000	B30-R6000
BBP33 only	Fig. 1	B33-149-423	B-423	Gloss White	0.500 (12.7)	0.500 (12.7)	0.600 (15.2)	0.600 (15.2)	2.500 (63.5)	4	5000	B30-R6000
BBP33 only	Fig. 1	B33-1-423	B-423	Gloss White	0.750 (19.1)	0.250 (6.4)	0.800 (20.3)	0.350 (8.9)	3.350 (85.1)	4	5000	B30-R6000
BBP33 only	Fig. 2	B33-46-423	B-423	Gloss White	0.750 (19.1)	0.250 (6.4)	-	0.350 (8.9)	0.950 (24.1)	1	5000	B30-R6000
BBP33 only	Fig. 2	B33-49-423	B-423	Gloss White	0.900 (22.9)	0.250 (6.4)	-	0.350 (8.9)	1.100 (27.9)	1	5000	B30-R6000
BBP33 only	Fig. 2	B33-103-423	B-423	Gloss White	1.000 (25.4)	0.250 (6.4)	-	0.350 (8.9)	1.200 (30.5)	1	5000	B30-R6000
BBP33 only	Fig. 1	B33-3-423	B-423	Gloss White	1.000 (25.4)	0.375 (9.5)	1.075 (27.3)	0.475 (12.1)	3.350 (85.1)	3	5000	B30-R6000
BBP33 only	Fig. 1	B33-5-423	B-423	Gloss White	1.000 (25.4)	0.500 (12.7)	1.075 (27.3)	0.600 (15.2)	3.350 (85.1)	3	5000	B30-R6000
BBP33 only	Fig. 2	B33-43-423	B-423	Gloss White	1.250 (31.8)	0.250 (6.4)	-	0.350 (8.9)	1.450 (36.8)	1	5000	B30-R6000
BBP33 only	Fig. 1	B33-29-423	B-423	Gloss White	1.250 (31.8)	0.375 (9.5)	1.300 (33.0)	0.475 (12.1)	2.750 (69.9)	2	5000	B30-R6000
BBP33 only	Fig. 2	B33-45-423	B-423	Gloss White	1.500 (38.1)	0.250 (6.4)	-	0.350 (8.9)	1.700 (43.2)	1	5000	B30-R6000
BBP33 only	Fig. 2	B33-72-423	B-423	Gloss White	1.750 (44.5)	0.250 (6.4)	-	0.350 (8.9)	1.950 (49.5)	1	5000	B30-R6000
BBP33 only	Fig. 2	B33-53-423	B-423	Gloss White	2.000 (50.8)	0.500 (12.7)	-	0.600 (15.2)	2.200 (55.9)	1	2500	B30-R6000
BBP33 only	Fig. 2	B33-17-423	B-423	Gloss White	2.000 (50.8)	1.000 (25.4)	-	1.125 (28.6)	2.200 (55.9)	1	1500	B30-R6000
BBP33 only	Fig. 2	B33-18-423	B-423	Gloss White	3.000 (76.2)	1.000 (25.4)	-	1.125 (28.6)	3.200 (81.3)	1	1500	B30-R6000
BBP33 only	Fig. 2	B33-19-423	B-423	Gloss White	3.000 (76.2)	2.000 (50.8)	-	2.125 (54.0)	3.200 (81.3)	1	500	B30-R6000
BBP33 only	Fig. 2	B33-55-423	B-423	Gloss White	4.000 (101.6)	2.000 (50.8)	-	2.125 (54.0)	4.200 (106.7)	1	750	B30-R6000
<b>Standard adhesive (B-430 clear):</b>												
BBP33 only	Fig. 1	B33-5-430	B-430	Clear	1.000 (25.4)	0.500 (12.7)	1.075 (27.3)	0.625 (15.9)	3.350 (85.1)	3	5000	B30-R6000
BBP33 only	Fig. 2	B33-17-430	B-430	Clear	2.000 (50.8)	1.000 (25.4)	-	1.125 (28.6)	2.200 (55.9)	1	1500	B30-R6000
BBP33 only	Fig. 2	B33-18-430	B-430	Clear	3.000 (76.2)	1.000 (25.4)	-	1.125 (28.6)	3.200 (81.3)	1	1500	B30-R6000
<b>Stronger adhesive for textured surfaces (B-422 gloss white):</b>												
BBP33 only	Fig. 1	B33-149-422	B-422	White	0.500 (12.7)	0.500 (12.7)	0.600 (15.2)	0.600 (15.2)	2.500 (63.5)	4	5000	B30-R6000
BBP33 only	Fig. 1	B33-5-422	B-422	White	1.000 (25.4)	0.500 (12.7)	1.075 (27.3)	0.600 (15.2)	3.350 (85.1)	3	5000	B30-R6000
BBP33 only	Fig. 1	B33-147-422	B-422	White	1.500 (38.1)	0.375 (9.5)	1.650 (41.9)	0.475 (12.1)	3.350 (85.1)	2	2500	B30-R6000
BBP33 only	Fig. 2	B33-102-422	B-422	White	1.500 (38.1)	0.375 (9.5)	-	0.500 (12.7)	1.700 (43.2)	1	2500	B30-R6000
BBP33 only	Fig. 2	B33-136-422	B-422	White	1.500 (38.1)	0.750 (19.1)	-	0.875 (22.2)	1.700 (43.2)	1	1500	B30-R6000
BBP33 only	Fig. 2	B33-17-422	B-422	White	2.000 (50.8)	1.000 (25.4)	-	1.125 (28.6)	2.200 (55.9)	1	1500	B30-R6000
BBP33 only	Fig. 2	B33-18-422	B-422	White	3.000 (76.2)	1.000 (25.4)	-	1.125 (28.6)	3.200 (81.3)	1	1500	B30-R6000
BBP33 only	Fig. 2	B33-19-422	B-422	White	3.000 (76.2)	2.000 (50.8)	-	2.125 (54.0)	3.200 (81.3)	1	500	B30-R6000
BBP33 only	Fig. 2	B33-76-422	B-422	White	4.000 (101.6)	3.000 (76.2)	-	3.125 (79.4)	4.200 (106.7)	1	500	B30-R6000
<b>Stronger adhesive for textured surfaces (B-432 clear):</b>												
BBP33 only	Fig. 1	B33-149-432	B-432	Clear	0.500 (12.7)	0.500 (12.7)	0.600 (15.2)	0.625 (15.9)	2.500 (63.5)	4	5000	B30-R6000
BBP33 only	Fig. 1	B33-5-432	B-432	Clear	1.000 (25.4)	0.500 (12.7)	1.075 (27.3)	0.600 (15.2)	3.350 (85.1)	3	5000	B30-R6000
BBP33 only	Fig. 2	B33-17-432	B-432	Clear	2.000 (50.8)	1.000 (25.4)	-	1.125 (28.6)	2.200 (55.9)	1	1500	B30-R6000
BBP33 only	Fig. 2	B33-18-432	B-432	Clear	3.000 (76.2)	1.000 (25.4)	-	1.125 (28.6)	3.200 (81.3)	1	1500	B30-R6000
BBP33 only	Fig. 2	B33-19-432	B-432	Clear	3.000 (76.2)	2.000 (50.8)	-	2.125 (54.0)	3.200 (81.3)	1	500	B30-R6000
<b>Ultra aggressive adhesive for highly textured surfaces (B-483 gloss white):</b>												
BBP33 only	Fig. 1	B33-149-483	B-483	Gloss White	0.500 (12.7)	0.500 (12.7)	0.600 (15.2)	0.600 (15.2)	2.500 (63.5)	4	5000	B30-R6000
BBP33 only	Fig. 1	B33-5-483	B-483	Gloss White	1.000 (25.4)	0.500 (12.7)	1.075 (27.3)	0.600 (15.2)	3.350 (85.1)	3	5000	B30-R6000
BBP33 only	Fig. 2	B33-17-483	B-483	Gloss White	2.000 (50.8)	1.000 (25.4)	-	1.125 (28.6)	2.200 (55.9)	1	1500	B30-R6000
BBP33 only	Fig. 2	B33-7-483	B-483	Gloss White	2.750 (69.9)	1.250 (31.8)	-	1.375 (34.9)	2.950 (74.9)	1	1000	B30-R6000
BBP33 only	Fig. 2	B33-18-483	B-483	Gloss White	3.000 (76.2)	1.000 (25.4)	-	1.125 (28.6)	3.200 (81.3)	1	1500	B30-R6000
BBP33 only	Fig. 2	B33-19-483	B-483	Gloss White	3.000 (76.2)	2.000 (50.8)	-	2.125 (54.0)	3.200 (81.3)	1	500	B30-R6000
BBP33 only	Fig. 2	B33-55-483	B-483	Gloss White	4.000 (101.6)	2.000 (50.8)	-	2.125 (54.0)	4.200 (106.7)	1	750	B30-R6000
<b>Ultra aggressive adhesive for highly textured surfaces (B-489 matte white):</b>												
BBP33 only	Fig. 1	B33-5-489	B-489	Matte White	1.000 (25.4)	0.500 (12.7)	1.075 (27.3)	0.600 (15.2)	3.350 (85.1)	3	5000	B30-R4300
BBP33 only	Fig. 2	B33-17-489	B-489	Matte White	2.000 (50.8)	1.000 (25.4)	-	1.125 (28.6)	2.200 (55.9)	1	1500	B30-R4300
BBP33 only	Fig. 2	B33-18-489	B-489	Matte White	3.000 (76.2)	1.000 (25.4)	-	1.125 (28.6)	3.200 (81.3)	1	1500	B30-R4300
BBP33 only	Fig. 2	B33-19-489	B-489	Matte White	3.000 (76.2)	2.000 (50.8)	-	2.125 (54.0)	3.200 (81.3)	1	500	B30-R4300
<b>Polyester - Ultra-aggressive adhesive and pliable for conforming to angular surfaces (B-484):</b>												
BBP33 only	Fig. 2	B33-125-484	B-484	White	0.900 (22.9)	0.500 (12.7)	-	0.600 (15.2)	1.100 (27.9)	1	1500	B30-R6000
BBP33 only	Fig. 1	B33-5-484	B-484	White	1.000 (25.4)	0.500 (12.7)	1.075 (27.3)	0.600 (15.2)	3.350 (85.1)	3	5000	B30-R6000
BBP33 only	Fig. 2	B33-136-484	B-484	White	1.500 (38.1)	0.750 (19.1)	-	0.875 (22.2)	1.700 (43.2)	1	1500	B30-R6000
BBP33 only	Fig. 2	B33-17-484	B-484	White	2.000 (50.8)	1.000 (25.4)	-	1.125 (28.6)	2.200 (55.9)	1	1500	B30-R6000
BBP33 only	Fig. 2	B33-18-484	B-484	White	3.000 (76.2)	1.000 (25.4)	-	1.125 (28.6)	3.200 (81.3)	1	1500	B30-R6000
BBP33 only	Fig. 2	B33-19-484	B-484	White	3.000 (76.2)	2.000 (50.8)	-	2.125 (54.0)	3.200 (81.3)	1	500	B30-R6000

View all BBP<sup>®</sup>33 and BBP<sup>®</sup>33 Print Ribbon parts on page 379.



## Metallized Polyester Labels (B-428, B-434, B-435, B-438, B-486, B-565)

- For product labeling, asset tracking and general industrial ID
- Silver metallic label withstands solvents and variable temperatures
- Ideal for serial number plates and rating plates with name-plate quality and metal-looking finish
- 3 adhesive strengths/gloss configurations to meet your needs

**B-428:** Service temp: -40°F to 293°F  
**B-434:** Service temp: -40°F to 194°F  
**B-435:** Service temp: -40°F to 194°F  
**B-438:** Service temp: -40°F to 104°F  
**B-486:** Service temp: -40°F to 248°F  
**B-565:** Service temp: -40°F to 240°F

Agency approvals:   
 Agency approvals:   
 Agency approvals:   
 Agency approvals:   
 Agency approvals:

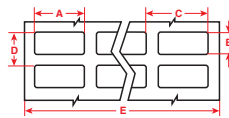

Figure 1

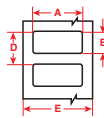

Figure 2

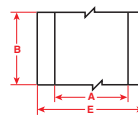

Figure 3

Fits Printer Model(s)	Diagram	Catalog #	B#	Color	Label Width A Inch (mm)	Label Height B Inch (mm)	Horiz. Repeat C Inch (mm)	Vert. Repeat D Inch (mm)	Web Width E Inch (mm)	Labels Per Row	Labels Per Roll	Rec. Ribbon
<b>Standard adhesive for smooth surfaces (B-428 matte):</b>												
BBP33 only	Fig. 1	B33-5-428	B-428	Matte Silver	1.000 (25.4)	0.500 (12.7)	1.075 (27.3)	0.600 (15.2)	3.350 (85.1)	3	5000	B30-R4300
BBP33 only	Fig. 2	B33-53-428	B-428	Matte Silver	2.000 (50.8)	0.500 (12.7)	-	0.600 (15.2)	2.200 (55.9)	1	2500	B30-R4300
BBP33 only	Fig. 2	B33-17-428	B-428	Matte Silver	2.000 (50.8)	1.000 (25.4)	-	1.125 (28.6)	2.200 (55.9)	1	1500	B30-R4300
BBP33 only	Fig. 2	B33-18-428	B-428	Matte Silver	3.000 (76.2)	1.000 (25.4)	-	1.125 (28.6)	3.200 (81.3)	1	1500	B30-R4300
BBP33 only	Fig. 2	B33-19-428	B-428	Matte Silver	3.000 (76.2)	2.000 (50.8)	-	2.125 (54.0)	3.200 (81.3)	1	500	B30-R4300
BBP33 only	Fig. 3	B33C-3000-428	B-428	Matte Silver	3.000 (76.2)	85 ft (25.9m)	-	-	3.400 (86.4)	-	1 roll (cont.)	B30-R4300
<b>Standard adhesive for smooth surfaces. Material compatible in BBP31 Printer (B-565 matte):</b>												
BBP31, BBP33	Fig. 3	B30C-1125-565-SL	B-565	Matte Silver	1.125 (28.6)	100 ft. (30.5m)	-	-	1.375 (34.9)	-	1 roll (cont.)	B30-R4300
BBP31, BBP33	Fig. 3	B30C-2250-565-SL	B-565	Matte Silver	2.250 (57.5)	100ft. (30.5m)	-	-	2.500 (63.5)	-	1 roll (cont.)	B30-R4300
BBP31, BBP33	Fig. 3	B30C-4000-565-SL	B-565	Matte Silver	4.000 (101.6)	100ft. (30.5m)	-	-	4.200 (106.7)	-	1 roll (cont.)	B30-R4300
<b>Standard adhesive for smooth surfaces (B-435 glossy):</b>												
BBP33 only	Fig. 2	B33-18-435	B-435	Gloss Silver	3.000 (76.2)	1.000 (25.4)	-	1.125 (28.6)	3.200 (81.3)	1	1500	B30-R6000
BBP33 only	Fig. 2	B33-19-435	B-435	Gloss Silver	3.000 (76.2)	2.000 (50.8)	-	2.125 (54.0)	3.200 (81.3)	1	500	B30-R6000
BBP33 only	Fig. 2	B33-55-435	B-435	Gloss Silver	4.000 (101.6)	2.000 (50.8)	-	2.125 (54.0)	4.200 (106.7)	1	750	B30-R6000
<b>Stronger adhesive for rougher surfaces (B-434 glossy):</b>												
BBP33 only	Fig. 1	B33-5-434	B-434	Gloss Silver	1.000 (25.4)	0.500 (12.7)	1.075 (27.3)	0.600 (15.2)	3.350 (85.1)	3	5000	B30-R6000
BBP33 only	Fig. 2	B33-136-434	B-434	Gloss Silver	1.500 (38.1)	0.750 (19.1)	-	0.875 (22.2)	1.700 (43.2)	1	1500	B30-R6000
BBP33 only	Fig. 2	B33-17-434	B-434	Gloss Silver	2.000 (50.8)	1.000 (25.4)	-	1.125 (28.6)	2.200 (55.9)	1	1500	B30-R6000
BBP33 only	Fig. 2	B33-18-434	B-434	Gloss Silver	3.000 (76.2)	1.000 (25.4)	-	1.125 (28.6)	3.200 (81.3)	1	1500	B30-R6000
BBP33 only	Fig. 2	B33-19-434	B-434	Gloss Silver	3.000 (76.2)	2.000 (50.8)	-	2.125 (54.0)	3.200 (81.3)	1	500	B30-R6000
BBP33 only	Fig. 2	B33-55-434	B-434	Gloss Silver	4.000 (101.6)	2.000 (50.8)	-	2.125 (54.0)	4.200 (106.7)	1	750	B30-R6000
<b>Ultra aggressive adhesive for highly textured, powder coated and low surface energy surfaces (B-486 matte):</b>												
BBP33 only	Fig. 2	B33-59-486	B-486	Matte Silver	1.000 (25.4)	0.500 (12.7)	-	0.600 (15.2)	1.200 (30.5)	1	2500	B30-R4300
BBP33 only	Fig. 1	B33-5-486	B-486	Matte Silver	1.000 (25.4)	0.500 (12.7)	1.075 (27.3)	0.600 (15.2)	3.350 (85.1)	3	5000	B30-R4300
BBP33 only	Fig. 2	B33-53-486	B-486	Matte Silver	2.000 (50.8)	0.500 (12.7)	-	0.600 (15.2)	2.200 (55.9)	1	2500	B30-R4300
BBP33 only	Fig. 2	B33-17-486	B-486	Matte Silver	2.000 (50.8)	1.000 (25.4)	-	1.125 (28.6)	2.200 (55.9)	1	1300	B30-R4300
BBP33 only	Fig. 2	B33-7-486	B-486	Matte Silver	2.750 (69.9)	1.250 (31.8)	-	1.375 (34.9)	2.950 (74.9)	1	1000	B30-R4300
BBP33 only	Fig. 2	B33-18-486	B-486	Matte Silver	3.000 (76.2)	1.000 (25.4)	-	1.125 (28.6)	3.200 (81.3)	1	1300	B30-R4300
BBP33 only	Fig. 2	B33-19-486	B-486	Matte Silver	3.000 (76.2)	2.000 (50.8)	-	2.125 (54.0)	3.200 (81.3)	1	500	B30-R4300
BBP33 only	Fig. 2	B33-76-486	B-486	Matte Silver	4.000 (101.6)	3.000 (76.2)	-	3.125 (79.4)	4.200 (106.7)	1	500	B30-R4300
BBP33 only	Fig. 2	B33-161-486	B-486	Matte Silver	4.000 (101.6)	4.000 (101.6)	-	4.125 (104.8)	4.200 (106.7)	1	250	B30-R4300
<b>Tamper-Evident - Leaves checkerboard footprint on surface and on label if removed to prevent re-use (B-438 matte):</b>												
BBP31, BBP33	Fig. 2	B30-17-438	B-438	Matte Silver	2.000 (50.8)	1.000 (25.4)	-	2.500 (63.5)	1.125 (28.6)	1	1225	B30-R4300
BBP31, BBP33	Fig. 2	B30-18-438	B-438	Matte Silver	3.000 (76.2)	1.000 (25.4)	-	3.250 (82.6)	1.250 (31.8)	1	1225	B30-R4300
BBP31, BBP33	Fig. 2	B30-222-438	B-438	Matte Silver	3.000 (76.2)	2.000 (50.8)	-	3.250 (82.6)	2.250 (57.2)	1	650	B30-R4300
BBP31, BBP33	Fig. 3	B30C-3000-438-SL	B-438	Matte Silver	3.000 (76.2)	100 ft. (30.5m)	-	-	3.250 (82.6)	-	1 roll (cont.)	B30-R4300

View all BBP<sup>®</sup>33 and BBP<sup>®</sup>33 Print Ribbon parts on page 379.



# BBP<sup>®</sup>33 Materials

BradyID.com/bbp31

## Standard Polyimide Labels (B-724, B-727)

- Top or bottom-side component ID or board ID labels that withstand the various processes, fluxes and cleaning solvents encountered in the manufacture of printed circuit boards

**B-727:** Service temp: -94°F to 212°F (short burst max temp: 80 sec at 572°F, 5 min at 500°F, 2 hrs at 338°F)  
Agency approvals: RoHS

**B-724:** Service temp: -94°F to 518°F (short burst max temp: 80 sec at 626°F, 5 min at 536°F)  
Agency approvals: RoHS

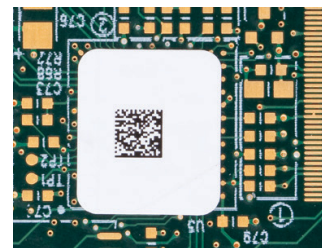
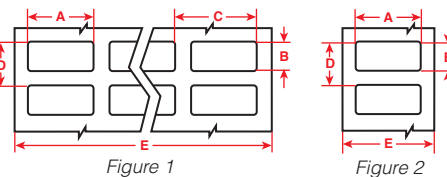

Benchmark Printers

Fits Printer Model(s)	Diagram	Catalog #	B#	Color	Label Width A Inch (mm)	Label Height B Inch (mm)	Horiz. Repeat C Inch (mm)	Vert. Repeat D Inch (mm)	Web Width E Inch (mm)	Labels Per Row	Labels Per Roll	Rec. Ribbon
<b>Standard temperature (B-727 gloss white):</b>												
BBP33 only	Fig. 1	B33-11-727	B-727	Gloss White	0.250 (6.35)	0.250 (6.4)	0.25 (6.4)	0.375 (9.5)	3.200 (81.3)	12	5000	B30-R6000
BBP33 only	Fig. 1	B33-38-727	B-727	Gloss White	0.375 (9.5)	0.375 (9.5)	0.438 (11.1)	0.475 (12.1)	3.200 (81.3)	9	5000	B30-R6000
BBP33 only	Fig. 1	B33-149-727	B-727	Gloss White	0.500 (12.7)	0.500 (12.7)	0.600 (15.2)	0.600 (15.2)	2.500 (63.5)	4	5000	B30-R6000
BBP33 only	Fig. 2	B33-46-727	B-727	Gloss White	0.750 (19.1)	0.250 (6.4)	-	0.350 (8.9)	0.950 (24.1)	1	5000	B30-R6000
BBP33 only	Fig. 1	B33-1-727	B-727	Gloss White	0.750 (19.1)	0.250 (6.4)	0.800 (20.3)	0.350 (8.9)	3.350 (85.1)	4	5000	B30-R6000
BBP33 only	Fig. 2	B33-49-727	B-727	Gloss White	0.900 (22.9)	0.250 (6.4)	-	0.350 (8.9)	1.100 (27.9)	1	5000	B30-R6000
BBP33 only	Fig. 1	B33-2-727	B-727	Gloss White	0.900 (22.9)	0.250 (6.4)	1.125 (28.6)	0.350 (8.9)	3.350 (85.1)	3	5000	B30-R6000
BBP33 only	Fig. 2	B33-103-727	B-727	Gloss White	1.000 (25.4)	0.250 (6.4)	-	0.350 (8.9)	1.200 (30.5)	1	5000	B30-R6000
BBP33 only	Fig. 2	B33-58-727	B-727	Gloss White	1.000 (25.4)	0.375 (9.5)	-	0.475 (12.1)	1.200 (30.5)	1	5000	B30-R6000
BBP33 only	Fig. 2	B33-59-727	B-727	Gloss White	1.000 (25.4)	0.500 (12.7)	-	0.600 (15.2)	1.200 (30.5)	1	2500	B30-R6000
BBP33 only	Fig. 2	B33-43-727	B-727	Gloss White	1.250 (31.8)	0.250 (6.4)	-	0.350 (8.9)	1.450 (36.8)	1	5000	B30-R6000
BBP33 only	Fig. 2	B33-44-727	B-727	Gloss White	1.375 (34.9)	0.250 (6.4)	-	0.350 (8.9)	1.600 (40.6)	1	5000	B30-R6000
BBP33 only	Fig. 2	B33-45-727	B-727	Gloss White	1.500 (38.1)	0.250 (6.4)	-	0.350 (8.9)	1.700 (43.2)	1	5000	B30-R6000
BBP33 only	Fig. 2	B33-72-727	B-727	Gloss White	1.750 (44.5)	0.250 (6.4)	-	0.350 (8.9)	1.950 (49.5)	1	5000	B30-R6000
<b>Extremely high temperature (B-724 matte amber):</b>												
BBP33 only	Fig. 1	B33-149-724	B-724	Matte Amber	0.500 (12.7)	0.500 (12.7)	0.600 (15.2)	0.600 (15.2)	2.500 (63.5)	4	5000	B30-R4300
BBP33 only	Fig. 2	B33-46-724	B-724	Matte Amber	0.750 (19.1)	0.250 (6.4)	-	0.350 (8.9)	0.950 (24.1)	1	5000	B30-R4300
BBP33 only	Fig. 1	B33-1-724	B-724	Matte Amber	0.750 (19.1)	0.250 (6.4)	0.800 (20.3)	0.350 (8.9)	3.350 (85.1)	4	5000	B30-R4300
BBP33 only	Fig. 1	B33-2-724	B-724	Matte Amber	0.900 (22.9)	0.250 (6.4)	1.125 (28.6)	0.350 (8.9)	3.350 (85.1)	3	5000	B30-R4300
BBP33 only	Fig. 2	B33-43-724	B-724	Matte Amber	1.250 (31.8)	0.250 (6.4)	-	0.350 (8.9)	1.450 (36.8)	1	5000	B30-R4300
BBP33 only	Fig. 1	B33-4-724	B-724	Matte Amber	1.500 (38.1)	0.250 (6.4)	-	0.350 (8.9)	3.350 (85.1)	2	5000	B30-R4300

## Static Dissipative Polyimide Labels (B-717, B-718, B-719)

- Circuit board and electronic component ID with static dissipative adhesive and release liner with surface resistivity values recommended for dissipative ESD packaging

- Complies with EIA-541 Packaging Material Standards for ESD Sensitive Items

- For top or bottom-side component or board identification

**All:** Service temp: -94°F to 212°F (short burst max temp: 80 sec at 572°F, 5 min at 500°F, 2 hrs at 338°F)  
Agency approvals: RoHS

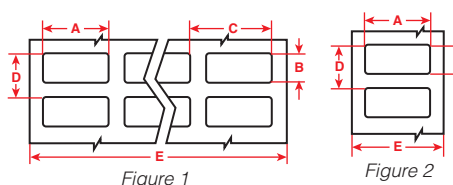



Fits Printer Model(s)	Diagram	Catalog #	B#	Color	Label Width A Inch (mm)	Label Height B Inch (mm)	Horiz. Repeat C Inch (mm)	Vert. Repeat D Inch (mm)	Web Width E Inch (mm)	Labels Per Row	Labels Per Roll	Rec. Ribbon
<b>Standard thickness (B-717 gloss white):</b>												
BBP33 only	Fig. 2	B33-46-717	B-717	Gloss White	0.750 (19.1)	0.250 (6.4)	-	0.350 (8.9)	0.950 (24.1)	1	5000	B30-R6000
BBP33 only	Fig. 2	B33-103-717	B-717	Gloss White	1.000 (25.4)	0.250 (6.4)	-	0.350 (8.9)	1.200 (30.5)	1	5000	B30-R6000
BBP33 only	Fig. 2	B33-43-717	B-717	Gloss White	1.250 (31.8)	0.250 (6.4)	-	0.350 (8.9)	1.450 (36.8)	1	5000	B30-R6000
BBP33 only	Fig. 2	B33-45-717	B-717	Gloss White	1.500 (38.1)	0.250 (6.4)	-	0.350 (8.9)	1.700 (43.2)	1	5000	B30-R6000
<b>Low profile label (B-718 gloss white):</b>												
BBP33 only	Fig. 4	B33-11-718	B-718	Gloss White	0.250 (6.4)	0.250 (6.4)	0.250 (6.4)	0.375 (9.5)	3.200 (81.3)	12	15000	B30-R6000
BBP33 only	Fig. 1	B33-38-718	B-718	Gloss White	0.375 (9.5)	0.375 (9.5)	0.438 (11.1)	0.475 (12.1)	3.200 (81.3)	9	5000	B30-R6000
BBP33 only	Fig. 1	B33-149-718	B-718	Gloss White	0.500 (12.7)	0.500 (12.7)	0.600 (15.2)	0.600 (15.2)	2.500 (63.5)	4	5000	B30-R6000
BBP33 only	Fig. 1	B33-1-718	B-718	Gloss White	0.750 (19.1)	0.250 (6.4)	0.800 (20.3)	0.350 (8.9)	3.350 (85.1)	4	5000	B30-R6000
BBP33 only	Fig. 2	B33-46-718	B-718	Gloss White	0.750 (19.1)	0.250 (6.4)	-	0.350 (8.9)	0.950 (24.1)	1	5000	B30-R6000
BBP33 only	Fig. 2	B33-49-718	B-718	Gloss White	0.900 (22.9)	0.250 (6.4)	-	0.350 (8.9)	1.100 (27.9)	1	5000	B30-R6000
BBP33 only	Fig. 2	B33-43-718	B-718	Gloss White	1.250 (31.8)	0.250 (6.4)	-	0.350 (8.9)	1.450 (36.8)	1	5000	B30-R6000
BBP33 only	Fig. 2	B33-45-718	B-718	Gloss White	1.500 (38.1)	0.250 (6.4)	-	0.350 (8.9)	1.700 (43.2)	1	5000	B30-R6000
BBP33 only	Fig. 2	B33-72-718	B-718	Gloss White	1.750 (44.5)	0.250 (6.4)	-	0.350 (8.9)	1.950 (49.5)	1	5000	B30-R6000
<b>Low profile label - Matte white to prevent sticking of solder balls (B-719 matte white):</b>												
BBP33 only	Fig. 1	B33-38-719	B-719	Matte White	0.375 (9.5)	0.375 (9.5)	0.438 (11.1)	0.475 (12.1)	3.200 (81.3)	9	5000	B30-R6000
BBP33 only	Fig. 2	B33-46-719	B-719	Matte White	0.750 (19.1)	0.250 (6.4)	-	0.350 (8.9)	0.950 (24.1)	1	5000	B30-R6000
BBP33 only	Fig. 1	B33-2-719	B-719	Matte White	0.900 (22.9)	0.250 (6.4)	1.125 (28.6)	0.350 (8.9)	3.350 (85.1)	3	5000	B30-R6000
BBP33 only	Fig. 2	B33-42-719	B-719	Matte White	1.000 (25.4)	0.188 (4.8)	-	0.288 (7.3)	1.200 (30.5)	1	5000	B30-R6000
BBP33 only	Fig. 2	B33-43-719	B-719	Matte White	1.250 (31.8)	0.250 (6.4)	-	0.350 (8.9)	1.450 (36.8)	1	5000	B30-R6000

View all BBP<sup>®</sup>33 and BBP<sup>®</sup>33 Print Ribbon parts on page 379.

## Vinyl Cloth Adhesive Wire & Cable Labels (B-498)

- A vinyl cloth label for marking wires, cables and inside-panel components
- Repositionable! A highly unique adhesive and cloth construction gives excellent holding power and still allows for clean removal and reapplication
- Ideal choice for marking both ends of a wire that you may need to cut shorter before final termination

Service temp: -40°F to 175°F  
Agency Approvals:   

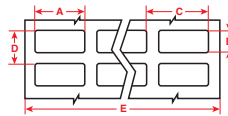
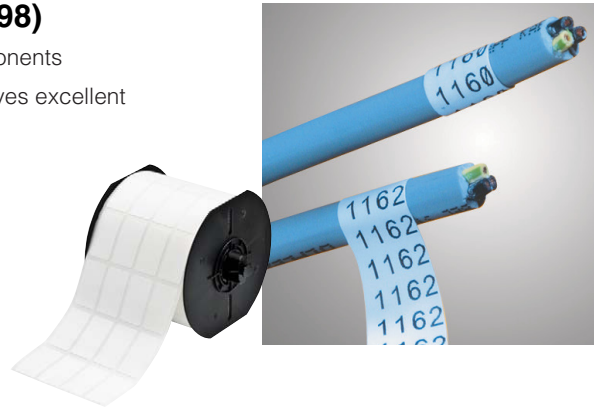



Figure 1



Fits Printer Model(s)	Diagram	Catalog #	B#	Color	Label Width A Inch (mm)	Label Height B Inch (mm)	Horiz. Repeat C Inch (mm)	Vert. Repeat D Inch (mm)	Web Width E Inch (mm)	Labels Per Row	Labels Per Roll	Rec. Ribbon
BBP33 only	Fig. 1	B33-90-498	B-498	White	0.250 (6.4)	1.437 (36.5)	0.350 (8.9)	1.562 (39.7)	2.200 (55.9)	6	2500	B30-R6200
BBP33 only	Fig. 1	B33-68-498	B-498	White	0.500 (12.7)	0.750 (19.1)	0.600 (15.2)	0.875 (22.2)	2.500 (63.5)	4	5000	B30-R6200
BBP33 only	Fig. 1	B33-87-498	B-498	White	0.500 (12.7)	1.437 (36.5)	0.600 (15.2)	1.562 (39.7)	3.700 (94)	6	2500	B30-R6200
BBP33 only	Fig. 1	B33-1-498	B-498	White	0.750 (19.1)	0.250 (6.4)	0.800 (20.3)	0.350 (8.9)	3.350 (85.1)	4	5000	B30-R6200
BBP33 only	Fig. 1	B33-91-498	B-498	White	0.750 (19.1)	0.937 (23.8)	0.850 (21.6)	1.062 (27.0)	3.500 (88.9)	4	2500	B30-R6200
BBP33 only	Fig. 1	B33-165-498	B-498	White	0.800 (20.3)	1.437 (36.5)	0.900 (22.9)	1.562 (39.7)	3.700 (94.0)	4	2500	B30-R6200
BBP33 only	Fig. 1	B33-95-498	B-498	White	0.800 (20.3)	1.437 (36.5)	0.900 (22.9)	1.562 (39.7)	2.800 (71.1)	3	2300	B30-R6200
BBP33 only	Fig. 1	B33-5-498	B-498	White	1.000 (25.4)	0.500 (12.7)	1.075 (27.3)	0.600 (15.2)	3.350 (85.1)	3	5000	B30-R6200
BBP33 only	Fig. 1	B33-88-498	B-498	White	1.000 (25.4)	0.750 (19.1)	1.100 (27.9)	0.875 (22.2)	2.300 (58.4)	2	2500	B30-R6200
BBP33 only	Fig. 1	B33-89-498	B-498	White	1.000 (25.4)	1.437 (36.5)	1.100 (27.9)	1.562 (39.7)	3.400 (86.4)	3	2300	B30-R6200

## Terminal Block Adhesive Strips (B-498)

- Specially designed narrow-width continuous label for alignment on terminal blocks and patch panels
- Highly unique adhesive and vinyl cloth construction gives excellent holding power and still allows for clean removal and reapplication

Service temp: -40°F to 175°F  
Agency Approvals:   

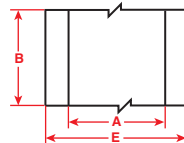

Figure 3



Fits Printer Model(s)	Diagram	Catalog #	B#	Color	Label Width A Inch (mm)	Roll Length B Feet (m)	Web Width E Inch (mm)	Labels Per Roll	Rec. Ribbon
BBP33 only	Fig. 3	B33C-240-498	B-498	White	0.240 (6.1)	85 ft. (25.9m)	1.000 (25.4)	1 roll (cont.)	B30-R6200
BBP33 only	Fig. 3	B33C-312-498	B-498	White	0.312 (7.9)	85 ft. (25.9m)	1.000 (25.4)	1 roll (cont.)	B30-R6200
BBP33 only	Fig. 3	B33C-375-498	B-498	White	0.375 (9.5)	85 ft. (25.9m)	1.000 (25.4)	1 roll (cont.)	B30-R6200



# BBP<sup>®</sup>33 Materials

BradyID.com/bbp31

## Self-Laminating Wire & Cable Labels (B-427)

- Brady's most popular wire marker!
- Features white printable area with clear "tail" that wraps around marker to protect text
- Superior resistance to abrasion, handling, solvents, water, oil and dirt
- Vinyl with permanent acrylic adhesive designed specifically for tightly curved surfaces

Service temp: -40°F to 158°F

Agency Approvals:

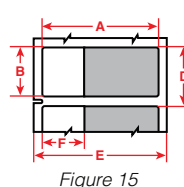
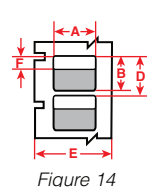
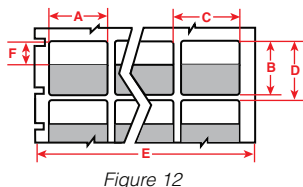
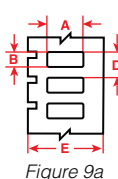

Fits Printer Model(s)	Diagram	Catalog #	B#	Color	Label Width A Inch (mm)	Label Height B Inch (mm)	Horiz. Repeat C Inch (mm)	Vert. Repeat D Inch (mm)	Web Width E Inch (mm)	Print Area Height F Inch (mm)	Labels Per Row	Labels Per Roll	Rec. Ribbon
BBP33 only	Fig. 12	B33-80-427	B-427	White	0.500 (12.7)	0.750 (19.1)	0.600 (15.2)	0.950 (24.1)	2.500 (63.5)	0.375 (9.5)	4	2500	B30-R4300
BBP33 only	Fig. 12	B33-113-427	B-427	White	0.500 (12.7)	1.000 (25.4)	0.600 (15.2)	0.950 (24.1)	2.500 (63.5)	0.375 (9.5)	4	2500	B30-R4300
BBP33 only	Fig. 12	B33-8-427	B-427	White	0.500 (12.7)	1.437 (36.5)	0.662 (16.8)	1.625 (41.3)	3.350 (85.1)	0.500 (12.7)	5	5000	B30-R4300
BBP33 only	Fig. 12	B33-56-427	B-427	White	0.750 (19.1)	0.937 (23.8)	0.800 (20.3)	1.125 (28.6)	3.350 (85.1)	0.375 (9.5)	4	5000	B30-R4300
BBP33 only	Fig. 12	B33-73-427	B-427	White	0.750 (19.1)	1.750 (44.6)	0.800 (20.3)	1.875 (47.6)	3.350 (85.1)	0.500 (12.7)	4	3500	B30-R4300
BBP33 only	Fig. 12	B33-74-427	B-427	White	0.800 (20.3)	1.437 (36.5)	0.800 (20.3)	1.625 (41.3)	3.400 (86.4)	0.500 (12.7)	4	4000	B30-R4300
BBP33 only	Fig. 12	B33-115-427	B-427	White	1.000 (25.4)	0.750 (19.1)	1.100 (27.9)	0.875 (22.2)	2.300 (58.4)	0.375 (9.5)	2	2500	B30-R4300
BBP33 only	Fig. 12	B33-116-427	B-427	White	1.000 (25.4)	1.000 (25.4)	1.100 (27.9)	1.125 (28.6)	2.300 (58.4)	0.375 (9.5)	2	2500	B30-R4300
BBP33 only	Fig. 12	B33-9-427	B-427	White	1.000 (25.4)	1.437 (36.5)	1.075 (27.3)	1.625 (41.3)	3.350 (85.1)	0.500 (12.7)	3	2500	B30-R4300
BBP33 only	Fig. 12	B33-75-427	B-427	White	1.000 (25.4)	2.250 (57.2)	1.100 (27.9)	1.875 (47.6)	2.300 (58.4)	0.750 (19.1)	2	1400	B30-R4300
BBP33 only	Fig. 15	B33-131-427	B-427	White	1.000 (25.4)	2.625 (66.7)	-	1.125 (28.6)	2.825 (71.8)	1.000 (25.4)	1	1500	B30-R4300
BBP33 only	Fig. 12	B33-10-427	B-427	White	1.000 (25.4)	3.750 (95.3)	1.075 (27.3)	4.000 (101.6)	3.350 (85.1)	1.000 (25.4)	3	1200	B30-R4300
BBP33 only	Fig. 12	B33-81-427	B-427	White	1.000 (25.4)	6.000 (152.4)	1.100 (27.9)	6.187 (157.1)	2.300 (58.4)	1.500 (38.1)	2	500	B30-R4300
BBP33 only	Fig. 9a	B33-135-427AW	B-427	White	1.500 (38.1)	0.750 (19.1)	-	0.875 (22.2)	1.700 (43.2)	-	1	1500	B30-R4300
BBP33 only	Fig. 14	B33-118-427	B-427	White	1.500 (38.1)	1.000 (25.4)	-	1.125 (28.6)	1.700 (43.2)	0.375 (9.5)	1	1250	B30-R4300
BBP33 only	Fig. 14	B33-119-427	B-427	White	1.500 (38.1)	1.500 (38.1)	-	1.750 (44.5)	1.700 (43.2)	0.500 (12.7)	1	1000	B30-R4300
BBP33 only	Fig. 14	B33-272-427	B-427	White	1.500 (38.1)	2.250 (57.2)	-	2.500 (63.5)	1.700 (43.2)	0.750 (19.1)	1	700	B30-R4300
BBP33 only	Fig. 14	B33-120-427	B-427	White	1.750 (44.5)	1.000 (25.4)	-	1.125 (28.6)	1.950 (49.5)	0.375 (9.5)	1	1250	B30-R4300
BBP33 only	Fig. 14	B33-121-427	B-427	White	1.750 (44.5)	1.500 (38.1)	-	1.750 (44.5)	1.950 (49.5)	0.500 (12.7)	1	1000	B30-R4300
BBP33 only	Fig. 14	B33-273-427	B-427	White	1.750 (44.5)	2.250 (57.2)	-	2.500 (63.5)	1.950 (49.5)	0.750 (19.1)	1	500	B30-R4300
BBP33 only	Fig. 9a	B33-137-427AW	B-427	White	2.000 (50.8)	1.000 (25.4)	-	1.125 (28.6)	2.200 (55.9)	-	1	1500	B30-R4300
BBP33 only	Fig. 14	B33-27-427	B-427	White	2.000 (50.8)	3.750 (95.3)	-	4.000 (101.6)	2.200 (55.9)	1.000 (25.4)	1	400	B30-R4300
BBP33 only	Fig. 14	B33-26-427	B-427	White	2.500 (63.5)	2.250 (57.2)	-	2.438 (61.9)	2.700 (68.8)	0.750 (19.1)	1	500	B30-R4300
BBP33 only	Fig. 14	B33-82-427	B-427	White	2.000 (50.8)	6.000 (152.4)	-	6.187 (157.1)	2.200 (55.9)	1.500 (38.1)	1	200	B30-R4300

## Patch Panel Adhesive Strips (B-422)

- Continuous supply in 3 widths to make labeling patch panels and other datacomm components quick and easy
- Aggressive adhesive suitable for rough, highly textured and powder-coated surfaces as well as smooth surfaces

Service temp: -40°F to 212°F

Agency Approvals:

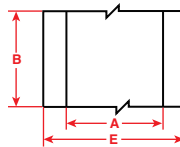

Fits Printer Model(s)	Diagram	Catalog #	B#	Color	Label Width A Inch (mm)	Roll Length B Feet (m)	Web Width E Inch (mm)	Labels Per Roll	Rec. Ribbon
BBP33 only	Fig. 3	B33C-240-422	B-422	White	0.240 (6.1)	85ft (25.9m)	1.000 (25.4)	1 roll (cont.)	B30-R6000
BBP33 only	Fig. 3	B33C-312-422	B-422	White	0.312 (7.9)	85ft (25.9m)	1.000 (25.4)	1 roll (cont.)	B30-R6000
BBP33 only	Fig. 3	B33C-375-422	B-422	White	0.375 (9.5)	85ft (25.9m)	1.000 (25.4)	1 roll (cont.)	B30-R6000

View all BBP<sup>®</sup>33 and BBP<sup>®</sup>33 Print Ribbon parts on page 379.

## Tedlar<sup>®</sup> Adhesive Wire & Cable Labels (B-437)

- Topcoated Polyvinylflouride label for wire & cable marking where high temperature and self-extinguishing features are required
- Heavy duty performance with excellent resistance to water, oil and other fluids
- Meets MIL-M-87958 Standard

Service temp: -94°F to 275°F  
Agency Approvals: **RoHS**

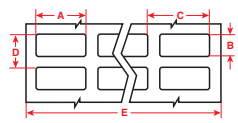

Figure 1

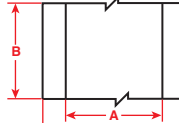

Figure 3

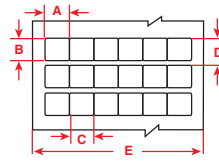

Figure 4



Fits Printer Model(s)	Diagram	Catalog #	B#	Color	Label Width A Inch (mm)	Label Height B Inch (mm)	Horiz. Repeat C Inch (mm)	Vert. Repeat D Inch (mm)	Web Width E Inch (mm)	Labels Per Row	Labels Per Roll	Rec. Ribbon
BBP33 only	Fig. 4	B33-11-437	B-437	White	0.250 (6.4)	0.250 (6.4)	0.250 (6.4)	0.375 (9.5)	3.200 (81.3)	12	15000	B30-R4300
BBP33 only	Fig. 1	B33-1-437	B-437	White	0.750 (19.1)	0.250 (6.4)	0.800 (20.3)	0.350 (8.9)	3.350 (85.1)	4	5000	B30-R4300
BBP33 only	Fig. 1	B33-2-437	B-437	White	0.900 (22.9)	0.250 (6.4)	1.125 (28.6)	0.350 (8.9)	3.350 (85.1)	3	5000	B30-R4300
BBP33 only	Fig. 1	B33-5-437	B-437	White	1.000 (25.4)	0.500 (12.7)	1.075 (27.3)	0.600 (15.2)	3.350 (85.1)	3	5000	B30-R4300
BBP33 only	Fig. 1	B33-29-437	B-437	White	1.250 (31.8)	0.375 (9.5)	1.300 (33.0)	0.475 (12.1)	2.750 (69.9)	2	5000	B30-R4300
BBP33 only	Fig. 1	B33-5-437YL	B-437	Yellow	1.000 (25.4)	0.500 (12.7)	1.075 (27.3)	0.600 (15.2)	3.350 (85.1)	3	5000	B30-R4300
BBP33 only	Fig. 1	B33-29-437YL	B-437	Yellow	1.250 (31.8)	0.375 (9.5)	1.300 (33.0)	0.475 (12.1)	2.750 (69.9)	2	5000	B30-R4300
<b>Continuous Rolls</b>												
BBP33 only	Fig. 3	B33C-1000-437	B-437	White	1.000 (25.4)	85ft. (25.9m)	-	-	1.200 (30.5)	1 roll (cont.)		B30-R4300
BBP33 only	Fig. 3	B33C-1500-437	B-437	White	1.500 (38.1)	85ft. (25.9m)	-	-	1.900 (48.3)	1 roll (cont.)		B30-R4300
BBP33 only	Fig. 3	B33C-2000-437	B-437	White	2.000 (50.8)	85ft. (25.9m)	-	-	2.200 (55.9)	1 roll (cont.)		B30-R4300
BBP33 only	Fig. 3	B33C-3000-437	B-437	White	3.000 (76.2)	85ft. (25.9m)	-	-	3.400 (86.4)	1 roll (cont.)		B30-R4300
BBP33 only	Fig. 3	B33C-1000-437YL	B-437	Yellow	1.000 (25.4)	85ft. (25.9m)	-	-	1.200 (30.5)	1 roll (cont.)		B30-R4300
BBP33 only	Fig. 3	B33C-1500-437YL	B-437	Yellow	1.500 (38.1)	85ft. (25.9m)	-	-	1.900 (48.3)	1 roll (cont.)		B30-R4300
BBP33 only	Fig. 3	B33C-2000-437YL	B-437	Yellow	2.000 (50.8)	85ft. (25.9m)	-	-	2.200 (55.9)	1 roll (cont.)		B30-R4300
BBP33 only	Fig. 3	B33C-3000-437YL	B-437	Yellow	3.000 (76.2)	85ft. (25.9m)	-	-	3.400 (86.4)	1 roll (cont.)		B30-R4300

## Polyimide High Temp Adhesive Wire & Cable Labels (B-472)

- Topcoated Polyimide label for wire & cable marking where high temperature and self-extinguishing features are required
- Heavy duty performance with excellent resistance to water, oil and other fluids

Service temp: -94°F to 320°F  
Agency Approvals: **RoHS**

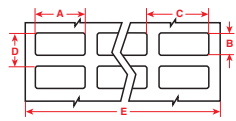

Figure 1

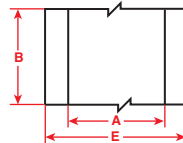

Figure 3

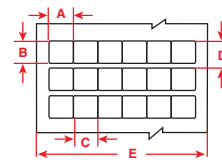

Figure 4



Fits Printer Model(s)	Diagram	Catalog #	B#	Color	Label Width A Inch (mm)	Label Height B Inch (mm)	Horiz. Repeat C Inch (mm)	Vert. Repeat D Inch (mm)	Web Width E Inch (mm)	Labels Per Row	Labels Per Roll	Rec. Ribbon
BBP33 only	Fig. 4	B33-11-472	B-472	White	0.250 (6.4)	0.250 (6.4)	0.250 (6.4)	0.375 (9.5)	3.200 (81.3)	12	15000	B30-R4300
BBP33 only	Fig. 1	B33-1-472	B-472	White	0.750 (19.1)	0.250 (6.4)	0.800 (20.3)	0.350 (8.9)	3.350 (85.1)	4	5000	B30-R4300
BBP33 only	Fig. 1	B33-2-472	B-472	White	0.900 (22.9)	0.250 (6.4)	1.125 (28.6)	0.350 (8.9)	3.350 (85.1)	3	5000	B30-R4300
BBP33 only	Fig. 1	B33-5-472	B-472	White	1.000 (25.4)	0.500 (12.7)	1.075 (27.3)	0.600 (15.2)	3.350 (85.1)	3	5000	B30-R4300
BBP33 only	Fig. 1	B33-29-472	B-472	White	1.250 (31.8)	0.375 (9.5)	1.300 (33.0)	0.475 (12.1)	2.750 (69.9)	2	5000	B30-R4300
BBP33 only	Fig. 1	B33-5-472YL	B-472	Yellow	1.000 (25.4)	0.500 (12.7)	1.075 (27.3)	0.600 (15.2)	3.350 (85.1)	3	5000	B30-R4300
BBP33 only	Fig. 1	B33-29-472YL	B-472	Yellow	1.250 (31.8)	0.375 (9.5)	1.300 (33.0)	0.475 (12.1)	2.750 (69.9)	2	5000	B30-R4300
<b>Continuous Rolls</b>												
BBP33 only	Fig. 3	B33C-1000-472	B-472	White	1.000 (25.4)	85ft. (25.9m)	-	-	1.200 (30.5)	1 roll (cont.)		B30-R4300
BBP33 only	Fig. 3	B33C-1500-472	B-472	White	1.500 (38.1)	85ft. (25.9m)	-	-	1.900 (48.3)	1 roll (cont.)		B30-R4300
BBP33 only	Fig. 3	B33C-2000-472	B-472	White	2.000 (50.8)	85ft. (25.9m)	-	-	2.200 (55.9)	1 roll (cont.)		B30-R4300
BBP33 only	Fig. 3	B33C-3000-472	B-472	White	3.000 (76.2)	85ft. (25.9m)	-	-	3.400 (86.4)	1 roll (cont.)		B30-R4300
BBP33 only	Fig. 3	B33C-1000-472YL	B-472	Yellow	1.000 (25.4)	85ft. (25.9m)	-	-	1.200 (30.5)	1 roll (cont.)		B30-R4300
BBP33 only	Fig. 3	B33C-1500-472YL	B-472	Yellow	1.500 (38.1)	85ft. (25.9m)	-	-	1.900 (48.3)	1 roll (cont.)		B30-R4300
BBP33 only	Fig. 3	B33C-2000-472YL	B-472	Yellow	2.000 (50.8)	85ft. (25.9m)	-	-	2.200 (55.9)	1 roll (cont.)		B30-R4300
BBP33 only	Fig. 3	B33C-3000-472YL	B-472	Yellow	3.000 (76.2)	85ft. (25.9m)	-	-	3.400 (86.4)	1 roll (cont.)		B30-R4300

View all BBP<sup>®</sup>33 and BBP<sup>®</sup>33 Print Ribbon parts on page 379.



# BBP<sup>®</sup>33 Materials

BradyID.com/bbp31

## PermaSleeve<sup>®</sup> PS Polyolefin Wire Marking Sleeves (B-342)

Standard Military/Industrial Grade. 3:1 Shrink ratio.

- A 3:1 heat shrinkable wire marker sleeve that fits snugly around wires
- Can be used for identification or wire protection
- Fade-resistant and flame-retardant
- Meets the following insulating and physical property specifications:
  - SAE-AMS-DTL-23053/5C (class 1)
  - SAE-AS-81531
  - MIL-STD-202
  - Tested per ASTM E162, ASTM E662



Service temp: -40°F to 267°F  
 (short burst max temp: 5 min at 500°F, 24 hrs at 350°F)  
 Agency Approvals:

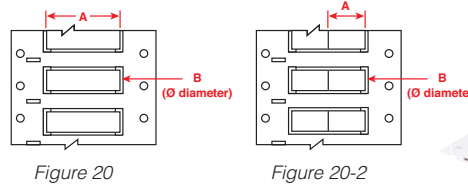

Fits Printer Model	Diagram	Catalog #	Material	Color	For Wire Gauge (approx.)	For Wire Diameters Inch (mm) Min. Max.	Supplied Diameter B Inch (mm)	Recovered Diameter Inch (mm)	Recovered Wall Thickness Inch (mm)	Sleeves Per Row	Per Roll	Rec. Ribbon
<b>3:1 Shrink ratio single-side printable, 2" sleeve width (dimension A):</b>												
BBP33	Fig. 20	B33-94-2-342	B-342	White	28 to 20	0.023 (0.6) - 0.080 (2.0)	0.094 (2.4)	0.024 (0.6)	.024 (0.6) +/- .003 (0.07)	1	1000	B30-R4300
BBP33	Fig. 20	B33-125-2-342	B-342	White	22 to 16	0.046 (1.2) - 1.110 (2.8)	0.125 (3.2)	0.047 (1.2)	.020 (0.5) +/- .003 (0.07)	1	1000	B30-R4300
BBP33	Fig. 20	B33-187-2-342	B-342	White	20 to 10	0.062 (1.6) - 0.150 (3.8)	0.187 (4.7)	0.062 (1.6)	.020 (0.5) +/- .003 (0.07)	1	750	B30-R4300
BBP33	Fig. 20	B33-250-2-342	B-342	White	16 to 8	0.094 (2.4) - 0.215 (5.5)	0.250 (6.4)	0.093 (2.4)	.025 (0.6) +/- .003 (0.07)	1	500	B30-R4300
BBP33	Fig. 20	B33-375-2-342	B-342	White	12 to 4	0.125 (3.2) - 0.320 (8.1)	0.375 (9.5)	0.125 (3.1)	.025 (0.6) +/- .003 (0.07)	1	500	B30-R4300
BBP33	Fig. 20	B33-500-2-342	B-342	White	8 to 1	0.187 (4.8) - 0.450 (11.4)	0.500 (12.7)	0.187 (4.7)	.025 (0.6) +/- .003 (0.07)	1	350	B30-R4300
BBP33	Fig. 20	B33-750-2-342	B-342	White	6 to 4/0	0.250 (6.4) - 0.700 (17.8)	0.750 (19.0)	0.250 (6.4)	.025 (0.6) +/- .003 (0.07)	1	250	B30-R4300
BBP33	Fig. 20	B33-1000-2-342	B-342	White	2 to 0.950 dia	0.333 (8.5) - 0.950 (24.1)	1.000 (25.4)	0.375 (9.5)	.036 (0.9) +/- .003 (0.07)	1	250	B30-R4300
BBP33	Fig. 20	B33-1500-2-342	B-342	White	n/a	0.500 (12.7) - 1.400 (35.6)	1.500 (38.1)	0.500 (12.7)	.035 (0.9) +/- .003 (0.07)	1	150	B30-R4300
BBP33	Fig. 20	B33-94-2-342YL	B-342	Yellow	28 to 20	0.023 (0.6) - 0.080 (2.0)	0.094 (2.4)	0.024 (0.6)	.024 (0.6) +/- .003 (0.07)	1	1000	B30-R4300
BBP33	Fig. 20	B33-125-2-342YL	B-342	Yellow	22 to 16	0.046 (1.2) - 1.110 (2.8)	0.125 (3.2)	0.047 (1.2)	.020 (0.5) +/- .003 (0.07)	1	1000	B30-R4300
BBP33	Fig. 20	B33-187-2-342YL	B-342	Yellow	20 to 10	0.062 (1.6) - 0.150 (3.8)	0.187 (4.7)	0.062 (1.6)	.020 (0.5) +/- .003 (0.07)	1	1000	B30-R4300
BBP33	Fig. 20	B33-250-2-342YL	B-342	Yellow	16 to 8	0.094 (2.4) - 0.215 (5.5)	0.250 (6.4)	0.093 (2.4)	.025 (0.6) +/- .003 (0.07)	1	500	B30-R4300
BBP33	Fig. 20	B33-375-2-342YL	B-342	Yellow	12 to 4	0.125 (3.2) - 0.320 (8.1)	0.375 (9.5)	0.125 (3.1)	.025 (0.6) +/- .003 (0.07)	1	250	B30-R4300
BBP33	Fig. 20	B33-500-2-342YL	B-342	Yellow	8 to 1	0.187 (4.8) - 0.450 (11.4)	0.500 (12.7)	0.187 (4.7)	.025 (0.6) +/- .003 (0.07)	1	500	B30-R4300
BBP33	Fig. 20	B33-750-2-342YL	B-342	Yellow	6 to 4/0	0.250 (6.4) - 0.700 (17.8)	0.750 (19.0)	0.250 (6.4)	.025 (0.6) +/- .003 (0.07)	1	350	B30-R4300
BBP33	Fig. 20	B33-1000-2-342YL	B-342	Yellow	2 to 0.950 dia	0.333 (8.5) - 0.950 (24.1)	1.000 (25.4)	0.375 (9.5)	.036 (0.9) +/- .003 (0.07)	1	250	B30-R4300
BBP33	Fig. 20	B33-1500-2-342YL	B-342	Yellow	n/a	0.500 (12.7) - 1.400 (35.6)	1.500 (38.1)	0.500 (12.7)	.035 (0.9) +/- .003 (0.07)	1	150	B30-R4300
BBP33	Fig. 20	B33-1500-2-342BK	B-342	Black	n/a	0.500 (12.7) - 1.400 (35.6)	1.500 (38.1)	0.500 (12.7)	.035 (0.9) +/- .003 (0.07)	1	150	B30-R4500-SV
<b>3:1 Shrink ratio single-side printable, 1" sleeve width in "2-up pre-cut" configuration (dimension A):</b>												
BBP33	Fig. 20-2	B33-94-2-342-2	B-342	White	28 to 20	0.023 (0.6) - 0.080 (2.0)	0.094 (2.4)	0.024 (0.6)	.024 (0.6) +/- .003 (0.07)	2	2000	B30-R4300
BBP33	Fig. 20-2	B33-125-2-342-2	B-342	White	22 to 16	0.046 (1.2) - 0.111 (2.8)	0.125 (3.2)	0.047 (1.2)	.020 (0.5) +/- .003 (0.07)	2	2000	B30-R4300
BBP33	Fig. 20	B33-187-2-342-2	B-342	White	20 to 10	0.062 (1.6) - 0.150 (3.8)	0.187 (4.7)	0.062 (1.6)	.020 (0.5) +/- .003 (0.07)	2	1500	B30-R4300
BBP33	Fig. 20	B33-250-2-342-2	B-342	White	16 to 8	0.094 (2.4) - 0.215 (5.5)	0.250 (6.4)	0.093 (2.4)	.025 (0.6) +/- .003 (0.07)	2	1000	B30-R4300
BBP33	Fig. 20	B33-375-2-342-2	B-342	White	12 to 4	0.125 (3.2) - 0.320 (8.1)	0.375 (9.5)	0.125 (3.1)	.025 (0.6) +/- .003 (0.07)	2	1000	B30-R4300
BBP33	Fig. 20-2	B33-500-2-342-2	B-342	White	8 to 1	0.187 (4.8) - 0.450 (11.4)	0.500 (12.7)	0.119 (3.0)	.025 (0.6) +/- .003 (0.07)	2	700	B30-R4300
BBP33	Fig. 20-2	B33-750-2-342-2	B-342	White	6 to 4/0	0.250 (6.4) - 0.700 (17.8)	0.750 (19.1)	0.250 (6.35)	.025 (0.6) +/- .003 (0.07)	2	500	B30-R4300
BBP33	Fig. 20-2	B33-1000-2-342-2	B-342	White	2 to 0.950 dia	0.333 (8.5) - 0.950 (24.1)	1.000 (25.4)	0.375 (9.5)	.036 (0.9) +/- .003 (0.07)	2	500	B30-R4300
BBP33	Fig. 20-2	B33-1500-2-342-2	B-342	White	n/a	0.500 (12.7) - 1.400 (35.6)	1.500 (38.1)	0.500 (12.7)	.035 (0.9) +/- .003 (0.07)	2	150	B30-R4300
BBP33	Fig. 20-2	B33-94-2-342YL-2	B-342	Yellow	28 to 20	0.023 (0.6) - 0.080 (2.0)	0.094 (2.4)	0.024 (0.6)	.024 (0.6) +/- .003 (0.07)	2	2000	B30-R4300
BBP33	Fig. 20-2	B33-125-2-342YL-2	B-342	Yellow	22 to 16	0.046 (1.2) - 0.111 (2.8)	0.125 (3.2)	0.047 (1.2)	.020 (0.5) +/- .003 (0.07)	2	2000	B30-R4300
BBP33	Fig. 20-2	B33-500-2-342YL-2	B-342	Yellow	8 to 1	0.187 (4.8) - 0.450 (11.4)	0.500 (12.7)	0.119 (3.0)	.025 (0.6) +/- .003 (0.07)	2	700	B30-R4300
BBP33	Fig. 20-2	B33-750-2-342YL-2	B-342	Yellow	6 to 4/0	0.250 (6.4) - 0.700 (17.8)	0.750 (19.1)	0.250 (6.35)	.025 (0.6) +/- .003 (0.07)	2	500	B30-R4300
BBP33	Fig. 20-2	B33-1000-2-342YL-2	B-342	Yellow	2 to 0.950 dia	0.333 (8.5) - 0.950 (24.1)	1.000 (25.4)	0.375 (9.5)	.036 (0.9) +/- .003 (0.07)	2	500	B30-R4300
BBP33	Fig. 20-2	B33-1500-2-342YL-2	B-342	Yellow	n/a	0.500 (12.7) - 1.400 (35.6)	1.500 (38.1)	0.500 (12.7)	.035 (0.9) +/- .003 (0.07)	2	300	B30-R4300

View all BBP<sup>®</sup>33 and BBP<sup>®</sup>33 Print Ribbon parts on page 379.

## PermaSleeve<sup>®</sup> PS Polyolefin Wire Marking Sleeves (Continued)

Fits Printer Model	Diagram	Catalog #	Material	Color	For Wire Gauge (approx.)	For Wire Diameters Inch (mm) Min. Max.	Supplied Diameter B Inch (mm)	Recovered Diameter Inch (mm)	Recovered Wall Thickness Inch (mm)	Sleeves Per Row	Per Roll	Rec. Ribbon
3:1 Shrink ratio double-side printable, 2" sleeve width (dimension A):												
BBP33	Fig. 20	B33D-94-2-342	B-342	White	28 to 20	0.023 (0.6) - 0.080 (2.0)	0.094 (2.4)	0.024 (0.6)	.024 (0.6) +/- .003 (0.07)	1	1000	B30-R4300
BBP33	Fig. 20	B33D-187-2-342	B-342	White	20 to 10	0.062 (1.6) - 0.150 (3.8)	0.187 (4.7)	0.062 (1.6)	.020 (0.5) +/- .003 (0.07)	1	750	B30-R4300
BBP33	Fig. 20	B33D-125-2-342	B-342	White	22 to 16	0.046 (1.2) - 1.110 (2.8)	0.125 (3.2)	0.047 (1.2)	.020 (0.5) +/- .003 (0.07)	1	1000	B30-R4300
BBP33	Fig. 20	B33D-250-2-342	B-342	White	16 to 8	0.094 (2.4) - 0.215 (5.5)	0.250 (6.4)	0.093 (2.4)	.025 (0.6) +/- .003 (0.07)	1	500	B30-R4300
BBP33	Fig. 20	B33D-375-2-342	B-342	White	12 to 4	0.125 (3.2) - 0.320 (8.1)	0.375 (9.5)	0.125 (3.1)	.025 (0.6) +/- .003 (0.07)	1	500	B30-R4300
BBP33	Fig. 20	B33D-500-2-342	B-342	White	8 to 1	0.187 (4.8) - 0.450 (11.4)	0.500 (12.7)	1.187 (4.7)	.025 (0.6) +/- .003 (0.07)	1	350	B30-R4300
BBP33	Fig. 20	B33D-750-2-342	B-342	White	6 to 4/0	0.250 (6.4) - 0.700 (17.8)	0.750 (19.0)	0.250 (6.4)	.025 (0.6) +/- .003 (0.07)	1	250	B30-R4300
BBP33	Fig. 20	B33D-1000-2-342	B-342	White	2 to 0.950 dia	0.333 (8.5) - 0.950 (24.1)	1.000 (25.4)	0.375 (9.5)	.036 (0.9) +/- .003 (0.07)	1	250	B30-R4300
BBP33	Fig. 20	B33D-1500-2-342	B-342	White	n/a	0.500 (12.7) - 1.400 (35.6)	1.500 (38.1)	0.500 (12.7)	.035 (0.9) +/- .003 (0.07)	1	150	B30-R4300
BBP33	Fig. 20	B33D-94-2-342YL	B-342	Yellow	28 to 20	0.023 (0.6) - 0.080 (2.0)	0.094 (2.4)	0.024 (0.6)	.024 (0.6) +/- .003 (0.07)	1	1000	B30-R4300
BBP33	Fig. 20	B33D-125-2-342YL	B-342	Yellow	22 to 16	0.046 (1.2) - 1.110 (2.8)	0.125 (3.2)	0.047 (1.2)	.020 (0.5) +/- .003 (0.07)	1	1000	B30-R4300
BBP33	Fig. 20	B33D-187-2-342YL	B-342	Yellow	20 to 10	0.062 (1.6) - 0.150 (3.8)	0.187 (4.7)	0.062 (1.6)	.020 (0.5) +/- .003 (0.07)	1	750	B30-R4300
BBP33	Fig. 20	B33D-250-2-342YL	B-342	Yellow	16 to 8	0.094 (2.4) - 0.215 (5.5)	0.250 (6.4)	0.093 (2.4)	.025 (0.6) +/- .003 (0.07)	1	500	B30-R4300
BBP33	Fig. 20	B33D-375-2-342YL	B-342	Yellow	12 to 4	0.125 (3.2) - 0.320 (8.1)	0.375 (9.5)	0.125 (3.1)	.025 (0.6) +/- .003 (0.07)	1	500	B30-R4300
BBP33	Fig. 20	B33D-500-2-342YL	B-342	Yellow	8 to 1	0.187 (4.8) - 0.450 (11.4)	0.500 (12.7)	1.187 (4.7)	.025 (0.6) +/- .003 (0.07)	1	350	B30-R4300
BBP33	Fig. 20	B33D-750-2-342YL	B-342	Yellow	6 to 4/0	0.250 (6.4) - 0.700 (17.8)	0.750 (19.0)	0.250 (6.4)	.025 (0.6) +/- .003 (0.07)	1	250	B30-R4300
BBP33	Fig. 20	B33D-1000-2-342YL	B-342	Yellow	2 to 0.950 dia	0.333 (8.5) - 0.950 (24.1)	1.000 (25.4)	0.375 (9.5)	.036 (0.9) +/- .003 (0.07)	1	250	B30-R4300
BBP33	Fig. 20	B33D-1500-2-342YL	B-342	Yellow	n/a	0.500 (12.7) - 1.400 (35.6)	1.500 (38.1)	0.500 (12.7)	.035 (0.9) +/- .003 (0.07)	1	150	B30-R4300
BBP33	Fig. 20	B33D-94-2-342BK	B-342	Black	28 to 20	0.023 (0.6) - 0.080 (2.0)	0.094 (2.4)	0.024 (0.6)	.024 (0.6) +/- .003 (0.07)	1	1000	B30-R4500-SV
BBP33	Fig. 20	B33D-125-2-342BK	B-342	Black	22 to 16	0.046 (1.2) - 1.110 (2.8)	0.125 (3.2)	0.047 (1.2)	.020 (0.5) +/- .003 (0.07)	1	1000	B30-R4500-SV
BBP33	Fig. 20	B33D-187-2-342BK	B-342	Black	20 to 10	0.062 (1.6) - 0.150 (3.8)	0.187 (4.7)	0.062 (1.6)	.020 (0.5) +/- .003 (0.07)	1	750	B30-R4500-SV
BBP33	Fig. 20	B33D-250-2-342BK	B-342	Black	16 to 8	0.094 (2.4) - 0.215 (5.5)	0.250 (6.4)	0.093 (2.4)	.025 (0.6) +/- .003 (0.07)	1	500	B30-R4500-SV
BBP33	Fig. 20	B33D-375-2-342BK	B-342	Black	12 to 4	0.125 (3.2) - 0.320 (8.1)	0.375 (9.5)	0.125 (3.1)	.025 (0.6) +/- .003 (0.07)	1	500	B30-R4500-SV
BBP33	Fig. 20	B33D-500-2-342BK	B-342	Black	8 to 1	0.187 (4.8) - 0.450 (11.4)	0.500 (12.7)	1.187 (4.7)	.025 (0.6) +/- .003 (0.07)	1	350	B30-R4500-SV
BBP33	Fig. 20	B33D-750-2-342BK	B-342	Black	6 to 4/0	0.250 (6.4) - 0.700 (17.8)	0.750 (19.0)	0.250 (6.4)	.025 (0.6) +/- .003 (0.07)	1	250	B30-R4500-SV
BBP33	Fig. 20	B33D-1000-2-342BK	B-342	Black	2 to 0.950 dia	0.333 (8.5) - 0.950 (24.1)	1.000 (25.4)	0.375 (9.5)	.036 (0.9) +/- .003 (0.07)	1	250	B30-R4500-SV
BBP33	Fig. 20	B33D-1500-2-342BK	B-342	Black	n/a	0.500 (12.7) - 1.400 (35.6)	1.500 (38.1)	0.500 (12.7)	.035 (0.9) +/- .003 (0.07)	1	150	B30-R4500-SV



### BBP<sup>®</sup>33 Prints Double-Sided Wire Sleeves!

#### Print double sided sleeves with no wasted labels!

Double sided sleeves are fast and easy with the BBP<sup>®</sup>33 printer. Use the appropriate double sided sleeve part and create your print job using LabelMark<sup>®</sup> software's "two-sided print" feature. After the first side of your print job is complete, the software prompts you to cut the media and re-insert it for a second print pass.



## PermaSleeve<sup>®</sup> HT High Temperature PVDF Wire Marking Sleeves (B-345)

High temperature, low outgassing. 2:1 Shrink ratio.

- A 2:1 shrink ratio wire marker sleeve specifically designed for high temperature and low vacuum outgassing applications
- Made from irradiated high-temp Polyvinylidene Fluoride (PVDF) heat shrink tubing
- Fade-resistant and flame-retardant
- Meets the following industry specifications:
  - NASA SP-R-0022A Outgassing Performance
  - Tested per ASTM E162, ASTM E662, SAE-AMS-DTL-23053/18 (class 2)
  - MIL-STD-202 - SAE-AS-81531

Service temp: -67°F to 437°F Agency Approvals for HT and HX Sleeves: RoHS

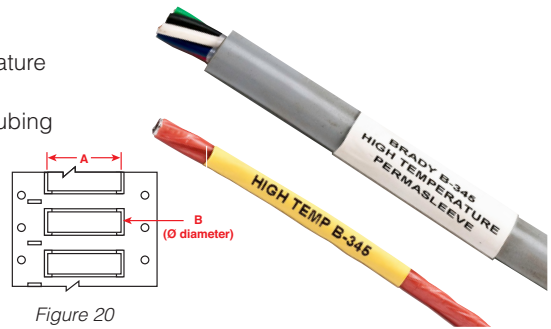

Figure 20

Fits Printer Model	Diagram	Catalog #	Material	Color	For Wire Gauge (approx.)	For Wire Diameters Inch (mm) Min. Max.	Supplied Diameter B Inch (mm)	Recovered Diameter Inch (mm)	Recovered Wall Thickness Inch (mm)	Sleeves Per Row	Sleeves Per Roll	Rec. Ribbon
<b>3:1 Shrink ratio double-side printable, 2" sleeve width (dimension A):</b>												
BBP33	Fig. 20	B33D-94-2-345	B-345	White	26 to 20	0.031 (0.8) - 0.080 (2.0)	0.094 (2.4)	0.031 (0.8)	.015 (0.4) +/- .003 (0.07)	1	1000	B30-R6000
BBP33	Fig. 20	B33D-94-2-345BK	B-345	Black	26 to 20	0.031 (0.8) - 0.080 (2.0)	0.094 (2.4)	0.031 (0.8)	.015 (0.4) +/- .003 (0.07)	1	1000	B30-R4400-WT
<b>2:1 Shrink ratio double-side printable, 2" sleeve width (dimension A):</b>												
BBP33	Fig. 20	B33D-125-2-345	B-345	White	20 to 16	0.063 (1.6) - 0.110 (2.8)	0.125 (3.2)	0.062 (1.6)	.015 (0.4) +/- .003 (0.07)	1	1000	B30-R6000
BBP33	Fig. 20	B33D-187-2-345	B-345	White	16 to 10	0.094 (2.4) - 0.150 (3.8)	0.187 (4.7)	0.093 (2.4)	.015 (0.4) +/- .003 (0.07)	1	750	B30-R6000
BBP33	Fig. 20	B33D-250-2-345	B-345	White	12 to 8	0.125 (3.2) - 0.215 (5.5)	0.250 (6.4)	0.125 (3.2)	.015 (0.4) +/- .003 (0.07)	1	500	B30-R6000
BBP33	Fig. 20	B33D-375-2-345	B-345	White	8 to 4	0.187 (3.2) - 0.320 (8.1)	0.375 (9.5)	0.187 (4.7)	.015 (0.4) +/- .003 (0.07)	1	500	B30-R6000
BBP33	Fig. 20	B33D-500-2-345	B-345	White	6 to 1	0.250 (6.4) - 0.450 (11.4)	0.500 (12.7)	0.250 (6.4)	.015 (0.4) +/- .003 (0.07)	1	350	B30-R6000
BBP33	Fig. 20	B33D-750-2-345	B-345	White	2 to 4/0	0.375 (9.5) - 0.700 (17.8)	0.750 (19.0)	0.375 (9.5)	.015 (0.4) +/- .003 (0.07)	1	250	B30-R6000
BBP33	Fig. 20	B33D-1000-2-345	B-345	White	2/0 to 0.950 dia	0.450 (11.4) - 0.950 (24.1)	1.000 (25.4)	0.500 (12.7)	.017 (0.4) +/- .004 (0.1)	1	250	B30-R6000
BBP33	Fig. 20	B33D-1500-2-345	B-345	White	N/A	0.750 (19.1) - 1.400 (35.6)	1.500 (38.1)	0.750 (19.1)	.024 (0.6) +/- .004 (0.1)	1	150	B30-R6000
BBP33	Fig. 20	B33D-125-2-345BK	B-345	Black	20 to 16	0.063 (1.6) - 0.110 (2.8)	0.125 (3.2)	0.062 (1.6)	.015 (0.4) +/- .003 (0.07)	1	1000	B30-R4400-WT
BBP33	Fig. 20	B33D-187-2-345BK	B-345	Black	16 to 10	0.094 (2.4) - 0.150 (3.8)	0.187 (4.7)	0.093 (2.4)	.015 (0.4) +/- .003 (0.07)	1	750	B30-R4400-WT
BBP33	Fig. 20	B33D-250-2-345BK	B-345	Black	12 to 8	0.125 (3.2) - 0.215 (5.5)	0.250 (6.4)	0.125 (3.2)	.015 (0.4) +/- .003 (0.07)	1	500	B30-R4400-WT
BBP33	Fig. 20	B33D-375-2-345BK	B-345	Black	8 to 4	0.187 (3.2) - 0.320 (8.1)	0.375 (9.5)	0.187 (4.7)	.015 (0.4) +/- .003 (0.07)	1	500	B30-R4400-WT
BBP33	Fig. 20	B33D-500-2-345BK	B-345	Black	6 to 1	0.250 (6.4) - 0.450 (11.4)	0.500 (12.7)	0.250 (6.4)	.015 (0.4) +/- .003 (0.07)	1	350	B30-R4400-WT
BBP33	Fig. 20	B33D-750-2-345BK	B-345	Black	3 to 4/0	0.375 (9.5) - 0.700 (17.8)	0.750 (19.0)	0.375 (9.5)	.015 (0.4) +/- .003 (0.07)	1	250	B30-R4400-WT
BBP33	Fig. 20	B33D-1000-2-345BK	B-345	Black	2/0 to 0.950 dia	0.450 (11.4) - 0.950 (24.1)	1.000 (25.4)	0.500 (12.7)	.017 (0.4) +/- .004 (0.1)	1	250	B30-R4400-WT
BBP33	Fig. 20	B33D-1500-2-345BK	B-345	Black	N/A	0.750 (19.1) - 1.400 (35.6)	1.500 (38.1)	0.750 (19.1)	.024 (0.6) +/- .004 (0.1)	1	150	B30-R4400-WT

## PermaSleeve<sup>®</sup> HX Polyolefin Wire Marking Sleeves (B-7642)

Military/Industrial Grade. 2:1 Shrink ratio.

- Flame retardant and high-temp rated but not as high temp as B-345 "HT" sleeves
- Meets the following industry specifications:
  - SAE-AMS-DTL-23053/5 (class 1 and 3) - SAE-AS-81531
  - MIL-STD-202 - Tested per ASTM E162, ASTM E662

Service temp: -40°F to 248°F (short burst max temp: 5 min at 464°F, 24 hrs at 320°F) RoHS

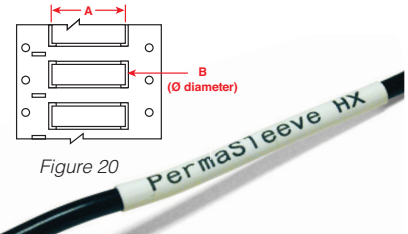

Figure 20

Fits Printer Model	Diagram	Catalog #	Material	Color	For Wire Gauge (approx.)	For Wire Diameters Inch (mm) Min. Max.	Supplied Diameter B Inch (mm)	Recovered Diameter Inch (mm)	Recovered Wall Thickness Inch (mm)	Sleeves Per Row	Sleeves Per Roll	Rec. Ribbon
<b>3:1 Shrink ratio single-side printable, 2" sleeve width (dimension A):</b>												
BBP33	Fig. 20	B33-94-2-7642	B-7642	White	24 to 20	0.047 (1.2) - 0.080 (2.0)	0.094 (2.4)	0.047 (1.2)	.020 (0.5) +/- .003 (0.07)	1	500	B30-R4300
BBP33	Fig. 20	B33-125-2-7642	B-7642	White	20 to 16	0.062 (1.6) - 0.110 (2.8)	0.125 (3.2)	0.063 (1.6)	.020 (0.5) +/- .003 (0.07)	1	500	B30-R4300
BBP33	Fig. 20	B33-187-2-7642	B-7642	White	16 to 10	0.094 (2.4) - 0.151 (3.8)	0.187 (4.8)	0.094 (2.4)	.020 (0.5) +/- .003 (0.07)	1	450	B30-R4300
BBP33	Fig. 20	B33-250-2-7642	B-7642	White	12 to 8	0.125 (3.2) - 0.215 (5.5)	0.250 (6.4)	0.126 (3.2)	.025 (0.6) +/- .003 (0.07)	1	400	B30-R4300
BBP33	Fig. 20	B33-375-2-7642	B-7642	White	8 to 4	0.188 (4.8) - 0.320 (8.1)	0.375 (9.5)	0.189 (4.8)	.025 (0.6) +/- .003 (0.07)	1	250	B30-R4300
BBP33	Fig. 20	B33-500-2-7642	B-7642	White	6 to 1	0.250 (6.4) - 0.450 (11.4)	0.500 (12.7)	0.252 (6.4)	.025 (0.6) +/- .003 (0.07)	1	225	B30-R4300
BBP33	Fig. 20	B33-750-2-7642	B-7642	White	2 to 4/0	0.375 (9.5) - 0.700 (17.8)	0.750 (19.0)	0.374 (9.5)	.030 (0.8) +/- .003 (0.07)	1	150	B30-R4300
BBP33	Fig. 20	B33-1000-2-7642	B-7642	White	2/0 to 0.950 dia	0.450 (11.4) - 0.950 (24.1)	1.000 (25.4)	0.500 (12.7)	.035 (0.9) +/- .005 (0.1)	1	150	B30-R4300
BBP33	Fig. 20	B33-1500-2-7642	B-7642	White	N/A	0.750 (19.0) - 1.400 (35.6)	1.500 (38.1)	0.752 (19.1)	.040 (1.0) +/- .006 (0.2)	1	50	B30-R4300
BBP33	Fig. 20	B33-2000-2-7642	B-7642	White	N/A	1.000 (25.4) - 1.900 (48.3)	2.000 (50.8)	1.000 (25.4)	.045 (1.1) +/- .007 (0.2)	1	50	B30-R4300
<b>3:1 Shrink ratio double-side printable, 2" sleeve width (dimension A):</b>												
BBP33	Fig. 20	B33D-94-2-7642	B-7642	White	24 to 20	0.047 (1.2) - 0.080 (2.0)	0.094 (2.4)	0.047 (1.2)	.020 (0.5) +/- .003 (0.07)	1	500	B30-R4300
BBP33	Fig. 20	B33D-125-2-7642	B-7642	White	20 to 16	0.062 (1.6) - 0.110 (2.8)	0.125 (3.2)	0.063 (1.6)	.020 (0.5) +/- .003 (0.07)	1	500	B30-R4300
BBP33	Fig. 20	B33D-187-2-7642	B-7642	White	16 to 10	0.094 (2.4) - 0.151 (3.8)	0.187 (4.8)	0.094 (2.4)	.020 (0.5) +/- .003 (0.07)	1	450	B30-R4300
BBP33	Fig. 20	B33D-250-2-7642	B-7642	White	12 to 8	0.125 (3.2) - 0.215 (5.5)	0.250 (6.4)	0.126 (3.2)	.025 (0.6) +/- .003 (0.07)	1	400	B30-R4300
BBP33	Fig. 20	B33D-375-2-7642	B-7642	White	8 to 4	0.188 (4.8) - 0.320 (8.1)	0.375 (9.5)	0.189 (4.8)	.025 (0.6) +/- .003 (0.07)	1	250	B30-R4300
BBP33	Fig. 20	B33D-500-2-7642	B-7642	White	6 to 1	0.250 (6.4) - 0.450 (11.4)	0.500 (12.7)	0.252 (6.4)	.025 (0.6) +/- .003 (0.07)	1	225	B30-R4300
BBP33	Fig. 20	B33D-750-2-7642	B-7642	White	2 to 4/0	0.375 (9.5) - 0.700 (17.8)	0.750 (19.0)	0.374 (9.5)	.030 (0.8) +/- .003 (0.07)	1	150	B30-R4300
BBP33	Fig. 20	B33D-1000-2-7642	B-7642	White	2/0 to 0.950 dia	0.450 (11.4) - 0.950 (24.1)	1.000 (25.4)	0.500 (12.7)	.035 (0.9) +/- .005 (0.1)	1	150	B30-R4300
BBP33	Fig. 20	B33D-1500-2-7642	B-7642	White	N/A	0.750 (19.0) - 1.400 (35.6)	1.500 (38.1)	0.752 (19.1)	.040 (1.0) +/- .006 (0.2)	1	50	B30-R4300
BBP33	Fig. 20	B33D-2000-2-7642	B-7642	White	N/A	1.000 (25.4) - 1.900 (48.3)	2.000 (50.8)	1.000 (25.4)	.045 (1.1) +/- .007 (0.2)	1	50	B30-R4300

View all BBP<sup>®</sup>33 and BBP<sup>®</sup>33 Print Ribbon parts on page 379.



## PermaSleeve<sup>®</sup> FR Fluid Resistant Wire Marking Sleeves (B-344)

**Military/Industrial Grade. 3:1 Shrink ratio.**

- Designed for labeling wires in applications where they will be exposed to fuels, lubricants and harsh chemicals such as in the installation of hydrogen fuel cells in aerospace
- Resistant to harsh chemicals including JP8 Jet Fuel, Skydrol<sup>®</sup> and DOT 3 brake fluid
- Meets the following industry specifications:
  - SAE-AMS-DTL-23053/6 (class 1)
  - MIL-STD-202G method 215K

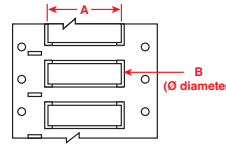

Figure 20



Service temp: -94°F to 267°F  
Agency Approvals for: **RoHS**

Fits Printer Model	Diagram	Catalog #	Material	Color	For Wire Gauge (approx.)	For Wire Diameters Inch (mm) Min. Max.	Supplied Diameter B Inch (mm)	Recovered Diameter Inch (mm)	Recovered Wall Thickness Inch (mm)	Sleeves Per Row	Sleeves Per Roll	Rec. Ribbon
<b>3:1 Shrink ratio double-side printable, 2" sleeve width (dimension A):</b>												
BBP33	Fig. 20	B33D-94-2-344	B-344	White	28 to 20	0.023 (0.6) - 0.080 (2.0)	0.094 (2.4)	0.024 (0.6)	0.024 (0.6) +/- 0.003 (0.1)	1	1000	B30-R6600
BBP33	Fig. 20	B33D-125-2-344	B-344	White	22 to 16	0.046 (1.2) - 0.111 (2.8)	0.125 (3.1)	0.047 (1.2)	0.020 (0.5) +/- 0.003 (0.1)	1	1000	B30-R6600
BBP33	Fig. 20	B33D-187-2-344	B-344	White	20 to 10	0.062 (1.6) - 0.15 (3.81)	0.187 (4.8)	0.062 (1.6)	0.020 (0.5) +/- 0.003 (0.1)	1	750	B30-R6600
BBP33	Fig. 20	B33D-250-2-344	B-344	White	16 to 8	0.094 (2.4) - 0.215 (5.5)	0.250 (6.35)	0.093 (2.4)	0.025 (0.6) +/- 0.003 (0.1)	1	500	B30-R6600
BBP33	Fig. 20	B33D-375-2-344	B-344	White	12 to 4	0.125 (3.2) - 0.320 (8.1)	0.375 (9.5)	0.125 (3.2)	0.025 (0.6) +/- 0.003 (0.1)	1	500	B30-R6600
BBP33	Fig. 20	B33D-500-2-344	B-344	White	8 to 1	0.187 (4.8) - 0.450 (11.4)	0.500 (12.7)	0.119 (3.0)	0.025 (0.6) +/- 0.003 (0.1)	1	350	B30-R6600
BBP33	Fig. 20	B33D-750-2-344	B-344	White	6 to 4/0	0.250 (6.4) - 0.700 (17.8)	0.750 (19.05)	0.250 (6.35)	0.025 (0.6) +/- 0.003 (0.1)	1	250	B30-R6600
BBP33	Fig. 20	B33D-1000-2-344	B-344	White	2 to 0.950 dia	0.333 (8.5) - 0.950 (24.1)	1.000 (25.4)	0.375 (9.5)	0.036 (0.9) +/- 0.003 (0.1)	1	250	B30-R6600
BBP33	Fig. 20	B33D-1500-2-344	B-344	White	n/a	0.500 (12.7) - 1.400 (35.6)	1.500 (38.1)	0.500 (12.7)	0.035 (0.9) +/- 0.003 (0.1)	1	150	B30-R6600
BBP33	Fig. 20	B33D-94-2-344YL	B-344	Yellow	28 to 20	0.023 (0.6) - 0.080 (2.0)	0.094 (2.4)	0.024 (0.6)	0.024 (0.6) +/- 0.003 (0.1)	1	1000	B30-R6600
BBP33	Fig. 20	B33D-125-2-344YL	B-344	Yellow	22 to 16	0.046 (1.2) - 0.111 (2.8)	0.125 (3.1)	0.047 (1.2)	0.020 (0.5) +/- 0.003 (0.1)	1	1000	B30-R6600
BBP33	Fig. 20	B33D-187-2-344YL	B-344	Yellow	20 to 10	0.062 (1.6) - 0.15 (3.81)	0.187 (4.8)	0.062 (1.6)	0.020 (0.5) +/- 0.003 (0.1)	1	750	B30-R6600
BBP33	Fig. 20	B33D-250-2-344YL	B-344	Yellow	16 to 8	0.094 (2.4) - 0.215 (5.5)	0.250 (6.35)	0.093 (2.4)	0.025 (0.6) +/- 0.003 (0.1)	1	500	B30-R6600
BBP33	Fig. 20	B33D-375-2-344YL	B-344	Yellow	12 to 4	0.125 (3.2) - 0.320 (8.1)	0.375 (9.5)	0.125 (3.2)	0.025 (0.6) +/- 0.003 (0.1)	1	500	B30-R6600
BBP33	Fig. 20	B33D-500-2-344YL	B-344	Yellow	8 to 1	0.187 (4.8) - 0.450 (11.4)	0.500 (12.7)	0.119 (3.0)	0.025 (0.6) +/- 0.003 (0.1)	1	350	B30-R6600
BBP33	Fig. 20	B33D-750-2-344YL	B-344	Yellow	6 to 4/0	0.250 (6.4) - 0.700 (17.8)	0.750 (19.05)	0.250 (6.35)	0.025 (0.6) +/- 0.003 (0.1)	1	250	B30-R6600
BBP33	Fig. 20	B33D-1000-2-344YL	B-344	Yellow	2 to 0.950 dia	0.333 (8.5) - 0.950 (24.1)	1.000 (25.4)	0.375 (9.5)	0.036 (0.9) +/- 0.003 (0.1)	1	250	B30-R6600
BBP33	Fig. 20	B33D-1500-2-344YL	B-344	Yellow	n/a	0.500 (12.7) - 1.400 (35.6)	1.500 (38.1)	0.500 (12.7)	0.035 (0.9) +/- 0.003 (0.1)	1	150	B30-R6600
BBP33	Fig. 20	B33D-94-2-344BK	B-344	Black	28 to 20	0.023 (0.6) - 0.080 (2.0)	0.094 (2.4)	0.024 (0.6)	0.024 (0.6) +/- 0.003 (0.1)	1	1000	B30-R6700-WT
BBP33	Fig. 20	B33D-125-2-344BK	B-344	Black	22 to 16	0.046 (1.2) - 0.111 (2.8)	0.125 (3.1)	0.047 (1.2)	0.020 (0.5) +/- 0.003 (0.1)	1	1000	B30-R6700-WT
BBP33	Fig. 20	B33D-187-2-344BK	B-344	Black	20 to 10	0.062 (1.6) - 0.15 (3.81)	0.187 (4.8)	0.062 (1.6)	0.020 (0.5) +/- 0.003 (0.1)	1	750	B30-R6700-WT
BBP33	Fig. 20	B33D-250-2-344BK	B-344	Black	16 to 8	0.094 (2.4) - 0.215 (5.5)	0.250 (6.35)	0.093 (2.4)	0.025 (0.6) +/- 0.003 (0.1)	1	500	B30-R6700-WT
BBP33	Fig. 20	B33D-375-2-344BK	B-344	Black	12 to 4	0.125 (3.2) - 0.320 (8.1)	0.375 (9.5)	0.125 (3.2)	0.025 (0.6) +/- 0.003 (0.1)	1	500	B30-R6700-WT
BBP33	Fig. 20	B33D-500-2-344BK	B-344	Black	8 to 1	0.187 (4.8) - 0.450 (11.4)	0.500 (12.7)	0.119 (3.0)	0.025 (0.6) +/- 0.003 (0.1)	1	350	B30-R6700-WT
BBP33	Fig. 20	B33D-750-2-344BK	B-344	Black	6 to 4/0	0.250 (6.4) - 0.700 (17.8)	0.750 (19.05)	0.250 (6.35)	0.025 (0.6) +/- 0.003 (0.1)	1	250	B30-R6700-WT
BBP33	Fig. 20	B33D-1000-2-344BK	B-344	Black	2 to 0.950 dia	0.333 (8.5) - 0.950 (24.1)	1.000 (25.4)	0.375 (9.5)	0.036 (0.9) +/- 0.003 (0.1)	1	250	B30-R6700-WT
BBP33	Fig. 20	B33D-1500-2-344BK	B-344	Black	n/a	0.500 (12.7) - 1.400 (35.6)	1.500 (38.1)	0.500 (12.7)	0.035 (0.9) +/- 0.003 (0.1)	1	150	B30-R6700-WT

View all BBP<sup>®</sup>33 and BBP<sup>®</sup>33 Print Ribbon parts on page 379.



# BBP<sup>®</sup>31 and BBP<sup>®</sup>33 Supply Kits

BradyID.com/bbp31

## Tape Starter Packs - Everything you need to start your labeling applications.

These kits offer a variety of the most common labels to get you up and running quickly and easily! Tape Starter Packs are also available packaged with the BBP<sup>®</sup>31 Label Printer.

Bentchtop Printers



### Arc Flash Warning Supply Kit

- (2) 4" x 6" B-595 ANSI Warning Header Label Roll
- (1) 2.25" x 3" B-595 ANSI Warning Header Label Roll
- (1) 1" x 4" B-593 White Raised Panel Label Roll
- (1) 2.2" B-595 Orange Label Roll
- (3) Black Print Ribbon

Catalog #	Description
B30KIT-ARCFASH-W	Arc Flash Warning Supply Kit
BBP31-ARCFASH-KIT	Arc Flash Warning Supply Kit w/ BBP <sup>®</sup> 31 Label Printer*



### Safety & Compliance Supply Kit

- (1) 4" x 6" B-595 ANSI Danger Header Label Roll
- (1) 4" x 6" B-595 ANSI Warning Header Label Roll
- (1) 4" x 6" B-595 ANSI Caution Header Label Roll
- (1) 4" x 6" B-595 ANSI Notice Header Label Roll
- (1) 4" B-526 Photoluminescent Label Roll
- (1) 4" x 6" B-595 RTK NFPA Diamond w/ Text Roll
- (2) Black Print Ribbon
- (1) Red Print Ribbon

Catalog #	Description
B30KIT-SFTY	Safety & Compliance Supply Kit
BBP31-SFTY-KIT	Safety & Compliance Supply Kit w/ BBP <sup>®</sup> 31 Label Printer*



### 5S Visual Workplace Supply Kit

- (1) 4" B-595 White Label Roll
- (1) 2.25" B-595 White Label Roll
- (1) 4" B-595 Yellow Label Roll
- (1) 2.25" B-595 Yellow Label Roll
- (1) 2.25" B-581 Repositionable white Label Roll
- (1) 1.125" B-581 Repositionable white Label Roll
- (1) 2.25" Magnetic white Label Roll
- (1) Blank Valve Tag Variety Pack - Large
- (1) Large Die Cut Labels for Valve Tags
- (1) 4" x 6" B-595 Caution Header Label Roll
- (2) Black Print Ribbon
- (1) Red Print Ribbon
- (1) Green Print Ribbon
- (1) Blue Print Ribbon

Catalog #	Description
B30KIT-LEANVW	5S Visual Workplace Supply Kit
BBP31-LEANVW-KIT	5S Visual Workplace Supply Kit w/ BBP <sup>®</sup> 31 Label Printer*



### Pipe Identification Supply Kit

- (1) 4" B-595 Yellow Label Roll
- (1) 2.25" B-595 Yellow Label Roll
- (1) 1.125" B-595 Yellow Label Roll
- (1) 4" B-595 Green Label Roll
- (1) 2.25" B-595 Green Label Roll
- (1) 1.125" B-595 Green Label Roll
- (1) 1.125" B-595 Blue Label Roll
- (1) 2.25" B-595 Red Label Roll
- (1) 1.125" B-595 Red Label Roll
- (1) 1" x 4" B-593 Black Raised Panel Label Roll
- (1) Blank Valve Tag Variety Pack - Small
- (1) Small Die Cut Labels for Valve Tags
- (3) Black Print Ribbon
- (2) White Print Ribbon

Catalog #	Description
B30KIT-PIPE	Pipe Identification Supply Kit
BBP31-PIPE-KIT	Pipe Identification Supply Kit w/ BBP <sup>®</sup> 31 Label Printer*



### General Industrial & 5S Supply Kit

- (1) 4" B-595 White Label Roll
- (1) 2.25" B-595 White Label Roll
- (1) 1.125" B-595 White Label Roll
- (1) 4" B-595 Yellow Label Roll
- (1) 2.25" B-595 Yellow Label Roll
- (1) 1.125" B-595 Yellow Label Roll
- (1) 2.5" x 3" B-593 Black Raised Panel Label Roll
- (1) 4" x 6" B-595 ANSI Danger Header Label Roll
- (1) 4" x 6" B-595 ANSI Caution Header Label Roll
- (1) 2.25" Reflective Yellow Label Roll
- (1) 4.25" White Tag Stock Roll
- (2) Black Print Ribbon
- (1) White Print Ribbon
- (1) Red Print Ribbon

Catalog #	Description
B30KIT-GENIND	General Industrial & 5S Supply Kit
BBP31-GENIND-KIT	General Industrial & 5S Supply Kit w/ BBP <sup>®</sup> 31 Label Printer*

\* Printer ships with power cord, USB cable, drivers CD, stylus, cleaning kit, cutter cleaning tool, quick start guide and documentation holder.

# BBP®31 and BBP®33 Print Ribbons

BradyID.com/bbp31



Installs in 5 seconds and the ink always faces the right direction!



## Print Ribbons

“Drop & Click” print ribbons for 5 second ribbon supply changes.

- Tough, smear-proof ribbons that produce long-lasting printed text and can withstand years in industrial areas and outdoor conditions
- Self-contained cartridges drop straight into printer with a “click”
- No calibrating, no threading, no wasted feeding, no hassles, and the ink will always be facing the right direction!
- Printer notifies user if installed ribbon is not recommended for installed labels

Catalog #	Color
4.330" x 200' Heavy-duty ribbons for outdoor & harsh facility materials:	
B30-R10000	Black
B30-R10000-WT	White
B30-R10000-RD	Red
B30-R10000-GN	Green
B30-R10000-BL	Blue
B30-R10000-YL	Yellow***
B30-R10000-YL2	Yellow***
B30-R10000-OR	Orange
B30-R10000-MA	Magenta

Catalog #	Color
4.330" x 200' Industrial grade print ribbons:	
B30-R4300	Black
B30-R6000	Black
B30-R6200	Black
B30-R6400	Black
B30-R6600	Black
B30-R4400-WT	White
B30-R6700-WT	White
B30-R4500-SV	Silver*

\* B30-R4500-SV for use with B-342 black PermaSleeves only.

\*\*\* For printing yellow onto white B-595 use B30-R10000-YL. For printing yellow onto other colors of B-595 use B30-R10000-YL2.

## BBP®31 & BBP®33 Print Ribbon / Material Compatibility (Updated September 2014)

Recommendations below assume current firmware version. Visit BradyID.com/bbp33 for free upgrade via download.

B-# Material	BBP®31 & BBP®33 Print Ribbons													
	B30-R4300 (Black)	B30-R6000 (Black)	B30-R6200 (Black)	B30-R6400 (Black)	B30-R6600 (Black)	B30-R10000 (Black)	B30-R10000-WT (White)	B30-R4400-WT (White)	B30-R6700-WT (White)	B30-R10000-YL (Yellow)	B30-R10000-YL2 (Yellow)	B30-R10000 (Colors)	B30-R4500-SV (Silver)	
B-342 PermaSleeve® PS Wire Markers	●	—	—	—	—	●	—	—	—	—	—	—	—	●*
B-344 PermaSleeve® FR Wire Markers	—	—	—	—	—	●	—	—	—	—	—	—	—	—
B-345 PermaSleeve® HT Wire Markers	—	●	—	—	—	●	—	—	●*	—	—	—	—	—
B-422 Glossy White Polyester	—	●	—	—	—	—	—	—	—	—	—	—	—	—
B-423 Glossy White Polyester	—	●	●	—	—	—	—	—	—	—	—	—	—	—
B-424 Matte White Paper	●	—	—	—	—	—	—	—	—	—	—	—	—	—
B-425 Matte White Polypropylene	●	—	—	—	●	—	—	—	—	—	—	—	—	—
B-427 Vinyl Self-Laminating	●	—	—	—	—	—	—	—	—	—	—	—	—	—
B-428 Metallized Polyester	●	—	—	—	—	—	—	—	—	—	—	—	—	—
B-430 Glossy Clear Polyester	—	●	●	—	—	—	—	—	—	—	—	—	—	—
B-432 Glossy Clear Polyester	—	●	—	—	—	—	—	—	—	—	—	—	—	—
B-434 Glossy Metallized Polyester	—	●	—	—	—	—	—	—	—	—	—	—	—	—
B-435 Glossy Metallized Polyester	—	●	—	—	—	—	—	—	—	—	—	—	—	—
B-437 Tedlar®	●	—	—	—	—	—	—	—	—	—	—	—	—	—
B-438 Tamper Evident Metallized Polyester	●	—	—	—	—	—	—	—	—	—	—	—	—	—
B-472 Topcoated Polyimide	●	—	—	—	—	—	—	—	—	—	—	—	—	—
B-483 Glossy White Polyester	—	●	—	—	—	—	—	—	—	—	—	—	—	—
B-484 Glossy White Polyester	—	●	—	—	—	—	—	—	—	—	—	—	—	—
B-486 Matte Metallized Polyester	●	—	—	—	—	—	—	—	—	—	—	—	—	—
B-489 Matte White Polyester	●	—	—	—	—	—	—	—	—	—	—	—	—	—
B-498 Repositionable Coated Vinyl Cloth	●	—	●	—	—	—	—	—	—	—	—	—	—	—
B-499 Coated Nylon Cloth	—	●	—	—	—	—	—	—	—	—	—	—	—	—
B-509 Printable Magnetic	—	●	—	—	—	●	—	—	—	—	—	—	●**	—
B-526 Photoluminescent Polyester	—	●	—	—	—	●	—	—	—	—	—	—	●**	—
B-549 Cold Temp Polyester	—	●	—	—	—	●	●	—	—	—	—	—	●**	—
B-551 Non-Adhesive Tag	—	●	—	—	—	●	—	—	—	—	—	—	●**	—
B-565 Metallized Polyester	●	—	—	—	—	—	—	—	—	—	—	—	—	—
B-569 Low-Halide Polyester	—	●	—	—	—	●	●	—	—	—	—	—	●**	—
B-581 Repositionable Vinyl	—	●	—	—	—	●	●	—	—	—	—	—	●**	—
B-584 Retro Reflective	—	●	—	—	—	●	—	—	—	—	—	—	●**	—
B-593 Raised Panel Engraved Plate Substitute	—	●	—	—	—	—	●	—	—	—	—	—	—	—
B-595 Outdoor Vinyl	—	●	—	—	—	●	●	—	—	●***	●***	—	●**	—
B-854 Toughwash™ Metal Detectable	—	●	—	—	—	—	—	—	—	—	—	—	—	—
B-855 Toughwash™	—	●	—	—	—	—	—	—	—	—	—	—	—	—
B-717 Glossy Static Dissipative Polyimide	—	●	—	—	—	—	—	—	—	—	—	—	—	—
B-718 Glossy Low Profile Static Dissipative Polyimide	—	●	—	—	—	—	—	—	—	—	—	—	—	—
B-719 Matte Low Profile Static Dissipative Polyimide	—	●	—	—	—	—	—	—	—	—	—	—	—	—
B-724 Matte Amber Polyimide	●	—	—	—	—	—	—	—	—	—	—	—	—	—
B-727 Glossy White Polyimide	—	●	—	—	—	—	—	—	—	—	—	—	—	—
B-7642 PermaSleeve® HX Wire Markers	●	—	—	—	●	—	—	—	—	—	—	—	—	—

Refer to the corresponding Tech Data Sheets for complete material information at BradyID.com/techdata.

\*B30-R4500-SV ribbon for use with B-342 black PermaSleeves® only; B30-R4400-WT ribbon for use with B-345 black PermaSleeves® only.

\*\*Colored ribbons optimized for use on white material. Test use on other material colors for suitability to your application.

\*\*\*For printing yellow onto white B-595 use B30-R10000-YL. For printing yellow onto other colors of B-595 use B30-R10000-YL2.



# GlobalMark®2 Industrial Label Maker

BradyID.com/globalmark

Benchtop Printers



BRADY 360  
**5 YEAR**  
WARRANTY

## GLOBALMARK<sup>®</sup>2 INDUSTRIAL LABEL MAKER

### Get the message right...and get it out now with the GlobalMark®2 Industrial Label Maker.

Exactly the message you need, when you need it. When you need a sign or label, you need it now – you don't want to wait a day or a week for a custom order. With the GlobalMark®2 Industrial Label Maker Wizards, just touch, print, and get the message you need – right now – with built-in templates and graphics,

### Easy, versatile, customized signs & labels.

With built-in templates, graphics, and applications, you can quickly and easily create pipe markers, safety signs, hazardous labels, tags, equipment and warehouse marking, and more. You can even create custom templates!

The features you need at your fingertips:

- English, Spanish, French Languages Built In
- Print Size .08" to 3.8"
- 5 Fonts Built In
- Bar Codes 128, 39 and Int. 2 of 5 Built In
- Tape Widths 1/2" to 4"
- Clear Label Preview Before Printing
- Sharp 300 DPI Print Resolution
- Large Color Touch Screen
- Full Size Keyboard
- XY Axis Plotter/Cutter on Color & Cut Model - Die cuts 0.08" to 3.8"
- Compact Flash Memory Card Port
- Touch-and-Drag Editing
- Stand-Alone Operation or PC-Connect Operation



#### View Online!

Visit [BradyID.com/globalmark](http://BradyID.com/globalmark) for more information on the GlobalMark®2 Industrial Label Maker.

#### Your Complete Printing Solution:

GlobalMark®2 Label Rolls ..... Page 380  
GlobalMark®2 Print Ribbons..... Page 389

### Choose from 2 GlobalMark® models that meet all your labeling requirements

#### COLOR&CUT

- Prints in one color, multiple spot colors, blended colors and full process color
- Additional built-in plotter cutter for cutting out characters, text, shapes and multi-up labels
- With optional MarkWare™ label making software, import and print full color logos, artwork, even photographs

#### MULTI COLOR

- Prints the same color options as the Color & Cut system, including the optional MarkWare™ software enhancements, without the additional built-in plotter cutter



### Look what GlobalMark® can do for you...



Pipe Markers  
a(1/2" to 4")



Valve Tags



Equipment I.D.



RTK Chemical Labels



Cut Out  
Shapes & Text



Multiple Print Colors

GlobalMark® Printer Specifications	
<b>Description</b>	Rugged Safety & Facility ID printer with advanced capabilities of printing multiple print colors onto a label and cutting out basic shapes & text. Ideal for Lean, 5S, gauge labels and Plant Reliability labeling programs as well as pipe marking and general facility ID
<b>Applications &amp; Comments</b>	Facility & safety ID, signs, pipe markers, lean/5S, arc flash labels, GHS & chemical labels, equipment labels, panel labels, reflective & glow-in-the-dark labels, tagging, magnetic and cold-temp labeling.
<b>Label Material Types</b>	Extremely aggressive 8-10 year outdoor vinyl with high tack and chemical resistance, plus, wash down material, reflective, 10-hour glow-in-the-dark and 9 other materials
<b>Types of labels available</b>	Continuous material, pre-printed die cut labels
<b>Print Technology</b>	Thermal Transfer
<b>Print Resolution</b>	300 dpi
<b>Max Print Width</b>	4.000"
<b>Media Widths</b>	0.500" to 4.250"
<b>Minimum Label Dimension</b>	0.500"
<b>Color Printing Capabilities</b>	Multiple print colors on a label (some pre-printed multicolor supplies also available)
<b>Auto Cut-off</b>	Yes
<b>X-Y Plotter Cutting (cutting out shapes &amp; text)</b>	Yes (Color & Cut model)
<b>PC Connect or Stand Alone Operation</b>	PC Connect and Stand Alone
<b>Ribbon &amp; label roll installation</b>	<b>Labels:</b> Supplied in cartridge, drops into place, 15 sec changeover <b>Ribbon:</b> Supplied in cartridge, snaps into place, 5 sec changeover
<b>Calibration Required?</b>	No (no waste)
<b>Label creation &amp; set-up</b>	Automatic (printer or PC reads data on chip and automatically sets up label size, color, fonts, etc.)
<b>Connectivity Options</b>	Standard: USB
<b>Compatible Software</b>	Brady Workstation Apps, MarkWare™ Software, Windows® based driver for 3rd party software use*
<b>Warranty</b>	5 years



## GlobalMark®2 Label Maker and Accessories

Catalog #	Description
76801	GlobalMark2 Color & Cut Label Maker*
76800	GlobalMark2 MultiColor Label Maker *
134107	GlobalMark2 Color & Cut Label Maker* with MarkWare Standard Software
134108	GlobalMark2 Color & Cut Label Maker* with MarkWare Lean Software
134105	GlobalMark2 MultiColor Label Maker * with MarkWare Standard Software
134106	GlobalMark2 MultiColor Label Maker * with MarkWare Lean Software
120994	Rolling case w/ handle and supplies pockets for benchtop printers
76808	Mouse
STYLUS-3PK	Stylus Pens (3 pack)
64MB-CF	256MB Memory Card
76811	Replacement Cutting Blade
76737	Transfer Tape (4.25" x 200 ft.)
20596	Grommets for Tags (100/pk)
20591	Hole Punch for Tags
81762	8" Nylon Cable Ties (100/pk)

\* Printer includes a keyboard, power cord, cleaning kit, USB cable and Brady File Management Utility.

## GlobalMark®2 PC-Connect Software Solutions:



### Brady Workstation Apps

Brady has revolutionized its label creation software by now offering apps specific to your projects.

Once the free Brady Workstation is installed on your PC, you can then download a variety of free or paid labeling apps including Custom Label Designer, Express Signs, Pipe Markers, Lockout Writer and GHS.

View page 404 or download at [workstation.bradyyd.com](http://workstation.bradyyd.com)



### MarkWare™ Facility Identification Software

CD-based software option for creating custom safety signs & labels including pipe markers, ANSI signs, lockout tags, GHS labels, RTK chemical labels, lean 5S visuals and custom labels with barcodes and graphics. Built-in graphics and 2,000 chemical database for RTK. Pre-formatted GHS label templates. View page 405 for more information.

## Brady360® 5 Year Warranty We have you Covered.

We always stand behind our products to make sure they deliver you an unrivaled customer experience.

We've strengthened our commitment to you with a **5-year printer warranty standard and free of charge**

on our benchtop printer models.\* With a team of 30 certified tech support and repair technicians and our 5-year warranty backing you up, you can rest assured you'll have the support you need—every step of the way.

### Free 5-year warranty standard on Benchtop models\* covers:

- Repair parts & labor
- One print head replacement
- Free loaner printer during repairs
- Free return shipping after repair
- Free Brady 360® stress-free printer setup session
- Free lifetime technical support via phone and email
- Free lifetime firmware upgrades
- One free Brady 360® preventative maintenance service

### Access to additional fee-based support:

- On-site repair service
- On-site custom set-up and training
- Additional print head coverage (after the first free replacement)
- Advanced custom integration, programming support and template creation

\*Excludes repairs due to negligence. Excludes Wraptor™ model and handheld models. See [BradyID.com/brady360](http://BradyID.com/brady360) for full coverage details & restrictions.



# GlobalMark®2 Label Materials

BradyID.com/globalmark

## Indoor/Outdoor Grade Vinyl Tape (B-595)

- Conforms well to irregular, curved, rough and highly textured surfaces
- Low-shrink vinyl minimizes the amount of unsightly dust and grime buildup often found around the edges of other vinyl labeling supplies
- 8-10 year average outdoor durability in temperatures from -40°F to 180°F (-40°C to 82°C). Labels can be applied in temperatures from 0°F to 180°F
- Patent Number D481.414



Figure 33



Diagram	Catalog #	B#	Color	Label Width A Inch (mm)	Roll Length B Feet (m)	Labels Per Roll	Rec. Ribbon
Fig. 33	113109	B-595	White	4.000 (101.6)	100ft. (30.5m)	1 Roll (cont.)	76739
Fig. 33	113110	B-595	White	3.000 (76.2)	100ft. (30.5m)	1 Roll (cont.)	76739
Fig. 33	113111	B-595	White	2.250 (57.5)	100ft. (30.5m)	1 Roll (cont.)	76739
Fig. 33	113112	B-595	White	1.125 (28.6)	100ft. (30.5m)	1 Roll (cont.)	76739
Fig. 33	113113	B-595	White	0.500 (12.7)	100ft. (30.5m)	1 Roll (cont.)	76739
Fig. 33	113114	B-595	Yellow	4.000 (101.6)	100ft. (30.5m)	1 Roll (cont.)	76739
Fig. 33	113115	B-595	Yellow	3.000 (76.2)	100ft. (30.5m)	1 Roll (cont.)	76739
Fig. 33	113116	B-595	Yellow	2.250 (57.5)	100ft. (30.5m)	1 Roll (cont.)	76739
Fig. 33	113117	B-595	Yellow	1.125 (28.6)	100ft. (30.5m)	1 Roll (cont.)	76739
Fig. 33	113118	B-595	Yellow	0.500 (12.7)	100ft. (30.5m)	1 Roll (cont.)	76739
Fig. 33	113119	B-595	Red	4.000 (101.6)	100ft. (30.5m)	1 Roll (cont.)	76741
Fig. 33	113120	B-595	Red	2.250 (57.5)	100ft. (30.5m)	1 Roll (cont.)	76741
Fig. 33	113121	B-595	Red	1.125 (28.6)	100ft. (30.5m)	1 Roll (cont.)	76741
Fig. 33	113122	B-595	Red	0.500 (12.7)	100ft. (30.5m)	1 Roll (cont.)	76741
Fig. 33	113127	B-595	Blue	4.000 (101.6)	100ft. (30.5m)	1 Roll (cont.)	76741
Fig. 33	113128	B-595	Blue	2.250 (57.5)	100ft. (30.5m)	1 Roll (cont.)	76741
Fig. 33	113129	B-595	Blue	1.125 (28.6)	100ft. (30.5m)	1 Roll (cont.)	76741
Fig. 33	113130	B-595	Blue	0.500 (12.7)	100ft. (30.5m)	1 Roll (cont.)	76741
Fig. 33	113123	B-595	Green	4.000 (101.6)	100ft. (30.5m)	1 Roll (cont.)	76741
Fig. 33	113124	B-595	Green	2.250 (57.5)	100ft. (30.5m)	1 Roll (cont.)	76741
Fig. 33	113125	B-595	Green	1.125 (28.6)	100ft. (30.5m)	1 Roll (cont.)	76741
Fig. 33	113126	B-595	Green	0.500 (12.7)	100ft. (30.5m)	1 Roll (cont.)	76741
Fig. 33	113131	B-595	Black	4.000 (101.6)	100ft. (30.5m)	1 Roll (cont.)	76741
Fig. 33	113132	B-595	Black	2.250 (57.5)	100ft. (30.5m)	1 Roll (cont.)	76741
Fig. 33	113133	B-595	Black	1.125 (28.6)	100ft. (30.5m)	1 Roll (cont.)	76741
Fig. 33	113134	B-595	Black	0.500 (12.7)	100ft. (30.5m)	1 Roll (cont.)	76741
Fig. 33	113135	B-595	Brown	4.000 (101.6)	100ft. (30.5m)	1 Roll (cont.)	76741
Fig. 33	113136	B-595	Brown	2.250 (57.5)	100ft. (30.5m)	1 Roll (cont.)	76741
Fig. 33	113137	B-595	Brown	1.125 (28.6)	100ft. (30.5m)	1 Roll (cont.)	76741
Fig. 33	113138	B-595	Brown	0.500 (12.7)	100ft. (30.5m)	1 Roll (cont.)	76741
Fig. 33	113139	B-595	Gold	4.000 (101.6)	100ft. (30.5m)	1 Roll (cont.)	76739
Fig. 33	113140	B-595	Gold	2.250 (57.5)	100ft. (30.5m)	1 Roll (cont.)	76739
Fig. 33	113141	B-595	Gold	1.125 (28.6)	100ft. (30.5m)	1 Roll (cont.)	76739
Fig. 33	113142	B-595	Gold	0.500 (12.7)	100ft. (30.5m)	1 Roll (cont.)	76739
Fig. 33	113143	B-595	Grey	4.000 (101.6)	100ft. (30.5m)	1 Roll (cont.)	76739
Fig. 33	113144	B-595	Grey	2.250 (57.5)	100ft. (30.5m)	1 Roll (cont.)	76739
Fig. 33	113145	B-595	Grey	1.125 (28.6)	100ft. (30.5m)	1 Roll (cont.)	76739
Fig. 33	113146	B-595	Grey	0.500 (12.7)	100ft. (30.5m)	1 Roll (cont.)	76739
Fig. 33	113147	B-595	Purple	4.000 (101.6)	100ft. (30.5m)	1 Roll (cont.)	76741
Fig. 33	113148	B-595	Purple	2.250 (57.5)	100ft. (30.5m)	1 Roll (cont.)	76741
Fig. 33	113149	B-595	Purple	1.125 (28.6)	100ft. (30.5m)	1 Roll (cont.)	76741
Fig. 33	113150	B-595	Purple	0.500 (12.7)	100ft. (30.5m)	1 Roll (cont.)	76741
Fig. 33	113151	B-595	Orange	4.000 (101.6)	100ft. (30.5m)	1 Roll (cont.)	76739
Fig. 33	113152	B-595	Orange	2.250 (57.5)	100ft. (30.5m)	1 Roll (cont.)	76739
Fig. 33	113153	B-595	Orange	1.125 (28.6)	100ft. (30.5m)	1 Roll (cont.)	76739
Fig. 33	113154	B-595	Orange	0.500 (12.7)	100ft. (30.5m)	1 Roll (cont.)	76739
Fig. 33	113105	B-595	Clear	4.000 (101.6)	100ft. (30.5m)	1 Roll (cont.)	76739
Fig. 33	113106	B-595	Clear	2.250 (57.5)	100ft. (30.5m)	1 Roll (cont.)	76739
Fig. 33	113107	B-595	Clear	1.125 (28.6)	100ft. (30.5m)	1 Roll (cont.)	76739
Fig. 33	113108	B-595	Clear	0.500 (12.7)	100ft. (30.5m)	1 Roll (cont.)	76739

View all GlobalMark® Print Ribbon parts on page 389.

## Polyester Tape (B-569)

- Outdoor Grade
- Best choice for marking stainless steel pipes & surfaces (low halide content)
- Ultra-smooth finish excellent for mounting to rigid panels & very smooth surfaces.
- Applies best to very smooth surfaces

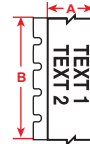

Figure 33



Diagram	Catalog #	B#	Color	Label Width A Inch (mm)	Roll Length B Feet (m)	Labels Per Roll	Rec. Ribbon
Fig.33	76614	B-569	White	4.000 (101.6)	100ft. (30.5m)	1 Roll (cont.)	76739
Fig.33	76615	B-569	White	3.000 (76.2)	100ft. (30.5m)	1 Roll (cont.)	76739
Fig.33	76616	B-569	White	2.250 (57.5)	100ft. (30.5m)	1 Roll (cont.)	76739
Fig.33	76617	B-569	White	1.125 (28.6)	100ft. (30.5m)	1 Roll (cont.)	76739
Fig.33	76618	B-569	White	0.500 (12.7)	100ft. (30.5m)	1 Roll (cont.)	76739
Fig.33	76619	B-569	Yellow	4.000 (101.6)	100ft. (30.5m)	1 Roll (cont.)	76739
Fig.33	76620	B-569	Yellow	2.250 (57.5)	100ft. (30.5m)	1 Roll (cont.)	76739
Fig.33	76621	B-569	Yellow	1.125 (28.6)	100ft. (30.5m)	1 Roll (cont.)	76739
Fig.33	76622	B-569	Yellow	0.500 (12.7)	100ft. (30.5m)	1 Roll (cont.)	76739
Fig.33	76623	B-569	Red	4.000 (101.6)	100ft. (30.5m)	1 Roll (cont.)	76741
Fig.33	76624	B-569	Red	2.250 (57.5)	100ft. (30.5m)	1 Roll (cont.)	76741
Fig.33	76625	B-569	Red	1.125 (28.6)	100ft. (30.5m)	1 Roll (cont.)	76741
Fig.33	76626	B-569	Red	0.500 (12.7)	100ft. (30.5m)	1 Roll (cont.)	76741
Fig.33	76627	B-569	Blue	4.000 (101.6)	100ft. (30.5m)	1 Roll (cont.)	76741
Fig.33	76628	B-569	Blue	2.250 (57.5)	100ft. (30.5m)	1 Roll (cont.)	76741
Fig.33	76629	B-569	Blue	1.125 (28.6)	100ft. (30.5m)	1 Roll (cont.)	76741
Fig.33	76630	B-569	Blue	0.500 (12.7)	100ft. (30.5m)	1 Roll (cont.)	76741
Fig.33	76639	B-569	Green	4.000 (101.6)	100ft. (30.5m)	1 Roll (cont.)	76741
Fig.33	76640	B-569	Green	2.250 (57.5)	100ft. (30.5m)	1 Roll (cont.)	76741
Fig.33	76641	B-569	Green	1.125 (28.6)	100ft. (30.5m)	1 Roll (cont.)	76741
Fig.33	76642	B-569	Green	0.500 (12.7)	100ft. (30.5m)	1 Roll (cont.)	76741
Fig.33	76647	B-569	Black	4.000 (101.6)	100ft. (30.5m)	1 Roll (cont.)	76741
Fig.33	76648	B-569	Black	2.250 (57.5)	100ft. (30.5m)	1 Roll (cont.)	76741
Fig.33	76649	B-569	Black	1.125 (28.6)	100ft. (30.5m)	1 Roll (cont.)	76741
Fig.33	76650	B-569	Black	0.500 (12.7)	100ft. (30.5m)	1 Roll (cont.)	76741
Fig.33	76643	B-569	Brown	4.000 (101.6)	100ft. (30.5m)	1 Roll (cont.)	76741
Fig.33	76644	B-569	Brown	2.250 (57.5)	100ft. (30.5m)	1 Roll (cont.)	76741
Fig.33	76645	B-569	Brown	1.125 (28.6)	100ft. (30.5m)	1 Roll (cont.)	76741
Fig.33	76646	B-569	Brown	0.500 (12.7)	100ft. (30.5m)	1 Roll (cont.)	76741
Fig.33	76602	B-569	Tan	4.000 (101.6)	100ft. (30.5m)	1 Roll (cont.)	76739
Fig.33	76603	B-569	Tan	2.250 (57.5)	100ft. (30.5m)	1 Roll (cont.)	76739
Fig.33	76604	B-569	Tan	1.125 (28.6)	100ft. (30.5m)	1 Roll (cont.)	76739
Fig.33	76605	B-569	Tan	0.500 (12.7)	100ft. (30.5m)	1 Roll (cont.)	76739
Fig.33	76651	B-569	Grey	4.000 (101.6)	100ft. (30.5m)	1 Roll (cont.)	76739
Fig.33	76652	B-569	Grey	2.250 (57.5)	100ft. (30.5m)	1 Roll (cont.)	76739
Fig.33	76653	B-569	Grey	1.125 (28.6)	100ft. (30.5m)	1 Roll (cont.)	76739
Fig.33	76654	B-569	Grey	0.500 (12.7)	100ft. (30.5m)	1 Roll (cont.)	76739
Fig.33	76631	B-569	Purple	4.000 (101.6)	100ft. (30.5m)	1 Roll (cont.)	76741
Fig.33	76632	B-569	Purple	2.250 (57.5)	100ft. (30.5m)	1 Roll (cont.)	76741
Fig.33	76633	B-569	Purple	1.125 (28.6)	100ft. (30.5m)	1 Roll (cont.)	76741
Fig.33	76634	B-569	Purple	0.500 (12.7)	100ft. (30.5m)	1 Roll (cont.)	76741
Fig.33	76635	B-569	Orange	4.000 (101.6)	100ft. (30.5m)	1 Roll (cont.)	76739
Fig.33	76636	B-569	Orange	2.250 (57.5)	100ft. (30.5m)	1 Roll (cont.)	76739
Fig.33	76637	B-569	Orange	1.125 (28.6)	100ft. (30.5m)	1 Roll (cont.)	76739
Fig.33	76638	B-569	Orange	0.500 (12.7)	100ft. (30.5m)	1 Roll (cont.)	76739
Fig.33	76598	B-569	Pink	4.000 (101.6)	100ft. (30.5m)	1 Roll (cont.)	76739
Fig.33	76599	B-569	Pink	2.250 (57.5)	100ft. (30.5m)	1 Roll (cont.)	76739
Fig.33	76600	B-569	Pink	1.125 (28.6)	100ft. (30.5m)	1 Roll (cont.)	76739
Fig.33	76601	B-569	Pink	0.500 (12.7)	100ft. (30.5m)	1 Roll (cont.)	76739
Fig.33	76606	B-569	Lt. Blue	4.000 (101.6)	100ft. (30.5m)	1 Roll (cont.)	76741
Fig.33	76607	B-569	Lt. Blue	2.250 (57.5)	100ft. (30.5m)	1 Roll (cont.)	76741
Fig.33	76608	B-569	Lt. Blue	1.125 (28.6)	100ft. (30.5m)	1 Roll (cont.)	76741
Fig.33	76609	B-569	Lt. Blue	0.500 (12.7)	100ft. (30.5m)	1 Roll (cont.)	76741
Fig.33	97738	B-569	Ochre	4.000 (101.6)	100ft. (30.5m)	1 Roll (cont.)	76739
Fig.33	97739	B-569	Ochre	2.250 (57.5)	100ft. (30.5m)	1 Roll (cont.)	76739
Fig.33	97740	B-569	Ochre	1.125 (28.6)	100ft. (30.5m)	1 Roll (cont.)	76739
Fig.33	97741	B-569	Ochre	0.500 (12.7)	100ft. (30.5m)	1 Roll (cont.)	76739
Fig.33	97742	B-569	Sky Blue	4.000 (101.6)	100ft. (30.5m)	1 Roll (cont.)	76739
Fig.33	97743	B-569	Sky Blue	2.250 (57.5)	100ft. (30.5m)	1 Roll (cont.)	76739
Fig.33	97744	B-569	Sky Blue	1.125 (28.6)	100ft. (30.5m)	1 Roll (cont.)	76739
Fig.33	97745	B-569	Sky Blue	0.500 (12.7)	100ft. (30.5m)	1 Roll (cont.)	76739
Fig.33	76610	B-569	Clear	4.000 (101.6)	100ft. (30.5m)	1 Roll (cont.)	76739
Fig.33	76611	B-569	Clear	2.250 (57.5)	100ft. (30.5m)	1 Roll (cont.)	76739
Fig.33	76612	B-569	Clear	1.125 (28.6)	100ft. (30.5m)	1 Roll (cont.)	76739
Fig.33	76613	B-569	Clear	0.500 (12.7)	100ft. (30.5m)	1 Roll (cont.)	76739

View all GlobalMark® Print Ribbon parts on page 389.



# GlobalMark®2 Label Materials

BradyID.com/globalmark

## Pre-Printed Pre-Cut Blank Sign Headers (B-595)

For creating Arc Flash and safety warning labels in seconds.

- Allows printer to create multicolor signs fast - in a single print pass
- Headers meet NFPA 70E, OSHA 1910.145 and ASME/ANSI Z535 standards
- Indoor/outdoor grade material conforms to rough, highly textured, and "difficult to adhere to" surfaces

Service temp: -40°F to 180°F Application temp: 0°F to 180°F  
Average Outdoor Durability: 8-10 years

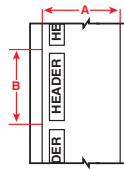

Figure 73



Print your own valve tag!  
View page 400 for blank rigid valve tags!

**NOTE:** A free firmware upgrade to version 25i for your GlobalMark® Label Maker is required to print these supplies. Contact Brady Technical Support at 1-800-643-8766 to upgrade.

Diagram	Catalog #	B#	Header	Label Height A Inch (mm)	Label Width B Inch (mm)	Labels Per Row	Labels Per Roll	Rec. Ribbon
Fig. 73	121550	B-595		2.250 (57.5)	3.250 (82.6)	1	270	76739
Fig. 73	121558	B-595		4.000 (101.6)	6.250 (158.8)	1	165	76739
Fig. 73	121552	B-595		2.250 (57.5)	3.250 (82.6)	1	270	76739
Fig. 73	121560	B-595		4.000 (101.6)	6.250 (158.8)	1	165	76739
Fig. 73	121551	B-595		2.250 (57.5)	3.250 (82.6)	1	270	76739
Fig. 73	121559	B-595		4.000 (101.6)	6.250 (158.8)	1	165	76739
Fig. 73	121549	B-595		2.250 (57.5)	3.250 (82.6)	1	270	76739
Fig. 73	121557	B-595		4.000 (101.6)	6.250 (158.8)	1	165	76739
Fig. 73	121553	B-595		2.250 (57.5)	3.250 (82.6)	1	270	76739
Fig. 73	121561	B-595		4.000 (101.6)	6.250 (158.8)	1	165	76739
Fig. 73	121554	B-595		2.250 (57.5)	3.250 (82.6)	1	270	76739
Fig. 73	121562	B-595		4.000 (101.6)	6.250 (158.8)	1	165	76739
Fig. 73	121563	B-595		1.125 (28.6) *	2.750 (69.8)	1	300	76739
Fig. 73	121547	B-595		2.250 (57.5)	3.250 (82.6)	1	270	76739
Fig. 73	121564	B-595		2.250 (57.5) *	3.750 (95.2)	1	250	76739
Fig. 73	121555	B-595		4.000 (101.6)	6.250 (158.8)	1	165	76739
Fig. 73	121548	B-595		2.250 (57.5)	3.250 (82.6)	1	270	76739
Fig. 73	121556	B-595		4.000 (101.6)	6.250 (158.8)	1	165	76739

\*Pre-sized to fit blank rigid valve tags (page 400) but can also be used on its own as general purpose label. Visit BradyID.com for information on Valve Tag Kit (catalog #142133).

## Non-Adhesive Pre-Printed & Pre-Cut Safety Tags (B-551)

Pre-printed and pre-cut to save you time!

- Non-adhesive semi rigid card stock
- Tags are pre-cut with hole and chamfered corners
- Perforated between tags
- Snap-in plastic grommets available for extra strength around mounting hole

Service temp: -40°F to 180°F Application temp: 0°F to 180°F  
Average Outdoor Durability: 8-10 years

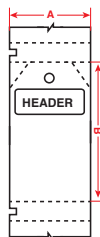

Figure 69



Diagram	Catalog #	B#	Header	Tag Width A Inch (mm)	Tag Height B Inch (mm)	Tags Per Row	Tags Per Roll	Rec. Ribbon
Fig. 69	121543	B-551		3.250 (82.6)	5.750 (146.1)	1	100	76739
Fig. 69	121544	B-551		3.250 (82.6)	5.750 (146.1)	1	100	76739
Fig. 69	121545	B-551		3.250 (82.6)	5.750 (146.1)	1	100	76739
Fig. 69	121546	B-551		3.250 (82.6)	5.750 (146.1)	1	100	76739

**NOTE:** A free firmware upgrade to version 25i for your GlobalMark® Label Maker is required to print these supplies. Contact Brady Technical Support at 1-800-643-8766 to upgrade.

View all GlobalMark® Print Ribbon parts on page 389.



## Make GHS / CLP Chemical Labels with your GlobalMark® Label Maker and MarkWare™ v3.9.1 Software.

- Create GHS labels by using your current blank white B-595 labels and a black/red panel ribbon - all you need is MarkWare v3.9.1 or higher software (*See page 405 for more details on the GHS / CLP module in MarkWare and how current MarkWare owners can upgrade for free*)
- Printer produces 2-color GHS label in 2 print passes
- Indoor/outdoor vinyl material withstands exposure to moisture, chemicals and handling



White B-595 Label Material



Black/Red Paneled GlobalMark® Ribbon (Catalog# 76763)



MarkWare™ v3.9.1 Software



Service temp: -4°F to 180°F  
Application temp: 50°F to 180°F  
Average Outdoor Durability: 3-5 years

### White B-595 Label Materials for GHS Label Printing

Diagram	Catalog #	B#	Color	Label Width Inch (mm)	Roll Length Feet (m)	Labels Per Roll*	For Use With
Fig. 73	113111	B-595	White	2.250 (57.5)	100ft (30.5 m)	approx 185	Small GHS template size in MarkWare
Fig. 73	113110	B-595	White	3.000 (76.2)	100ft (30.5 m)	approx 255	Medium GHS template size in MarkWare
Fig. 73	113109	B-595	White	4.000 (101.6)	100ft (30.5 m)	approx 340	Large GHS template size in MarkWare

\* Quantity per roll assumes given template size is used.

### Black/Red Paneled Ribbon Required for GHS Label Printing

Catalog #	Color	Size Inch (mm)	Length	Typical yield	For Use With
76763	Black & Red	4.110 (104.4) x 8.000 (203.2) Panels	200 ft. (60.9 m)	One hundred labels from 8" paneled ribbon	All GHS template sizes in MarkWare

## Right-to-Know Pre-Print Labels (B-595)

- Outdoor grade vinyl adhesive label in Color Bar or NFPA 704M diamond formats
- 4 color diamond or bars are pre-printed so these only require 1-color print pass (black) through printer

### Special Black Ribbon Required

The RTK Labels below require the use of the following black ribbon:

Catalog #	Description
96089	4.11" x 200' RTK Black Ribbon



Catalog #	B#	Legend	Label Width Inch (mm)	Label Height Inch (mm)	Labels Per Row	Labels Per Pkg	Rec. Ribbon
115763	B-595	Diamond + Text	4.000 (101.6)	6.250 (158.8)	1	170	96089
115766	B-595	Diamond + Text	2.250 (57.5)	4.000 (101.6)	1	240	96089
115772	B-595	Diamond + Text	2.250 (57.5)	2.250 (57.5)	1	365	96089
115765	B-595	Diamond Only	4.000 (101.6)	4.000 (101.6)	1	240	96089
115773	B-595	Diamond Only	2.250 (57.5)	2.250 (57.5)	1	365	96089
115764	B-595	Color Bar + Text	4.000 (101.6)	6.250 (158.8)	1	170	96089, 76739
115767	B-595	Color Bar + Text	2.250 (57.5)	4.000 (101.6)	1	240	96089, 76739
115771	B-595	Color Bar + Text	2.250 (57.5)	2.250 (57.5)	1	365	96089, 76739
115768	B-595	Color Bar Only	2.250 (57.5)	2.250 (57.5)	1	365	96089, 76739
115770	B-595	Color Bar HMIG	1.125 (28.6)	3.000 (76.2)	1	300	96089, 76739
115769	B-595	Diamond NFR	1.125 (28.6)	3.000 (76.2)	1	300	96089, 76739

## Hand-Applied Overlam for RTK Labels (B-674)

- Protect your printed labels with a pressure sensitive polyester overlamin.

Catalog #	B#	Color	Label Width Inch (mm)	Label Height Inch (mm)	Labels Per Pkg
64984	B-674	Clear Overlam	1.500 (38.1)	2.500 (63.5)	50
58476	B-674	Clear Overlam	2.500 (63.5)	2.500 (63.5)	50
58706	B-674	Clear Overlam	3.500 (88.9)	5.500 (139.7)	50
64985	B-674	Clear Overlam	4.500 (114.3)	6.500 (165.1)	50

View all GlobalMark® Print Ribbon parts on page 389.



# GlobalMark®2 Label Materials

BradyID.com/globalmark

## ToughStripe® Print-On-Demand Floor Labels (B-514)

- Revolutionary new B-514 material has ultra aggressive adhesive
- Withstands forklift and pallet jack traffic without tearing or lifting
- Easy 3-step process: print label, position on floor, apply overlaminates
- Each roll ships with a roll of clear overlaminate which must be applied over printed label and onto appropriate surface for best performance
- Plotter-cutting shapes and text not allowed with this material



Figure 33



Diagram	Catalog #	B#	Color	Label Width A Inch (mm)	Roll Length B Feet (m)	Labels Per Roll	Rec. Ribbon
Fig. 33	142155	B-514	White	1.125 (28.6)	100ft. (30.5m)	1 Roll (cont.)	76739
Fig. 33	142154	B-514	White	2.250 (57.5)	100ft. (30.5m)	1 Roll (cont.)	76739
Fig. 33	142156	B-514	White	3.000 (76.2)	100ft. (30.5m)	1 Roll (cont.)	76739
Fig. 33	142157	B-514	White	4.000 (101.6)	100ft. (30.5m)	1 Roll (cont.)	76739
Fig. 33	142162	B-514	Yellow	1.125 (28.6)	100ft. (30.5m)	1 Roll (cont.)	76739
Fig. 33	142161	B-514	Yellow	2.250 (57.5)	100ft. (30.5m)	1 Roll (cont.)	76739
Fig. 33	142163	B-514	Yellow	3.000 (76.2)	100ft. (30.5m)	1 Roll (cont.)	76739
Fig. 33	142164	B-514	Yellow	4.000 (101.6)	100ft. (30.5m)	1 Roll (cont.)	76741
Fig. 33	142166	B-514	Red	1.125 (28.6)	100ft. (30.5m)	1 Roll (cont.)	76741
Fig. 33	142165	B-514	Red	2.250 (57.5)	100ft. (30.5m)	1 Roll (cont.)	76741
Fig. 33	142167	B-514	Red	4.000 (101.6)	100ft. (30.5m)	1 Roll (cont.)	76741
Fig. 33	142169	B-514	Blue	1.125 (28.6)	100ft. (30.5m)	1 Roll (cont.)	76741
Fig. 33	142168	B-514	Blue	2.250 (57.5)	100ft. (30.5m)	1 Roll (cont.)	76741
Fig. 33	142170	B-514	Blue	4.000 (101.6)	100ft. (30.5m)	1 Roll (cont.)	76741
Fig. 33	142172	B-514	Green	1.125 (28.6)	100ft. (30.5m)	1 Roll (cont.)	76739
Fig. 33	142171	B-514	Green	2.250 (57.5)	100ft. (30.5m)	1 Roll (cont.)	76739
Fig. 33	142173	B-514	Green	4.000 (101.6)	100ft. (30.5m)	1 Roll (cont.)	76739
Fig. 33	142159	B-514	Black	1.125 (28.6)	100ft. (30.5m)	1 Roll (cont.)	76741
Fig. 33	142158	B-514	Black	2.250 (57.5)	100ft. (30.5m)	1 Roll (cont.)	76741
Fig. 33	142160	B-514	Black	4.000 (101.6)	100ft. (30.5m)	1 Roll (cont.)	76741
Fig. 33	142175	B-514	Orange	1.125 (28.6)	100ft. (30.5m)	1 Roll (cont.)	76739
Fig. 33	142174	B-514	Orange	2.250 (57.5)	100ft. (30.5m)	1 Roll (cont.)	76739
Fig. 33	142176	B-514	Orange	4.000 (101.6)	100ft. (30.5m)	1 Roll (cont.)	76739

## Phosphorescent Tape (B-526)

- Permanent adhesive and glows in darkness for 10 hours
- Glows brighter and longer than B-582
- Complies with indoor use requirements specified in RS 6-1 and 6-1A of New York Local Law 26
- Plotter-cutting shapes and text not allowed with this material



Figure 33



Diagram	Catalog #	B#	Color	Label Width A Inch (mm)	Roll Length B Feet (m)	Labels Per Roll	Rec. Ribbon
Fig. 33	105909	B-526	Phos. green background	4.000 (101.6)	50ft. (15.2m)	1 Roll (cont.)	76739, 76743
Fig. 33	105910	B-526	Phos. green background	2.500 (63.5)	50ft. (15.2m)	1 Roll (cont.)	76739, 76743
Fig. 33	105911	B-526	Phos. green background	1.375 (34.9)	50ft. (15.2m)	1 Roll (cont.)	76739, 76743

## Phosphorescent Tape (B-582)

- Permanent adhesive and glows in darkness for hours
- Meets ISO, & ASTM standards
- Plotter-cutting shapes and text not allowed with this material



Figure 33



Diagram	Catalog #	B#	Color	Label Width A Inch (mm)	Roll Length B Feet (m)	Labels Per Roll	Rec. Ribbon
Fig. 33	76711	B-582	Phos. green background	4.000 (101.6)	50ft. (15.2m)	1 Roll (cont.)	76739, 76743
Fig. 33	76712	B-582	Phos. green background	2.500 (63.5)	50ft. (15.2m)	1 Roll (cont.)	76739, 76743
Fig. 33	76713	B-582	Phos. green background	1.375 (34.9)	50ft. (15.2m)	1 Roll (cont.)	76739, 76743

View all GlobalMark® Print Ribbon parts on page 389.

## ToughWash™ Tape (B-854, B-855)

- Withstands pressures of high heat, harsh chemicals and numerous washdown cycles
- B-854 offers metal detectable layer to detect foreign debris in food stream
- Legible and long-lasting for even the toughest washdown cycles
- Ideal for use in the Food & Beverage industry
- Plotter-cutting shapes and text not allowed with this material

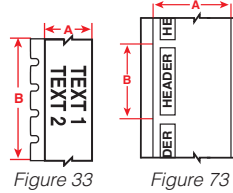

Diagram	Catalog #	B#	Legend	Label Width A Inch (mm)	Length B Inch (mm)	Labels Per Roll	Rec. Ribbon
<b>B-854 ToughWash™ Metal Detectable Material</b>							
Fig. 33	133134	B-854		4.000 (101.06)	50ft. (15.2 m)	1 roll (cont.)	134352
Fig. 33	133133	B-854		4.000 (101.06)	50ft. (15.2 m)	1 roll (cont.)	134352
Fig. 73	133141	B-854		4.000 (101.06)	6.250 (158.8)	100	134352
Fig. 73	133140	B-854		4.000 (101.06)	6.250 (158.8)	100	134352
Fig. 73	133139	B-854		4.000 (101.06)	6.250 (158.8)	100	134352
<b>B-855 ToughWash™ Material</b>							
Fig. 33	133159	B-855		4.000 (101.06)	50ft. (15.2 m)	1 roll (cont.)	134352
Fig. 33	133158	B-855		4.000 (101.06)	50ft. (15.2 m)	1 roll (cont.)	134352
Fig. 73	133166	B-855		4.000 (101.06)	6.250 (158.8)	100	134352
Fig. 73	133165	B-855		4.000 (101.06)	6.250 (158.8)	100	134352
Fig. 73	133164	B-855		4.000 (101.06)	6.250 (158.8)	100	134352

## Reflective Tape (B-584)

- Permanent adhesive/outdoor grade
- Shines back at viewer brightly when light shines on label
- Plotter-cutting shapes and text not allowed with this material

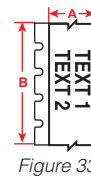

Diagram	Catalog #	B#	Color	Label Width A Inch (mm)	Roll Length B Feet (m)	Labels Per Roll	Rec. Ribbon
Fig. 33	76705	B-584	Silver	4.000 (101.6)	50ft. (15.2m)	1 Roll (cont.)	76739
Fig. 33	76706	B-584	Silver	2.250 (57.5)	50ft. (15.2m)	1 Roll (cont.)	76739
Fig. 33	76707	B-584	Silver	1.375 (34.9)	50ft. (15.2m)	1 Roll (cont.)	76739
Fig. 33	96060	B-584	Yellow	4.000 (101.6)	50ft. (15.2m)	1 Roll (cont.)	76739
Fig. 33	96061	B-584	Yellow	2.250 (57.5)	50ft. (15.2m)	1 Roll (cont.)	76739
Fig. 33	96062	B-584	Yellow	1.375 (34.9)	50ft. (15.2m)	1 Roll (cont.)	76739
Fig. 33	99219	B-584	Orange	4.000 (101.6)	50ft. (15.2m)	1 Roll (cont.)	76739
Fig. 33	99220	B-584	Orange	2.250 (57.5)	50ft. (15.2m)	1 Roll (cont.)	76739
Fig. 33	99221	B-584	Orange	1.375 (34.9)	50ft. (15.2m)	1 Roll (cont.)	76739

## Tag Stock Material (B-551)

- Non-adhesive tag stock meets OSHA 50 lb. pull requirement
- May we also suggest: Grommets (Catalog # 20596) or 5/8" Hole punch (Catalog # 20591)
- Plotter-cutting shapes and text not allowed with this material



Diagram	Catalog #	B#	Color	Label Width A Inch (mm)	Roll Length B Feet (m)	Labels Per Roll	Rec. Ribbon
Fig. 33	76714	B-551	White	4.250 (107.9)	50ft. (15.2m)	1 Roll (cont.)	76739
Fig. 33	76715	B-551	White	3.250 (82.5)	50ft. (15.2m)	1 Roll (cont.)	76739
Fig. 33	76716	B-551	White	2.500 (63.5)	50ft. (15.2m)	1 Roll (cont.)	76739

View all GlobalMark® Print Ribbon parts on page 389.



# GlobalMark®2 Label Materials

BradyID.com/globalmark

## Repositionable Vinyl Tape (B-581)

- Special adhesive allows you to easily remove the label and re-apply
- Ideal for indoor marking where frequent repositioning is required
- Plotter-cutting shapes and text not allowed with this material

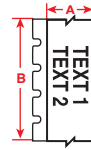

Figure 33



Diagram	Catalog #	B#	Color	Label Width A Inch (mm)	Roll Length B Feet (m)	Labels Per Roll	Rec. Ribbon
Fig. 33	76697	B-581	White	4.000 (101.6)	100ft. (30.5m)	1 Roll (cont.)	76739
Fig. 33	76698	B-581	White	2.250 (57.5)	100ft. (30.5m)	1 Roll (cont.)	76739
Fig. 33	76699	B-581	White	1.125 (28.6)	100ft. (30.5m)	1 Roll (cont.)	76739
Fig. 33	76700	B-581	White	0.500 (12.7)	100ft. (30.5m)	1 Roll (cont.)	76739
Fig. 33	76701	B-581	Yellow	4.000 (101.6)	100ft. (30.5m)	1 Roll (cont.)	76739
Fig. 33	76702	B-581	Yellow	2.250 (57.5)	100ft. (30.5m)	1 Roll (cont.)	76739
Fig. 33	76703	B-581	Yellow	1.125 (28.6)	100ft. (30.5m)	1 Roll (cont.)	76739
Fig. 33	76704	B-581	Yellow	0.500 (12.7)	100ft. (30.5m)	1 Roll (cont.)	76739

## Magnetic Tape (B-509)

- Non-adhesive
- Print direct onto magnetic tape
- Plotter-cutting shapes and text not allowed with this material

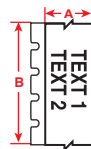

Figure 33



Diagram	Catalog #	B#	Color	Label Width A Inch (mm)	Roll Length B Feet (m)	Labels Per Roll	Rec. Ribbon
Fig. 33	76686	B-509	White	4.000 (101.6)	25ft (7.62m)	1 Roll (cont.)	76739
Fig. 33	76687	B-509	White	2.500 (63.5)	25ft (7.62m)	1 Roll (cont.)	76739
Fig. 33	76688	B-509	Yellow	4.000 (101.6)	25ft (7.62m)	1 Roll (cont.)	76739
Fig. 33	76689	B-509	Yellow	2.500 (63.5)	25ft (7.62m)	1 Roll (cont.)	76739

## Cold Temperature Tape (B-549)

- Permanently adheres to surfaces at temperatures as low as -10°F
- Great for use in any cold storage warehouse, cooler or freezer
- Plotter-cutting shapes and text not allowed with this material

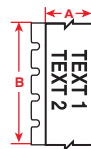

Figure 33



Diagram	Catalog #	B#	Color	Label Width A Inch (mm)	Roll Length B Feet (m)	Labels Per Roll	Rec. Ribbon
Fig. 33	76691	B-549	White	4.250 (107.9)	100ft. (30.5m)	1 Roll (cont.)	76739
Fig. 33	76692	B-549	White	2.500 (63.5)	100ft. (30.5m)	1 Roll (cont.)	76739
Fig. 33	76693	B-549	White	1.375 (34.9)	100ft. (30.5m)	1 Roll (cont.)	76739
Fig. 33	76694	B-549	Yellow	4.000 (101.6)	100ft. (30.5m)	1 Roll (cont.)	76739
Fig. 33	76695	B-549	Yellow	2.500 (63.5)	100ft. (30.5m)	1 Roll (cont.)	76739
Fig. 33	76696	B-549	Yellow	1.375 (34.9)	100ft. (30.5m)	1 Roll (cont.)	76739

## Metallized Polyester Tape (B-565)

- Permanent adhesive
- Non-cutttable supply suitable for continuous-style labels
- Cuttable supply ideal for multi-up, cut labels in basic rectangular & round shapes only. Not suitable for cut-out text or intricate shapes.



Figure 33



Diagram	Catalog #	B#	Color	Label Width A Inch (mm)	Roll Length B Feet (m)	Labels Per Roll	Rec. Ribbon
Fig. 33	76720	B-565	Non-cutttable Metallized	4.250 (107.9)	100ft. (30.5m)	1 Roll (cont.)	76739
Fig. 33	76721	B-565	Non-cutttable Metallized	2.500 (63.5)	100ft. (30.5m)	1 Roll (cont.)	76739
Fig. 33	76722	B-565	Non-cutttable Metallized	1.375 (34.9)	100ft. (30.5m)	1 Roll (cont.)	76739
Fig. 33	114533	B-565	Cutttable Metallized	4.250 (107.9)	100ft. (30.5m)	1 Roll (cont.)	76739

## Transfer Tape For Cut Text

- Leaves cut characters pre-spaced for transferring from liner to applying them to desired surface

Diagram	Catalog #	Label Width A Inch (mm)	Roll Length B Feet (m)
Fig. 33	76737	4.250 (107.9)	200ft. (60.9m)

View all GlobalMark® Print Ribbon parts on page 389.

## GlobalMark®2 Industrial Print Ribbons

“Drop & Click” print ribbons for quick and easy supply changes.

- Super-Tough smear-proof ribbons assure your printed text lasts for years outdoors and in an industrial environment
- Ribbons ship self-contained in cartridges that drop straight in to the GlobalMark® with a “click”
- No calibrating, no threading, no wasted feeding, no hassles, and the ink will always be facing the right direction!
- 2 and 4-color “paneled” ribbons are used to print labels and signs containing more than 1 print color
- Patent D481,755



Example of a Single Color Ribbon

Examples of Multi-Color Paneled Ribbons

### Single Color Print Ribbons

Catalog #	Color	Size Inch (mm)	Length
76739	Black	4.110 (104.4)	200 ft. (60.9 m)
134352	Black (for use with B-854 & B-855 ToughWash™ material only)	4.110 (104.4)	200 ft. (60.9 m)
96089	Black (for use with RTK labels)	4.110 (104.4)	200 ft. (60.9 m)
76741	White	4.110 (104.4)	200 ft. (60.9 m)
76743	Red	4.110 (104.4)	200 ft. (60.9 m)
76745	Blue	4.110 (104.4)	200 ft. (60.9 m)
76747	Green	4.110 (104.4)	200 ft. (60.9 m)
76749	Magenta	4.110 (104.4)	200 ft. (60.9 m)
76751	Yellow	4.110 (104.4)	200 ft. (60.9 m)
76752	Orange	4.110 (104.4)	200 ft. (60.9 m)
76759	Process Cyan	4.110 (104.4)	200 ft. (60.9 m)
76760	Process Yellow	4.110 (104.4)	200 ft. (60.9 m)
76761	Process Magenta	4.110 (104.4)	200 ft. (60.9 m)

### Two Color Print Ribbons

Catalog #	Color	Size Inch (mm)	Length
<b>4.110 (104.4) x 8.000 (203.2) Panels</b>			
Typical yield: One hundred 8" labels from 8" paneled ribbon			
76739	Black	4.110 (104.4) x 8.000 (203.2) Panels	200 ft. (60.9 m)
76763	Black & Red	4.110 (104.4) x 8.000 (203.2) Panels	200 ft. (60.9 m)
110220	Red & Green	4.110 (104.4) x 8.000 (203.2) Panels	200 ft. (60.9 m)
76775	Black & Blue	4.110 (104.4) x 8.000 (203.2) Panels	200 ft. (60.9 m)
76767	Black & Yellow	4.110 (104.4) x 8.000 (203.2) Panels	200 ft. (60.9 m)
76771	Black & Orange	4.110 (104.4) x 8.000 (203.2) Panels	200 ft. (60.9 m)
76779	Black & Green	4.110 (104.4) x 8.000 (203.2) Panels	200 ft. (60.9 m)
<b>4.110 (104.4) x 16.000 (406.4) Panels</b>			
Typical yield: Sixty 16" labels from 16" paneled ribbon			
76762	Black & Red	4.110 (104.4) x 16.000 (406.4) Panels	200 ft. (60.9 m)
76774	Black & Blue	4.110 (104.4) x 16.000 (406.4) Panels	200 ft. (60.9 m)
76766	Black & Yellow	4.110 (104.4) x 16.000 (406.4) Panels	200 ft. (60.9 m)
76770	Black & Orange	4.110 (104.4) x 16.000 (406.4) Panels	200 ft. (60.9 m)
76778	Black & Green	4.110 (104.4) x 16.000 (406.4) Panels	200 ft. (60.9 m)
76782	Red & Blue	4.110 (104.4) x 16.000 (406.4) Panels	200 ft. (60.9 m)

### Four Color Print Ribbons

Catalog #	Color	Size Inch (mm)	Length
<b>4.110 (104.4) x 8.000 (203.2) Panels</b>			
Typical yield: Fifty 8" labels from 8" paneled ribbon			
76787	Black, Red, Blue & Green	4.110 (104.4) x 8.000 (203.2) Panels	200 ft. (60.9 m)
110221	Red, Green, Yellow & Black	4.110 (104.4) x 8.000 (203.2) Panels	200 ft. (60.9 m)
76791	Black, Red, Blue & Yellow	4.110 (104.4) x 8.000 (203.2) Panels	200 ft. (60.9 m)
76795	Cyan, Magenta, Yellow & Black	4.110 (104.4) x 8.000 (203.2) Panels	200 ft. (60.9 m)
51447	Black, Red, Orange & Blue	4.110 (104.4) x 8.000 (203.2) Panels	200 ft. (60.9 m)
<b>4.110 (104.4) x 16.000 (406.4) Panels</b>			
Typical yield: Thirty 16" labels from 16" paneled ribbon			
76786	Black, Red, Blue & Green	4.110 (104.4) x 16.000 (406.4) Panels	200 ft. (60.9 m)
76790	Black, Red, Blue & Yellow	4.110 (104.4) x 16.000 (406.4) Panels	200 ft. (60.9 m)
76794	Cyan, Magenta, Yellow & Black	4.110 (104.4) x 16.000 (406.4) Panels	200 ft. (60.9 m)



# BBP®85 Sign and Label Printer

BradyID.com/bbp85

Benchtop Printers



BRADY 360  
**5 YEAR**  
WARRANTY



### View Online!

Visit [BradyID.com/BBP85](http://BradyID.com/BBP85) for more information on the BBP®85 Sign and Label Printer.

### Your Complete Printing Solution:

BBP®85 Label Materials .....Page 392  
BBP®85 Print Ribbons .....Page 396

### Best-of-the-Best Materials.

Brady's sign and label materials lead the industry in durability and performance. They withstand harsh conditions, stay stuck on the most challenging surfaces and they simply last longer than other materials on the market. With the BBP85 printer, you can choose from over one hundred supply options, including:

- Huge selection of 4" wide to 10" wide industrial grade outdoor materials
- Specialty materials including Reflective and Glow-in-the-Dark
- Pre-printed sign header supplies for GHS, arc flash and OSHA or ANSI safety signs, which means only one print pass!

## BBP®85 LABEL PRINTER

There's **BIG** and **BOLD**.

Then there's **BIG** and **BOLD** from Brady.

The BBP®85 Label Printer allows you to create 10" labels in multiple colors, and it has an easier-than-ever interface that anyone on your team can use! No more complex, tedious design steps. Now you can just walk up and print... anyone can do it!

### Big Output. Little Fuss.

Create extra-large 10" custom signs and labels right now! This printer has our fastest, easiest operating system, so anyone on your team can design visuals with little to no training. The ideal printer for multi-user Lean 5S and kaizen labeling events!

- Unmistakably large visuals up to 10" wide
- Just walk up and print...it really is that easy!
- Simple touch-screen interface for stand-alone use, or print from your PC with MarkWare™ Software
- Timesaving label design apps to create pipe markers, safety signs, arc flash, right-to-know labels, and more!
- USB port for importing files, fonts and graphics



### Create Custom Rigid Signs

Pair the BBP®85 Printer with Brady's BLS1255 Laminating System to create custom rigid signs in minutes.

View page 400 for available blank rigid sign panels.

### Big, bold and better than ever.



Larger Signs (up to 10")



Custom Signs On Demand



Equipment I.D.



Low Light Applications



GHS Hazcomm



Pipe Markers

# BBP®85 Sign and Label Printer

BradyID.com/bbp85

## PowerMark® Printer Specifications

<b>Description</b>	Large 10" format multi-color facility ID printer with ultimate walk-up-and-print ease for use and no calibration set-up, no label waste and 20 second supply changeovers. Revolutionary ease of use makes it ideal for training multiple users and saving wasted time and wasted label cost.
<b>Applications &amp; Comments</b>	Large-sized labels up to 10" for signs, warnings, lean/5S, arc flash, GHS chemical labels, equipment & panel labels, roll form pipe markets, reflective and glow-in-the-dark labels
<b>Label Material Types</b>	Extremely aggressive 8-10 year outdoor vinyl with high tack and chemical resistance, plus reflective, 10-hour glow-in-the-dark and polyester.
<b>Types of labels available</b>	Continuous material and pre-printed die cut labels
<b>Print Technology</b>	Thermal Transfer
<b>Print Resolution</b>	300 dpi
<b>Max Print Width</b>	10.000"
<b>Media Widths</b>	4.000" to 10.000"
<b>Minimum Label Dimension</b>	4.000"
<b>Color Printing Capabilities</b>	Multiple print colors on a label (some pre-printed multicolor supplies also available)
<b>Auto Cut-off</b>	Yes
<b>X-Y Plotter Cutting (cutting out shapes &amp; text)</b>	No
<b>PC Connect or Stand Alone Operation</b>	PC Connect and Stand Alone
<b>Ribbon &amp; label roll installation</b>	<b>Labels:</b> Supplied in cartridge, 15 sec changeover <b>Ribbon:</b> Supplied on geared snap-in rolls, 5 sec changeover
<b>Calibration Required?</b>	No (no waste)
<b>Label creation &amp; set-up</b>	Automatic (printer or PC reads data on chip and automatically sets up label size, color, fonts, etc.)
<b>Connectivity Options</b>	Standard: USB, Ethernet Optional: WiFi, WiFi Direct
<b>Compatible Software</b>	Brady Workstation Apps, MarkWare™ Software, Windows® based driver for 3rd party software use*
<b>Warranty</b>	5 years

\* Patent No. 8,542,155; 8,783,983.  
Additional Patents Pending

## BBP®85 Label Printer and Accessories

Catalog #	Description
BBP85	BBP85 Sign & Label Printer*
BBP85-MWL	BBP85 Sign & Label Printer* with Markware Lean Software
BBP85-31-71-Kit	BBP85 Sign & Label Printer*, BBP31 Printer, BMP71 Printer & Markware Lean Software
BBP85-31-Kit	BBP85 Sign & Label Printer*, BBP31 Printer & Markware Lean Software
BBP85-71-Kit	BBP85 Sign & Label Printer*, BMP71 Printer & Markware Lean Software
B85-DC	BBP85 Printer Dust Cover
STYLUS-3PK	Replacement Stylus Pens 3pk

\* BBP®85 printer ships with documentation CD, printer driver CD, power cord, USB cord, quick start guide, cleaning kit.



**BBP®31 Sign & Label Printer**  
View page 352.



**BMP®71 Label Printer**  
View page 324.

## BBP®85 PC-Connect Software Solutions:



### Brady Workstation Apps

Brady has revolutionized its label creation software by now offering apps specific to your projects. Once the free Brady Workstation is installed on your PC, you can then download a variety of free or paid labeling apps including Custom Label Designer, Express Signs, Pipe Markers, Lockout Writer and GHS. View page 404 or download at [workstation.bradyid.com](http://workstation.bradyid.com)



### MarkWare™ Facility Identification Software

CD-based software option for creating custom safety signs & labels including pipe markers, ANSI signs, lockout tags, GHS labels, RTK chemical labels, lean 5S visuals and custom labels with barcodes and graphics. Built-in graphics and 2,000 chemical database for RTK. Pre-formatted GHS label templates. View page 405 for more information.

## Brady360® 5 Year Warranty

We have you Covered.



We always stand behind our products to make sure they deliver you an unrivaled customer experience. We've strengthened our commitment to you with a **5-year printer warranty standard and free of charge** on our benchtop printer models.\* With a team of 30 certified tech support and repair technicians and our 5-year warranty backing you up, you can rest assured you'll have the support you need—every step of the way.

### Free 5-year warranty standard on Benchtop models\* covers:

- Repair parts & labor
- One print head replacement
- Free loaner printer during repairs
- Free return shipping after repair
- Free Brady 360® stress-free printer setup session
- Free lifetime technical support via phone and email
- Free lifetime firmware upgrades
- One free Brady 360® preventative maintenance service

### Access to additional fee-based support:

- On-site repair service
- On-site custom set-up and training
- Additional print head coverage (after the first free replacement)
- Advanced custom integration, programming support and template creation

\*Excludes repairs due to negligence. Excludes Wraptor™ model and handheld models. See [BradyID.com/brady360](http://BradyID.com/brady360) for full coverage details & restrictions.



### Did you know? PowerMark Materials

The BBP®85 Sign & Label Printer accepts many of the same materials that the PowerMark™ Label Maker uses. Simply look for "BBP85" or "A" on the supply roll's label to verify compatibility with both models. Questions? Call Brady Tech Support at 1-800-643-8766.

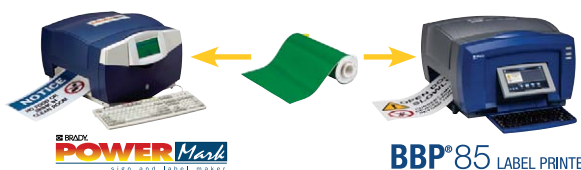

# BBP®85 Label Materials

BradyID.com/bbp85

## Indoor/Outdoor Grade Vinyl Tape (B-595)

For all-purpose facility and safety identification: our best industrial vinyl!

- Durable, low-shrink vinyl with our most aggressive adhesive and 8-10 year outdoor durability
- Conforms to irregular, curved, rough and highly textured surfaces (painted cinder blocks and wood, textured plastics, cast-iron and paper-jacketed pipes, powder-coated surfaces)

Service temp: -40°F to 180°F Application temp: 0°F to 180°F  
Average Outdoor Durability: 8-10 year outdoor vinyl label durability.



Benchtop Printers

Fits Printer Model(s)	Diagram	Catalog #	B#	Color	Label Width A Inch (mm)	Roll Length B Feet (m)	Labels Per Roll	Rec. Ribbon
BBP85, PMK	Fig. 33	13538	B-595	White	4.000 (101.6)	50ft. (15.2m)	1 roll (cont)	13511
BBP85, PMK	Fig. 33	13549	B-595	White	6.000 (152.4)	50ft. (15.2m)	1 roll (cont)	13511
BBP85, PMK	Fig. 33	13651	B-595	White	7.000 (177.8)	50ft. (15.2m)	1 roll (cont)	13510
BBP85, PMK	Fig. 33	13551	B-595	White	8.000 (203.2)	50ft. (15.2m)	1 roll (cont)	13510
BBP85, PMK	Fig. 33	13562	B-595	White	10.000 (254.0)	50ft. (15.2m)	1 roll (cont)	13510
BBP85, PMK	Fig. 33	13539	B-595	Yellow	4.000 (101.6)	50ft. (15.2m)	1 roll (cont)	13511
BBP85, PMK	Fig. 33	13550	B-595	Yellow	6.000 (152.4)	50ft. (15.2m)	1 roll (cont)	13511
BBP85, PMK	Fig. 33	13652	B-595	Yellow	7.000 (177.8)	50ft. (15.2m)	1 roll (cont)	13510
BBP85, PMK	Fig. 33	13552	B-595	Yellow	8.000 (203.2)	50ft. (15.2m)	1 roll (cont)	13510
BBP85, PMK	Fig. 33	13563	B-595	Yellow	10.000 (254.0)	50ft. (15.2m)	1 roll (cont)	13510
BBP85, PMK	Fig. 33	13540	B-595	Red	4.000 (101.6)	50ft. (15.2m)	1 roll (cont)	13513
BBP85, PMK	Fig. 33	13601	B-595	Red	6.000 (152.4)	50ft. (15.2m)	1 roll (cont)	13513
BBP85, PMK	Fig. 33	13654	B-595	Red	7.000 (177.8)	50ft. (15.2m)	1 roll (cont)	13512
BBP85, PMK	Fig. 33	13553	B-595	Red	8.000 (203.2)	50ft. (15.2m)	1 roll (cont)	13512
BBP85, PMK	Fig. 33	13610	B-595	Red	10.000 (254.0)	50ft. (15.2m)	1 roll (cont)	13512
BBP85, PMK	Fig. 33	13541	B-595	Blue	4.000 (101.6)	50ft. (15.2m)	1 roll (cont)	13513
BBP85, PMK	Fig. 33	13602	B-595	Blue	6.000 (152.4)	50ft. (15.2m)	1 roll (cont)	13513
BBP85, PMK	Fig. 33	13656	B-595	Blue	7.000 (177.8)	50ft. (15.2m)	1 roll (cont)	13512
BBP85, PMK	Fig. 33	13554	B-595	Blue	8.000 (203.2)	50ft. (15.2m)	1 roll (cont)	13512
BBP85, PMK	Fig. 33	13611	B-595	Blue	10.000 (254.0)	50ft. (15.2m)	1 roll (cont)	13512
BBP85, PMK	Fig. 33	13542	B-595	Green	4.000 (101.6)	50ft. (15.2m)	1 roll (cont)	13513
BBP85, PMK	Fig. 33	13603	B-595	Green	6.000 (152.4)	50ft. (15.2m)	1 roll (cont)	13513
BBP85, PMK	Fig. 33	13655	B-595	Green	7.000 (177.8)	50ft. (15.2m)	1 roll (cont)	13512
BBP85, PMK	Fig. 33	13555	B-595	Green	8.000 (203.2)	50ft. (15.2m)	1 roll (cont)	13512
BBP85, PMK	Fig. 33	13612	B-595	Green	10.000 (254.0)	50ft. (15.2m)	1 roll (cont)	13512
BBP85, PMK	Fig. 33	13543	B-595	Orange	4.000 (101.6)	50ft. (15.2m)	1 roll (cont)	13511
BBP85, PMK	Fig. 33	13604	B-595	Orange	6.000 (152.4)	50ft. (15.2m)	1 roll (cont)	13511
BBP85, PMK	Fig. 33	13653	B-595	Orange	7.000 (177.8)	50ft. (15.2m)	1 roll (cont)	13510
BBP85, PMK	Fig. 33	13556	B-595	Orange	8.000 (203.2)	50ft. (15.2m)	1 roll (cont)	13510
BBP85, PMK	Fig. 33	13613	B-595	Orange	10.000 (254.0)	50ft. (15.2m)	1 roll (cont)	13510
BBP85, PMK	Fig. 33	13544	B-595	Black	4.000 (101.6)	50ft. (15.2m)	1 roll (cont)	13513
BBP85, PMK	Fig. 33	13605	B-595	Black	6.000 (152.4)	50ft. (15.2m)	1 roll (cont)	13513
BBP85, PMK	Fig. 33	13557	B-595	Black	8.000 (203.2)	50ft. (15.2m)	1 roll (cont)	13512
BBP85, PMK	Fig. 33	13614	B-595	Black	10.000 (254.0)	50ft. (15.2m)	1 roll (cont)	13512
BBP85, PMK	Fig. 33	13545	B-595	Gold	4.000 (101.6)	50ft. (15.2m)	1 roll (cont)	13511
BBP85, PMK	Fig. 33	13606	B-595	Gold	6.000 (152.4)	50ft. (15.2m)	1 roll (cont)	13511
BBP85, PMK	Fig. 33	13558	B-595	Gold	8.000 (203.2)	50ft. (15.2m)	1 roll (cont)	13510
BBP85, PMK	Fig. 33	13615	B-595	Gold	10.000 (254.0)	50ft. (15.2m)	1 roll (cont)	13510
BBP85, PMK	Fig. 33	13546	B-595	Gray	4.000 (101.6)	50ft. (15.2m)	1 roll (cont)	13511
BBP85, PMK	Fig. 33	13607	B-595	Gray	6.000 (152.4)	50ft. (15.2m)	1 roll (cont)	13511
BBP85, PMK	Fig. 33	13559	B-595	Gray	8.000 (203.2)	50ft. (15.2m)	1 roll (cont)	13510
BBP85, PMK	Fig. 33	13616	B-595	Gray	10.000 (254.0)	50ft. (15.2m)	1 roll (cont)	13510
BBP85, PMK	Fig. 33	13547	B-595	Brown	4.000 (101.6)	50ft. (15.2m)	1 roll (cont)	13513
BBP85, PMK	Fig. 33	13608	B-595	Brown	6.000 (152.4)	50ft. (15.2m)	1 roll (cont)	13513
BBP85, PMK	Fig. 33	13560	B-595	Brown	8.000 (203.2)	50ft. (15.2m)	1 roll (cont)	13512
BBP85, PMK	Fig. 33	13617	B-595	Brown	10.000 (254.0)	50ft. (15.2m)	1 roll (cont)	13512
BBP85, PMK	Fig. 33	13548	B-595	Purple	4.000 (101.6)	50ft. (15.2m)	1 roll (cont)	13513
BBP85, PMK	Fig. 33	13609	B-595	Purple	6.000 (152.4)	50ft. (15.2m)	1 roll (cont)	13513
BBP85, PMK	Fig. 33	13561	B-595	Purple	8.000 (203.2)	50ft. (15.2m)	1 roll (cont)	13512
BBP85, PMK	Fig. 33	13618	B-595	Purple	10.000 (254.0)	50ft. (15.2m)	1 roll (cont)	13512
BBP85, PMK	Fig. 33	59529	B-595	Clear	4.000 (101.6)	50ft. (15.2m)	1 roll (cont)	13511
BBP85, PMK	Fig. 33	59530	B-595	Clear	6.000 (152.4)	50ft. (15.2m)	1 roll (cont)	13511
BBP85, PMK	Fig. 33	59531	B-595	Clear	8.000 (203.2)	50ft. (15.2m)	1 roll (cont)	13510
BBP85, PMK	Fig. 33	59532	B-595	Clear	10.000 (254.0)	50ft. (15.2m)	1 roll (cont)	13510

U.S. Patent Nos. 5,318,370; 5,823,689; 6,570,602. Additional Patents Pending.

View all BBP85 Print Ribbon parts on page 396.



## Pre-Printed Right-To-Know Chemical Labels (B-595)

For quickly creating NFPA and color bar labels.

- Blank die cut labels pre-printed with chemical diamonds and color bars
- Indoor/outdoor grade material withstands exposure to moisture, chemicals and handling
- Allows printer to produce 5-color chemical labels in a single print pass

Service temp: -40°F to 180°F Application temp: 0°F to 180°F  
Average Outdoor Durability: 8 to 10 years outdoor vinyl label durability



Fits Printer Model(s)	Catalog #	B#	Legend	Label Height Inch (mm)	Label Width Inch (mm)	Labels Per Row	Labels Per Roll	Rec. Ribbon
BBP85	130808	B-595	Diamond + Text	4.000 (101.6)	6.000 (152.4)	1	95	13511
BBP85	130809	B-595	Diamond + Text	7.000 (177.8)	10.000 (254.0)	1	60	13510
BBP85	130810	B-595	Diamond Only	6.000 (152.4)	6.000 (152.4)	1	95	13511
BBP85	130811	B-595	Color Bar + Text	4.000 (101.6)	6.000 (152.4)	1	95	13511
BBP85	130812	B-595	Color Bar + Text	7.000 (177.8)	10.000 (254.0)	1	60	13510

## Pre-Printed Pre-Cut Blank Sign Headers (B-595, B-7569)

For creating arc flash and safety warning labels in seconds.

- Faster way to design commonly used safety signs and labels
- Create custom, colorful safety labels using only a black ribbon
- Headers meet NFPA 70E, OSHA 1910.145 and ASME/ANSI Z535 standards
- Indoor/outdoor grade material conforms to rough, highly textured, and "difficult to adhere to" surfaces

Service temp: -40°F to 180°F Application temp: 0°F to 180°F  
Average Outdoor Durability: 8-10 years outdoor vinyl durability

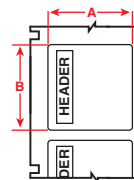

Figure 70



Fits Printer Model(s)	Diagram	Catalog #	B#	Header	Label Height A Inch (mm)	Label Width B Inch (mm)	Labels Per Roll	Rec. Ribbon
BBP85	Fig. 70	140886	B-7569		10.000 (254.0)	14.000 (355.6)	40	13510
BBP85	Fig. 70	130750	B-595		7.000 (177.8)	10.000 (254.0)	60	13510
BBP85	Fig. 70	130749	B-595		4.000 (101.6)	6.000 (152.4)	95	13511
BBP85	Fig. 70	140887	B-7569		10.000 (254.0)	14.000 (355.6)	40	13510
BBP85	Fig. 70	130753	B-595		7.000 (177.8)	10.000 (254.0)	60	13510
BBP85	Fig. 70	130752	B-595		4.000 (101.6)	6.000 (152.4)	95	13511
BBP85	Fig. 70	140888	B-7569		10.000 (254.0)	14.000 (355.6)	40	13510
BBP85	Fig. 70	130756	B-595		7.000 (177.8)	10.000 (254.0)	60	13510
BBP85	Fig. 70	130755	B-595		4.000 (101.6)	6.000 (152.4)	95	13511
BBP85	Fig. 70	140889	B-7569		10.000 (254.0)	14.000 (355.6)	40	13510
BBP85	Fig. 70	130759	B-595		7.000 (177.8)	10.000 (254.0)	60	13510
BBP85	Fig. 70	130758	B-595		4.000 (101.6)	6.000 (152.4)	95	13511
BBP85	Fig. 70	140885	B-7569		10.000 (254.0)	14.000 (355.6)	40	13510
BBP85	Fig. 70	130762	B-595		7.000 (177.8)	10.000 (254.0)	60	13510
BBP85	Fig. 70	130761	B-595		4.000 (101.6)	6.000 (152.4)	95	13511
BBP85	Fig. 70	140890	B-7569		10.000 (254.0)	14.000 (355.6)	40	13510
BBP85	Fig. 70	130765	B-595		7.000 (177.8)	10.000 (254.0)	60	13510
BBP85	Fig. 70	130764	B-595		4.000 (101.6)	6.000 (152.4)	95	13511
BBP85	Fig. 70	140883	B-7569		10.000 (254.0)	14.000 (355.6)	40	13510
BBP85	Fig. 70	132393	B-595		7.000 (177.8)	10.000 (254.0)	60	13510
BBP85	Fig. 70	140884	B-7569		10.000 (254.0)	14.000 (355.6)	40	13510
BBP85	Fig. 70	132395	B-595		7.000 (177.8)	10.000 (254.0)	60	13510



### Create Your Own Rigid Signs!

Pair Pre-Printed Pre-Cut Blank Sign Headers with rigid sign blanks to create custom rigid signs in minutes.

View **page 400** for available blank rigid sign panels.



View all BBP®85 Print Ribbon parts on page 396.



# BBP®85 Label Materials

BradyID.com/bbp85

## Pre-Printed GHS / CLP Chemical Labels (B-7569)

For GHS and hazard communication labeling.

- Blank labels with pre-printed red diamonds save time during label design
- 6 diamond layouts that match templates in Markware™ Software, available in 2 sizes each
- Indoor/outdoor vinyl material withstands exposure to moisture, chemicals and handling
- Markware™ Software v3.9.1 or higher required (free upgrade available for v3.x owners)

Service temp: -4°F to 180°F Application temp: 50°F to 180°F  
Average Outdoor Durability: 3-5 years



Fits Printer Model(s)	Catalog #	B#	Legend	Label Height Inch (mm)	Label Width Inch (mm)	Labels Per Row	Labels Per Roll	Rec. Ribbon
BBP85	130766	B-7569		4.100 (104.1)	6.100 (154.9)	1	90	13511
BBP85	130772	B-7569		6.100 (154.9)	8.300 (210.8)	1	70	13510
BBP85	130767	B-7569		4.100 (104.1)	6.100 (154.9)	1	90	13511
BBP85	130773	B-7569		6.100 (154.9)	8.300 (210.8)	1	70	13510
BBP85	130768	B-7569		4.100 (104.1)	6.100 (154.9)	1	90	13511
BBP85	130774	B-7569		6.100 (154.9)	8.300 (210.8)	1	70	13510
BBP85	130769	B-7569		4.100 (104.1)	6.100 (154.9)	1	90	13511
BBP85	130775	B-7569		6.100 (154.9)	8.300 (210.8)	1	70	13510
BBP85	130770	B-7569		4.100 (104.1)	6.100 (154.9)	1	90	13511
BBP85	130776	B-7569		6.100 (154.9)	8.300 (210.8)	1	70	13510
BBP85	130771	B-7569		4.100 (104.1)	6.100 (154.9)	1	90	13511
BBP85	130777	B-7569		6.100 (154.9)	8.300 (210.8)	1	70	13510



### MarkWare™ Software now includes a GHS / CLP Label Module

- 18 pre-formatted label layouts and approved GHS symbols are built-in
- User selects approved pre-worded hazard statements and GHS symbols which then automatically populates into layout – no need to type everything in
- Prompts for additional variable data which then auto-populates into layout
- Indoor/outdoor vinyl material withstands exposure to moisture, chemicals and handling
- Choose a second language and MarkWare auto-populates in the second language



Catalog #	Description
20700	MarkWare™ Software

Already a MarkWare Software user? Go to [BradyID.com/markware](http://BradyID.com/markware) to upgrade your current MarkWare to v3.9.1 for the GHS / CLP Label Module.



**New Brady Workstation GHS App Also Available!**  
See page 404 for more information.

View all BBP®85 Print Ribbon parts on page 396.

## Low-Halide Polyester (B-569)

For labeling stainless steel and smooth surfaces.

- Low-halide content for labeling stainless steel surfaces
- Applies best to very smooth surfaces and is ideal for mounting to rigid panels

Service temp: -40°F to 212°F Application temp: 0°F to 212°F  
Average Outdoor Durability: 3-5 years

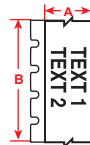

Figure 33



Fits Printer Model(s)	Diagram	Catalog #	B#	Color	Label Width A Inch (mm)	Roll Length B Feet (m)	Labels Per Roll	Rec. Ribbon
BBP85, PMK	Fig. 33	13565	B-569	White	4.000 (101.6)	50ft. (15.2m)	1 roll (cont)	13511
BBP85, PMK	Fig. 33	13569	B-569	White	6.000 (152.4)	50ft. (15.2m)	1 roll (cont)	13511
BBP85, PMK	Fig. 33	13573	B-569	White	7.000 (177.8)	50ft. (15.2m)	1 roll (cont)	13510
BBP85, PMK	Fig. 33	13577	B-569	White	10.000 (254.0)	50ft. (15.2m)	1 roll (cont)	13510
BBP85, PMK	Fig. 33	13566	B-569	Yellow	4.000 (101.6)	50ft. (15.2m)	1 roll (cont)	13511
BBP85, PMK	Fig. 33	13570	B-569	Yellow	6.000 (152.4)	50ft. (15.2m)	1 roll (cont)	13511
BBP85, PMK	Fig. 33	13574	B-569	Yellow	7.000 (177.8)	50ft. (15.2m)	1 roll (cont)	13510
BBP85, PMK	Fig. 33	13578	B-569	Yellow	10.000 (254.0)	50ft. (15.2m)	1 roll (cont)	13510
BBP85, PMK	Fig. 33	13567	B-569	Orange	4.000 (101.6)	50ft. (15.2m)	1 roll (cont)	13511
BBP85, PMK	Fig. 33	13571	B-569	Orange	6.000 (152.4)	50ft. (15.2m)	1 roll (cont)	13511
BBP85, PMK	Fig. 33	13575	B-569	Orange	7.000 (177.8)	50ft. (15.2m)	1 roll (cont)	13510
BBP85, PMK	Fig. 33	13579	B-569	Orange	10.000 (254.0)	50ft. (15.2m)	1 roll (cont)	13510
BBP85, PMK	Fig. 33	99167	B-569	Ochre	4.000 (101.6)	50ft. (15.2m)	1 roll (cont)	13511
BBP85, PMK	Fig. 33	99168	B-569	Ochre	6.000 (152.4)	50ft. (15.2m)	1 roll (cont)	13511
BBP85, PMK	Fig. 33	99169	B-569	Ochre	7.000 (177.8)	50ft. (15.2m)	1 roll (cont)	13510
BBP85, PMK	Fig. 33	99170	B-569	Ochre	10.000 (254.0)	50ft. (15.2m)	1 roll (cont)	13510
BBP85, PMK	Fig. 33	13564	B-569	Clear	4.000 (101.6)	50ft. (15.2m)	1 roll (cont)	13511
BBP85, PMK	Fig. 33	13568	B-569	Clear	6.000 (152.4)	50ft. (15.2m)	1 roll (cont)	13511
BBP85, PMK	Fig. 33	13572	B-569	Clear	7.000 (177.8)	50ft. (15.2m)	1 roll (cont)	13510
BBP85, PMK	Fig. 33	13576	B-569	Clear	10.000 (254.0)	50ft. (15.2m)	1 roll (cont)	13510

## Retro Reflective Tape (B-584)

For highly reflective identification that shines back brightly when struck by light.

- Ideal for labeling outdoor metal utility poles, pedestals, jobsite equipment and roof-top equipment especially in low light

Service temp: -40°F to 158°F Average Outdoor Durability: 4 to 6 years  
Application temp: 0°F to 158°F (yellow & orange), 50°F to 158°F (silver)

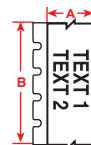

Figure 33



Fits Printer Model(s)	Diagram	Catalog #	B#	Color	Label Width A Inch (mm)	Roll Length B Feet (m)	Labels Per Roll	Rec. Ribbon
BBP85, PMK	Fig. 33	13580	B-584	Silver	4.000 (101.6)	33ft. (10.0m)	1 roll (cont)	13511
BBP85, PMK	Fig. 33	13585	B-584	Silver	7.000 (177.8)	33ft. (10.0m)	1 roll (cont)	13510
BBP85, PMK	Fig. 33	13590	B-584	Silver	10.000 (254.0)	33ft. (10.0m)	1 roll (cont)	13510
BBP85, PMK	Fig. 33	51584	B-584	Yellow	4.000 (101.6)	33ft. (10.0m)	1 roll (cont)	13511
BBP85, PMK	Fig. 33	51585	B-584	Yellow	7.000 (177.8)	33ft. (10.0m)	1 roll (cont)	13510
BBP85, PMK	Fig. 33	51586	B-584	Yellow	10.000 (254.0)	33ft. (10.0m)	1 roll (cont)	13510
BBP85, PMK	Fig. 33	13404	B-584	Orange	4.000 (101.6)	33ft. (10.0m)	1 roll (cont)	13511
BBP85, PMK	Fig. 33	13403	B-584	Orange	7.000 (177.8)	33ft. (10.0m)	1 roll (cont)	13510
BBP85, PMK	Fig. 33	13402	B-584	Orange	10.000 (254.0)	33ft. (10.0m)	1 roll (cont)	13510

## BradyGlo™ High-Intensity Photoluminescent Tape (B-526)

Identification that glows in the dark for up to 10 hours!

- Ideal for marking emergency utility shut-offs, fire extinguishers, alarm pulls, and vital equipment controls

Service temp: -40°F to 140°F Application temp: 40°F to 140°F

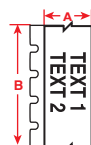

Figure 33



Fits Printer Model(s)	Diagram	Catalog #	B#	Color	Label Width A Inch (mm)	Roll Length B Feet (m)	Labels Per Roll	Rec. Ribbon
BBP85, PMK	Fig. 33	105912	B-526	Luminous Green	4.000 (101.6)	33ft. (10.0m)	1 roll (cont)	13511 or 13595
BBP85, PMK	Fig. 33	105913	B-526	Luminous Green	7.000 (177.8)	33ft. (10.0m)	1 roll (cont)	13510 or 13514
BBP85, PMK	Fig. 33	105914	B-526	Luminous Green	7.000 (177.8)	33ft. (10.0m)	1 roll (cont)	13510 or 13514

View all BBP®85 Print Ribbon parts on page 396.

# BBP®85 Print Ribbons

BradyID.com/s34

## BBP®85 Printer Ribbons

- Choose from a variety of heavy-duty, smear-proof ribbons, including single color and multi-color paneled ribbons. These ribbons are uniquely designed with memory cells that communicate information to the BBP®85 printer.

### Single Color Print Ribbons

Catalog #	Color	Size Inch (mm)	Length Inch (mm)
13511	Black	6.250 (158.0)	200 ft. (60.9 m)
13510	Black	8.800 (224.0)	200 ft. (60.9 m)
13513	White	6.250 (158.0)	200 ft. (60.9 m)
13512	White	8.800 (224.0)	200 ft. (60.9 m)
13595	Red	6.250 (158.0)	200 ft. (60.9 m)
13514	Red	8.800 (224.0)	200 ft. (60.9 m)
13596	Blue	6.250 (158.0)	200 ft. (60.9 m)
13515	Blue	8.800 (224.0)	200 ft. (60.9 m)
13597	Green	6.250 (158.0)	200 ft. (60.9 m)
13516	Green	8.800 (224.0)	200 ft. (60.9 m)
13598	Magenta	6.250 (158.0)	200 ft. (60.9 m)
13517	Magenta	8.800 (224.0)	200 ft. (60.9 m)
13599	Yellow	6.250 (158.0)	200 ft. (60.9 m)
13518	Yellow	8.800 (224.0)	200 ft. (60.9 m)
13600	Orange	6.250 (158.0)	200 ft. (60.9 m)
13519	Orange	8.800 (224.0)	200 ft. (60.9 m)



Example Single Color Print Ribbon



Example Two Color Panel Print Ribbon



Example Four Color Panel Print Ribbon

### Two Color Paneled Print Ribbons

Catalog #	Color	Ribbon Width Inch (mm)	Color Panel Length Inch (mm)	Overall Length	Typical Yield From Ribbon
<b>8" Panels used to create 2 color signs up to 8" long</b>					
13523	Black & Red	6.250 (158.0)	8.000 (203.2) Panels	200 ft. (60.9 m)	One hundred 8" long labels
13522	Black & Red	8.800 (223.5)	8.000 (203.2) Panels	200 ft. (60.9 m)	One hundred 8" long labels
13527	Black & Yellow	6.250 (158.0)	8.000 (203.2) Panels	200 ft. (60.9 m)	One hundred 8" long labels
13529	Black & Orange	6.250 (158.0)	8.000 (203.2) Panels	200 ft. (60.9 m)	One hundred 8" long labels
13704	Black & Green	6.250 (158.0)	8.000 (203.2) Panels	200 ft. (60.9 m)	One hundred 8" long labels
13706	Black & Green	8.800 (223.5)	8.000 (203.2) Panels	200 ft. (60.9 m)	One hundred 8" long labels
<b>15" Panels used to create 2 color signs up to 14" long</b>					
13521	Black & Red	6.250 (158.0)	15.000 (381.0) Panels	200 ft. (60.9 m)	Sixty 14" long labels
13520	Black & Red	8.800 (223.5)	15.000 (381.0) Panels	200 ft. (60.9 m)	Sixty 14" long labels
13525	Black & Blue	6.250 (158.0)	15.000 (381.0) Panels	200 ft. (60.9 m)	Sixty 14" long labels
13524	Black & Blue	8.800 (223.5)	15.000 (381.0) Panels	200 ft. (60.9 m)	Sixty 14" long labels
13526	Black & Yellow	8.800 (223.5)	15.000 (381.0) Panels	200 ft. (60.9 m)	Sixty 14" long labels
13528	Black & Orange	8.800 (223.5)	15.000 (381.0) Panels	200 ft. (60.9 m)	Sixty 14" long labels
13705	Black & Green	6.250 (158.0)	15.000 (381.0) Panels	200 ft. (60.9 m)	Sixty 14" long labels
13707	Black & Green	8.800 (223.5)	15.000 (381.0) Panels	200 ft. (60.9 m)	Sixty 14" long labels

### Four Color Paneled Print Ribbons

Catalog #	Color	Ribbon Width Inch (mm)	Color Panel Length Inch (mm)	Overall Length	Typical Yield From Ribbon
<b>8" Panels used to create 4 color signs up to 8" long</b>					
13533	Black/Red/Blue/Yellow	6.250 (158.0)	8.000 (203.2) Panels	200 ft. (60.9 m)	Fifty 8" long labels
13532	Black/Red/Blue/Yellow	8.800 (223.5)	8.000 (203.2) Panels	200 ft. (60.9 m)	Fifty 8" long labels
13537	Black/Red/Blue/Green	6.250 (158.0)	8.000 (203.2) Panels	200 ft. (60.9 m)	Fifty 8" long labels
13536	Black/Red/Blue/Green	8.800 (223.5)	8.000 (203.2) Panels	200 ft. (60.9 m)	Fifty 8" long labels
51448	Black/Red/Orange/Blue	8.800 (223.5)	8.000 (203.2) Panels	200 ft. (60.9 m)	Fifty 8" long labels
<b>15" Panels used to create 4 color signs up to 14" long</b>					
13531	Black/Red/Blue/Yellow	6.250 (158.0)	15.000 (381.0) Panels	200 ft. (60.9 m)	Thirty 14" long labels
13530	Black/Red/Blue/Yellow	8.800 (223.5)	15.000 (381.0) Panels	200 ft. (60.9 m)	Thirty 14" long labels
13535	Black/Red/Blue/Green	6.250 (158.0)	15.000 (381.0) Panels	200 ft. (60.9 m)	Thirty 14" long labels
13534	Black/Red/Blue/Green	8.800 (223.5)	15.000 (381.0) Panels	200 ft. (60.9 m)	Thirty 14" long labels

# Labelizer® Plus and VersaPrinter™ Supplies

BradyID.com/s34



## Discontinued Printer Supplies Still Available!

Material tapes for the Labelizer® PLUS and VersaPrinter™ machines are still manufactured and fully stocked. View all available parts on the following pages.

### Labelizer® Plus Industrial Labeling System



### VersaPrinter™ Label & Sign Maker



## Indoor/Outdoor Vinyl Tape (B-595)

- Adheres to pipes, walls, equipment, windows – most clean, dry surfaces
- Conforms well to irregular, curved or rough surfaces
- Ideal for general purpose industrial uses – stands up to grease, oil and most industrial chemicals
- 8-10 year average outdoor durability in temperatures from 180°F to -40°F (82°C to -40°C) and can be applied as low as 0°F (-18°C)



Catalog #	B#	Color	Label Width A Inch (mm)	Roll Length B Feet (m)	Cartridges Per Pkg.
142760	B-595	Black on Clear	0.500 (12.7)	90 ft (27.4 m)	2
142759	B-595	Black on Clear	1.125 (28.6)	90 ft (27.4 m)	2
142758	B-595	Black on Clear	2.250 (57.2)	90 ft (27.4 m)	1
142757	B-595	Black on Clear	4.000 (101.6)	90 ft (27.4 m)	1
142762	B-595	White on Clear	2.250 (57.2)	90 ft (27.4 m)	1
142765	B-595	Black on Green	1.125 (28.6)	90 ft (27.4 m)	2
142764	B-595	Black on Green	2.250 (57.2)	90 ft (27.4 m)	1
142763	B-595	Black on Green	4.000 (101.6)	90 ft (27.4 m)	1
142750	B-595	Black on Yellow	0.500 (12.7)	90 ft (27.4 m)	2
142749	B-595	Black on Yellow	1.125 (28.6)	90 ft (27.4 m)	2
142748	B-595	Black on Yellow	2.250 (57.2)	90 ft (27.4 m)	1
142747	B-595	Black on Yellow	3.000 (76.2)	90 ft (27.4 m)	1
142746	B-595	Black on Yellow	4.000 (101.6)	90 ft (27.4 m)	1
142769	B-595	White on Green	0.500 (12.7)	90 ft (27.4 m)	2
142768	B-595	White on Green	1.125 (28.6)	90 ft (27.4 m)	2
142767	B-595	White on Green	2.250 (57.2)	90 ft (27.4 m)	1
142766	B-595	White on Green	4.000 (101.6)	90 ft (27.4 m)	1
142777	B-595	White on Blue	0.500 (12.7)	90 ft (27.4 m)	2
142776	B-595	White on Blue	1.125 (28.6)	90 ft (27.4 m)	2
142775	B-595	White on Blue	2.250 (57.2)	90 ft (27.4 m)	1
142774	B-595	White on Blue	4.000 (101.6)	90 ft (27.4 m)	1
142745	B-595	Red on White	0.500 (12.7)	90 ft (27.4 m)	2
142744	B-595	Red on White	1.125 (28.6)	90 ft (27.4 m)	2
142743	B-595	Red on White	2.250 (57.2)	90 ft (27.4 m)	1
142742	B-595	Red on White	4.000 (101.6)	90 ft (27.4 m)	1
142772	B-595	White on Red	0.500 (12.7)	90 ft (27.4 m)	2
142773	B-595	White on Red	1.125 (28.6)	90 ft (27.4 m)	2
142771	B-595	White on Red	2.250 (57.2)	90 ft (27.4 m)	1
142770	B-595	White on Red	4.000 (101.6)	90 ft (27.4 m)	1
142741	B-595	Black on White	0.500 (12.7)	90 ft (27.4 m)	2
142740	B-595	Black on White	1.125 (28.6)	90 ft (27.4 m)	2
142739	B-595	Black on White	2.250 (57.2)	90 ft (27.4 m)	1
142738	B-595	Black on White	3.000 (76.2)	90 ft (27.4 m)	1
142737	B-595	Black on White	4.000 (101.6)	90 ft (27.4 m)	1
142756	B-595	Black on Orange	0.500 (12.7)	90 ft (27.4 m)	2
142755	B-595	Black on Orange	1.125 (28.6)	90 ft (27.4 m)	2
142754	B-595	Black on Orange	2.250 (57.2)	90 ft (27.4 m)	1
142753	B-595	Black on Orange	4.000 (101.6)	90 ft (27.4 m)	1
142785	B-595	Black on Gray	0.500 (12.7)	90 ft (27.4 m)	2
142784	B-595	Black on Gray	1.125 (28.6)	90 ft (27.4 m)	2
142783	B-595	Black on Gray	2.250 (57.2)	90 ft (27.4 m)	1
142782	B-595	Black on Gray	4.000 (101.6)	90 ft (27.4 m)	1

Continued on next page.



# Labelizer® Plus and VersaPrinter™ Supplies

BradyID.com/s34

## Indoor/Outdoor Vinyl Tape (B-595)

Continued from previous page.

Catalog #	B#	Color	Label Width A Inch (mm)	Roll Length B Feet (m)	Cartridges Per Pkg.
142793	B-595	White on Brown	1.125 (28.6)	90 ft (27.4 m)	2
142792	B-595	White on Brown	2.250 (57.2)	90 ft (27.4 m)	1
142791	B-595	White on Brown	4.000 (101.6)	90 ft (27.4 m)	1
142787	B-595	White on Tan	1.125 (28.6)	90 ft (27.4 m)	2
142786	B-595	White on Tan	2.250 (57.2)	90 ft (27.4 m)	1
142790	B-595	White on Magenta	1.125 (28.6)	90 ft (27.4 m)	2
142789	B-595	White on Magenta	2.250 (57.2)	90 ft (27.4 m)	1
142788	B-595	White on Magenta	4.000 (101.6)	90 ft (27.4 m)	1
142781	B-595	White on Black	0.500 (12.7)	90 ft (27.4 m)	2
142780	B-595	White on Black	1.125 (28.6)	90 ft (27.4 m)	2
142779	B-595	White on Black	2.250 (57.2)	90 ft (27.4 m)	1
142778	B-595	White on Black	4.000 (101.6)	90 ft (27.4 m)	1

## Low-Halide Polyester Tape (B-569)

- Specially designed with a low halide content – best choice for use on stainless steel and nickel piping and other smooth surfaces
- 8-10 year average outdoor durability in temperatures from 180°F to -40°F (82°C to -40°C) and can be applied as low as 0°F (-18°C)



Catalog #	B#	Color	Label Width A Inch (mm)	Roll Length B Feet (m)	Cartridges Per Pkg.
64347	B-569	Black on Clear	1.125 (28.6)	110 ft (33.5 m)	2
64348	B-569	Black on Clear	2.250 (57.2)	110 ft (33.5 m)	1
64349	B-569	Black on Clear	4.000 (101.6)	110 ft (33.5 m)	1
64326	B-569	Black on Yellow	0.500 (12.7)	110 ft (33.5 m)	2
64327	B-569	Black on Yellow	1.125 (28.6)	110 ft (33.5 m)	2
64328	B-569	Black on Yellow	2.250 (57.2)	110 ft (33.5 m)	1
64329	B-569	Black on Yellow	4.000 (101.6)	110 ft (33.5 m)	1
64331	B-569	White on Green	1.125 (28.6)	110 ft (33.5 m)	2
64332	B-569	White on Green	2.250 (57.2)	110 ft (33.5 m)	1
64333	B-569	White on Green	4.000 (101.6)	110 ft (33.5 m)	1
64335	B-569	White on Blue	1.125 (28.6)	110 ft (33.5 m)	2
64336	B-569	White on Blue	2.250 (57.2)	110 ft (33.5 m)	1
64339	B-569	White on Red	1.125 (28.6)	110 ft (33.5 m)	2
64340	B-569	White on Red	2.250 (57.2)	110 ft (33.5 m)	1
64355	B-569	Black on White	1.125 (28.6)	110 ft (33.5 m)	2
64356	B-569	Black on White	2.250 (57.2)	110 ft (33.5 m)	1
64357	B-569	Black on White	4.000 (101.6)	110 ft (33.5 m)	1

## Reflective Tape (B-584)

- Use both indoors and outdoors
- Reflective capabilities are ideal for reading labels in low light areas
- Locate labels from your vehicle with a flashlight



Catalog #	B#	Color	Label Width A Inch (mm)	Roll Length B Feet (m)	Cartridges Per Pkg.
64739	B-584	Black on White	1.125 (28.6)	75 ft (22.8 m)	2
64740	B-584	Black on White	2.250 (57.2)	75 ft (22.8 m)	1
64741	B-584	Black on White	4.000 (101.6)	75 ft (22.8 m)	1
64400	B-584	Black on Orange	1.125 (28.6)	69 ft (21.0 m)	2
64401	B-584	Black on Orange	2.250 (57.2)	58 ft (17.7 m)	1
64402	B-584	Black on Orange	4.000 (101.6)	75 ft (22.8 m)	1
64403	B-584	Black on Yellow	1.125 (28.6)	69 ft (21.0 m)	2
64404	B-584	Black on Yellow	2.250 (57.2)	58 ft (17.7 m)	1
64405	B-584	Black on Yellow	4.000 (101.6)	75 ft (22.8 m)	1

## Overlaminates (B-674)

- Provides improved label durability
- Hand applied after label is applied



Catalog #	B#	Color	Label Width A Inch (mm)	Roll Length B Feet (m)	Cartridges Per Pkg.
25966	B-674	Clear	0.750 (19.05)	30 ft (9.1 m)	1
25967	B-674	Clear	1.375 (34.9)	30 ft (9.1 m)	1
25968	B-674	Clear	2.500 (63.5)	30 ft (9.1 m)	1
25969	B-674	Clear	4.250 (107.9)	30 ft (9.1 m)	1

## Cold Temperature Tape (B-549)

- Permanently adheres to surfaces at temperatures as low as -10°F (application temp.). Service temperature to -40°F
- Great for use in any cold storage warehouse, cooler or freezer
- Stands up to chemicals, water, oil and many solvents



Catalog #	B#	Color	Label Width A Inch (mm)	Roll Length B Feet (m)	Cartridges Per Pkg.
64776	B-549	Black on White	2.000 (50.8)	90 ft (27.4 m)	1
46237	B-549	Black on White	3.000 (76.2)	90 ft (27.4 m)	1

## Repositionable Vinyl Tape (B-581)

- Special adhesive allows easy removal of label with reapplication again and again
- Label of choice for indoor marking where frequent repositioning is required, such as storage shelves



Catalog #	B#	Color	Label Width A Inch (mm)	Roll Length B Feet (m)	Cartridges Per Pkg.
64731	B-581	Black on White	1.125 (28.6)	90 ft (27.4 m)	2
64732	B-581	Black on White	2.250 (57.2)	90 ft (27.4 m)	1
64733	B-581	Black on White	4.000 (101.6)	90 ft (27.4 m)	1
64735	B-581	Black on Yellow	1.125 (28.6)	90 ft (27.4 m)	2
64736	B-581	Black on Yellow	2.250 (57.2)	90 ft (27.4 m)	1
64737	B-581	Black on Yellow	4.000 (101.6)	90 ft (27.4 m)	1



### Did You Know? BradyID.com

BradyID.com offers online ordering and instant access to:

- Product Info
- Product Demos
- Custom Orders
- Whitepapers
- Webinars
- And More!



# Additional Benchtop Printer Materials

BradyID.com/s34

## Make Your Own Signs with Rigid Sign Panels

Sign blanks let you laminate output using the BLS1255 Laminator.

These plastic and aluminum blanks are sized to fit output and come in white, yellow and orange.

### Plastic - rounded corners and hole punched

Catalog #	Material	Color	Sign Size Inch (mm)	Qty.
13620	Plastic	White	4.25" x 6.25"	10
13623	Plastic	White	7.63" x 10.38"	10
13626	Plastic	White	10.25" x 14.25"	10
13621	Plastic	Yellow	4.25" x 6.25"	10
13624	Plastic	Yellow	7.63" x 10.38"	10
13627	Plastic	Yellow	10.25" x 14.25"	10
13622	Plastic	Orange	4.25" x 6.25"	10
13625	Plastic	Orange	7.63" x 10.38"	10
13628	Plastic	Orange	10.25" x 14.25"	10

### Aluminum - rounded corners and hole punched

Catalog #	Material	Color	Sign Size Inch (mm)	Qty.
13629	Aluminum	White	4.25" x 6.25"	10
106461	Aluminum	White	4.25" x 10.25"	10
13632	Aluminum	White	7.63" x 10.38"	10
106460	Aluminum	White	7.25" x 18.25"	10
106462	Aluminum	White	10.25" x 10.25"	10
13635	Aluminum	White	10.25" x 14.25"	10
13630	Aluminum	Yellow	4.25" x 6.25"	10
13633	Aluminum	Yellow	7.63" x 10.38"	10
13636	Aluminum	Yellow	10.25" x 14.25"	10
13631	Aluminum	Orange	4.25" x 6.25"	10
13634	Aluminum	Orange	7.63" x 10.38"	10
13637	Aluminum	Orange	10.25" x 14.25"	10



**Blank Sign Panels!**



Benchtop Printers



## Make Your Own Valve Tags

- Print labels on your Brady printer, and apply to these durable plastic tags for a custom tag solution
- Withstands temps -40°F (-40°C) to 180°F (82°C)
- Tag Size
  - 1.5" x 3" Tag accepts labels 1.25" x 2.85" or smaller
  - 2.5" x 4" Tag accepts labels 2.25" x 3.85" or smaller



Choose from 10 different colors!

Catalog #	Color	Tag Width A Inch (mm)	Tag Height B Inch (mm)
41920	Black	1.500 (38.1)	3.000 (76.2)
41921	Black	2.500 (63.5)	4.000 (101.6)
41922	Yellow	1.500 (38.1)	3.000 (76.2)
41923	Yellow	2.500 (63.5)	4.000 (101.6)
41924	Red	1.500 (38.1)	3.000 (76.2)
41925	Red	2.500 (63.5)	4.000 (101.6)
41926	Blue	1.500 (38.1)	3.000 (76.2)
41927	Blue	2.500 (63.5)	4.000 (101.6)
41928	Green	1.500 (38.1)	3.000 (76.2)
41929	Green	2.500 (63.5)	4.000 (101.6)
87694	Orange	1.500 (38.1)	3.000 (76.2)
87695	Orange	2.500 (63.5)	4.000 (101.6)
87696	White	1.500 (38.1)	3.000 (76.2)
87697	White	2.500 (63.5)	4.000 (101.6)
87698	Gray	1.500 (38.1)	3.000 (76.2)
87699	Gray	2.500 (63.5)	4.000 (101.6)
87710	Brown	1.500 (38.1)	3.000 (76.2)
87711	Brown	2.500 (63.5)	4.000 (101.6)
87712	Tan	1.500 (38.1)	3.000 (76.2)
87713	Tan	2.500 (63.5)	4.000 (101.6)
142133	Variety Pack*	-	-

\* Variety Pack combines 30 tags including at least one of each size and color. Perfect for evaluating which sizes and colors you need.



**Don't Miss: Tag Labels Sized to Fit**

**BBP®31 & BBP®33 Tag Labels**  
See page 360

**GlobalMark®2 Tag Labels**  
See page 384



# Additional Benchtop Printer Materials

BradyID.com/s34



## Blank High Performance Wrap-Around Pipe Marker

- Create custom Wrap-Around Pipe Markers with your printer
- Self-adhesive strip holds pipemarker securely in place
- Service temp: -40°F (-40°C) to 248°F (120°C)

Catalog #	Color	Fits Pipe Outside Diameter Inch (mm)
5600-I	Blue	1.500 - 2.375 (38.1 - 60.3)
5600-II	Blue	2.500 - 7.875 (63.5 - 200.0)
5603-I	Yellow	1.500 - 2.375 (38.1 - 60.3)
5603-II	Yellow	2.500 - 7.875 (63.5 - 200.0)
5602-I	Red	1.500 - 2.375 (38.1 - 60.3)
5602-II	Red	2.500 - 7.875 (63.5 - 200.0)
5601-I	Green	1.500 - 2.375 (38.1 - 60.3)
5601-II	Green	2.500 - 7.875 (63.5 - 200.0)



## Blank HPHV Carrier

- Ideal for marking custom markers on the spot
- Fiberglass carrier is blank (no label) and comes with two clips for installation
- Sized to accommodate the largest ASME (ANSI) requirements

Catalog #	Description	Size
59918	Blank HPHV Carrier	4.25" x 32"



## Fastening Devices

- 32 mil stainless steel safety wire to be used with wire twister pliers.

Catalog #	Outside Dia.	Length
15424	Stainless Steel Safety Wire	1800 ft



Label produced on Brady Printer

Snap-on marker

## Make Your Own BradySnap-On™ Pipe Markers

- Use blank Brady Snap-On™ Pipe Markers (B-915 material) in combination with self-sticking pipe markers produced on your Brady printers
- Pre-coiled to snap around pipe

Catalog #	Color	Length of Marker Inch (mm)	Fits Pipe Outside Diameter Inch (mm)
4010-A	Yellow	Yellow	0.750 - 1.375 (19.1 - 34.9)
4010-B	Yellow	Yellow	1.500 - 2.375 (38.1 - 60.3)
4010-F	Yellow	Yellow	6.000 - 9.875 (152.4 - 250.8)
4010-C	Yellow	Yellow	2.500 - 3.875 (63.5 - 98.4)
42300	Yellow	Yellow	0.750 - 1.375 (19.1 - 34.9)
42304	Yellow	Yellow	1.125 - 2.375 (28.6 - 60.3)
4010-D	Yellow	Yellow	4.000 - 6.000 (101.6 - 152.4)
4010-H	Yellow	Yellow	10.000 - 15.000 (254.0 - 381.0)
4011-A	Green	Green	0.750 - 1.375 (19.1 - 34.9)
4011-B	Green	Green	1.500 - 2.375 (38.1 - 60.3)
4011-F	Green	Green	6.000 - 9.875 (152.4 - 250.8)
4011-C	Green	Green	2.500 - 3.875 (63.5 - 98.4)
42301	Green	Green	0.750 - 1.375 (19.1 - 34.9)
42305	Green	Green	1.125 - 2.375 (28.6 - 60.3)
4011-D	Green	Green	4.000 - 6.000 (101.6 - 152.4)
4011-H	Green	Green	10.000 - 15.000 (254.0 - 381.0)
4012-A	Red	Red	0.750 - 1.375 (19.1 - 34.9)
4012-B	Red	Red	1.500 - 2.375 (38.1 - 60.3)
4012-F	Red	Red	6.000 - 9.875 (152.4 - 250.8)
4012-C	Red	Red	2.500 - 3.875 (63.5 - 98.4)
42302	Red	Red	0.750 - 1.375 (19.1 - 34.9)
42306	Red	Red	1.125 - 2.375 (28.6 - 60.3)
4012-D	Red	Red	4.000 - 6.000 (101.6 - 152.4)
4012-H	Red	Red	10.000 - 15.000 (254.0 - 381.0)
4013-A	Blue	Blue	0.750 (19.1) - 1.375 (34.9)
4013-B	Blue	Blue	0.750 - 1.375 (19.1 - 34.9)
4013-F	Blue	Blue	6.000 - 9.875 (152.4 - 250.8)
4013-C	Blue	Blue	2.500 - 3.875 (63.5 - 98.4)
42303	Blue	Blue	0.750 (19.1) - 1.375 (34.9)
42307	Blue	Blue	1.125 - 2.375 (28.6 - 60.3)
4013-D	Blue	Blue	4.000 - 6.000 (101.6 - 152.4)
4013-H	Blue	Blue	10.000 - 15.000 (254.0 - 381.0)

\*outside diameter includes pipe O.D. plus any insulation.

## Quik-ApPLY™ Nylon Straps

- Standard fastener for Quik-ApPLY™ pipe marker sizes Q1-Q4
- Can be used with a variety of tags including valve and lockout/tagouts



Catalog #	Outside Dia.	Strap Length
91165	1"	6"
91166	2"	7"



# Brady BLS1255 Laminator

BradyID.com/s34



Laminates documents up to 12" wide!

**No Heat! No Electricity!  
No Messy Chemicals!**

Mount PowerMark™ output to plastic or aluminum sign panels in 3 easy steps!



Step 1: Peel away the first 1-1/2" of liner from the back of PowerMark™ printer output. Apply to blank panel, aligning edge of label with edge of panel.



Step 2: Insert sign into laminator and rotate handle until first 1" of sign is "pinched".

Stop. Then grasp liner of sign and pull at the same time as you rotate handle rapidly advancing sign through the laminator.



Step 3: In less than 30 seconds you have a rigid sign ready to hang. Choose from aluminum, plastic or clear acrylic panel materials.

## BLS1255 Laminating System

Quickly mount PowerMark™ output to plastic or aluminum sign blanks... takes only seconds!

### Laminating Options:

- Mount label to a rigid plastic or aluminum sign panel
- Mount label behind a rigid, clear acrylic sign panel to add rigidity while protecting the graphics...polished look for office areas
- Overlaminates documents with a single or double-sided flexible, clear overlaminate

### BLS1255 Laminating System

Catalog #	Outside Dia.
105038	BLS1255 Laminating System
105041	12" x 50' Double-sided polyester overlaminate



**Use the BLS1255 laminator to mount your PowerMark™ output to a rigid plastic or aluminum panel...in seconds.**

### Plastic - rounded corners and hole punched

Catalog #	Material	Color	Size	Qty. Per Package
13620	Plastic	White	4.25" x 6.25"	10
13623	Plastic	White	7.63" x 10.38"	10
13626	Plastic	White	10.25" x 14.25"	10
13621	Plastic	Yellow	4.25" x 6.25"	10
13624	Plastic	Yellow	7.63" x 10.38"	10
13627	Plastic	Yellow	10.25" x 14.25"	10
13622	Plastic	Orange	4.25" x 6.25"	10
13625	Plastic	Orange	7.63" x 10.38"	10
13628	Plastic	Orange	10.25" x 14.25"	10

### Aluminum - rounded corners and hole punched

Catalog #	Material	Color	Size	Qty. Per Package
13629	Aluminum	White	4.25" x 6.25"	10
106461	Aluminum	White	4.25" x 10.25"	10
13632	Aluminum	White	7.25" x 10.25"	10
106460	Aluminum	White	7.63" x 10.38"	10
106462	Aluminum	White	10.25" x 10.25"	10
13635	Aluminum	White	10.25" x 14.25"	10
13630	Aluminum	Yellow	4.25" x 6.25"	10
13633	Aluminum	Yellow	7.25" x 10.25"	10
13636	Aluminum	Yellow	10.25" x 14.25"	10
13631	Aluminum	Orange	4.25" x 6.25"	10
13634	Aluminum	Orange	7.25" x 10.25"	10
13637	Aluminum	Orange	10.25" x 14.25"	10

### Clear acrylic panels with pressure sensitive adhesive

- Use to mount output behind a clear panel to add rigidity while protecting the graphics...polished finish for office areas.
- Sign panel and overlaminates in one step

Catalog #	Material	Color	Size	Qty. Per Package
13638	Acrylic	Clear	4" x 6"	10
106464	Acrylic	Clear	4.25" x 10.25"	10
13639	Acrylic	Clear	7.25" x 10"	10
106463	Acrylic	Clear	7.25" x 10.25"	10
13640	Acrylic	Clear	10" x 14"	10
106465	Acrylic	Clear	10.25" x 10.25"	10

# Brady BLS850 Laminator

BradyID.com/s34



**No Heat!  
No Electricity!  
No Problem!**

**Use a BLS850 to finish:**

- Signs
- Labels
- Graphs
- Certificates
- ID Badges
- ISO Documents
- Maps
- Photos
- Tags
- Wall Charts
- Procedures
- Phone Lists

**Brady's Easy-to-Use BLS850 Laminator Covers it All**



1. Select desired cartridge, insert a document and turn the handle.



2. As it passes through the rollers, the adhesive and laminate are evenly applied.



3. The cut-off blade provides a precise trim to finish documents.

## BLS850 Laminating System

- An affordable and easy way to create laminated documents up to 8-1/2" wide without heat or electricity
- Laminate documents in seconds
- Perfect for office use or industrial applications
- Small, portable desktop laminator works without electricity, heat or messy chemicals
- Economically priced and endless applications

### Features

- Three replaceable supply cartridge types (double-sided laminate, single-sided overlaminate, laminate with transfer adhesive)
- Integral cut-off blade at roller exit
- Laminates documents 8-1/2" wide and up to 100' long
- Small, lightweight and portable
- Laminates with Brady's EXCLUSIVE industrial grade laminate!
- Brady's exclusive industrial grade overlaminate is constructed from tough polyester for durability even in harsh environments
- Significantly superior to typical polypropylene overlaminates in terms of outdoor performance and abrasion resistance

### BLS850 Laminating System

Catalog #	Outside Dia.	Supply Size
20585	BLS850 Laminator	-
20589	Clear Double-Sided Laminate	8-3/5" x 50' (21.8 cm x 15.2 m)
20602	Clear Double-Sided Laminate	8-3/5" x 100' (21.8 cm x 30.5 m)



Provides the perfect finishing touch for your Brady printer.



Laminator allows you to laminate one side of document while applying adhesive to reverse.



Laminate your most frequently reached for documents.

**Need to laminate documents wider than 8-1/2"?  
See the BLS1255 on the previous page.**



# Brady Workstation

workstation.bradyd.com

**FREE  
Apps!**



## Brady Workstation

### A Desktop App Solution for Labeling & Safety Identification

Brady has revolutionized the way you create labels on your PC with the new Brady Workstation and its apps that are specific to the projects you want to execute. It's built to be simple – just pick the apps you need and get the job done fast.

After downloading the Brady Workstation to your PC, you fill your workstation with a variety of Brady labeling apps such as the Express Signs app, Pipe Marker app, Custom Designer app, Lockout Writer app, GHS Labels app and more. These apps feature built in regulations and standards to help you create sign and labels to keep your facility compliant and safe.

In addition, building your own signs, pipe markers, lockout procedures and labels with ease gives you time to spare for your other projects.



#### Get the Free App Today!

Visit [workstation.bradyd.com](http://workstation.bradyd.com) to download the program and choose from several apps, including Express Signs app, Pipe Marker app, Custom Designer app and Lockout Writer app.



1. Download Brady Workstation at [workstation.bradyd.com](http://workstation.bradyd.com)



2. Fill the workstation with the apps you want and leave out the ones you don't.



3. Save time by quickly designing labels and printing them on your BBP®31, BBP®33, BBP®85 and GlobalMark®2 printers.

### Apps are made to work for you.

Pictograms, common phrases, data importing, guidance and help functions are all baked right into the apps from the start. That means making labels that are fully compliant with the latest safety regulation is a breeze, whether you're a seasoned expert or just getting started.

## Build your own signs and labels with ease.

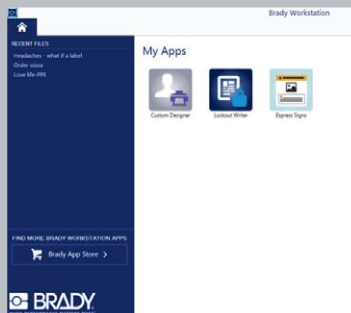

Download your desired apps.

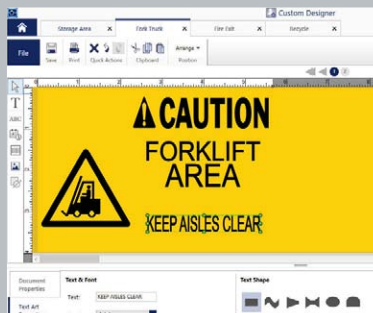

Create custom labels.

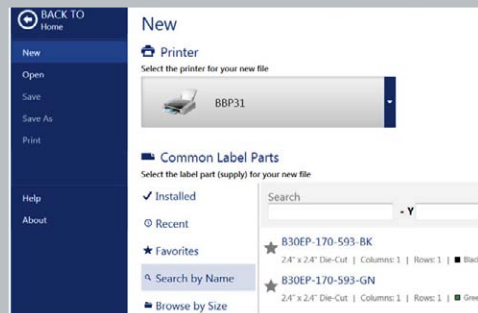

Send the label to your printer.



## Brady Workstation Apps

There are several label creation apps within Brady Workstation to fit a wide variety of applications. Don't need all of the apps? No problem! Once Brady Workstation is downloaded to your PC, you can choose which apps you want and leave out the ones you don't. Most of the apps are free, while others are paid with the option of a 14-day free trial.



### Custom Designer app

Design anything you can imagine in this app. Start with a blank canvas to create a label or sign that meets your unique needs. Add barcodes or QR codes, import data from Excel and more!



### Pipe Marker app

Easily comply with the latest pipe marking standard, ANSI/ASME 13.1 2007. This app allows you to create the customized pipe markers you need, then save them to use again whenever you want more.



### Express Signs app

Create your signs in no time - simply pick a template, enter your info and it's ready in minutes. Don't like the layouts? Adjust them. Don't worry, we won't make you redo your work.



### Arrow Tape app

Beyond creating a pipe marker, you need to know what direction the pipe contents are flowing. With this app, create a strip of repeated arrows or icons to wrap around your pipe and show content direction.



### GHS Labels app

Creating GHS labels is now amazingly simple. Enter your SDS data one time, and you can create any size label and print it at any time.



### Lockout Writer app

Quickly create compliant lockout/tagout labels. This app includes procedure printing templates, simple translations, easy-to-use image editing for callouts, and import capabilities from Lockout-Pro™ software.

**Additional apps will be released throughout the year, so check back on workstation.bradyid.com for updates.**

**More apps to come!**

## MarkWare™ Facility Identification Software is still available:

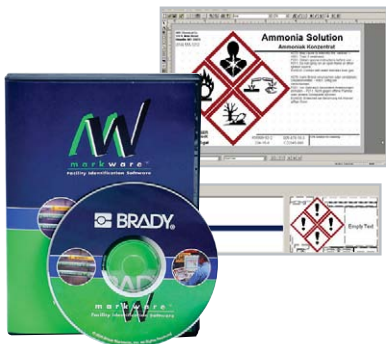

For more information, visit [BradyID.com/markware](http://BradyID.com/markware)

### MarkWare™ Facility Identification Software with GHS / CLP Label Module

Save time and costs and by creating custom safety signs for your facility with MarkWare™ Software. Use your PC to quickly design professional looking signs and labels and print directly to a Brady labeling system.

- Includes 18 pre-formatted GHS label layouts and approved symbols
- User selects approved pre-worded GHS hazard statements and GHS symbols
- Pre-formatted templates make sign and label creation quick and easy Import logos and photos or create bar codes using 15 different symbologies
- Link label contents to information stored in spreadsheets and databases

### MarkWare™ Lean Tools Facility Identification Software

Includes all of the features and functionality of MarkWare™ standard software, plus tools to support and sustain your lean transformation. Post critical information at the point of use when implementing 5S, Total Productive Maintenance, Standard Work, Kanban, or other lean concepts.

*Already a MarkWare Software user and want the GHS / CLP Module? Upgrade your current MarkWare by visiting [BradyID.com/Markware](http://BradyID.com/Markware) and going to "Software Downloads".*

# InspectNTrack™ Software

BradyID.com/s34

Software



## InspectNTrack™ Software

Brady's InspectNTrack™ Software effectively manages your inspections to ensure they are on-time and accurate.

Brady's ground-breaking InspectNTrack™ Software eliminates the need for the traditional paper-based, manual log-sheets and improves what matters most when it comes to inspections: efficiency, accuracy, tracking and visibility. Our user-friendly system offers a painless, inspection tracking experience from start to finish.

In addition, InspectNTrack™ Software helps companies take a proactive approach to inspection management by standardizing the format, process and tracking elements. It also features time-and date-stamps to label activities and help your company keep documentation accurate.



### More Information!

Visit [BradyID.com/InspectNTrack](http://BradyID.com/InspectNTrack) for more information on InspectNTrack Software.

### The InspectNTrack Advantage:

- Generate automated inspection reports – no paper needed!
- Easily standardize the inspection process throughout multiple sites
- Keep inspection information at your fingertips with iOS devices
- Easily track inspections and quickly identify and eliminate missed inspections

### InspectNTrack Allows you to track and manage inspections for:

- Fire Equipment
- Eyewash/Showers
- Emergency Lighting
- Extension Cords
- Respirators
- Fall Protection Equipment
- Ladders
- Cranes
- Chemical Storage
- Chemical Labeling
- Lab Safety
- Physical Security and more!



Fire & Life Safety Equipment



Manufacturing Equipment



Property Maintenance



Vehicles & Equipment



EH&S, OSHA and EPA Audits

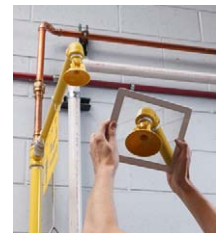

Safety Equipment



## Request A Demo:

Call 1-888-311-0774 or email [ClientServices@bradycorp.com](mailto:ClientServices@bradycorp.com) to request a product demo.

### THE LINK360® ADVANTAGE:

- Cloud-based software allows for program scalability and access from mobile and tablet devices (iOS and Android)
- User-defined permission for viewing, editing and approving helps ensure the correct people are doing the correct activities
- Pre-defined templates and standardized procedures allow for multi-site standardization
- Workflow and responsibility assignments for sites, areas and equipment improves employee accountability around machine safety and productivity
- Audit alerts, notification and detailed reporting help companies keep information up to date

## LINK360® Software

Brady's LINK360® cloud based software was built with our clients in mind. We understand that when it comes to machine safety, each member on your team shares responsibilities. That's why LINK360's one-of-a-kind workflow and collaborative nature encourages cultural buy in from your team to help you establish and promote a world-class safety culture. To keep your procedures secure and ensure only authorized people are accessing your information, permission is required to access various elements of the software.

To manage, store and sustain machine safety and procedural information, LINK360 offers procedure creation, procedure maintenance, audit reminders and more. From smaller local companies to larger Fortune 100 companies, our clients utilize this software to increase their multi-facility program standardization and reporting capabilities.

LINK360 currently offers three Centers that address common areas of focus when operating your equipment safely:

- Lockout/Tagout
- Confined Space
- Reliability/Maintenance

We are continuously innovating and creating new Centers to meet your industry needs!

### A Snapshot of LINK360® Software:

- Cloud-based software with free mobile apps
- Create and update procedures and permits
- Facilitate reviews, comments and approvals
- Setup regularly scheduled audit processes and reminders
- Time-stamping and record keeping
- Comprehensive procedure management tool



# LabelMark™ Labeling Software

BradyID.com/s34

## LabelMark™ Labeling Software For Wire & Cable, Laboratory and General Industrial Labeling

With single-click importing and serialization, an interactive custom label creator and integration with MS Office and AutoCAD applications, LabelMark™6 Software is a user-friendly label design and printing program for high performance labeling.

### NEW Look and Label Design Capabilities

- Save time with new label set up and data management features
- Apply imported data and serialization legends to labels with a few clicks
- Use electrical and laboratory labeling apps to create the jobs' necessary labels
- Manage multiple files in a single job by grouping wire markers, push buttons, rating plates, and terminal block labels into one job file

### Label Designs

- New and improved User Interface
- Easy-to-use apps for creating labels for wire harness and control panel and laboratory jobs
- Insert and edit AutoCAD layers, area of interests or entire files onto labels
- Automatically repeat text on multiple lines of a label with LabelMark wire marker too
- Multi-label view for true representation of label formats
- Adjust each individual label's length in your print file to your specifications.

### Data Management

- Import data onto a label from an external data source within a few clicks
- One-step serialization of data
- "Check error" function to locate any errors in imported data prior to printing the labels

### Label Printing

- Assign label materials to a specific printer for dedicated printing
- Create one job to simultaneously manage multiple print jobs and printers
- Bi-directional communication with the IP™ Printer, BMP®41, BMP®51, BMP®53, BMP®71 and BBP®33 printer series for automatic label format loading



### Free 30-Day Trial:

Visit [BradyID.com/Labelmark](http://BradyID.com/Labelmark) to watch tutorial videos or download a 30-day trial.



Breakerbox



Wire & Cable



Control Panels



Voice & Data



Circuit Boards



General ID





## NetDoc® Network Cable Management Software Take Control of Your Network

NetDoc® Network Cable Management Software provides you with the tools you need to manage cabling, network, telephony and legacy connections. NetDoc® allows you to easily document horizontal and backbone cables, hardware, assets, pathways, locations, users and much more! This web-enabled solution provides complete ANSI/TIA/EIA 606B documentation compliance. And, its seamless integration with LabelMark™ Software gives you a complete documentation and labeling solution to help increase productivity, reduce costs, and improve user services!

**Request A Demo:**  
Visit [BradyID.com/Netdoc](http://BradyID.com/Netdoc) to request a product demo.



Wire & Cable Labeling



Cable Management Software



Voice & Data Equipment Labeling



Network Documentation



...And More!



## CodeSoft™ Labeling Software For Enterprise Level ID and 3rd Party Software Integration.

This enterprise-level label design software allows users to design and print custom labels for product identification and tracking. CodeSoft Barcode Software is the professional solution for the most complex barcode labeling projects. CodeSoft excels at integrating with users systems and 3rd party software.

The software provides a range of barcode label design features for any project, from easy label designs to general bar coding. Brady Labeling Software gives you the power to design and print labels with ease and flexibility. Whether you need to print text, barcodes or graphic images, fixed or variable data, user defined or database driven, Brady has the barcode and labeling software to handle all your custom label needs.

**Request A Demo:**  
Visit [BradyID.com/Codesoft](http://BradyID.com/Codesoft) to request a demo.



Rating Plate Identification



Voice & Data Communications



Circuit Board Labels



Control Panel Labeling



General ID ...and many more!



### SENTINEL Software Add-On

Automated, mapping capabilities, for lights out printing. Allows for integration of CodeSoft labeling software with existing Networked Systems. (LIMS, SAP, EMR, and other popular ERP systems)



### LabelArchive Software Add-On

Create label approval process, full traceable solution for all printed labels, secure label repository.



### CENTRAL GHS Software Add-On

Assure complete GHS compliance. Package includes design (CodeSoft), automation (SENTINEL), and label approval modules (LabelArchive).



# Absorbents and Spill Control

BradyID.com/SPC



## Regulations

The following OSHA and EPA regulations protect your employees and the environment:

### 29 CFR 1910.22(a)(2)

Clean, dry workplace floors.

### 40 CFR 112.7(c)(1)(vii)

Absorbent materials are one option for preventing oil spills from reaching waterways.

### 29 CFR 1910.120(j)(1)(vii)

DOT-specified containers and suitable quantities of absorbents shall be kept available for response to spills.



## Why SPC Products?

For more than 30 years, SPC products have helped customers protect against leaks, drips and spills that create safety hazards in the workplace. Brady provides high-quality service, application expertise and product knowledge to SPC distributors and customers.

Brady SPC has a history of innovation and continues to develop industry-leading products and applications. With an ever expanding portfolio, Brady SPC is committed to providing customers with the right product for the right application at the right price point.

## Why Is Spill Control Important?

A proper spill control program can create a safe and productive work environment for your employees in addition to protecting our environment.

By complying with EPA and OSHA regulations for spill control, a facility can increase productivity and limit equipment down time. In addition, the cost of non-compliance around this area of regulation can have devastating effects on a business' reputation and financial performance.

### Spill Prevention Control & Countermeasure (SPCC) Plan

The EPA issued its final rule amending the SPCC under the authority of the Federal Water Pollution Control Act. This regulation became effective as of August 16, 2002.

### What is an SPCC Plan?

An SPCC plan is a facility-specific, comprehensive plan outlining both the containment and countermeasures implemented to prevent a spill from occurring and a series of response procedures in the event that one does.

The SPCC plan addresses the following three areas:

- Operating procedures that prevent spills
- Control measures installed to prevent a spill from reaching the environment
- Countermeasures to contain, clean-up and mitigate the effects of a spill that reaches the environment

## Confused On Which Absorbents To Use? Consider an Absorbent Survey!

Brady's Absorbent Survey is a free service designed to help a facility keep its employees and equipment safe while also accounting for OSHA, EPA and SPCC regulations. Surveys are conducted by Brady SPC's regional absorbent sales managers, industry experts who ask the right questions, provide solutions based on your needs and present a full summary of findings.

Contact your Brady SPC Representative to set up your own Absorbent Survey!



## Did You Know? SPC Absorbents vs. Clay

There is a negative financial impact of using clay to clean-up your leaks, drips and spills. It may be cheaper to buy, but the benefits stop there. For example, a facility that uses sorbents to clean up 32 gallons of oil on average each month may expect to spend as follows\*:

### Using Clay:

- 8 - 30lb. bags @ \$9 each = \$72
- 2 disposal drums @ \$350 each = \$700
- Total spend = \$772

### Using SPC Sorbents

- 1 bale of pads @ \$76 = \$76
- 1 disposal drum @ \$350 = \$350
- Total spend = \$426

### A 45% SAVINGS WITH SPC

### Still not convinced? Consider these points:

- OSHA considers silica a serious health hazard.
- Granular clean-up is difficult and labor intensive small particles can easily enter and damage machinery or your finished product.
- Clay has limited chemical resistance.

With Brady's SPC Absorbents, all of these shortcomings are eliminated!



\* This is a basic analysis using estimations and averages. Individual situations will vary. Contact your BRADY/SPC Regional Absorbent Sales Manager to do a more in-depth and customized analysis of your costs.

## 1 Step One: Know What You're Absorbing



### Universal Absorbents

All-purpose products that clean-up oils, coolants, solvents and water-based fluids anywhere in your facility. Use around machinery, under leaky pipes, in messy traffic areas or for general maintenance projects.



### Oil Only Absorbents

These absorbents are specialized for oil and other petroleum-based spills including paints and other non-water soluble chemicals. These absorbents will not absorb water and will float indefinitely.



### Chemical Absorbents

Surfactant-treated polypropylene absorbents can be used on a wide range of chemicals, including hydrofluoric acid. They are chemically inert, so they will not react with aggressive fluids.

## 2 Step Two: Identify Your Absorbent Application



### Wiping, Dripping or Foot Traffic Applications

#### Pads & Rolls

For use for wiping, dripping and leaks. Pads are pre-cut absorbents, while rolls allow you to choose the length you need.

#### SOCs & Pillows

For use around equipment or under drips.



### Barrier-backed or Heavy Traffic Applications

#### Mats & Rugs

For use with heavy foot or vehicle traffic, or where a barrier-backed mat is needed.



### Emergency Spill Response

#### Spill Containment and Spill Kits

Specifically designed for emergency spills with a variety of products already bundled together.

Additional spill control products are available including spill pallets, drain plugs and absorbent storage centers.

## 3 Step Three: Select Your Absorbent Size and Weight



Now that you know what you're absorbing, and what style of product you need, you can choose your absorbent from the many sizes and absorbency weights that Brady SPC offers. Quickly and easily compare absorbents on the following pages.

### Perforations Guide

Perforated absorbents allow you to select the perfect size for your spill. Choose a small section for small spills, or a larger section for bigger spills. Our wide variety of size options results in less waste saving you money as you use only what you need.

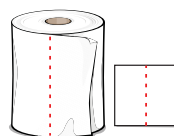

Single Perf

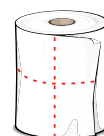

Double Perf

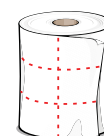

Triple Perf



# Universal Absorbents

BradyID.com/SPC

## Universal All-Purpose Absorbents

All-purpose absorbents for indoor use.

These all-purpose absorbents clean-up oils, coolants, solvents and water-based fluids anywhere in your facility. Around machinery, under leaky pipes or fittings, in messy traffic areas, for general maintenance projects – they are your first choice for indoor spill control. Plus, their gray color masks spills and stains – helping you resist the urge to pick up the absorbent before it's fully saturated.

Looking for added cost savings? Perforated absorbents encourage you to use only what you need.

**?** **Common Liquids Absorbed:**

- Coolants & Solvents
- Gasoline & Oil
- Latex paint
- And other water-based fluids

Absorbents and Spill Control



### BattleMat® Absorbents

- Ideal for areas with moderate foot traffic or as single use absorbents
- Camouflaged pattern hides absorbent stains reducing urge to dispose too early
- Universal 2-ply construction with a durable, abrasion-resistant upper layer

Catalog #	Type	Size	Qty.
<b>BattleMat Pads</b>			
BM100	Heavy Wt.	15"x19"	100
<b>BattleMat Rolls</b>			
BM30	Heavy Wt.*	30"x150'	1
BM30X	Heavy Wt.	30"x150'	1
BM15	Heavy Wt.*	15"x150'	1

\* Perforated

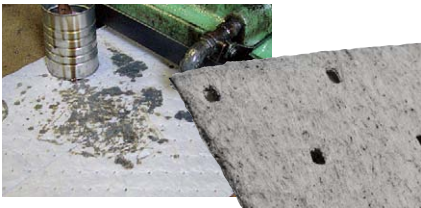

### MRO Plus® Absorbents

- All-purpose maintenance absorbent
- 3-ply (MMM) Meltblown Polypropylene increases durability and reduces lint

Catalog #	Type	Size	Qty.
<b>MRO Plus Pads</b>			
MRO50	Heavy Wt.*	30"x30"	50
MRO150DND	Heavy Wt.*	15"x19"	150
MRO100	Heavy Wt.*	15"x19"	100
MRO100-2	Heavy Wt.*	15"x19"	50
MRO300	Medium Wt.*	15"x19"	100
<b>MRO Plus Rolls</b>			
MRO30-DP	Heavy Wt.*	30"x150'	1
MRO30P	Heavy Wt.*	30"x150'	1
MRO30	Heavy Wt.	30"x150'	1
MRO24-DP	Heavy Wt.*	24"x150'	1
MRO15-DP	Heavy Wt.*	15"x150'	1
MRO15P	Heavy Wt.*	15"x150'	1
MRO15	Heavy Wt.	15"x150'	1
MRO15-DPS	Heavy Wt.*	15"x73'	1
MRO12P	Heavy Wt.*	12"x150'	1
MRO350-DP	Medium Wt.*	30"x150'	1
MRO350	Medium Wt.	30"x150'	1
MRO315P	Medium Wt.*	15"x150'	1

\* Perforated

\*MRO150DND has Dispense-n-Dispose™ System



### UXT - "Xtra Tough"

- Extra tough absorbents are abrasion resistant and low linting - perfect to wipe down tools and machinery
- Universal Meltblown Polypropylene
- 3-ply (SMS) construction with spunbond coverstock on both sides

Catalog #	Type	Size	Qty.
<b>UXT Pads</b>			
UXT100	Heavy Wt.*	15"x19"	100
UXT300	Medium Wt.*	15"x19"	100
UXT200	Light Wt.*	15"x19"	200
<b>UXT Rolls</b>			
UXT15P	Heavy Wt.*	15"x150'	1
UXT30DP	Medium Wt.*	30"x150'	1

\* Perforated



### GP - "General Purpose"

- MAXX® Technology improves adsorption without the extra weight
- Economical, single-ply general purpose absorbent
- Universal Meltblown Polypropylene

Catalog #	Type	Size	Qty.
<b>GP Pads</b>			
GP100	Heavy Wt.*	15"x19"	100
GP100-B	Heavy Wt.*	15"x19"	100
GP300	Medium Wt.*	15"x19"	100
GP200-B	Light Wt.*	15"x19"	200
GP500	Light Wt.*	15"x19"	100
MXU1000	Light Wt.*	15"x19"	100
<b>GP Rolls</b>			
GP30	Heavy Wt.	30"x150'	1

\* Perforated

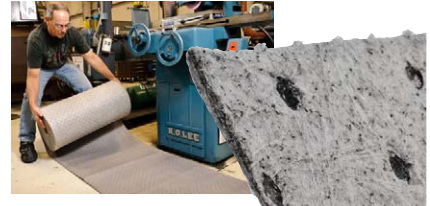

### HT - "High Traffic"

- Built for durability and high absorbency in "high traffic" areas
- Universal Meltblown Polypropylene
- 2-ply (SM) construction with spunbond coverstock

Catalog #	Type	Size	Qty.
<b>HT Pads</b>			
HT200	Light Wt.*	15"x19"	200
HT500	Light Wt.*	15"x19"	100
<b>HT Rolls</b>			
HT30	Heavy Wt.*	30"x150'	1
HT555	Heavy Wt.*	15"x150'	1
HT15	Heavy Wt.*	15"x150'	1
HT550	Heavy Wt.*	15"x50'	1
HT303	Medium Wt.*	30"x300'	1
HT303X	Medium Wt.*	30"x300'	1
HT350	Medium Wt.*	30"x150'	1
HT153	Medium Wt.*	15"x300'	1
HT230	Light Wt.*	30"x300'	1
HT215	Light Wt.*	15"x300'	1

\* Perforated

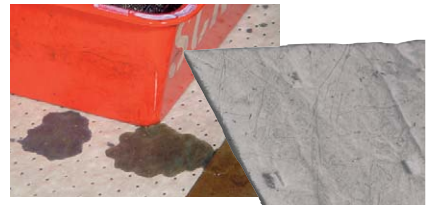

### Basic Universal

- Economical, single-ply all-purpose absorbent
- Universal Meltblown Polypropylene
- Perforated to reduce waste and dimpled for added durability

Catalog #	Type	Size	Qty.
<b>Basic Universal Pads</b>			
BPU100	Heavy Wt.*	15"x17"	100
BPU200	Light Wt.*	15"x17"	200
BPU500	Light Wt.*	15"x17"	100
<b>Basic Universal Rolls</b>			
BRU150	Heavy Wt.*	30"x150'	1
BRU152	Heavy Wt.*	15"x150'	2

\* Perforated

View full product specs on page 432.



## Re-Form™ Universal Absorbents:

Re-Form™ universal absorbents are made from a minimum of 80% recycled newsprint and other cellulose. These eco-friendly absorbents offer greater absorbency. In fact, they have been tested to be 25-50% more absorbent than oil-based polypropylene absorbents, so you'll use less product to get the job done.

*\*Re-Form™ Absorbents are not intended for use with highly aggressive chemicals.*

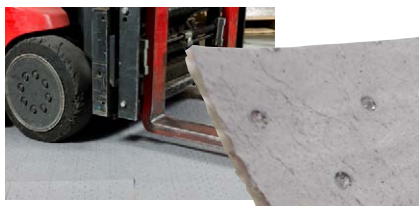

### Re-Form™ XPlus Absorbents

- Medium weight absorbent made from 80% recycled cellulose
- Up to 50% more absorbent than comparable meltblown polypropylene absorbents
- Meltblown coverstock on both sides provides better traction

Catalog #	Type	Size	Qty.
<b>Re-Form XPlus Pads</b>			
RFDP300	Medium Wt.*	15"x19"	100
<b>Re-Form XPlus Rolls</b>			
RFDP328DP	Medium Wt.*	28.5"x150'	1

\* Perforated



### Re-Form™ Pro Plus Absorbents

- Environmentally friendly: Made of 90% recycled materials
- Absorbs 20 times its weight
- Durable 3-ply dimpled construction

Catalog #	Type	Size	Qty.
<b>Re-Form Pro Plus Pads</b>			
RFPP100	Heavy Wt.*	15"x19"	100
<b>Re-Form Pro Plus Rolls</b>			
RFPP30P	Heavy Wt.*	30"x150'	1

\* Perforated



### Re-Form™ Plus Absorbents

- General purpose absorbent made from 80% recycled newsprint and cellulose
- Ideal for wiping and light foot traffic
- Spunbond coverstock on one side
- Class A fire retardant

Catalog #	Type	Size	Qty.
<b>Re-Form Plus Pads</b>			
RFP100	Heavy Wt.*	15"x19"	100
RFP500	Light Wt.*	15"x19"	100
<b>Re-Form Plus Rolls</b>			
RFP28-DP	Heavy Wt.*	28.5"x150'	1
RFP328-DP	Medium Wt.*	28.5"x150'	1
RFP314P	Medium Wt.*	14.25"x150'	1

\* Perforated



### Re-Form™ Absorbents

- Economical general purpose absorbent made from 80% recycled newsprint and cellulose
- Up to 50% more absorbent than comparable Meltblown Polypropylene absorbents
- Nylon mesh construction provides extra durability and strength
- Class A fire retardant

Catalog #	Type	Size	Qty.
<b>Re-Form Pads</b>			
RF100	Heavy Wt.*	15"x19"	100
RF300	Medium Wt.*	15"x19"	100
RF500	Light Wt.*	15"x19"	100

\* Perforated



### Spill Response Plus Universal Absorbents

- Convenient, portable size perfect for employees to fold or carry in their pockets for quick response time
- Ideal for small spills and janitorial applications
- Highly absorbent, multi-purpose absorbents designed to handle water-based liquids and oils
- Dimpled for added durability and reduced linting

Catalog #	Type	Size	Qty.
<b>Spill Response Plus Universal Pads</b>			
SRP200	Heavy Wt.	7.5"x10"	200
SRP100	Heavy Wt.	7.5"x10"	100
<b>Spill Response Plus Universal Roll</b>			
SRP75P	Heavy Wt.*	7.5"x50'	1

\* Perforated



### VendSorb™ Universal Absorbents

- Conveniently sized to fit into your vending program
- Highly absorbent, multi-purpose absorbents designed to handle water-based liquids and oils
- Reduce waste by using only what you need, dimpled for added durability

Catalog #	Type	Size	Qty.
<b>VendSorb™ Universal Rolls</b>			
VS12P	Heavy Wt.*	12"x60"	20
VS75P	Heavy Wt.*	7.5"x50"	20

\* Perforated

View full product specs on page 432.



# Oil Only Absorbents

BradyID.com/SPC

## Oil Only Absorbents

Oil absorbing and water repellent.

Specialized for oil and other petroleum-based spills, oil only pads and rolls will not absorb water and will float indefinitely. These absorbents are unaffected by temperature and impervious to rot and mildew. Ideal for outside use, Brady SPC's oil only products are equally effective in soaking up petroleum-based solvents and paints, vegetable oils and other non-water soluble oil-based fluids.

Looking for added cost savings? Select a perforated option that allows you to use only what you need.



### SXT® Oil Absorbents

- Dimpled absorbent with spunbond coverstock provides added durability with very low linting
- 3-ply (MMM) Meltblown Polypropylene construction

Catalog #	Type	Size	Qty.
<b>SXT Oil Pads</b>			
SXT100	Heavy Wt.*	15"x19"	100
SXT300	Medium Wt.*	15"x19"	100
SXT200	Light Wt.*	15"x19"	200
<b>SXT Oil Rolls</b>			
SXT30DP	Heavy Wt.*	30"x150'	1
SXT15P	Heavy Wt.*	15"x150'	1

\* Perforated



### ENV® Oil Absorbents

- Economical single-ply construction with MAXX® Technology - greater performance without the added weight
- Contractor grade Oil Only Meltblown Polypropylene

Catalog #	Type	Size	Qty.
<b>ENV Oil Pads</b>			
ENV100	Heavy Wt.	15"x19"	100
ENV50	Medium Wt.	30"x30"	50
ENV300	Medium Wt.	15"x19"	100
ENV200	Light Wt.	15"x19"	200
ENV500	Light Wt.	15"x19"	100
MXO1000	Light Wt.*	15"x19"	100
<b>ENV Oil Rolls</b>			
ENV150	Medium Wt.	30"x150'	1

\* Perforated



### Oil Plus Oil Absorbents

- Dimpled absorbent for general everyday use and emergency spill clean-up
- 3-ply (MMM) Meltblown Polypropylene construction

Catalog #	Type	Size	Qty.
<b>Oil Plus Pads</b>			
OP50	Heavy Wt.*	30"x30"	50
OP150DND	Heavy Wt.*	15"x19"	150
OP100	Heavy Wt.*	15"x19"	100
OP300	Medium Wt.*	15"x19"	100
<b>Oil Plus Rolls</b>			
OP30-DP	Heavy Wt.*	30"x150'	1
OP30P	Heavy Wt.*	30"x150'	1
OP30	Heavy Wt.	30"x150'	1
OP15-DP	Heavy Wt.*	15"x150'	1
OP15P	Heavy Wt.*	15"x150'	1
OP15	Heavy Wt.	15"x150'	1
OP15-DPS	Heavy Wt.*	15"x73"	1
OP550	Heavy Wt.*	15"x50'	1
OP350-DP	Medium Wt.*	30"x150'	1
OP315P	Medium Wt.*	15"x150'	1

\* Perforated

\*OP150DND has Dispense-n-Dispose™ System



### Basic Oil Absorbents

- Dimpled economical single-ply absorbents - great for everyday usage
- Single-ply Oil Only Meltblown Polypropylene

Catalog #	Type	Size	Qty.
<b>Basic Oil Pads</b>			
BPO100	Heavy Wt.*	15"x17"	100
BPO200	Light Wt.*	15"x17"	200
BPO500	Light Wt.*	15"x17"	100
<b>Basic Oil Rolls</b>			
BRO150	Heavy Wt.*	30"x150"	1
BRO152	Heavy Wt.*	15"x150'	2

\* Perforated



### Common Liquids Absorbed:

- Cutting fluids
- Hydraulic and brake fluids
- Engine oils
- Lubricants
- Cooking oils
- Gasoline and diesel
- Oil based paints and solvents
- And other oil-based fluids



### SPC® Oil Absorbents

- Dimpled absorbent made with MAXX® Technology - greater performance without the extra weight
- Convenient and cost-effective single-ply Oil Only Meltblown Polypropylene

Catalog #	Type	Size	Qty.
<b>SPC Oil Pads</b>			
SPC50	Heavy Wt.	33"x39"	50
SPC100	Heavy Wt.*	15"x19"	100
SPC100B	Heavy Wt. (Blue MBPP Pad)*	15"x19"	100
SPC105	Heavy Wt. (1 side w/ blue coverstock)*	15"x19"	100
SPC300	Medium Wt.*	15"x19"	100
SPC200	Light Wt.*	15"x19"	200
SPC500	Light Wt.*	15"x19"	100
<b>SPC Oil Rolls</b>			
SPC150	Heavy Wt.	38"x144'	1
SPC152	Heavy Wt.	19"x144'	2
SPC19150	Heavy Wt.	19"x144'	1
SPC156	Medium Wt. (1 side w/blue coverstock)*	30"x150'	1

\* Perforated



### Static Resistant Oil Absorbents

- Economical single-ply absorbents treated to resist static electricity build up
- Meets National Fire Protection Association (NFPA) specifications

Catalog #	Type	Size	Qty.
<b>Static Resistant Oil Pads</b>			
SR3625	Heavy Wt.	30"x30"	25
SR100	Heavy Wt.	15"x19"	100
SR1825	Medium Wt.	15"x19"	25
<b>Static Resistant Oil Rolls</b>			
SR3600	Heavy Wt.	30"x150'	1

\* Perforated

View full product specs on page 432.



## Re-Form™ Oil Only Absorbents

- Absorbs more than 34 times its weight in liquid
- 40% higher absorption ratio than the next leading absorbent
- Spunbond coverstock on both sides adds durability and reduces linting
- Made from 80% all natural cotton fibers
- Supports corporate sustainability and LEED initiatives

*Re-Form™ Absorbents are not intended for use with highly aggressive chemicals.*

Catalog #	Type	Size	Qty.
<b>Re-Form Oil Only Pads</b>			
RFODP100	Heavy Wt.*	15"x19"	100
<b>Re-Form Oil Only Rolls</b>			
RFOP28DP	Heavy Wt.*	28.5"x150'	1
RFOP14P	Heavy Wt.*	14.25"x150'	1

\* Perforated



## Spill Response Plus Oil Only Absorbents

- Convenient, portable size perfect for employees to fold or carry in their pockets for quick response time
- Ideal for small spills and janitorial applications
- Designed to absorb paints, vegetable oils and other non-water soluble oil-based fluids
- Dimpled for added durability and reduced linting

Catalog #	Type	Size	Qty.
<b>Spill Response Plus Oil Only Pads</b>			
SRPO200	Heavy Wt.	7.5"x10"	200
SRPO100	Heavy Wt.	7.5"x10"	100
<b>Spill Response Plus Oil Only Roll</b>			
SRPO75P	Heavy Wt.*	7.5"x50'	1

\* Perforated



## VendSorb™ Oil Only Absorbents

- Conveniently sized to fit into your vending program
- Absorbs petroleum-based oils, solvents and other non-water liquids
- Floats indefinitely even when saturated with oil
- Reduce waste by using only what you need, dimpled for added durability

Catalog #	Type	Size	Qty.
<b>VendSorb™ Oil Only Rolls</b>			
VSO12P	Heavy Wt.*	12"x60"	20
VSO75P	Heavy Wt.*	7.5"x50"	20

\* Perforated



### Watch Re-Form™ Absorbents In Action!

Re-Form™ absorbents have been tested to be up to 50% more absorbent than oil-based polypropylene absorbents, so you'll use less product to get the job done.

Watch the online videos at [BradyID.com/SPC](http://BradyID.com/SPC) to see for yourself!



# Absorbents and Spill Control

BradyID.com/SPC

## Chemical Absorbents

Color-coded absorbents for safe clean-up of hazardous fluids.

Alert employees to the presence of hazardous fluids with green and yellow chemical absorbents. These surfactant treated polypropylene pads and rolls can be used on a wide range of chemicals, and are chemically inert, so they will not react with aggressive fluids.

Looking for added cost savings? Select a perforated option that allows you to use only what you need.



**NEW!**

### High Visibility Safety Absorbents

- Get the benefits of a sign and an absorbent in one unique product
- Highly absorbent for all-purpose industrial applications
- Color and print make it ideal for areas where the risk of slips, trips and falls are greatest

Catalog #	Type	Size	Qty.
<b>High Visibility Safety Pads (with print)</b>			
CH100	Heavy Wt.*	15"x19"	100
CH200	Light Wt.*	15"x19"	200
<b>High Visibility Safety Pads (without print)</b>			
CH1212	Medium Wt.	12"X12"	200
CH1212-50	Medium Wt.	12"X12"	50
<b>High Visibility Safety Rolls (with print)</b>			
CH303	Medium Wt.*	30"x300'	1
CH30DP	Heavy Wt.*	30"x150'	1
CH15DP	Heavy Wt.*	15"x150'	1

\* Perforated



### Spill Response Plus Universal Plus Absorbents

- Small custom size reduces waste
- Highly absorbent, multi-purpose absorbents made to handle virtually any liquid
- Dimpled for added durability & reduced linting

Catalog #	Type	Size	Qty.
<b>Spill Response Plus Chemical Pads</b>			
SRPH200	Heavy Wt.	7.5"x10"	200
SRPH100	Heavy Wt.	7.5"x10"	100
<b>Spill Response Plus Chemical Roll</b>			
SRPH75P	Heavy Wt.*	7.5"x50"	1

\* Perforated



### Common Liquids Absorbed:

- Acids and bases
- Aggressive chemicals
- Oils
- Solvents
- Citric acid
- Water-based fluids
- Sodium hydroxide
- And other unknown chemicals



### Universal Plus Absorbents

- Dimpled and perforated green universal absorbent is chemically inert and ideal for aggressive fluids
- Universal Meltblown Polypropylene
- 3-ply construction makes it stronger, more durable and reduces lint

Catalog #	Type	Size	Qty.
<b>Universal Plus Chemical Pads</b>			
SPCUN1719	Medium Wt.*	15"x19"	100
SPCUN1113	Medium Wt.	12"x12"	200
SPCUN1113-50	Medium Wt.	12"X12"	50
<b>Universal Plus Chemical Roll</b>			
SPCUN3800	Medium Wt.*	30"x150'	1
SPCUN1019	Medium Wt.*	15"x150'	2

\* Perforated



### VendSorb™ Chemical Absorbents

- Conveniently sized to fit into your vending program
- Designed to absorb any liquids including oil and hazardous chemicals and acids
- Chemically inert making it ideal for aggressive fluids
- Reduce waste by using only what you need, dimpled for added durability

Catalog #	Type	Size	Qty.
<b>VendSorb™ Chemical Rolls</b>			
VSH12P	Heavy Wt.*	12"x60"	20
VSH75P	Heavy Wt.*	7.5"x50"	20

\* Perforated

View full product specs on page 432.



## High Performance Mats and Rugs

Combining absorbency with added durability features, Brady SPC's high performance mats and rugs are perfect for areas with heavy foot or forklift traffic. These specially designed absorbents help keep aisles and walkways slip-free by absorbing and containing oils, liquids and other solvents.

Compared to an entrance mat, absorbent mats and rugs offer better traction, reduce slipperiness and keep liquids from being tracked from one area to the next.

### Common Liquids Absorbed:

- Bases & Oils
- Chemicals
- Solvents
- Water-based fluids



### Barrier Backed High Visibility Mat

- Features the same construction as the chemical absorbent with non-slip, non-leak barrier backing for added durability
- Color and print make it ideal for areas with the risk of slips, trips and falls

Catalog #	Type	Size	Qty.
<b>High Visibility Pads</b>			
CHBB100	Heavy Wt.	15"x19"	100
<b>High Visibility Rolls</b>			
CHBB30	Heavy Wt.	30"x100'	1
CHBB15	Heavy Wt.	15"x100'	1



### HT "High Traffic" Barrier Backed Mat

- Feature HT construction with barrier backing for added absorbency and durability
- High-visibility safety printing provides visual warning at the point of need

Catalog #	Type	Size	Qty.
<b>HT High Traffic Pads</b>			
HTBB100	Heavy Wt.	15"x19"	100
<b>HT High Traffic Rolls</b>			
HTBB30	Heavy Wt.	30"x100'	1
HTBB15	Heavy Wt.	15"x100'	1



### Adhesive Absorbent Mat

- Adheres to any surface, reducing the likelihood of slips, trips and falls
- Removes without leaving any residue
- All-purpose mat for general industrial applications

Catalog #	Type	Size	Qty.
<b>Adhesive Mat Rolls</b>			
AD30100	Heavy Wt.	30"x100'	1
AD1500	Heavy Wt.	15"x100'	1



### TrackMat Matting

- Extremely durable 3-ply construction features UV-resistant top layer
- Highly absorbent polypropylene core
- Non-slip and non-leak barrier backing

Cat #	Type	Size	Qty.
<b>TrackMat Pads</b>			
TM30	Heavy Wt.	29"x29"	30
<b>TrackMat Rolls</b>			
TM58	Heavy Wt.	58"x80'	1
TM29	Heavy Wt.	29"x80'	1
TM19	Heavy Wt.	19"x80'	1



### Rag Rug Matting

- Eco-friendly absorbents made from recycled cotton and polyester fibers
- Highly absorbent, provides traction, and masks dirt
- Ideal for maintenance, repair and industrial environments

Cat #	Type	Size	Qty.
<b>Rag Rug Rolls</b>			
RAG36150	Heavy Wt.	36"x150'	1
RAG24150	Heavy Wt.	24"x150'	1
RAG1818	Heavy Wt.	18"x18"	50



### BSM - Barrier Spill Matting

- Industrial rug with non-slip and leak-proof barrier backing
- Needle-punched polypropylene is durable for high traffic areas
- Tear resistant and will not curl or buckle

Cat #	Type	Size	Qty.
<b>BSM Rolls</b>			
BSM300	Medium Wt.	36"x300'	1
BSM100	Medium Wt.	36"x100'	1
BSM3650	Medium Wt.	36"x50'	1



### SIR - Sorbent Industrial Rug

- Durable, needle-punched polypropylene fibers for high traffic areas
- Eliminates slippery areas and unsightly tracking
- Can stand up to most aggressive fluids

Cat #	Type	Size	Qty.
<b>SIR Rolls</b>			
SIR36	Heavy Wt.	36"x300'	1
SIR36150	Heavy Wt.	36"x150'	1
SIR72	Heavy Wt.	72"x150'	1

View full product specs on page 432.



# Absorbents and Spill Control

BradyID.com/SPC



## Absorbent SOCs, Pillows & Drum Covers

Specialty absorbent products including SOCs, pillows and drum covers can be used around a facility when a pad or roll may not be sufficient.

**SOCs:** Dependable, flexible tubes that mold around corners and conform to uneven surfaces to soak up spills and drips, preventing fluid from escaping to other areas.

**Pillows:** Ideal for use under the bottom of spill pallets or machines that are known to drip or leak.

**Drum Covers:** Eliminate the messy drips and overflow when mixing or pumping liquids from the drum barrel.



### ALLWIK® Universal SOCs

- All-purpose polypropylene SOC
- Suitable for most industrial applications
- Wringable and can be incinerated

Catalog #	Type	Size	Qty.
AW124	SOC	3"x12'	4
AW806	SOC	3"x8'	6
AW430	SOC	3"x4'	30
AW412	SOC	3"x4'	12



### SLIKWIK® Universal SOCs

- All-purpose corn cob-filled SOC
- Cost-effective option for picking up of all non-aggressive liquids

Catalog #	Type	Size	Qty.
SW46	SOC	3"x42"	40



### Cobra Coil® Universal SOCs

- All-purpose vermiculite-filled SOC
- Excellent for diking applications
- Suitable for all liquids including aggressive chemicals

Catalog #	Type	Size	Qty.
CC440V	SOC	3"x4'	40
CC400V	SOC	3"x4'	12



### BASIC Universal SOCs

- All-purpose cellulose-filled SOC
- Suitable for most non-aggressive fluids

Catalog #	Type	Size	Qty.
BSC40	SOC	3"x42"	40
BSC20	SOC	3"x42"	20



### Re-Form™ Universal SOCs

- Made from recycled newsprint and other cellulose
- Absorbs oils, coolants, solvents and water-based fluid

Catalog #	Type	Size	Qty.
MS-124	SOC	3"x12'	4
MS-806	SOC	3"x8'	6
MS-50	SOC	3"x4'	40
MS-412	SOC	3"x4'	12



### HAZWIK® SOCs

- Absorbs chemicals, acids and bases
- Flexible design is easily molded around spills

Catalog #	Type	Size	Qty.
HAZ124	SOC	3"x12'	4
HAZ412	SOC	3"x4'	12



## Re-Form™ Oil Only SOCs

- Made from 80% all natural cotton fibers
- Absorbs oil, grease, transmission fluid, coolant and other liquids.
- Repels water and floats for outdoor applications

Catalog #	Type	Size	Qty.
RFO412	SOC	3'x4'	12



## Oil Only SOCs

- Oil only polypropylene SOC
- Absorbs oil and petroleum based liquids while repelling water
- Wringable and can be incinerated

Catalog #	Type	Size	Qty.
OIL124	SOC	3'x12'	4
OIL806	SOC	3'x8'	6
OIL430	SOC	3'x4'	30
OIL412	SOC	3'x4'	12

**? SOC Usage Tips:**

Use these tips to help ensure that you get the most out of your SOCs:

- Clean-up all loose materials, rags and other debris around the spill
- SOCs work best when they lay flat against the floor
- Replace your SOC when liquid begins pooling or seeping underneath
- When installing your SOC, shake vigorously to evenly distribute absorbent within the SOC
- Overlap the ends of your SOC approximately 5" to extend your spill protection



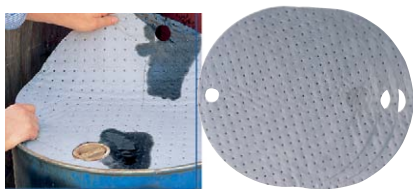

## ALLWIK® Universal Drum Covers

- All-purpose polypropylene drum cover
- Fits 55-gallon drums either with 1 or 2 bungholes
- Creates a clean and safe work floor by helping to prevent pump drips from reaching the floor

Catalog #	Type	Size	Qty.
DTA25	Medium Wt. Drum Cover	22" dia.	25



## Oil Only Drum Covers

- Oil only polypropylene drum cover
- Fits 55-gallon drums either with 1 or 2 bungholes
- Creates a clean and safe work floor by helping to prevent pump drips from reaching the floor

Catalog #	Type	Size	Qty.
DTO25	Medium Wt. Drum Cover	22" dia.	25



## ALLWIK® Universal Pillows

- All-purpose polypropylene pillow
- Suitable for most industrial applications
- Ideal for under valves and other dripping applications

Catalog #	Type	Size	Qty.
AW1818	Pillow	18"x18"	16
AW1818-2	Pillow	18"x18"	8
AW99	Pillow	9"x9"	32



## Oil Only Pillows

- Specialized oil only polypropylene will not absorb water or water-based liquids
- Ideal for use in waste troughs, coolant tanks, fluid reservoirs and sump wells

Catalog #	Type	Size	Qty.
OIL1818	Pillow	18"x18"	16
OIL1818-2	Pillow	18"x18"	8
OIL99	Pillow	9"x9"	32



## HAZWIK® Pillows

- Absorbs chemicals, acids and bases
- Ideal for extra protection during packaging and transport

Catalog #	Type	Size	Qty.
HAZ1818	Pillow	18"x18"	16
HAZ1818-2	Pillow	18"x18"	8
HAZ99	Pillow	9"x9"	32

View full product specs on page 432.



# Absorbents and Spill Control

BradyID.com/SPC



## Marine Absorbents

SPC marine specialty absorbents are designed to float on water and contain or absorb a wide variety of marine fuels and oils. From containment to booming and skimming operations, these absorbents will soak up unwanted fluids on lakes, rivers, streams and coastal shorelines. Marine absorbent products are made for high absorbency and rapid deployment in demanding emergency situations.

Absorbents and Spill Control



ENV510



SPC5510\*

## Absorbent Booms

- Premium SPC® Booms are lint free and easy to handle
- Economical ENV® booms feature a lint-free blue sleeve

Catalog #	Type	Size	Qty.
ENV810	ENV Boom	8"x10'	4
ENV510	ENV Boom	5"x10'	4
SPC810	SPC Boom	8"x10'	4
SPC510	SPC Boom	5"x10'	4
SPC5510	SPC Boom*	5"x10'	2
SPC818	SPC Boom	8"x18"	10
SPC518	SPC Boom	5"x18"	10
SPC318	SPC Boom	3"x18"	25

\* SPC5510 features two 5"x10' booms attached side by side.

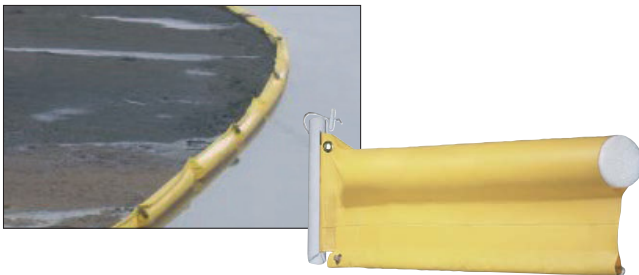

## Containment Booms

- Cost-effective solution for containment of oil spills on water
- Also used as barriers in holding ponds to retain waste and debris

Catalog #	Size	Qty.
CB612	6" Float, 12" Skirt, 100' Sections	1
CB305	3" Float, 4.5" Skirt, 25' Sections	1



## Marine Sweeps & Pillows

- 2-ply construction and durable blue coverstock for extra strength (for use with oil and petroleum-based fluids)
- "Sweep" the water to remove surface oil
- 100' sections are ideal for dragging behind or connecting between two ships

Catalog #	Type	Size	Qty.
SPC1900	Sweep	19"X100'	1
SPC10	Pillow	14"x25"	10



Available roped together or as individual nets.

## Oil Nets/Drag Nets

- Flat, chemical-resistant filaments in half-pound units float
- Reusable after draining or dousing with #1 or #2 weight oils; extracted oil can be recycled or downgraded as fuel oil
- Sweep between two boats or deployed along a shoreline

Catalog #	Type	Size	Qty.
ODN08	Oil Only	30 nets on 50' rope	1
ON030	Oil Only	30 nets (no rope)	1

View full product specs on page 432.



## Granular & Neutralizer Absorbents

Granular absorbents are loose, multi-purpose absorbents that are ideal for liquid spill clean-up, lab packing and stabilization of free liquids. These absorbents are ideal for facilities that prefer or require the use of traditional granular absorbents.

Neutralizing polymers provide safe spill control for most acids, including battery spills. Color change indicates when neutralization has taken place.



### Re-Form™ Industrial Absorbent

- 100% recycled material, safe for the environment and employee use
- Absorbs oils, solvents, lubricants, water and most non-aggressive liquids on contact
- 1:1 absorbency ratio - absorbs its own weight

Catalog #	Size	Qty.
RFGRANULAR	30 lb bag	65/pallet



### SPC Granular Absorbent

- All natural corn cob product for oil, grease, water and other liquids
- Ideal for use in aircraft maintenance, machine shops, food processing, filling lines and bulk liquid transfer stations
- Not for aggressive fluids

Catalog #	Size	Qty.
DZ-100	40 lb bag	40/pallet



### Cansorb Oil Only Granular Absorbent

- All-organic oil only absorbent, made from high quality fiber sphagnum peat moss
- Ideal for oil only clean-up on open water and land applications
- Absorbs 8 times its weight

Catalog #	Size	Qty.
CS-CB18	18 lb bag	50/pallet
CS-LFB10	10 lb bag	64/pallet

**Request a Free Absorbents Sample Pack to try in your facility.**

Visit [BradyID.com/SPC](http://BradyID.com/SPC) to request a free SPC Absorbent Sample Pack and see what SPC absorbents can do for you!



### Oil Gator Granular

- All natural biodegradable absorbent captures 2-6 times its weight in oil
- Will not harm environment and stops leaching of contaminants into the soil and groundwater

Catalog #	Size	Qty.
GS-10	30 lb bag	60/pallet



### Acid & Base Neutralizing Polymer

- Acid neutralizer provides safe spill control for most acids (including battery spills)
- Base neutralizer used for most bases
- Color change indicates neutralization
- Non-toxic, non-corrosive and non-hazardous

Catalog #	Size	Qty.
SPC-ACID	2 lb bottle	1 each*
SPC-BASE	2 lb bottle	1 each*

\*Minimum order of 10 required.



# Spill Control & Containment

BradyID.com/SPC

Absorbents and Spill Control

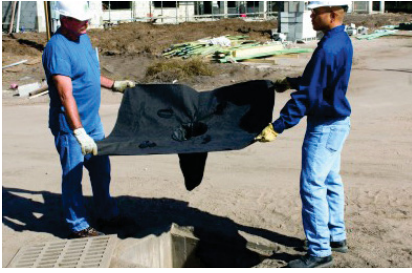

## Storm Drain Guards

- Keeps oil, sediment and contaminants from entering water system
- Holds up to 40 lbs of sediment; flow rate is 500 gpm (new) and 700 gpm bypass

Catalog #	Size	Qty.
DGUARD14	36"x48"x18"	1*
DGUARD1410	36"x48"x18"	10*
DGUARD9	36"x48"x18"	1
DGUARD910	36"x48"x18"	10

\* Feature X-TEX filter strips



## Steel Spill Deck

- 100% galvanized steel containment pallets with fork lift pockets for easy transport
- Nestable construction reduces facility footprint

Catalog #	Description	Size	Qty.
SS-2DR	2-Drum Steel Spill Deck	47.5"x31.5"x17"	1
SS-4DR	4-Drum Steel Spill Deck	47.5"x47.5"x13.26"	1



## Spill Decks

- Contain hazardous leaks with these low profile, 21.2-gallon capacity, two-drum spill decks
- Built-in clips easily connect multiple decks – creating a 4, 6, 8 or more drum storage platform

Catalog #	Type	Size	Qty.
SC-SD2	2-Drum Spill Deck	26"x52"x6"	1
SC-DK	Sump Drain Kit to share capacity across decks		1



## Drain Plugs

- Conical-shaped drain plugs made from chemical-resistant PVC keep spills from entering the drains
- Just rinse and re-use when finished

Catalog #	Description	Size	Qty.
PLUG6	Drain Plug	6" Plug	1
PLUG4	Drain Plug	4" Plug	1
PLUG3	Drain Plug	3" Plug	1
PLUG2	Drain Plug	2" Plug	1



## Oil Skimming System

- Compact oil skimming system designed for vertical recover of floating oils in settling ponds or sumps
- Compact oil skimming system for industrial applications requiring up to 30 ft. mop and up to 100 gallon/hour recovery rates

Catalog #	Description	Size	Qty.
MW-13	Stainless Steel Oil Skimming System	13"x14"x22"	1



\*Easy loading ramp sold separately.

## Spill Pallets

- Comply with governmental secondary containment regulations
- Capacity up to 128.9 gallons of containment
- 2-drum or 4-drum configuration

Catalog #	Type	Size	Qty.
SC-DP4	4-Drum Spill Pallet	52"x52"x17"	1
SC-DP2	2-Drum Spill Pallet	26"x52"x17"	1
SC-DPR	Spill Pallet Ramp	32.5"x70"	1



SLIKSTOPPER  
PVC Drain Seal

Spill Magnet™  
Drain Seal

## Drain Seals

- Clean-up with soap and water for re-use
- SLIKSTOPPER's flexible and chemical-resistant PVC tightly seals drains
- Spill Magnets are backed with a strong magnet to seal drains

Catalog #	Description	Size	Qty.
PVC42	Slikstopper	42"x42"	1
PVC36	Slikstopper	36"x36"	1
PVC24	Slikstopper	24"x24"	1
PVC18	Slikstopper	18"x18"	1
96229	Magnet	12" dia.	1



## Drip Pans

- Durable, low profile, polyethylene drip pans easily fit under leaky drum spigots and other problem areas
- Pan and universal fill captures up to 3/4 of a gallon of liquid

Catalog #	Description	Size	Qty.
DPA24	Drip Pan	10"x10"	24



## Spill Berms

- Standard and lightweight available
- Self contained containment systems feature a one-piece design
- Requires no assembly, tools or inflation

Catalog #	Type	Size	Qty.
SB-1236	Standard Spill Berm	12"x36"x1'	1
SB-1226	Standard Spill Berm	12"x26"x1'	1
SB-1212	Standard Spill Berm	12"x12"x1'	1
SB-1010	Standard Spill Berm	10"x10"x1'	1
SB-SL46	Lightweight Spill Berm	4'x6'x8"	1
SB-SL44	Lightweight Spill Berm	4'x4'x8"	1

View full product specs on page 432.

## Spill Containment and Storage

A proper spill containment plan can help create a safe and productive work environment for your employees. SPC spill containment products help to prepare and protect any facility with solutions for unexpected, critical accidents. Absorbent storage centers and SPC spill kits provide fast-response solutions for unplanned spills of oils, solvents, coolants and other fluids. SPC drains, spill decks, berms, pans and pallets also ensure facility safety by catching, controlling and containing unexpected leaks, drips and spills.

This absorbent center's modular cabinet is designed to hold all of your essential absorbents for storage and easy access - so your spill response team can quickly grab the right absorbent for the job. With the ability to hold full cases of SPC absorbent products, there is no special refill required for restocking. Also, because it's modular, customizable and mobile, the size of your absorbent storage is entirely up to you.



\* Absorbents sold separately.

### Absorbent Centers

- Fill with just about any SPC absorbent you need
- Use as an absorbent deployment station or mobile spill control unit
- Holds up to a 38" roll and full bales of product – no special refills required!
- Stack two or three to make a cabinet, hang it on the wall, or place it under your workbench
- Optional casters, wall mounting bracket, dowel rods and an accessory pack also available



Set Of Casters



15" or 40" Dowel Rods



Accessory Pack (goggles, gloves, disposal bags with ties and an emergency handbook)



Wall Mount

Catalog #	Description	Size	Qty.
SC-3000	Absorbent Center without casters	50"L X 26"W X 7.75"H	1 each
SC-ACC	Accessory Pack	Includes goggles, gloves, disposal bags with ties, and an emergency handbook.	1 pack
SC-D15	15" Dowel Rod	15"	1 rod
SC-D40	40" Dowel Rod	40"	1 rod
SC-4	Set of 4 casters	n/a	1 pack
SC-MB	Wall Mount	n/a	1 each



### Spill Control Cart

- Secure storage with locking handle (2 keys included)
- Convenient sturdy work surface with one fixed interior shelf
- 3" backstop on top surface
- Tubular handle and wheels for ease of mobility
- Extremely durable 16 gauge all welded steel

Catalog #	Description	Size	Qty.
SC-Cart	Spill Control Cart	36 x 18 x 38-3/8	1/each

Absorbents sold separately



### Spill Control Cabinet

- Allows easy access for emergency situations
- 2 fully adjustable shelves included
- Durable construction and keyhole slots for wall hanging
- Plexiglas window allows for easy content inventory

Catalog #	Description	Size	Qty.
SC-Cabinet	Spill Control Cabinet	19-7/8 x 14-1/4x 32-3/4	1/each

Absorbents sold separately

View full product specs on page 432.



# Absorbent Spill Kits

BradyID.com/SPC



## Absorbent Spill Kits

Accidents do happen, so it's better to be prepared.

Brady offers a complete selection of SPC spill kits in a variety of types and sizes to equip you with everything you need to clean-up accidents when they happen. Quickly and easily clean-up spills of oils, solvents, coolants and other fluids. They are ideal for fast response to critical accidents.

Many of our kits are available in the following types:

- **Universal/Maintenance Kits:** All-purpose absorbents for oil, water-based and chemical liquids
- **Oil Only Spill Kits:** Water repellent absorbents for oil and petroleum-based liquids
- **Chemical Spill Kits:** Absorbents for aggressive and hazardous liquids
- **Re-Form™ Spill Kits:** Universal absorbents that are eco-friendly
- **TAA Compliant Spill Kits:** Complies with the Trade Agreements Act
- **Mixed Application Spill Kits:** Ideal for indoor and outdoor applications. Kits contain both all-purpose universal absorbents and water-repellent oil only absorbents for petroleum and oil-based liquids

### Spill Kits Increase Efficiency

Worker productivity and efficiencies can be improved dramatically by placing spill kits or absorbent storage centers strategically around the facility and closer to the areas of need. For both emergency response and routine maintenance and safety, you don't want employees wandering away from their workstation to the other side of the plant or tool room to find the absorbent materials they need.



Be prepared: make sure you have spill kits on hand throughout your facility!



Shipping Docks



Freight Vehicles



Maintenance Areas



Plant Floor



### Spill Procedure Guide: What To Do When A Spill Occurs

- 1. Risk Assessment**  
Evaluate the type of material spilled and identify the source. If you are NOT familiar with the liquid and its chemical properties, vacate the area and contact proper authorities.
- 2. Protective Clothing**  
Wear the appropriate protective gear for the situation. If the source or the material is not identifiable, assume the worst.
- 3. Containment**  
Contain the liquid and seal drains.
- 4. Stop the Source**  
Close valves, rotate punctured drums and plug leaks where it is possible and safe to do so.
- 5. Begin Clean Up**  
Use SPC absorbents to absorb spilled liquids.
- 6. Contact Authorities**  
Report the spill to proper legal authorities in your community. Be sure to fill out all necessary reports in accordance with local laws.
- 7. Disposal of Used Material**  
Absorbent materials take on the characteristics of whatever they absorb. Be sure to dispose of used absorbents and spilled liquids in accordance with local laws.
- 8. Decontaminate**  
Clean all tools and reusable materials properly before reuse.
- 9. Restock Materials**  
Replace absorbent materials and safety equipment used in any clean-up operation.
- 10. Review Contingency Plans and Procedures!**

View full product specs on page 432.





## MAXX® Packs

- Mini-packs in re-sealable zipper bags
- 20 economic, single ply pads
- Dimensions: 15.5"L x 19.5"W x 20.5"H
- Contents:
  - 20 pads (15" x 19")

Catalog #	Type	Qty.
MXP-U20	Universal	5
MXP-O20	Oil Only	5
MXP-C20	Chemical	5



## Economy Spill Kit

- Highly visible yellow PVC bag for small spills; the right price, the right size and the right value
- Absorbs up to 5 gallons per kit
- Dimensions: 20"L X 16"W X 4"H
- Contents:
  - 10 pads (15" x 19")
  - 2 SOC's (3" x 4')
  - 1 disposal bag
  - 1 pair nitrile gloves
  - 1 instruction sheet

Catalog #	Type	Qty.
SKA-PP	Universal	1
SKA-PP-TAA	Universal	1
SKO-PP	Oil Only	1
SKH-PP	Chemical	1
SKR-PP	Re-Form	1



## 2-Gallon Spill Response Plus Retail Spill Kit

- Small sized absorbents are highly absorbent, durable and low linting
- Ideal for hospitality, retail, restaurants or anywhere that requires a small pad
- Absorbs up to 4.5 gallons per kit
- Dimensions: 9.75"Dia. X 10.5"H
- Contents:
  - 20 pads (7.5" x 10")
  - 1 pair nitrile gloves
  - 1 disposal bag
  - 1 instruction sheet
  - 1 pair goggles

Catalog #	Type	Qty.
SKA-SRP	Universal	1
SKO-SRP	Oil Only	1
SKH-SRP	Chemical	1



## 6.5-Gallon Acid Neutralizer Spill Kit

- Used to solidify a wide range of acid spills
- Polymers will neutralize and change to a purple color to let you know neutralization has taken place
- Absorbs up to 4.5 gallons per kit
- Dimensions: 14"Dia. X 18"H
- Contents:
  - 6.5 gallon bucket
  - 1 shaker of acid neutralizer (2 lb.)
  - 10 pads (15" x 19")
  - 2 SOC's (3" x 4')
  - 2 disposal bags
  - 1 pair goggles
  - 1 pair nitrile gloves
  - 1 Tyvek Suit
  - 1 small scoop

Catalog #	Type	Qty.
SKA-BKTACID	Acid Neutralizer	1



## 6.5-Gallon Base Neutralizer Spill Kit

- Used to solidify a wide range of base spills
- Polymers will neutralize and change to an orange color to let you know neutralization has taken place
- Absorbs up to 4.5 gallons per kit
- Dimensions: 14"Dia. X 18"H
- Contents:
  - 6.5 gallon bucket
  - 1 shaker of base neutralizer (2 lb.)
  - 10 pads (15" x 19")
  - 2 SOC's (3" x 4')
  - 2 disposal bags
  - 1 pair goggles
  - 1 pair nitrile gloves
  - 1 Tyvek Suit
  - 1 small scoop

Catalog #	Type	Qty.
SKA-BKTBASE	Base Neutralizer	1



## 6.5-Gallon Spill Bucket

- Fast and small response with easily accessible spill kit in a reusable bucket
- Absorbs up to 10 gallons per kit
- Dimensions: 14"Dia. X 18"H
- Contents:
  - 10 pads (15" x 19")
  - 3 SOC's (3" x 4')
  - 2 disposal bags
  - 1 pair nitrile gloves
  - 1 instruction sheet

Catalog #	Type	Qty.
SKA-BKT	Universal	1
SKA-BKT-TAA	Universal	1
SKO-BKT	Oil Only	1
SKH-BKT	Chemical	1



# Absorbent Spill Kits

BradyID.com/SPC



## Attack Pac Spill Kit

- Space saving, single use kit, packed in puncture and UV resistant foil bag (includes grommet for hanging)
- Absorbs up to 7 gallons per kit
- Dimensions: 20"L X 16"W X 4"H
- Contents:
  - 15 pads (15" x 19")
  - 3 SOCs (3" x 4')
  - 1 disposal bag
  - 1 pair goggles
  - 1 pair nitrile gloves
  - 1 instruction sheet

Catalog #	Type	Qty.
SKA-ATK	Universal	4
SKA-ATK-TAA	Universal	4
SKO-ATK	Oil Only	4
SKH-ATK	Chemical	4
SKR-ATK	Re-Form	4



## Emergency Spill Sak

- Easily portable economy spill kit packed in a reusable sack
- Absorbs up to 9 gallons per kit
- Dimensions: 32"L X 20"W X 12"H
- Contents:
  - 10 pads (15" x 19")
  - 2 SOCs (3" x 12')
  - 1 pillow (17" x 19")
  - 1 disposal bag
  - 1 pair nitrile gloves
  - 1 instruction sheet

Catalog #	Type	Qty.
SKA-SAK	Universal	1
SKO-SAK	Oil Only	1
SKH-SAK	Chemical	1



## Emergency Response Kit

- Quickly assess the absorbents you have through the clear shoulder bag when you respond to the spill
- Absorbs up to 15 gallons per kit
- Dimensions: 25.5"L x 17"W x 21.5"H
- Contents:
  - 32 pads (15" x 19")
  - 5 SOCs (3" x 12')
  - 1 pillow (17" x 19")
  - 2 disposal bags
  - 1 pair goggles
  - 1 pair nitrile gloves
  - 1 instruction sheet

Catalog #	Type	Qty.
SKA-CFB	Universal	1
SKA-CFB-TAA	Universal	1
SKO-CFB	Oil Only	1
SKH-CFB	Chemical	1



BASIC Vehicle Spill Kit

## Basic Vehicle Spill Kit

- Mobile, compact emergency kit for fast spill response
- Easily fits in your truck, cab or storage
- Universal and oil only products allow kit to be used for mixed fluid applications
- Available in a clear economical portable bag
- Absorbs up to 7.75 gallons per kit
- Contents:
  - 10 oil only pads (15" x 19")
  - 10 universal pads (15" x 19")
  - 2 SOCs (3"x 42")
  - 1 putty
  - 1 set of nine plugs
  - 2 disposable bags
  - 1 pair of goggles
  - 1 pair of nitrile gloves

Catalog #	Type	Qty.
BSCSK-CB	BASIC Vehicle Spill Kit	1



Camouflaged Vehicle Spill Kit

## Camouflaged Vehicle Spill Kit

- Mobile, compact emergency kit for fast spill response
- Easily fits in your truck, cab or storage
- Universal and oil only products allow kit to be used for mixed fluid applications
- Available in a durable camouflaged portable bag
- Absorbs up to 11.5 gallons per kit
- Contents:
  - 20 oil only pads (15" x 19")
  - 10 universal pads (15" x 19")
  - 3 SOCs (3"x 42")
  - 1 putty
  - 1 set of nine plugs
  - 2 disposable bags
  - 1pair of nitrile gloves
  - 1 pair of goggles

Catalog #	Type	Qty.
SK-CAMO	Camouflaged Vehicle Spill Kit	1



Camouflaged Vehicle Spill Kit with RuptureSEAL

## Camouflaged Vehicle Spill Kit with RuptureSEAL

- Mobile, compact emergency kit for fast spill response
- Easily fits in your truck, cab or storage
- Available in a durable camouflaged portable bag
- Absorbs up to 11.5 gallons per kit
- Contents:
  - 20 oil only pads (15" x 19")
  - 10 universal pads (15" x 19")
  - 1 set of 3 RuptureSEAL (1", 2.5", 2"x6")
  - 3 SOCs (3"x 42")
  - 2 disposal bags
  - 1pair of nitrile gloves
  - 1 pair of goggles

Catalog #	Type	Qty.
SK-CAMO-RS	Camouflaged Vehicle Spill Kit with RuptureSEAL	1

View full product specs on page 432.



## 20-Gallon Lab Pack

- UN-approved water and chemical resistant polyethylene container with screw top lid for small-medium response
- Absorbs up to 17 gallons per kit
- Dimensions: 21"Dia. X 18"H
- Contents:
  - 12 pads (15" x 19")
  - 3 SOCs (3" x 12")
  - 2 pillows (18" x 18")
  - 3 disposal bags
  - 1 pair goggles
  - 1 pair nitrile gloves
  - Emer. Response Guidebook

Catalog #	Type	Qty.
SKA-20	Universal	1
SKA20-TAA	Universal	1
SKO-20	Oil Only	1
SKH-20	Chemical	1
SKR-20	Re-Form	1



## Mobile Spill Kaddie

- Mobile, compact emergency kit for fast spill response anywhere in the plant
- Absorbs up to 22 gallons per kit
- Dimensions: 18"L X 17"W X 39"H
- Contents:
  - 1 roll (15" x 73")
  - 5 SOCs (3" x 4")
  - 8 pillows (10" x 10")
  - 5 disposal bags
  - 1 pair goggles
  - 1 pair nitrile gloves
  - Emer. Response Guidebook

Catalog #	Type	Qty.
SKA-K2	Universal	1
SKO-K2	Oil Only	1
SKH-K2	Chemical	1

View full product specs on page 432.



## 20-Gallon Mixed Application Kit

- A single spill kit to respond to spills of water based fluids AND petroleum based spills
- Absorbs up to 15 gallons per kit
- Dimensions: 21"Dia. X 18"H
- Contents:
  - 6 universal pads (15"x19")
  - 6 oil only pads (15"x19")
  - 1 universal pillow (18"x18")
  - 1 oil only pillow (18"x18")
  - 3 disposal bags
  - 1 pair goggles
  - 1 pair nitrile gloves
  - Emer. Response Guidebook

Catalog #	Type	Qty.
SKMA-20	Mixed	1



## 30-Gallon Spill Kit

- Tough, secure, screw-topped spill kit is reusable and ideal for small-medium responses
- Absorbs up to 36 gallons per kit
- Dimensions: 21.125"Dia. X 28.5"H
- Contents:
  - 25 pads (15" x 19")
  - 6 SOCs (3" x 12")
  - 6 pillows (9" x 9")
  - 3 disposal bags
  - 1 pair goggles
  - 1 pair nitrile gloves
  - Emer. Response Guidebook

Catalog #	Type	Qty.
SKA30	Universal	1
SKA30-TAA	Universal	1
SKO30	Oil Only	1
SKH30	Chemical	1



## 20-Gallon RESCUE™ Kit

- "Caution" tape and a "Wet Floor" sign help prevent slips, trips and falls while a spill is being cleaned up
- Absorbs up to 15 gallons per kit
- Dimensions: 21"Dia. X 18"H
- Contents:
  - 12 pads (15" x 19")
  - 3 SOCs (3" x 12")
  - 2 pillows (18" x 18")
  - 3 disposal bags
  - 1 pair goggles
  - 1 pair nitrile gloves
  - Emer. Response Guidebook
  - 1 roll caution tape (3" x200")
  - 1 wet floor sign (18")
  - Emer. Response Guidebook

Catalog #	Type	Qty.
SKA-20-RESCUE	Universal	1
SKO-20-RESCUE	Oil Only	1
SKH-20-RESCUE	Chemical	1



## 30-Gallon Mixed Application Kit

- A single spill kit to respond to spills of water based fluids AND petroleum based spills
- Absorbs up to 36 gallons per kit
- Dimensions: 21.125"Dia. X 28.5"H
- Contents:
  - 15 universal pads (15"x19")
  - 10 oil only pads (15"x19")
  - 3 universal SOCs (3" x 12")
  - 3 oil only SOCs (3" x 12")
  - 3 universal pillows (9"x9")
  - 3 oil only pillows (9"x9")
  - 3 disposal bags
  - 1 pair goggles
  - 1 pair nitrile gloves
  - Emer. Response Guidebook

Catalog #	Type	Qty.
SKMA-30	Mixed	1



# Absorbent Spill Kits

BradyID.com/SPC



## 55-Gallon Drum

- Lever locked 55-gallon drum meets UN specs and is ideal for medium spills
- Absorbs up to 38 gallons per kit
- Dimensions: 24"Dia. X 37"H
- Contents:
  - 50 pads (15" x 19")
  - 4 SOCs (3" x 12")
  - 8 pillows (18" x 18")
  - 5 disposal bags
  - 1 pair goggles
  - 1 pair nitrile gloves
  - Emer. Response Guidebook

Catalog #	Type	Qty.
SKA-55	Universal	1
SKA55-TAA	Universal	1
SKO-55	Oil Only	1
SKH-55	Chemical	1
SKR-55	Re-Form	1



## 55-Gallon Kit With Wheels

- Portable wheeled spill kit is ideal for medium spills
- Absorbs up to 38 gallons per kit
- Dimensions: 24"Dia. X 37"H
- Contents:
  - 50 pads (15" x 19")
  - 4 SOCs (3" x 12")
  - 8 pillows (18" x 18")
  - 5 disposal bags
  - 1 pair goggles
  - 1 pair nitrile gloves
  - Emer. Response Guidebook

Catalog #	Type	Qty.
SKA-55W	Universal	1
SKO-55W	Oil Only	1
SKH-55W	Chemical	1



## 55-Gallon Mixed Application Kit

- A single spill kit to respond to spills of water based fluids AND petroleum based spills
- Absorbs up to 38 gallons per kit
- Dimensions: 24"Dia. X 37"H
- Contents:
  - 25 universal pads (15"x19")
  - 25 oil only pads (15"x19")
  - 2 universal SOCs (3" x 12")
  - 2 oil only SOCs (3" x 12")
  - 4 universal pillows (18"x18")
  - 4 oil only pillows (18"x18")
  - 5 disposal bags
  - 1 pair goggles
  - 1 pair nitrile gloves
  - Emer. Response Guidebook

Catalog #	Type	Qty.
SKMA-55	Mixed	1



## 55-Gallon Mixed Application Kit With Wheels

- Portable wheeled spill kit for spills of water based fluids AND petroleum based spills
- Absorbs up to 38 gallons per kit
- Dimensions: 24"Dia. X 37"H
- Contents:
  - 25 universal pads (15"x19")
  - 25 oil only pads (15"x19")
  - 2 universal SOCs (3" x 12")
  - 2 oil only SOCs (3" x 12")
  - 4 universal pillows (18"x18")
  - 4 oil only pillows (18"x18")
  - 5 disposal bags
  - 1 pair goggles
  - 1 pair nitrile gloves
  - Emer. Response Guidebook

Catalog #	Type	Qty.
SKMA-55W	Mixed	1



## 65-Gallon Spill Kit

- Tough, secure, screw-topped spill kit is reusable and ideal for medium-large spill responses
- Absorbs up to 63 gallons per kit
- Dimensions: 31"Dia. X 33.5"H
- Contents:
  - 100 pads (15" x 19")
  - 7 SOCs (3" x 12")
  - 7 pillows (18" x 18")
  - 5 disposal bags
  - 1 pair goggles
  - 1 pair nitrile gloves
  - Emer. Response Guidebook

Catalog #	Type	Qty.
SKA65	Universal	1
SKA65-TAA	Universal	1
SKO65	Oil Only	1
SKH65	Chemical	1



## 65-Gallon Kit With Wheels

- Portable wheeled spill kit for spills of water based fluids AND petroleum based spills
- Absorbs up to 63 gallons per kit
- Dimensions: 31"Dia. X 33.5"H
- Contents:
  - 100 pads (15" x 19")
  - 7 SOCs (3" x 12")
  - 7 pillows (18" x 18")
  - 5 disposal bags
  - 1 pair goggles
  - 1 pair nitrile gloves
  - Emer. Response Guidebook

Catalog #	Type	Qty.
SKA-65W	Universal	1
SKO-65W	Oil Only	1
SKH-65W	Chemical	1

View full product specs on page 432.



## 65-Gallon Mixed Application Kit

- A single spill kit to respond to spills of water based fluids AND petroleum based spills
- Absorbs up to 63 gallons per kit
- Dimensions: 31"Dia. X 33.5"H
- Contents:
  - 50 universal pads (15"x19")
  - 50 oil only pads (15"x19")
  - 4 universal SOCs (3" x 12')
  - 3 oil only SOCs (3" x 12')
  - 4 universal pillows (18"x18")
  - 3 oil only pillows (18"x18")
  - 5 disposal bags (15"x19")
  - 1 pair goggles
  - 1 pair nitrile gloves
  - Emer. Response Guidebook

Catalog #	Type	Qty.
SKMA-65	Mixed	1



## 65-Gallon Mixed Application Kit With Wheels

- Portable wheeled spill kit for spills of water based fluids AND petroleum based spills
- Absorbs up to 63 gallons per kit
- Dimensions: 31"Dia. X 33.5"H
- Contents:
  - 50 universal pads (15"x19")
  - 50 oil only pads (15"x19")
  - 4 universal SOCs (3" x 12')
  - 3 oil only SOCs (3" x 12')
  - 4 universal pillows (18"x18")
  - 3 oil only pillows (18"x18")
  - 5 disposal bags (15"x19")
  - 1 pair goggles
  - 1 pair nitrile gloves
  - Emer. Response Guidebook

Catalog #	Type	Qty.
SKMA-65W	Mixed	1



## 95-Gallon Overpack

- Tough, secure, screw-topped kit for large spills meets UN and DOT specs
- Absorbs up to 75 gallons per kit
- Dimensions: 31.5"Dia. X 35"H
- Contents:
  - 110 pads (15" x 19")
  - 12 SOCs (3" x 4')
  - 8 SOCs (3" x 12')
  - 8 pillows (18" x 18")
  - 10 disposal bags
  - 1 pair goggles
  - 1 pair nitrile gloves
  - Emer. Response Guidebook

Catalog #	Type	Qty.
SKA-95	Universal	1
SKO-95	Oil Only	1
SKH-95	Chemical	1
SKR-95	Re-Form	1



## 95-Gallon Kit With Wheels

- Portable wheeled spill kit is ideal for large spills
- Absorbs up to 75 gallons per kit
- Dimensions: 31.5"Dia. X 35"H
- Contents:
  - 110 pads (15" x 19")
  - 12 SOCs (3" x 4')
  - 8 SOCs (3" x 12')
  - 8 pillows (18" x 18")
  - 10 disposal bags
  - 1 pair goggles
  - 1 pair nitrile gloves
  - Emer. Response Guidebook

Catalog #	Type	Qty.
SKA-95W	Universal	1
SKO-95W	Oil Only	1
SKH-95W	Chemical	1



## 95-Gallon Mixed Application Kit

- A single spill kit to respond to spills of water based fluids AND petroleum based spills
- Absorbs up to 75 gallons per kit
- Dimensions: 31.5"Dia. X 35"H
- Contents:
  - 55 universal pads (15"x19")
  - 55 oil only pads (15"x19")
  - 6 universal SOCs (3" x 4')
  - 6 oil only SOCs (3" x 4')
  - 4 universal SOCs (3" x 12')
  - 4 oil only SOC (3" x 12')
  - 4 universal pillows (18"x18")
  - 4 oil only pillows (18"x18")
  - 4 oil only pillows (15"x19")
  - 10 disposal bags
  - 1 pair goggles
  - 1 pair nitrile gloves
  - Emer. Response Guidebook

Catalog #	Type	Qty.
SKMA-95	Mixed	1



## 95-Gallon Mixed Application Kit With Wheels

- Portable wheeled spill kit for spills of water based fluids AND petroleum based spills
- Absorbs up to 75 gallons per kit
- Dimensions: 31.5"Dia. X 35"H
- Contents:
  - 55 universal pads (15"x19")
  - 55 oil only pads (15"x19")
  - 6 universal SOCs (3" x 4')
  - 6 oil only SOCs (3" x 4')
  - 4 universal SOCs (3" x 12')
  - 4 oil only SOC (3" x 12')
  - 4 universal pillows (18"x18")
  - 4 oil only pillows (18"x18")
  - 4 oil only pillows (15"x19")
  - 10 disposal bags
  - 1 pair goggles
  - 1 pair nitrile gloves
  - Emer. Response Guidebook

Catalog #	Type	Qty.
SKMA-95W	Mixed	1

View full product specs on page 432.



# Absorbent Spill Kits

BradyID.com/SPC

Absorbents and Spill Control



## Mobile Spill Truck - Large

- Wheel mounted polyethylene bins are chemical and water resistant. Spill trucks provide the highest level of readiness
- Absorbs up to 126 gallons per kit.
- Dimensions: 47"L X 34"W X 43"H

### • Contents of Universal, Oil Only and Chemical kits:

- 200 pads (15" x 19")
- 8 pillows (17" x 19")
- 3 pair nitrile gloves
- 24 SOCs (3" x 4')
- 15 disposal bags
- Emer. Response Guidebook
- 12 SOCs (3" x 12')
- 1 pair goggles

### • Contents of Marine Kit:

- 400 pads (15" x 19")
- 15 disposal bags
- Emer. Response Guidebook
- 4 booms (5" x 10')
- 1 pair goggles
- 3 pairs of nitrile gloves
- 1 sweep (19" x 100')

Catalog #	Type	Qty.
SKA-LT	Universal	1
SKO-LT	Oil Only	1
SKH-LT	Chemical	1
SKM-LT	Marine	1



## Mobile Spill Truck - X-Large

- Wheel mounted polyethylene bins are chemical and water resistant. Spill trucks provide the highest level of readiness
- Absorbs up to 174 gallons per kit
- Dimensions: 57.5"L X 40.5"W X 47"H

### • Contents of Universal, Oil Only and Chemical kits:

- 250 pads (15" x 19")
- 8 pillows (18" x 18")
- 1 pair goggles
- 36 SOCs (3" x 4')
- 30 disposal bags
- Emer. Response Guidebook
- 20 SOCs (3" x 12')
- 3 pairs of nitrile gloves

### • Contents of Marine Kit:

- 600 pads (15" x 19")
- 30 disposal bags
- Emer. Response Guidebook
- 8 booms (5" x 10')
- 3 pairs of nitrile gloves
- 2 sweeps (19" x 100')
- 1 pair goggles

Catalog #	Type	Qty.
SKA-XLT	Universal	1
SKO-XLT	Oil Only	1
SKH-XLT	Chemical	1
SKM-XLT	Marine	1



## Custom Spill Kit Program Only the products you need - in the quantities you want.

Brady also offers customers the opportunity to create their own Custom Spill Kits with an assortment of Brady's most popular pads, SOCs, booms, pillows, safety accessories and containers.

With no minimum requirements, these Custom Spill Kits give you the flexibility to pick only the products you need without the extra cost of items you don't want.

Create a safer work environment and save time, money and space with a Brady SPC Custom Spill Kit.

### Create Your Kit Now

Contact Brady Customer Service at 1-888-272-3946 for more information and to create your Custom Spill Kit.



**No minimum requirements means you can create your spill kit as large or small as you need!**

# Chemical Application Guide

BradyID.com/SPC

## Chemical Application Guide

Use the following guide to determine the compatibility of SPC absorbents with common chemicals.

Universal Polypropylene Products:
<ul style="list-style-type: none"> <li>Battlemat® Absorbents</li> <li>UXT Absorbents</li> <li>HT Absorbents</li> <li>MRO Plus® Absorbents</li> <li>GP Absorbents</li> <li>Basic Universal Absorbents</li> <li>SIR &amp; BSM Mats</li> <li>AIWIK® SOC's &amp; Pillows</li> <li>Cobra Coll® SOC</li> </ul>

Oil Only Polypropylene Products:
<ul style="list-style-type: none"> <li>Oil Only SOC's &amp; Pillows</li> <li>Trackmat Absorbents</li> <li>SXT® Oil Absorbents</li> <li>Oil Plus Absorbents</li> <li>SPC® Oil Absorbents</li> <li>ENV® Oil Absorbents</li> <li>Basic Oil Only Absorbents</li> <li>Static Resistant Absorbents</li> </ul>

Chemical Polypropylene Products:
<ul style="list-style-type: none"> <li>Chemical Absorbents</li> <li>Universal Plus Absorbents</li> <li>HAZWIK SOC's &amp; Pillows</li> </ul>

Organic Products:
<ul style="list-style-type: none"> <li>Re-Form™ Absorbents</li> <li>Re-Form™ Plus Absorbents</li> <li>Re-Form™ XPlus Absorbents</li> <li>Re-Form™ Oil Only Absorbents</li> <li>MULTIWIK® &amp; SLIKWIK® SOC's</li> <li>Dri-zorb Granular</li> <li>Re-Form™ Granular</li> <li>Rag Rug Absorbents</li> </ul>

Chemical	Universal	Oil Only	Chemical	Organic
Acetaldehyde	X		X	X
Acetic Acid	X		X	
Acetic Anhydride	X		X	
Acetone	X	X	X	X
Acetyl Chloride	X		X	
Acrolein	X	X	X	
Acrylonitrile	X		X	X
Allyl Alcohol	X		X	X
Aminobenzoic Acid	X		X	
Ammonia (Anhydrous)	X	X	X	X
Ammonium Hydroxide	X	X	X	X
Amyl Acetate	X	X	X	
Amyl Alcohol	X		X	X
Aniline	X		X	X
Antifreeze	X		X	X
Aqua Regia	X		X	
Aviation Fuel	X	X	X	X
Benzene	X	X	X	X
Benzoic Acid	X		X	
Benzonitrile	X		X	
Benzoyl Chloride	X		X	
Benzyl Alcohol	X		X	X
Boric Acid	X		X	
Brake Fluid	X	X	X	X
Bromine	X		X	
Butyl Acetate	X	X	X	
Butyl Alcohol	X	X	X	X
Butyric Acid	X	X	X	
Butylamine	X		X	X
Butyric Acid	X	X	X	
Calcium Hydroxide	X		X	
Carbolic Acid	X		X	
Carbon Disulfide	X		X	
Carbon Tetrachloride	X	X	X	X
Castor Oil	X	X	X	X
Chlorine Water	X		X	
Chloroacetic Acid	X		X	
Chlorobenzene	X		X	
Chloroform	X	X	X	X
Chromic Acid (50%)	X		X	
Chlorosulfonic Acid	X		X	
Citric Acid	X		X	
Clorox (Full Strength Bleach)	X		X	X
Corn Oil	X	X	X	X
Cottonseed Oil	X	X	X	X
Cresol	X	X	X	X

Chemical	Universal	Oil Only	Chemical	Organic
Cyclohexane	X	X	X	X
Detergents	X		X	X
Dichlorobenzene	X	X	X	
Diethylamine	X	X	X	
Diethyl Ether	X	X	X	X
Disooctyl Phthalate	X	X	X	X
Dinitrobenzene	X	X	X	
Dioxan	X		X	X
Ether	X	X	X	X
Ethyl Acetate	X	X	X	X
Ethyl Alcohol	X	X	X	X
Ethyl Benzene	X	X	X	
Ethyl Chloride	X	X	X	
Ethyl Ether	X	X	X	X
Ethyl Propionate	X	X	X	X
Ethylene Glycol	X		X	X
Formaldehyde	X		X	X
Formic Acid	X		X	
Fuel Oil	X	X	X	X
Gasoline	X	X	X	X
Gearbox Oil	X	X	X	X
Glacial Acetic Acid	X		X	
Glycerol	X		X	X
Heptane	X	X	X	X
Hexane	X	X	X	X
Hydrazine	X		X	
Hydrochloric Acid	X		X	
Hydrofluoric Acid	X		X	
Hydrogen Cyanide	X	X	X	
Hydrogen Peroxide	X		X	X
Isobutyl Alcohol	X	X	X	X
Isobutyric Acid	X	X	X	
Isopropyl Acetate	X	X	X	X
Isopropyl Alcohol	X	X	X	X
Kerosene	X	X	X	X
Keytones	X	X	X	X
Linseed Oil	X	X	X	X
Lubricating Oil	X	X	X	X
Magnesium Hydroxide	X		X	
Methyl Alcohol	X	X	X	X
Methyl Chloride	X	X	X	
Methyl Ether	X	X	X	X
Methyl Ethyl Ketone	X	X	X	X
Methyl Propionate	X	X	X	X
Mineral Oil	X	X	X	X
Motor Oil	X	X	X	X

Chemical	Universal	Oil Only	Chemical	Organic
Naphthalene	X	X	X	X
Nitric Acid	X		X	
Nitrobenzene	X		X	
Nitrobenzoic Acid	X		X	
Nitrotoluene	X	X	X	X
Octane	X	X	X	X
Oleic Acid	X	X	X	
Olive Oil	X	X	X	X
Paraffin	X	X	X	X
Perchloroethylene	X	X	X	X
Petroleum Ether	X	X	X	X
Phenol	X		X	X
Phosphoric Acid	X		X	
Plating Solutions	X		X	
Potassium Hydroxide	X		X	
Propanol	X		X	X
Propionic Acid	X	X	X	
Propyl Alcohol	X	X	X	X
Propylene Glycol	X	X	X	X
Quinoline	X		X	
Resorcinol	X		X	
Salt Solutions (metallic)	X		X	X
Silicone Oil	X	X	X	X
Silver Nitrate	X		X	X
Soap Solution (concentrated)	X	X	X	X
Sodium Bicarbonate	X		X	X
Sodium Chloride	X		X	X
Sodium Hydroxide	X		X	
Sodium Hypochlorite	X		X	X
Sodium Nitrate	X		X	X
Stannic Chloride	X		X	
Starch	X		X	X
Styrene	X	X	X	X
Sucrose	X		X	X
Sulfuric Acid	X		X	
Synthetic Motor Oil	X	X	X	X
Tannic Acid	X		X	
Toluene	X	X	X	X
Transformer Oil	X	X	X	X
Trichloroethylene	X	X	X	X
Triethylene Glycol	X	X	X	X
Turpentine	X	X	X	X
Urine	X		X	X
Vinyl Acetate	X	X	X	X
Vinegar	X		X	X
Xylene	X	X	X	X

Disclaimer: The above information is provided as a guide only. No claims or warranties are expressed or implied as to the absolute accuracy of the data supplied. In all cases it is assumed chemicals in question are at ambient temperatures and pressure and are used in basic state, not in combination or mixtures. Small test samplings by user is always recommended to ensure safe application.

View full product specs on page 432.



# Absorbent Specification Guide

BradyID.com/SPC

## Absorbent Specification Guide

Part Numbers	Type	Size	Perforated	Absorbency Factor (gl/g)	Absorbency Capacity (gal)	Shipping Wt. (lbs)	Pallet Qty.*	Quantity
96229	Spill Magnet	12" dia.	n/a	n/a	n/a	1	100	1/each
AD1500	Heavy Wt. Roll	15"x100'	No	8	11	15	30	1/case
AD30100	Heavy Wt. Roll	30"x100'	No	8	21	29	12	1/case
AW99	Universal Pillows	9"x9"	n/a	12.5	14	10	40	32/case
AW124	Universal SOCs	3"x12'	n/a	9	12	12	40	4/case
AW412	Universal SOCs	3"x4'	n/a	9	12	12	40	12/case
AW430	Universal SOCs	3"x4'	n/a	9	30	26	20	30/case
AW806	Universal SOCs	3"x8"	n/a	9	12	12	40	6/case
AW1818	Universal Pillows	18"x18"	n/a	12.5	28	19	20	16/case
AW1818-2	Universal Pillows	18"x18"	n/a	12.5	14	9.5	40	8/case
BM15	Heavy Wt. Roll	15"x150'	Yes, 7.5" and 12" across	12.5	25	17	30	1/case
BM30	Heavy Wt. Roll	30"x150'	Yes, 15" and every 15"	12.5	52	34.5	12	1/case
BM30X	Heavy Wt. Roll	30"x150'	No	12.5	52	34.5	12	1/case
BM100	Heavy Wt. Pad	15"x19"	Yes, 7.5"	12.5	27.5	16.5	40	100/bale
BPO100	Heavy Wt. Pad	15"x17"	Yes, 7.5"	18	20.5	8.5	30	100/bale
BRO152	Heavy Wt. Roll	15"x150'	Yes, every 30"	14.5	38	19.5	18	2/bale
BPO200	Light Wt. Pad	15"x17"	Yes, 7.5"	18	34	13.7	18	200/bale
BPO500	Light Wt. Pad	15"x17"	Yes, 7.5"	18	17	7	30	100/bale
BPU100	Heavy Wt. Pad	15"x17"	Yes, 7.5"	18	20.5	8.5	30	100/bale
BRU152	Heavy Wt. Roll	15"x150'	Yes, every 30"	14.5	38	19.5	18	2/bale
BPU200	Light Wt. Pad	15"x17"	Yes, 7.5"	18	34	13.7	18	200/bale
BPU500	Light Wt. Pad	15"x17"	Yes, 7.5"	18	17	7	30	100/bale
BRO150	Heavy Wt. Roll	30"x150'	Yes, every 30"	14.5	38	19.5	18	1/bale
BRU150	Heavy Wt. Roll	30"x150'	Yes, every 30"	14.5	38	19.5	18	1/bale
BSC20	Universal SOCs	3"x42"	n/a	15	84	24	20	20/case
BSC40	Universal SOCs	3"x42"	n/a	15	81	47.5	16	40/case
BSCSK-CB	BASIC Vehicle Spill Kit	n/a	n/a	n/a	7.75	7	50	1/each
BSM100	Medium Wt. Rug	36"x100'	No	8	25	24	40	1/bale
BSM300	Medium Wt. Rug	36"x300'	No	8	74	67	12	1/bale
BSM3650	Medium Wt. Rug	36"x50'	No	8	12	12	40	1/case
CB305	Boom	3' Float, 4.5' Skirt, 25' Sections	n/a	n/a	n/a	22.5	11	1/case
CB612	Boom	6' Float, 12' Skirt, 100' Sections	n/a	n/a	n/a	200	3	1/case
CC400	Universal SOCs	3"x4'	n/a	8.5	8.5	29	32	12/case
CC440V	Universal SOCs	3"x4'	n/a	8.5	56	30	16	40/case
CH15P	Heavy Wt. Roll	15"x150'	Yes, every 18"	12.5	20	14	30	1/bale
CH30DP	Heavy Wt. Roll	30"x150'	Yes, every 15" and up center	12.5	40	25	12	1/case
CH100	Heavy Wt. Pad	15"x19"	Yes, 7.5"	18	28	16	30	100/case
CH1212	Medium Wt. Pad	12"x12"	No	18	30	14.5	30	200/case
CH1212-50	Medium Wt. Pad	12"x12"	No	12.5	7.5	4	120	50/case
CH200	Light Wt. Pad	15"x19"	Yes, 7.5"	18	44	16	30	200/case
CH303	Medium Wt. Roll	30"x300'	yes, 15' every 15'	12.5	80	40	12	1/bale
CHBB15	Heavy Wt. Roll	15"x100'	No	11.7	13.4	11	30	1/bale
CHBB30	Heavy Wt. Roll	30"x100'	No	11.7	26.7	22	12	1/bale
CHBB100	Heavy Wt. Pad	15"x19"	No	11.7	21.2	15.75	30	100/case
CS-CB18	Oil Only Granular	18 lbs	n/a	8	18	1000	50	1 pallet
CS-LFB10	Oil Only Granular	10 lbs	n/a	8	10	640	64	1 pallet
DGUARD9	Drain Guard	36" X 48" X 18"	n/a	n/a	0.9	1	36	1/case
DGUARD14	Drain Guard	36" X 48" X 18"	n/a	n/a	1.4	2	36	1/case
DGUARD910	Drain Guard	36" X 48" X 18"	n/a	n/a	9	10	20	10/case
DGUARD1410	Drain Guard	36" X 48" X 18"	n/a	n/a	14	20	20	10/case
DPA24	Drip Pan	10"x10"	n/a	n/a	n/a	6	20	24/case
DTA25	Medium Wt. Universal Drum Cover	22" dia.	n/a	12.5	6	6	48	25/case
DTO25	Medium Wt. Oil Only Drum Cover	22" dia.	n/a	12.5	6	6	48	25/case

\* In an effort to reduce shipping costs for our customers, pallet quantities may vary.

DISCLAIMER: The above properties are "nominal" values used for PROCESS CONTROL when the product is produced and/or inspected. Performance "nominals" may vary depending upon the specific application, and/or the environment being applied, stored, or shipped. The "Absorbency" Spec and "SPCTM004" test method is based on the protocol of ASTM F726, using SAE20 non-detergent as the Oil Type, medium viscosity.



# Absorbent Specification Guide

BradyID.com/SPC

Part Numbers	Type	Size	Perforated	Absorbency Factor (g/g)	Absorbency Capacity (gal)	Shipping Wt. (lbs)	Pallet Qty.*	Quantity
DZ100	Universal Granular	40 lbs	n/a	1.5	8.5	1600	40	1 pallet
ENV50	Medium Wt. Pad	30"x30"	No	20	50	19	7	50/bale
ENV100	Heavy Wt. Pad	15"x19"	No	20	33	12.5	24	100/bale
ENV150	Medium Wt. Roll	30"x150'	No	15	44	22	18	1/bale
ENV200	Light Wt. Pad	15"x19"	No	23	51	16	18	200/bale
ENV300	Medium Wt. Pad	15"x19"	No	20	28	10	24	100/bale
ENV500	Light Wt. Pad	15"x19"	No	23	24.5	8	30	100/bale
ENV510	ENV Boom	5"x10'	n/a	12.6	32	19	20	4/bale
ENV810	ENV Boom	8"x10'	n/a	13	65	38	10	4/bale
GP30	Heavy Wt. Roll	30"x150'	No	13	48	28	18	1/bale
GP100	Heavy Wt. Pad	15"x19"	Yes, 7.5"	18	30	11.5	24	100/case
GP100-B	Heavy Wt. Pad (bagged)	15"x19"	Yes, 7.5"	18	30	12	24	100/bale
GP200-B	Light Wt. Pad (bagged)	15"x19"	Yes, 7.5"	20	44	16	18	200/bale
GP300	Medium Wt. Pad	15"x19"	Yes, 7.5"	20	28	10	30	100/bale
GP500	Light Wt. Pad	15"x19"	Yes, 7.5"	20	22	8.2	30	100/bale
GS-10	Oil Only Granular	30 lbs	n/a	2 to 6	23	1800	60	1 pallet
HAZ99	Chemical Pillows	9"x9"	n/a	12.5	10	14	40	32/case
HAZ124	Chemical SOCs	3"x12'	n/a	9	12	12	40	4/case
HAZ412	Chemical SOCs	3"x4'	n/a	9	12	12	40	12/case
HAZ1818	Chemical Pillows	18"x18"	n/a	12.5	14	9.5	20	16/case
HAZ1818-2	Chemical Pillows	18"x18"	n/a	12.5	14	9.5	40	8/case
HT15	Heavy Wt. Roll	15"x150'	Yes, every 15"	12.5	23	16	30	1/case
HT30	Heavy Wt. Roll	30"x150'	Yes, 15" and every 15"	12.5	47	32	12	1/case
HT153	Medium Wt. Roll	15"x300'	Yes, every 15"	12.5	32	20	24	1/bale
HT200	Light Wt. Pad	15"x19"	Yes, 7.5"	12.5	38	16.5	24	200/case
HT215	Light Wt. Roll	15"x300'	Yes, every 15"	12.5	21.5	15	18	1/bale
HT230	Light Wt. Roll	30"x300'	Yes, 15" and every 15"	12.5	42.5	29.5	18	1/bale
HT303	Medium Wt. Roll	30"x300'	Yes, 15" and every 15"	12	63	40	12	1/bale
HT303X	Medium Wt. Roll	30"x300'	No	12.5	65	40	12	1/bale
HT350	Medium Wt. Roll	30"x150'	Yes, 15" and every 18"	12.5	35	20	12	1/bale
HT500	Light Wt. Pad	15"x19"	Yes, 7.5"	12.5	13.5	8.5	30	100/case
HT550	Heavy Wt. Roll	15"x50'	Yes (3), 5" and every 18"	12.5	8	5	60	1/case
HT555	Heavy Wt. Roll	15"x150'	Yes (3), 5" and every 18"	12.5	23	16	30	1/case
HTBB15	Heavy Wt. Roll	15"x100'	No	10.1	11.5	10	30	1/bale
HTBB30	Heavy Wt. Roll	30"x100'	No	10.1	23.1	20	12	1/bale
HTBB100	Heavy Wt. Pad	15"x19"	No	10.1	18.3	14.75	30	100/case
MRO12P	Heavy Wt. Roll	12"x150'	Yes, every 12"	12.5	20	11.5	36	1/bale
MRO15	Heavy Wt. Roll	15"x150'	No	12.5	24	17.5	30	1/case
MRO15DP	Heavy Wt. Roll	15"x150'	Yes, 7.5" and 12" across	12.5	24	17.5	30	1/case
MRO15DPS	Heavy Wt. Roll	15"x73'	Yes, 7.5" and 12" across	12.5	12	8	80	1/bale
MRO15P	Heavy Wt. Roll	15"x150'	Yes, every 18"	12.5	24	17.5	30	1/case
MRO24DP	Heavy Wt. Roll	24"x150'	Yes, every 12" and up center	12.5	39	22.5	27	1/bale
MRO30	Heavy Wt. Roll	30"x150'	No	12.5	49	33	12	1/case
MRO30DP	Heavy Wt. Roll	30"x150'	Yes, every 15" and up center	12.5	49	32	12	1/case
MRO30P	Heavy Wt. Roll	30"x150'	Yes, every 30"	12.5	49	32	12	1/case
MRO50	Heavy Wt. Pad	30"x30"	Yes, 15"	12.5	41	26.5	13	50/bale
MRO100	Heavy Wt. Pad	15"x19"	Yes, 7.5"	12.5	26	17.5	30	100/case
MRO100-2	Heavy Wt. Pad	15"x19"	Yes, 7.5"	12.5	13.5	8	36	50/bale
MRO150DND	Heavy Wt. Pad	15"x19"	Yes, 7.5"	12.5	39	27	18	150/case
MRO300	Medium Wt. Pad	15"x19"	Yes, 7.5"	12.5	20.5	14	30	100/case
MRO315P	Medium Wt. Roll	15"x150'	Yes, every 18"	12.5	20	14	30	1/case
MRO350	Medium Wt. Roll	30"x150'	No	12.5	38	26.5	12	1/case
MRO350DP	Medium Wt. Roll	30"x150'	Yes, 15" and every 15"	12.5	38	26.5	12	1/case
MS50	Universal SOCs	3"x4'	n/a	7	40	43	15	40/case
MS124	Universal SOCs	3"x12'	n/a	8.5	12	12	42	4/case
MS412	Universal SOCs	3"x4'	n/a	8.5	12	12	42	12/case

\* In an effort to reduce shipping costs for our customers, pallet quantities may vary.

DISCLAIMER: The above properties are "nominal" values used for PROCESS CONTROL when the product is produced and/or inspected. Performance "nominals" may vary depending upon the specific application, and/or the environment being applied, stored, or shipped. The "Absorbency" Spec and "SPCTM004" test method is based on the protocol of ASTM F726, using SAE20 non-detergent as the Oil Type, medium viscosity.



# Absorbent Specification Guide

BradyID.com/SPC

Part Numbers	Type	Size	Perforated	Absorbency Factor (gl/gg)	Absorbency Capacity (gal)	Shipping Wt. (lbs)	Pallet Qty. *	Quantity
MS806	Universal SOCs	3"x8'	n/a	8.5	12	12	42	6/case
MXO1000	Light Wt. Pad	15"x19"	Yes, 7.5"	23	26	11	30	100/case
MXP-C20	Chemical Spill Kit	15.5"L x 19.5"W x 20.5"H	n/a	n/a	30	14	18	5/case
MXP-O20	Oil Only Spill Kit	15.5"L x 19.5"W x 20.5"H	n/a	n/a	35	15	18	5/case
MXP-U20	Universal Spill Kit	15.5"L x 19.5"W x 20.5"H	n/a	n/a	30	14.4	18	5/case
MXU1000	Light Wt. Pad	15"x19"	Yes, 7.5"	24	27	11	30	100/case
MW-13	Stainless Steel Oil Skimming System	13" x 14" x 22"	n/a	n/a	n/a	50	n/a	1/each
ODN08	Oil Only Net	30 nets on 50' rope	n/a	15	15	16	24	1/bale
OIL99	Oil Only Pillows	9"x9"	n/a	12.5	14	10	40	32/case
OIL124	Oil Only SOCs	3"x12'	n/a	9	12	11	40	4/case
OIL412	Oil Only SOCs	3"x4'	n/a	9	12	11	40	12/case
OIL430	Oil Only SOCs	3"x4'	n/a	9	28	30	20	30/case
OIL806	Oil Only SOCs	3"x8'	n/a	9	12	11	40	6/case
OIL1818	Oil Only Pillows	18"x18"	n/a	12.5	28	19	20	16/case
OIL1818-2	Oil Only Pillows	18"x18"	n/a	12.5	14	9.5	40	8/case
ONO30	Oil Only Net	30 nets (no rope)	n/a	15	15	17	24	1/bale
OP15	Heavy Wt. Roll	15"x150'	No	12.5	24	17.5	30	1/case
OP15DP	Heavy Wt. Roll	15"x150'	Yes, 7.5" and 12" across	12.5	24	17.5	30	1/case
OP15DPS	Heavy Wt. Roll	15"x73'	Yes, 7.5" and 12" across	12.5	12	7.5	80	1/bale
OP15P	Heavy Wt. Roll	15"x150'	Yes, every 18"	12.5	24	17.5	30	1/case
OP30	Heavy Wt. Roll	30"x150'	No	12.5	49	33	15	1/case
OP30DP	Heavy Wt. Roll	30"x150'	Yes, 15" and every 15"	12.5	49	33	12	1/case
OP30P	Heavy Wt. Roll	30"x150'	Yes, every 30"	12.5	49	33	12	1/case
OP50	Heavy Wt. Pad	30"x30"	Yes, 15"	12.5	41	24	13	50/bale
OP100	Heavy Wt. Pad	15"x19"	Yes, 7.5"	12.5	26	17.5	30	100/case
OP150DND	Heavy Wt. Pad	15"x19"	Yes, 7.5"	12.5	39	27	18	150/case
OP300	Medium Wt. Pad	15"x19"	Yes, 7.5"	12.5	20.5	14	30	100/case
OP315P	Medium Wt. Roll	15"x150'	Yes, every 18"	12.5	19	14	30	1/case
OP350DP	Medium Wt. Roll	30"x150'	Yes, 15" and every 15"	12.5	38	26.5	12	1/case
OP550	Heavy Wt. Roll	15"x50'	Yes, every 18"	12.5	9	5	60	1/case
PLUG2	Drain Plug	2" Plug	n/a	n/a	n/a	2	250	1/case
PLUG3	Drain Plug	3" Plug	n/a	n/a	n/a	3	250	1/case
PLUG4	Drain Plug	4" Plug	n/a	n/a	n/a	4	250	1/case
PLUG6	Drain Plug	6" Plug	n/a	n/a	n/a	6	250	1/case
PVC18	Slikstopper	18"x18"	n/a	n/a	n/a	9	100	1/case
PVC24	Slikstopper	24"x24"	n/a	n/a	n/a	14	30	1/case
PVC36	Slikstopper	36"x36"	n/a	n/a	n/a	34	25	1/case
PVC42	Slikstopper	42"x42"	n/a	n/a	n/a	46	20	1/case
RAG1818	Heavy Wt. Rug	18"x18"	No	9	38	32	18	50/case
RAG24150	Heavy Wt. Rug	24"x150'	No	9	37	52	10	1/bale
RAG36150	Heavy Wt. Rug	36"x150'	No	9	55	47	12	1/bale
RF100	Heavy Wt. Pad	15"x19"	No	17.5	40	19	24	100/case
RF300	Medium Wt. Pad	15"x19"	No	17.5	32	14.8	30	100/case
RF500	Light Wt. Pad	15"x19"	No	17.5	24	12	36	100/case
RFDP300	Medium Wt. Pad	16"x18"	Yes, 7.5"	16.5	32	16.6	30	100/case
RFDP328-DP	Medium Wt. Roll	28.5"x150'	Yes, 14.25" and every 19"	16.5	55	33.3	12	1/case
RFGRANULAR	Re-Form Granular	30 lbs	n/a	1	16.7	1950	65	1 pallet
RF0412	Oil Only SOCs	3"x4'	n/a	13.5	15	10.5	40	12/case
RFODP100	Heavy Wt. Pad	15"x19"	Yes, 7.5"	30	39	12	24	100/case
RFOP14P	Heavy Wt. Roll	14.25"x150'	Yes, every 19"	30	37	10.5	24	1/case
RFOP28-DP	Heavy Wt. Roll	28.5"x150'	Yes, 14.25" and every 19"	30	74	21	12	1/case
RFP28-DP	Heavy Wt. Roll	28.5"x150'	Yes, 14.25" and every 19"	17	62	33	12	1/case
RFP100	Heavy Wt. Pad	15"x19"	Yes, 7.5"	17	40	19.5	24	100/case
RFP314P	Medium Wt. Roll	14.25"x150'	Yes, every 19"	17	29	15.5	24	1/case
RFP328-DP	Medium Wt. Roll	28.5"x150'	Yes, 14.25" and every 19"	17	53	30.5	12	1/case
RFP500	Light Wt. Pad	15"x19"	Yes, 7.5"	17	24	12.7	36	100/case

\* In an effort to reduce shipping costs for our customers, pallet quantities may vary.

DISCLAIMER: The above properties are "nominal" values used for PROCESS CONTROL when the product is produced and/or inspected. Performance "nominals" may vary depending upon the specific application, and/or the environment being applied, stored, or shipped. The "Absorbency" Spec and "SPCTM004" test method is based on the protocol of ASTM F726, using SAE20 non-detergent as the Oil Type, medium viscosity.

# Absorbent Specification Guide

BradyID.com/SPC

Part Numbers	Type	Size	Perforated	Absorbency Factor (gl/g)	Absorbency Capacity (gal)	Shipping Wt. (lbs)	Pallet Qty. *	Quantity
RFPP30P	Heavy Wt. Roll	30'x150'	Yes, 30"	12.5	49	32	12	1/case
RFPP100	Heavy Wt. Pad	15'x19'	Yes, 7.5"	12.5	26	17.5	30	100/case
SB-1010	Standard Spill Berm	10'x10'x1'	n/a	n/a	748	47	1	1/each
SB-1212	Standard Spill Berm	12'x12'x1'	n/a	n/a	1,077	60	1	1/each
SB-1226	Standard Spill Berm	12'x26'x1'	n/a	n/a	n/a	112	1	1/each
SB-1236	Standard Spill Berm	12'x36'x1'	n/a	n/a	n/a	149	1	1/each
SB-SL44	Lightweight Spill Berm	4'x4'x8"	n/a	n/a	79	6	20	1/each
SB-SL46	Lightweight Spill Berm	4'x6'x8"	n/a	n/a	119	8	10	1/each
SC-4	Set of 4 casters	n/a	n/a	n/a	n/a	n/a	n/a	1 pack
SC-3000	Absorbent Center	50"L X 26"W X 7.75"H	n/a	n/a	n/a	50	15	1/each
SC-ACC	Accessory Pack	n/a	n/a	n/a	n/a	n/a	n/a	1 pack
SC-Cabinet	Spill Control Cabinet	19-7/8 x 14-1/4x 32-3/4	n/a	n/a	n/a	45	9	1/each
SC-Cart	Spill Control Cart	36 x 18 x 38-3/8	n/a	n/a	n/a	180	1	1/each
SC-D15	15" Dowel Rod	15'	n/a	n/a	n/a	n/a	n/a	1 rod
SC-D40	40" Dowel Rod	40'	n/a	n/a	n/a	n/a	n/a	1 rod
SC-DK	Sump Drain Kit	n/a	n/a	n/a	n/a	2	100	1/case
SC-MB	Wall Mount	n/a	n/a	n/a	n/a	n/a	n/a	1 each
SC-DP2	2-Drum Spill Pallet	26"W X 52"L X 17"H	n/a	68.7	2,500	46.5	10	1/each
SC-DP4	4-Drum Spill Pallet	52"W X 52"L X 17"H	n/a	128.9	5,000	89	10	1/each
SC-DPR	Spill Pallet Ramp	32.5"W X 70"L	n/a	n/a	650	47.5	3	1/each
SC-SD2	2 Drum Spill Deck	26"W X 52"L X 6"H	n/a	21.2	2,500	31	15	1/each
SIR36	Heavy Wt. Rug	36"x300'	No	8.5	59	50	12	1/bale
SIR72	Heavy Wt. Rug	72"x150'	No	8.5	59	50	12	1/bale
SIR36150	Heavy Wt. Rug	36"x150'	No	12.5	45	25	24	1/bale
SKA-20	Universal Spill Kit	21"Dia. X 18"H	n/a	n/a	15	27	18	1/each
SKA-20-RESCUE	Universal Spill Kit	21"Dia. X 18"H	n/a	n/a	15	20	18	1/each
SKA-20-TAA	Universal Spill Kit	21"Dia. X 18"H	n/a	n/a	15	26	18	1/each
SKA-30	Universal Spill Kit	21.125"Dia. X 28.5"H	n/a	n/a	36	41	18	1/each
SKA-30-TAA	Universal Spill Kit	21.125"Dia. X 28.5"H	n/a	n/a	36	41	18	1/each
SKA-55	Universal Spill Kit	24"Dia. X 37"H	n/a	n/a	38	57	8	1/each
SKA-55-TAA	Universal Spill Kit	24"Dia. X 37"H	n/a	n/a	38	56	8	1/each
SKA-55W	Universal	24"Dia. X 37"H	n/a	n/a	38	57	8	1/each
SKA-65	Universal Spill Kit	31"Dia. X 33.5"H	n/a	n/a	63	100	3	1/each
SKA-65-TAA	Universal Spill Kit	31"Dia. X 33.5"H	n/a	n/a	63	100	3	1/each
SKA-65W	Universal Spill Kit	31"Dia. X 33.5"H	n/a	n/a	63	100	3	1/each
SKA-95	Universal Spill Kit	31.5"Dia. X 35"H	n/a	n/a	75	107	3	1/each
SKA-95W	Universal	31.5"Dia. X 35"H	n/a	n/a	75	107	3	1/each
SKA-ATK	Universal Spill Kit	20"L X 16"W X 4"H	n/a	n/a	7	36.5	24	4/case
SKA-ATK-TAA	Universal Spill Kit	20"L X 16"W X 4"H	n/a	n/a	7	36.5	24	4/case
SKA-BKT	Universal Spill Kit	14"Dia. X 18"H	n/a	n/a	9	9	60	1/each
SKA-BKTACID	Acid Neutralizing Spill Kit	13.5" Dia. x 18"H	n/a	n/a	4.5	16.5	60	1/each
SKA-BKTBASE	Base Neutralizer Spill Kit	13.5" Dia. x 18"H	n/a	n/a	4.5	16.5	60	1/each
SKA-BKT-TAA	Universal Spill Kit	14"Dia. X 18"H	n/a	n/a	6	9	60	1/each
SKA-CFB	Universal Spill Kit	25.5"L x 17"W x 21.5"H	n/a	n/a	15	25	20	1 each
SKA-K2	Universal Spill Kit	18"L X 17"W X 39"H	n/a	n/a	22	42	10	1/each
SKA-LT	Universal Spill Kit	47"L X 34"W X 43"H	n/a	n/a	126	164	1	1/each
SKA-PP	Universal Spill Kit	20"L X 16"W X 4"H	n/a	n/a	5	24	20	1/each
SKA-PP-TAA	Universal Spill Kit	20"L X 16"W X 4"H	n/a	n/a	5	24	20	1/each
SKA-SAK	Universal Spill Kit	32"L X 20"W X 12"H	n/a	n/a	10.75	10	20	1/each
SKA-SRP	Universal Spill Kit	9.75"D X 10.5"H	n/a	n/a	4.5	2.5	90	1/each
SKA-XLT	Universal Spill Kit	57.5"L X 40.5"W X 47"H	n/a	n/a	174	221	1	1/each
SK-CAMO	Camouflaged Vehicle Spill Kit	n/a	n/a	n/a	11.5	9	50	1/each
SK-CAMO-RS	Camouflaged Vehicle Spill Kit with RuptureSEAL	n/a	n/a	n/a	11.5	9	50	1/each
SKH-20	Chemical Spill Kit	21"Dia. X 18"H	n/a	n/a	15	26	18	1/each
SKH-20-RESCUE	Chemical Spill Kit	21"Dia. X 18"H	n/a	n/a	15	20	18	1/each

\* In an effort to reduce shipping costs for our customers, pallet quantities may vary.

DISCLAIMER: The above properties are "nominal" values used for PROCESS CONTROL when the product is produced and/or inspected. Performance "nominals" may vary depending upon the specific application, and/or the environment being applied, stored, or shipped. The "Absorbency" Spec and "SPCTM004" test method is based on the protocol of ASTM F726, using SAE20 non-detergent as the Oil Type, medium viscosity.



# Absorbent Specification Guide

BradyID.com/SPC

Absorbents and Spill Control

Part Numbers	Type	Size	Perforated	Absorbency Factor (gl/g)	Absorbency Capacity (gal)	Shipping Wt. (lbs)	Pallet Qty.*	Quantity
SKH-30	Chemical Spill Kit	21.125"Dia. X 28.5"H	n/a	n/a	36	41	18	1/each
SKH-55	Chemical Spill Kit	24"Dia. X 37"H	n/a	n/a	38	52	8	1/each
SKH-55W	Chemical Spill Kit	24"Dia. X 37"H	n/a	n/a	38	52	8	1/each
SKH-65	Chemical Spill Kit	31"Dia. X 33.5"H	n/a	n/a	63	100	3	1/each
SKH-65W	Chemical Spill Kit	31"Dia. X 33.5"H	n/a	n/a	63	100	3	1/each
SKH-95	Chemical Spill Kit	31.5"Dia. X 35"H	n/a	n/a	75	104	3	1/each
SKH-95W	Chemical Spill Kit	31.5"Dia. X 35"H	n/a	n/a	75	104	3	1/each
SKH-ATK	Chemical Spill Kit	20"L X 16"W X 4"H	n/a	n/a	7	25	24	4/case
SKH-BKT	Chemical Spill Kit	14"Dia. X 18"H	n/a	n/a	9	8	60	1/each
SKH-CFB	Chemical Spill Kit	25.5"L x 17"W x 21.5"H	n/a	n/a	15	25	20	1 each
SKH-K2	Chemical Spill Kit	18"L X 17"W X 39"H	n/a	n/a	22	42	10	1/each
SKH-LT	Chemical Spill Kit	47"L X 34"W X 43"H	n/a	n/a	115	158	1	1/each
SKH-PP	Chemical Spill Kit	20"L X 16"W X 4"H	n/a	n/a	5	24	20	1/each
SKH-SAK	Chemical Spill Kit	32"L X 20"W X 12"H	n/a	n/a	10.75	10	20	1/each
SKH-SRP	Chemical Spill Kit	9.75"D X 10.5"H	n/a	n/a	4.5	2.5	90	1/each
SKH-XLT	Chemical Spill Kit	57.5"L X 40.5"W X 47"H	n/a	n/a	160	221	1	1/each
SKMA-20	Mixed Application Spill Kit	21"Dia. X 18"H	n/a	n/a	15	20	18	1/each
SKMA-30	Mixed Application Spill Kit	21.125"Dia. X 28.5"H	n/a	n/a	36	41	18	1/each
SKMA-55	Mixed Application Spill Kit	24"Dia. X 37"H	n/a	n/a	38	52	8	1/each
SKMA-55W	Mixed Application Spill Kit	24"Dia. X 37"H	n/a	n/a	38	52	8	1/each
SKMA-65	Mixed Application Spill Kit	31"Dia. X 33.5"H	n/a	n/a	63	100	3	1/each
SKMA-65W	Mixed Application Spill Kit	31"Dia. X 33.5"H	n/a	n/a	63	100	3	1/each
SKMA-95	Mixed Application Spill Kit	31.5"Dia. X 35"H	n/a	n/a	75	107	3	1/each
SKMA-95W	Mixed Application Spill Kit	31.5"Dia. X 35"H	n/a	n/a	75	107	3	1/each
SKM-LT	Marine Spill Kit	47"L X 34"W X 43"H	n/a	n/a	153	164	1	1/each
SKM-XLT	Marine Spill Kit	57.5"L X 40.5"W X 47"H	n/a	n/a	258	258	1	1/each
SKO-20	Oil Only Spill Kit	21"Dia. X 18"H	n/a	n/a	15	20	18	1/each
SKO-20-RESCUE	Oil Only Spill Kit	21"Dia. X 18"H	n/a	n/a	15	20	18	1/each
SKO-30	Oil Only Spill Kit	21.125"Dia. X 28.5"H	n/a	n/a	36	41	18	1/each
SKO-55	Oil Only Spill Kit	24"Dia. X 37"H	n/a	n/a	38	56	8	1/each
SKO-55W	Oil Only Spill Kit	24"Dia. X 37"H	n/a	n/a	38	56	8	1/each
SKO-65	Oil Only Spill Kit	31"Dia. X 33.5"H	n/a	n/a	63	100	3	1/each
SKO-65W	Oil Only Spill Kit	31"Dia. X 33.5"H	n/a	n/a	63	100	3	1/each
SKO-95	Oil Only Spill Kit	31.5"Dia. X 35"H	n/a	n/a	75	107	3	1/each
SKO-95W	Oil Only Spill Kit	31.5"Dia. X 35"H	n/a	n/a	75	107	3	1/each
SKO-ATK	Oil Only Spill Kit	20"L X 16"W X 4"H	n/a	n/a	7	23	24	4/case
SKO-BKT	Oil Only Spill Kit	14"Dia. X 18"H	n/a	n/a	9	9	60	1/each
SKO-CFB	Oil Only Spill Kit	25.5"L x 17"W x 21.5"H	n/a	n/a	15	25	20	1 each
SKO-K2	Oil Only Spill Kit	18"L X 17"W X 39"H	n/a	n/a	22	42	10	1/each
SKO-LT	Oil Only Spill Kit	47"L X 34"W X 43"H	n/a	n/a	126	185	1	1/each
SKO-PP	Oil Only Spill Kit	20"L X 16"W X 4"H	n/a	n/a	5	24	20	1/each
SKO-SAK	Oil Only Spill Kit	32"L X 20"W X 12"H	n/a	n/a	10.75	10	20	1/each
SKO-SRP	Oil Only Spill Kit	9.75"D X 10.5"H	n/a	n/a	4.5	2.5	90	1/each
SKO-XLT	Oil Only Spill Kit	57.5"L X 40.5"W X 47"H	n/a	n/a	174	221	1	1/each
SKR-20	Re-Form Spill Kit	21"Dia. X 18"H	n/a	n/a	15	27	18	1/each
SKR-55	Re-Form Spill Kit	24"Dia. X 37"H	n/a	n/a	38	57	8	1/each
SKR-95	Re-Form Spill Kit	31.5"Dia. X 35"H	n/a	n/a	75	107	3	1/each
SKR-ATK	Re-Form Spill Kit	20"L X 16"W X 4"H	n/a	n/a	7	36.5	24	4/case
SKR-PP	Re-Form Spill Kit	20"L X 16"W X 4"H	n/a	n/a	5	24	20	1/each
SPC10	Pillow	14"x25"	n/a	12.5	52	30	10	10/bale
SPC50	Heavy Wt. Pad	33"x39"	No	18	73	33.5	7	50/bale
SPC100	Heavy Wt. Pad	15"x19"	Yes, 7.5"	18	35	14	30	100/bale
SPC100B	Heavy Wt. Pad (Blue MBPP Pad)	15"x19"	Yes, 7.5"	18	35	14	30	100/bale
SPC105	Heavy Wt. Pad (1 side w/blue coverstock)	15"x19"	Yes, 7.5"	18	35	14	30	100/bale
SPC150	Heavy Wt. Roll	38"x144'	No	15	70	33	18	1/bale
SPC152	Heavy Wt. Roll	19"x144'	No	15	70	33	18	2/bale

\* In an effort to reduce shipping costs for our customers, pallet quantities may vary.

DISCLAIMER: The above properties are "nominal" values used for PROCESS CONTROL when the product is produced and/or inspected. Performance "nominals" may vary depending upon the specific application, and/or the environment being applied, stored, or shipped. The "Absorbency" Spec and "SPCTM004" test method is based on the protocol of ASTM F726, using SAE20 non-detergent as the Oil Type, medium viscosity.

# Absorbent Specification Guide

BradyID.com/SPC

Part Numbers	Type	Size	Perforated	Absorbency Factor (gl/g)	Absorbency Capacity (gal)	Shipping Wt. (lbs)	Pallet Qty.*	Quantity
SPC156	Medium Wt. Roll (1 side w/blue coverstock)	30"x150'	Yes, 15" and every 15"	15	37	26.5	18	1/bale
SPC200	Light Wt. Pad	15"x19"	Yes, 7.5"	18	51	16	18	200/bale
SPC300	Medium Wt. Pad	15"x19"	Yes, 7.5"	18	30	11	30	100/bale
SPC318	SPC Boom	3"x18"	n/a	9.5	14	10	40	25/case
SPC500	Light Wt. Pad	15"x19"	Yes, 7.5"	18	20	8.2	30	100/bale
SPC510	SPC Boom	5"x10'	n/a	12.6	32	19	16	4/bale
SPC518	SPC Boom	5"x18"	n/a	12.6	12	8	40	10/case
SPC810	SPC Boom	8"x10'	n/a	13.3	71	40	10	4/bale
SPC818	SPC Boom	8"x18"	n/a	12.5	28	17	16	10/bale
SPC1900	Sweep	19"X100'	n/a	15	26	13	36	1/bale
SPC5510	SPC Boom	5"x10'	n/a	12.1	61	38	12	2/bale
SPC19150	Heavy Wt. Roll	19"x144'	No	15	35	17	36	1/bale
SPC-ACID	2lb Acid Neutralizing Polymer Shaker	n/a	n/a	n/a	0.65	2	1200	1/each
SPC-BASE	2lb Base Neutralizing Polymer Shaker	n/a	n/a	n/a	0.65	2	1200	1/each
SPCUN1019	Medium Wt. Roll	15"x150'	Yes, 15" and every 15"	12.5	39	24	15	2/case
SPCUN1113	Medium Wt. Pad	12"x12"	No	16	12.5	16	30	200/case
SPCUN1113-50	Medium Wt. Pad	12"X12"	No	12.5	5.5	4	120	50/case
SPCUN1719	Medium Wt. Pad	15"x19"	Yes, 7.5"	12.5	20.5	14.5	30	100/case
SPCUN3800	Medium Wt. Roll	30"x150'	Yes, 15" and every 15"	12.5	39	27	12	1/case
SR100	Heavy Wt. Pad	15" x19"	No	13	26	14.5	30	100/bale
SR1825	Medium Wt. Pad	15"x19"	No	15	6	3.2	90	25/bale
SR3600	Heavy Wt. Roll	30"x150'	No	15	44	22	18	1/bale
SR3625	Heavy Wt. Pad	30"x30"	No	13	16	9	14	25/bale
SRP75P	Heavy Wt. Roll	7.5"x50'	Yes, 10"	12.5	3.3	1.85	96	1/bale
SRP100	Heavy Wt. Pad	7.5"x10"	No	12.5	5.5	4	96	100/case
SRP200	Heavy Wt. Pad	7.5"x10"	No	12.5	11.1	7.5	96	200/case
SRPH75P	Heavy Wt. Plus Roll	7.5"x50'	Yes, 10"	12.5	3.3	1.85	96	1/bale
SRPH100	Heavy Wt. Plus Pad	7.5"x10"	No	12.5	5.5	4	96	100/case
SRPH200	Heavy Wt. Plus Pad	7.5"x10"	No	12.5	11.1	7.5	96	200/case
SRPO75P	Heavy Wt. Roll	7.5"x50'	Yes, 10"	12.5	3.3	1.85	96	1/bale
SRPO100	Heavy Wt. Pad	7.5"x10"	No	12.5	5.5	4	96	100/case
SRPO200	Heavy Wt. Pad	7.5"x10"	No	12.5	11.1	7.5	96	200/case
SW46	Universal SOCs	3"x42"	n/a	3	20	50	16	40/case
SXT15P	Heavy Wt. Roll	15"x150'	Yes, every 18"	12	18	14	30	1/case
SXT30DP	Heavy Wt. Roll	30"x150'	Yes, 15" and every 15"	12	37	26.5	12	1/case
SXT100	Heavy Wt. Pad	15"x19"	Yes, 7.5"	12	19.5	14.5	30	100/case
SXT200	Light Wt. Pad	15"x19"	Yes, 7.5"	14	31.5	18	24	200/case
SXT300	Medium Wt. Pad	15"x19"	Yes, 7.5"	12	17	10	30	100/case
TM19	Heavy Wt. Roll	19"x80'	No	9	26	32	18	2/bale
TM29	Heavy Wt. Roll	29"x80'	No	9	20	24	32	1/bale
TM30	Heavy Wt. Pad	29"x29"	No	9	25	15	15	30/bale
TM58	Heavy Wt. Roll	58"x80'	No	9	55	34	9	1/bale
UXT15P	Heavy Wt. Roll	15"x150'	Yes, every 18"	11	17	14.5	30	1/case
UXT30DP	Medium Wt. Roll	30"x150'	Yes, 15" and every 15"	11	35	27.5	12	1/case
UXT100	Heavy Wt. Pad	15"x19"	Yes, 7.5"	11	19	14.5	30	100/case
UXT200	Light Wt. Pad	15"x19"	Yes, 7.5"	14	31.5	18.5	24	200/case
UXT300	Medium Wt. Pad	15"x19"	Yes, 7.5"	11	17	12	30	100/case
VS12P	Heavy Wt. Roll	12"x60"	Yes, 12"	12.5	13.6	9.5	30	20/case
VS75P	Heavy Wt. Roll	7.5"x50"	Yes, 10"	12.5	5.56	4.27	40	20/case
VSH12P	Heavy Wt. Roll	12"x60"	Yes, 12"	12.5	13.6	9.5	30	20/case
VSH75P	Heavy Wt. Roll	7.5"x50"	Yes, 10"	12.5	5.56	4.27	40	20/case
VSO12P	Heavy Wt. Roll	12"x60"	Yes, 12"	12.5	13.6	9.5	30	20/case
VSO75P	Heavy Wt. Roll	7.5"x50"	Yes, 10"	12.5	5.56	4.27	40	20/case

\* In an effort to reduce shipping costs for our customers, pallet quantities may vary.

DISCLAIMER: The above properties are "nominal" values used for PROCESS CONTROL when the product is produced and/or inspected. Performance "nominals" may vary depending upon the specific application, and/or the environment being applied, stored, or shipped. The "Absorbency" Spec and "SPCTM004" test method is based on the protocol of ASTM F726, using SAE20 non-detergent as the Oil Type, medium viscosity.



# Lockout Tagout

[BradyID.com/lockouttagout](http://BradyID.com/lockouttagout)

## Why Lockout Tagout?

Lockout Tagout (LOTO) is an important safety procedure - critical to safeguarding workers and employees around the machinery and equipment they operate, service and maintain. It is also a major OSHA-inspection focus. In fact, it remains one of the most cited violations for general industry even after 20 years in force. But, rather than focusing on the negative aspects of non-compliance and citations, focus instead on the benefits a thoroughly-developed LOTO program provides:

- **LIVES SAVED** – preventing an estimated 250,000 incidents, 50,000 injuries and 120 fatalities annually!
- **CUT COSTS** – both in lost employee time and insurance costs
- **IMPROVED PRODUCTIVITY** – minimizing equipment downtime
- **BEST PRACTICE** - being widely adopted across industries and industrialized countries



## 5 Steps To An Effective Lockout Program

A successful Lockout Tagout (LOTO) program starts with a solid foundation and a written plan. After that, proactive training and employee awareness programs will ensure a safer workplace for everyone. Brady has broken down the process for Lockout Tagout OSHA compliance into five easy steps, each with their own effective elements that add up to total workplace safety.



### Step 1:

Develop and document your equipment energy control policy/program



### Step 2:

Create and post written, visual equipment-specific lockout procedures



### Step 3:

Identify and mark all energy control points



### Step 4:

Train your employees, communicate and conduct periodic inspections

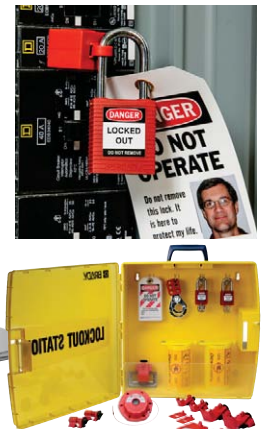

### Step 5:

Equip your employees with the proper lockout tools and warning devices



## Learn More: Download the 5 Steps To An Effective Lockout Program Whitepaper

Download the full whitepaper today for more information and details on each of these five steps.

Visit [BradyID.com/5steps](http://BradyID.com/5steps) to download the whitepaper.





## OSHA Lockout Tagout Regulations

OSHA's Volume 29 Code of Federal Regulation (CFR) 1910.147 standard addresses the control of hazardous energy when servicing or maintaining equipment.

- (1) Scope. (i) This standard covers the servicing and maintenance of machines and equipment in which the unexpected energization or start up of the machines or equipment, or release of stored energy could cause injury to employees. This standard establishes minimum performance requirements for the control of such hazardous energy.
- (2) Application. (i) This standard applies to the control of energy during servicing and / or maintenance of machines and equipment.
- (3) Purpose. (i) This section requires employers to establish a program and utilize procedures for affixing appropriate lockout devices or tagout devices to energy isolating devices, and to otherwise disable machines or equipment to prevent unexpected energization, start-up or release of stored energy in order to prevent injury to employees.



### 1910.147(c) OSHA Energy Control Policy; Synopsis of Requirements

An energy control policy must be documented and at a minimum should cover the following aspects of the program:

- Purpose and scope of the program
- Personnel authorized to perform LOTO
- Enforcement policy
- Training methods
- Group lockout procedures
- Shift transfer procedures
- Lock removal procedures
- Method for auditing & updating procedures
- Coordination with outside contractors



### 1910.147(c)(4) Energy Control Procedures; Synopsis of Requirements

- Procedures must be documented and must identify the equipment covered.
- A separate procedure must be created for each piece of equipment to be locked out. There are exceptions where multiple machines may be grouped under a single procedure.
- The procedure must include specific steps for shutting down, isolating, blocking and securing equipment to control hazardous energy.
- Specific steps for the placement, removal and transfer of Lockout Tagout devices should also be included.
- The employer shall conduct and certify periodic inspections at least annually.



### 1910.147(c)(5) OSHA Lockout Device Requirements

Lockout devices must:

- Be provided by the employer.
- Be standardized by size, shape or color.
- Be distinguishable from locks used for other purposes. Lockout locks should only be used for lockout!
- Identify the individual who applied the lock (both tags and lock labels are acceptable for this purpose).
- Be durable.
- Be strong enough to prevent removal except by using excessive force.
- Remain under the exclusive control of the individual who attached them.

#### 1910.147(c)(5)(ii)(B) Standardized

Lockout and tagout devices shall be standardized within the facility in at least one of the following criteria: Color; shape; or size; and additionally, in the case of tagout devices, print and format shall be standardized.

#### 1910.147(c)(5)(ii)(A) Durable

Lockout and tagout devices shall be capable of withstanding the environment to which they are exposed for the maximum period of time that exposure is expected.



# Standard Combination Lockout Kits

BradyID.com/lockouttagout

## Standard Combination Lockout Kits

These combination lockout kits can be purchased with or without padlocks and tags. Padlocks included in these kits are keyed differently (each lock has its own unique key). See the Personal Lockout Kits section for kits with keyed alike padlocks.



### Combination Lockout Satchel

- Everything you need to lock out the most common mechanical and electrical control points, with extra valve lockout devices
- Components:
  - 1 - Large Univ. Valve Lockout w/ Blocking Arm (50899 and 65403)
  - 1 - All Purpose Cable Lockout w/ 8' Sheathed Cable (50943)
  - 1 - 1/4" to 1" Ball Valve Lockout (65666)
  - 1 - 1" to 2-1/2" Gate Valve Lockout (65560)
  - 1 - 2-1/2" to 5" Gate Valve Lockout (65561)
  - 1 - 5" to 6-1/2" Gate Valve Lockout (65562)
  - 1 - 120V Snap-On Breaker Lockout (65387)
  - 1 - 120/277V Clamp-On Breaker Lockout w/ Cleat (65396)
  - 1 - 480/600V Clamp-On Breaker Lockout w/ Cleat (65397)
  - 1 - Universal Multi-Pole Breaker Lockout (66321)
  - 1 - 110V Electrical Plug Lockout (65674)
  - 1 - Wall Switch Lockout (65392)
  - 1 - Lockout Satchel (51173)
  - Optional:
    - 2 - Keyed-different safety padlocks (99552) or steel padlocks (99500)
    - 2 - Heavy duty, re-usable lockout tags (65520) and nylon cable ties

Catalog #	Description
99686	Combination Lockout Satchel Kit
99687	Kit w/2 Safety Padlocks & 2 Tags
99688	Kit w/2 Steel Padlocks & 2 Tags



### Combination Lockout Toolbox

- Contains all of the basic tools needed to lock out gate and ball valves, circuit breakers, switches and plugs
- Components:
  - 1 - 1" to 6-1/2" Adjustable Gate Valve Lockout (64057)
  - 1 - 1/4" to 1" Ball Valve Lockout (65666)
  - 1 - 1-1/4" to 3" Ball Valve Lockout (65669)
  - 1 - 120V Snap-On Breaker Lockout (65387)
  - 1 - 120/277V Clamp-On Breaker Lockout w/ cleat (65396)
  - 1 - 480/600V Clamp-On Breaker Lockout w/ cleat (65397)
  - 1 - Universal Multi-Pole Breaker Lockout (66321)
  - 1 - 110V Electrical Plug Lockout (65674)
  - 1 - Wall Switch Lockouts (65392)
  - 1 - Lockout Belt Pouch (51172)
  - 1 - Extra-Large Lockout Toolbox (LKP-TKLBOX)
  - Optional:
    - 2 - Keyed-different safety padlocks (99552) or steel padlocks (99500)
    - 2 - Heavy duty, re-usable lockout tags (65520) and nylon cable ties

Catalog #	Description
99682	Combination Lockout Toolbox Kit
99684	Kit w/2 Safety Padlocks & 2 Tags
99685	Kit w/2 Steel Padlocks & 2 Tags



### Brady Maintenance Lockout Kit

- Lockout kit specifically designed for use by internal maintenance crews
- Components:
  - 1 - 1/2" to 2-1/2" Small Ball Valve Lockout (BS07A)
  - 1 - 1" to 2.5" Gate Valve Lockout (65560)
  - 1 - 2.5" to 5" Gate Valve Lockout (65561)
  - 1 - All Purpose Cable Lockout (50943)
  - 1 - 3-in-1 Electrical Plug Lockout (PLO23)
  - 1 - Wall Switch Lockout (65392)
  - 2 - 120/277V Clamp-On Breaker Lockouts w/ Cleats (65396)
  - 2 - Universal Multi-Pole Breaker Lockouts (66321)
  - 1 - 110V Electrical Plug Lockout (65674)
  - 1 - AC Sensor (65269)
  - 10 - Lockout Danger Tags (LT10)
  - 1 - 1" Steel Lockout Hasp (T218)
  - 1 - 1-1/2" Steel Lockout Hasp (T220)
  - 3 - 3/4" Brady Key-Retaining Steel Padlocks, Blue, Keyed Different (143130)
  - 1 - Sheet of Lock Labels (LID-2)
  - 1 - Lockout Safety Training Booklet (2112X)
  - 1 - Plastic Utility Box (LKP-TKLBOX)

Catalog #	Description
134032	Brady Maintenance Lockout Kit

## View individual devices:

- Padlocks ..... page 464
- Gate Valve Lockouts ..... page 477
- Mini Cable Lockout ..... page 475
- Plug Valve Lockout ..... page 477
- Cable Lockout ..... page 475
- Breaker Lockouts ..... page 483
- Ball Valve Lockouts ..... page 477
- Fuse Lockouts ..... page 486





# Standard Combination Lockout Kits

BradyID.com/lockouttagout



## Prinzing Premium Lockout Kit

- Premium portable lockout kit that contains a large variety of electrical and mechanical lockout devices, tags, and labels
- Components:
  - 2 - Breaker Lockouts, Multi-pole (BL07)
  - 3 - Breaker Lockouts, Single pole (BL01)
  - 1 - 1" to 2.5" Gate Valve Lockout (65560)
  - 1 - 2.5" to 5" Gate Valve Lockout (65561)
  - 1 - Cable Lockout Device (CABLO)
  - 1 - Wall Switch Lockout (WSLO)
  - 1 - 3-in-1 Electrical Plug Lockout (PLO23)
  - 1 - 120-600 AC Voltage Sensor (ESAC600)
  - 3 - 1-1/2" Steel Lockout Hasps (T220)
  - 5 - Lockout Labels "Lock Out Before Servicing" (LOS15)
  - 5 - Lockout Labels "Lock Out Here" (LOS14)
  - 5 - Lockout Labels "Caution This Machine Must Be Locked Out" (LOS2) 20 - Lockout Tags (LT10)
  - 14 - Padlock Labels (LID-2)
  - 3 - Key-Retaining Steel Padlocks, 3/4" Shackle, Blue, Keyed Different (143130)
  - 1 - Lockout Safety Training Booklet (2112X)
  - 1 - Extra-Large Lockout Toolbox (LKP-TKLBOX)

Catalog #	Description
LKP	Prinzing Premium Lockout Kit



## Prinzing Ultimate Lockout Kit

- Ultimate portable lockout kit contains a variety of lockout devices for electrical and mechanical applications
- Components:
  - 1 - Safetee™ Donut 1" to 2-1/2" (SD02)
  - 1 - Safetee™ Donut 5" to 6-1/2" (SD06)
  - 1 - Ball Valve Lockout (BS07A)
  - 1 - Ball Valve Lockout (BS08A)
  - 1 - Electrical Plug / Pneumatic Lockout (PLO27E)
  - 1 - Cable Lockout Device (CABLO)
  - 2 - No-hole Breaker Lockout (BL04)
  - 2 - Breaker Lockout, Triple-pole (BL03)
  - 1 - Breaker Lockout, Multi-pole (BL07)
  - 2 - 1-1/2" Steel Lockout Hasp (T220)
  - 1 - Wall Switch Lockout (WSLO)
  - 10 - "Danger Do Not Operate" Lockout Tags (LT10)
  - 1 - Lockout Safety Training Booklet (2112X)
  - 1 - 120-600 AC Voltage Sensor (ESAC600)
  - 3 - Prinzing Padlocks 3/4" Blue (LC041-BU)
  - 1 - Lockout Bag "Duffel Style" (LX980E)

Catalog #	Description
LK981E	Ultimate Lockout Kit
LK980E	Lockout Bag Only



## Combination Lockout Duffel

- Everything you need to lock out the most common mechanical and electrical control points, with extra electrical lockout devices
- Components:
  - 1 - Mini Cable Lockout (50940)
  - 1 - 120V Snap-On Breaker Lockout (65387)
  - 1 - 120/277V Clamp-On Breaker Lockout (65396)
  - 1 - 480/600V Clamp-On Breaker Lockout (65397)
  - 1 - Universal Multi-Pole Breaker Lockout (66321)
  - 1 - Oversized Breaker Lockout (65329)
  - 1 - 3-in-1 Electrical Plug Lockout (PLO23)
  - 1 - Wall Switch Lockout (65392)
  - 1 - Plug Valve Lockout for stem dia up to 7/8" (113231)
  - 1 - Plug Valve Lockout for stem dia 29/32" to 1-3/8" (113232)
  - 1 - 1" to 6-1/2" Adjustable Gate Valve Lockout (64057)
  - 1 - 1" to 2-1/2" Gate Valve Lockout (65560)
  - 1 - 1/4" to 1" Ball Valve Lockout (65666)
  - 1 - Large Univ. Valve Lockout w/ Blocking Arm (50899 and 65403)
  - 1 - Lockout Belt Pouch (51172)
  - 1 - Lockout Duffel Bag (99162)
  - Optional:
    - 2 - Keyed-different safety padlocks (99552) or steel padlocks (99500)
    - 2 - Heavy duty, re-usable lockout tags (65520) and nylon cable ties

Catalog #	Description
99689	Combination Lockout Duffel Kit
99690	Kit w/2 Safety Padlocks & 2 Tags
99691	Kit w/2 Steel Padlocks & 2 Tags

## Lockout Kit - Spanish

- Everything you need to lockout electrical and mechanical isolation points. All contents come with Spanish legends.
- Components:
  - 2 - 1-1/4" to 3" Steel Ball Valve Lockout (65669)
  - 2 - 1/4" to 1" Nylon Ball Valve Lockout (65666)
  - 2 - 1" to 2.5" Gate Valve Lockouts (65560)
  - 2 - 2.5" to 5" Gate Valve Lockouts (65561)
  - 1 - 110V Electrical Plug Lockout (65674)
  - 1 - 220/550V Electrical Plug Lockout (65675)
  - 6 - Wall Switch Lockouts (65392)
  - 6 - 120V Snap-On Breaker Lockout (65387)
  - 6 - 120/277V Clamp-On Breaker Lockouts (65396)
  - 6 - Universal Multi-Pole Breaker Lockouts (66321)
  - 5 - Aluminum Spanish Labeled Lockout Hasp
  - 25 - Spanish Lockout Danger Tags w/ Cable Ties
  - 6 - Brady Steel Padlocks, 3/4" Shackle, Blue, Keyed Different (99504)
  - 6 - Brady Steel Padlocks, 2" Shackle, Blue, Keyed Different (99528)
  - 2 - Lockout Canvas Security Bags (65780)

Catalog #	Description
65043	Lockout Kit - Spanish



# Standard Electrical Lockout Kits

BradyID.com/lockouttagout

## Standard Electrical Lockout Kits

Standard electrical lockout kits can be purchased with or without padlocks and tags. The padlocks included in these kits are keyed differently (each lock has its own unique key). See the Personal Lockout Kits section for kits with keyed alike padlocks.



### Portable Padlock Pouch

- Portable kit includes selection of padlocks, tags and hasps
- Components:
  - 2 - Keyed-different safety padlocks (99552) or steel padlocks (99500). Padlocks include 2 heavy duty, re-usable lockout tags (65520) and nylon cable ties.
  - 1 - 1" Group Lockout Hasp (65375)
  - 1 - 1-1/2" Group Lockout Hasp (65376)
  - 1 - Lockout Belt Pouch (51172)

Catalog #	Description
99290	Kit w/2 Safety Padlocks
99292	Kit w/2 Steel Padlocks



### Electrical Power Pouch Kit

- Versatile lockout pouch contains useful electrical lockout devices and padlocks
- Components:
  - 2 - Lockout Tags
  - 1 - StoPower Electrical Plug Lockout (65673)
  - 1 - Wall Switch Lockout (65392)
  - 1 - 110V Electrical Plug Lockout (65674)
  - 1 - 1" Steel Safety Lockout Hasp (65375)
  - 1 - Lockout Pouch (87943)

Catalog #	Description
95548	Electrical Power Pouch Kit
95550	Kit w/ 1 Red Brady Safety Padlock



### Breaker Lockout Pouch

- Versatile lockout pouch contains the most commonly used electrical lockout devices
- Components:
  - 1 - Universal Multi-Pole Breaker Lockout (66321)
  - 1 - 120/277V Clamp-On Breaker Lockout (65396)
  - 1 - 480/600V Clamp-On Breaker Lockout (65397)
  - 1 - 110V Electrical Plug Lockout
  - 1 - 1" Steel Lockout Hasp
  - 1 - Lockout Pouch (87943)

Catalog #	Description
95553	Breaker Lockout Pouch



### Breaker Lockout Pouch Kit

- Contains our most popular circuit breaker lockouts
- Components:
  - 1 - Universal Multi-Pole Breaker Lockout (66321)
  - 1 - 120/277V Clamp-On Breaker Lockout w/ cleat (65396)
  - 1 - 480/600V Clamp-On Breaker Lockout w/ cleat (65397)
  - 1 - 120V Snap-On Breaker Lockout (65387)
  - 2 - Lockout Tags
  - 1 - Brady Safety Padlock, Red (99552)
  - 1 - Lockout Pouch (87943)

Catalog #	Description
95538	Breaker Lockout Pouch Kit



### 120/277V Breaker Lockout Pouch

- All the devices you need to lockout most 120/277V circuit breakers
- Components:
  - 2 - 120V Snap-On Breaker Lockouts (65387)
  - 2 - 120/277V Clamp-On Breaker Lockout w/Cleats (65396)
  - 2 - Universal Multi-Pole Breaker Lockout w/Cleats (66321)
  - 1 - Lockout Belt Pouch (51172)
- Optional: 2 - Keyed-different safety padlocks (99552) or steel padlocks (99500). And 2 heavy duty, re-usable lockout tags (65520) and nylon cable ties.

Catalog #	Description
99300	120/277V Breaker Lockout Pouch Kit
99302	Kit w/2 Safety Padlocks & 2 Tags
99303	Kit w/2 Steel Padlocks & 2 Tags



### Breaker Lockout Sampler Pouch

- One each of our most popular circuit breaker lockouts
- Components:
  - 1 - 120V Snap-On Breaker Lockout (65387)
  - 1 - 120/277V Clamp-On Breaker Lockout w/cleat (65396)
  - 1 - 480/600V Clamp-On Breaker Lockout w/cleat (65397)
  - 1 - Universal Multi-Pole Breaker Lockout (66321)
  - 1 - Oversized Breaker Lockout (65329)
  - 1 - Lockout Belt Pouch (51172)
- Optional: 2 - Keyed-different safety padlocks (99552) or steel padlocks (99500). And 2 heavy duty, re-usable lockout tags (65520) and nylon cable ties.

Catalog #	Description
99293	Breaker Lockout Sampler Toolbox Kit
99296	Kit w/2 Safety Padlocks & 2 Tags
99297	Kit w/2 Steel Padlocks & 2 Tags

# Standard Electrical Lockout Kits

BradyID.com/lockouttagout



## Electrical Lockout Pouch

- Lightweight, portable pouch contains lockout devices to secure electrical equipment. Convenient metal loops on pouch allow pouch to hang on belt.
- Components:
  - 1 - 120/277V Clamp-On Breaker Lockout (65396)
  - 1 - Universal Multi-Pole Breaker Lockout (66321)
  - 1 - 110V Electrical Plug Lockout (65674)
  - 2 - Lockout Danger Tags
  - 1 - Aluminum Labeled Lockout Hasp
  - 1 - Brady Steel Padlock, 2" Shackle, Blue (99528)
  - 1 - Lockout Pouch (65292)

Catalog #	Description
65291	Electrical Lockout Pouch



## Comprehensive Breaker Lockout Pouch

- Lightweight, portable pouch contains lockout devices to secure electrical equipment. Convenient metal loops on pouch allow pouch to hang on belt.
- Components:
  - 1 - 110V Electrical Plug Lockout (65674)
  - 3 - Wall Switch Lockouts (65392)
  - 3 - Universal Multi-Pole Breaker Lockouts (66321)
  - 3 - 120/277V Clamp-On Breaker Lockout w/Cleat (65396)
  - 2 - 480/600V Clamp-On Breaker Lockout w/Cleat (65397)
  - 1 - 120/277V Additional Cleat (102721)
  - 1 - 480/600V Additional Cleat (102722)
  - 1 - Lockout Pouch (65292)

Catalog #	Description
65405	Comprehensive Breaker Lockout Pouch



## Brady Electrical Lockout Pouch Kit

- Compact and easy to use lockout pouch with the most common electrical devices
- Components:
  - 1 - 120/277V Clamp-On Breaker Lockout w/ cleats (65396)
  - 1 - 120V Snap-On Breaker Lockout (65387)
  - 1 - 110V Electrical Plug Lockout (65674)
  - 1 - Universal Multi-Pole Breaker Lockout (66321)
  - 1 - Wall Switch Lockout (65392)
  - 10 - Lockout Danger Tags (LT10)
  - 1 - 1-1/2" Steel Lockout Hasp (T220)
  - 1 - Brady Key-Retaining Steel Padlock, 3/4" Shackle, Blue (143130)
  - 1 - Large Lockout Pouch

Catalog #	Description
134031	Brady Electrical Lockout Pouch Kit



## Brady Breaker Lockout Pouch Kit

- Compact and easy to use lockout pouch with the most common circuit breaker lockout devices
- Components:
  - 2 - 120V Snap-On Circuit Breaker Lockouts (65387)
  - 2 - 120/277V Clamp-On Breaker Lockouts w/ cleats (65396)
  - 2 - Universal Multi-Pole Breaker Lockouts (66321)
  - 1 - Oversized Breaker Lockout (65329)
  - 10 - Lockout Danger Tags (LT10)
  - 1 - 1-1/2" Steel Lockout Hasp (T220)
  - 1 - Brady Key Retaining Steel Padlock, 3/4" Shackle, Blue (143130)
  - 1 - Large Lockout Pouch

Catalog #	Description
134034	Brady Breaker Lockout Pouch Kit

Lockout Tagout



# Standard Electrical Lockout Kits

BradyID.com/lockouttagout



## Brady Lockout Kit With Large Box

- Versatile lockout kit with essential lockout tagout components
- Components:
  - 3 - 120V Snap-On Breaker Lockouts (65387)
  - 1 - 3-in-1 Electrical Plug Lockout (PLO23)
  - 2 - Universal Multi-Pole Breaker Lockouts (66321)
  - 1 - Sheet of Lock Labels (LID-2)
  - 10 - Lockout Danger Tags (LT10)
  - 3 - 1-1/2" Steel Lockout Hasps (T220)
  - 1 - Lockout Safety Training Booklet (2112X)
  - 1 - Plastic Utility Box

Catalog #	Description
134035	Brady Lockout Kit With Large Box



## Basic Electrical Lockout Toolbox

- A handy, basic lockout toolbox kit that includes your most commonly used electrical devices
- Components:
  - 1 - 1" to 2.5" Gate Valve Lockout (65560)
  - 1 - 1/4" to 1" Ball Valve Lockout (65666)
  - 1 - Small 110V Electrical Plug Lockout (65674)
  - 1 - 120/277V Clamp-On Breaker Lockouts w/cleats (65396)
  - 1 - 480/600V Clamp-On Breaker Lockouts w/cleats (65397)
  - 1 - Wall Switch Lockout (65392)
  - 1 - Universal Multi-Pole Breaker Lockout (66321)
  - 1 - Labeled Group Lockout Hasp (65960)
  - 5 - Lockout Tags (65525)
  - 1 - 3/4" Steel padlock, blue (99504)
  - 1 - 2" Steel padlock, blue (99528)
  - 1 - Lockout Toolbox (65290)

Catalog #	Description
65289	Basic Electrical Lockout Toolbox



## Electrical Lockout Starter Kit

- Contains everything you need to mark and secure a variety of electrical components to protect employees from electrical hazards
- Components:
  - 1 - Small 110V Electrical Plug Lockout (65674)
  - 1 - Large 220/500V Electrical Plug Lockout (65675)
  - 6 - Wall Switch Lockouts (65392)
  - 6 - 120V Snap-On Breaker Lockouts (65387)
  - 6 - 120/277V Clamp-On Breaker Lockouts w/cleats (65396)
  - 6 - Universal Multi-Pole Breaker Lockouts (66321)
  - 3 - Labeled Group Lockout Hasps (65960 English / 39480 Spanish)
  - 10 - Lockout Tags with Cable Ties. Tag Legend options:
    - Danger Do Not Operate
    - Peligro No Operar
    - Precaucion No Hacer Funcionar
  - 2 - 3/4" Shackle Brady Steel Padlock, Blue (99504)
  - 2 - 2" Shackle Brady Steel Padlock, Blue (99528)
  - 1 - Canvas Lockout Bag (65780)

Catalog #	Description
65777	English Electrical Lockout Starter Kit ("Danger Do Not Operate" Tags)
121510	Spanish Electrical Lockout Starter Kit ("Precaucion No Hacer Funcionar" Tags)
121513	Spanish Electrical Lockout Starter Kit ("Peligro No Operar" Tags)

**?** **View individual devices:**

- Padlocks ..... page 464
- Mini Cable Lockout ..... page 475
- Cable Lockout ..... page 475
- Ball Valve Lockouts ..... page 477
- Gate Valve Lockouts ..... page 477
- Plug Valve Lockout ..... page 477
- Breaker Lockouts ..... page 483
- Fuse Lockouts ..... page 486

# Standard Electrical Lockout Kits

BradyID.com/lockouttagout



## Lockout Toolbox With Components

- Economical lockout toolbox with the most common electrical circuit breaker lockouts
- Components:
  - 1 - Large 220/550V Electrical Plug Lockout (65675)
  - 1 - 120/277V Clamp-On Breaker Lockouts w/cleats (65396)
  - 1 - 480/600V Clamp-On Breaker Lockouts w/cleats (65397)
  - 1 - Universal Multi-Pole Breaker Lockout (66321)
  - 2 - Lockout Tags
  - 1 - Brady Safety Padlock, Red (99552)
  - 1 - Lockout Toolbox (65290)

Catalog #	Description
95540	Lockout Toolbox With Components



## Breaker Lockout Toolbox

- Everything you need to lockout most circuit breakers
- Components:
  - 1 - Mini Cable Lockout (50940)
  - 2 - 120V Snap-On Breaker Lockout (65387)
  - 2 - 120/277V Clamp-On Breaker Lockouts w/cleats (65396)
  - 2 - 480/600V Clamp-On Breaker Lockouts w/cleats (65397)
  - 1 - Universal Multi-Pole Breaker Lockout (66321)
  - 1 - Oversized Breaker Lockout (65329)
  - 1 - Lockout Toolbox (65290)
  - Optional: 2 - Keyed-different safety padlocks (99552) or steel padlocks (99500). And 2 heavy duty, re-usable lockout tags (65520) and nylon cable ties.

Catalog #	Description
99305	Breaker Lockout Toolbox Kit
99307	Kit w/2 Safety Padlocks & 2 Tags
99308	Kit w/2 Steel Padlocks & 2 Tags



Optional Sign & Rack

## Prinzing Lockout Kits

- Ensure equipment is de-energized or locked out in accordance with OSHA regulations
- Sign & Rack also available to conveniently hold the kit
- Components:
  - 3 - 1-1/2" Steel Lockout Hasps (T220)
  - 3 - Blue Prinzing Padlocks (LC041-BU)
  - 14 - 2 Padlock Identifier Stickers (LID-2)
  - 1 - pkg. (10) - Lockout Tags with Ties (LT10)
  - 3 - Single Pole Breaker Lockouts (BLO1)
  - 2 - Multi Pole Breaker Lockouts (BLO3)
  - 1 - 3-in-1 Electrical Plug Lockout (PLO23)
  - 1 - Lockout Training Booklet (2112X)
  - 1 - Toolbox (7"H x 12"W x 5"D)
  - Optional: 1 Sign & Storage Rack (LXX-Rack)

Catalog #	Description
LKXSET	Lockout Kit w/Toolbox and Sign & Storage Rack
LKX	Economy Lockout Kit w/Toolbox
LKX-Rack	Sign & Rack only



## Electrical Lockout Toolbox

- Contains all of the basic devices needed to lock out circuit breakers, electrical plugs, wall switches and fuses
- Components:
  - 1 - Mini Cable Lockout (50940)
  - 2 - 120V Snap-On Breaker Lockouts (65387)
  - 2 - 120/277V Clamp-On Breaker Lockouts w/cleats (65396)
  - 2 - 480/600V Clamp-On Breaker Lockouts w/cleats (65397)
  - 2 - Universal Multi-Pole Breaker Lockouts (66321)
  - 2 - Cleats for 120/277V Clamp-On Lockouts (65404)
  - 2 - Cleats for 480/600V Clamp-On Lockouts (65406)
  - 1 - Oversized Breaker Lockout (65329)
  - 1 - 3-in-1 Electrical Plug Lockout (PLO23)
  - 1 - Wall Switch Lockout (65392)
  - 1 - Small Fuse Blockout (65690)
  - 1 - Large Fuse Blockout (65691)
  - 1 - Extra-Large Lockout Toolbox (LKP-TKLBOX)
  - 1 - Red Belt Pouch (51172)
  - Optional: 2 - Keyed-different safety padlocks (99552) or steel padlocks (99500). And 2 heavy duty, re-usable lockout tags (65520) and nylon cable ties.

Catalog #	Description
99310	Electrical Lockout Toolbox Kit
99312	Kit w/2 Safety Padlocks & 2 Tags
99313	Kit w/2 Steel Padlocks & 2 Tags

# Standard Valve Lockout Kits

BradyID.com/lockouttagout

## Standard Valve Lockout Kits

The valve lockout kits can be purchased with or without padlocks and tags. The padlocks included in these kits are keyed differently (each lock has its own unique key). For kits with keyed-alike padlocks (all locks can be opened with the same key), see the Personal Lockout Kits section.



### Valve Lockout Pouch

- Components:
  - 1 - 1" to 6-1/2" Adjustable Gate Valve Lockout (64057)
  - 2 - 1/2" to 2-1/2" Small Ball Valve Lockout (BS07A)
  - 1 - Plug Valve Lockout for stem dia up to 7/8" (113231)
  - 1 - Plug Valve Lockout for stem dia 29/32" to 1-3/8 (113232)
  - 1 - Large Lockout Pouch (50979)
  - Optional: 2 - Keyed-different safety padlocks (99552) or steel padlocks (99500). And 2 heavy duty, re-usable lockout tags (65520) and nylon cable ties.

Catalog #	Description
99679	Valve Lockout Pouch Kit
99680	Kit w/2 Safety Padlocks & 2 Tags
99681	Kit w/2 Steel Padlocks & 2 Tags



### Gate Valve Lockout Pouch

- Components:
  - 1 - 1" to 6-1/2" Adjustable Gate Valve Lockout (64057)
  - 1 - All Purpose Cable Lockout w/ 8" sheathed cable (50943)
  - 1 - Nylon Carrying Case (50979)
  - Optional: 2 - Keyed-different safety padlocks (99552) or steel padlocks (99500). And 2 heavy duty, re-usable lockout tags (65520) and nylon cable ties.

Catalog #	Description
101416	Gate Valve Lockout Pouch Kit
102692	Kit w/2 Safety Padlocks & 2 Tags
102693	Kit w/2 Steel Padlocks & 2 Tags



### Gate Valve Lockout Satchel

- Components:
  - 1 - 1" to 2-1/2" Gate Valve Lockout (65560)
  - 1 - 2-1/2" to 5" Gate Valve Lockout (65561)
  - 1 - 5" to 6-1/2" Gate Valve Lockout (65562)
  - 1 - 6-1/2" to 10" Gate Valve Lockout (65563)
  - 1 - XL Gate Valve Lockout (65564)
  - 1 - Lockout Satchel (51173)
  - Optional: 2 - Keyed-different safety padlocks (99552) or steel padlocks (99500). And 2 heavy duty, re-usable lockout tags (65520) and nylon cable ties.

Catalog #	Description
99676	Gate Valve Lockout Satchel Kit
99677	Kit w/2 Safety Padlocks & 2 Tags
99678	Kit w/2 Steel Padlocks & 2 Tags

**? Keyed Alike Padlocks**

See the Personal Lockout Kits section for kits with keyed alike padlocks.

# Standard Valve Lockout Kits

BradyID.com/lockouttagout



## Brady Valve Lockout Kit

- The essential lockout devices needed for the most common valves in your facility
- Components:
  - 1 - 2.3" to 5" Gate Valve Lockout (65561)
  - 10 - 7" Red Cable Ties (FT100X-RED)
  - 1 - All Purpose Cable Lockout (50943)
  - 2 - 1/2" to 2-1/2" Small Ball Valve Lockout (BS07A)
  - 10 - Bilingual Lockout Tags (TG400B-ONE)
  - 2 - 1-1/2" Steel Lockout Hasp (T220)
  - 2 - 3/4" Brady Key-Retaining Steel Padlocks, Blue, Keyed Different (143130)
  - 1 - Plastic Utility Box (LKP-TKLBOX)

Catalog #	Description
134033	Brady Valve Lockout Kit



## Valve Lockout Toolbox

- Everything you need to lock out gate, ball and butterfly valves
- Components:
  - 1 - Small Univ. Valve Lockout w/ Blocking Arm (50924 and 65402)
  - 1 - All Purpose Cable Lockout w/ 8' Sheathed Cable (50943)
  - 1 - 1" to 6-1/2" Adjustable Gate Valve Lockout (64057)
  - 1 - 1/4" to 1" Ball Valve Lockout (65666)
  - 1 - 1" to 2-1/2" Gate Valve Lockout (65560)
  - 1 - Extra-Large Lockout Toolbox (LKP-TKLBOX)
  - Optional: 2 - Keyed-different safety padlocks (99552) or steel padlocks (99500). And 2 heavy duty, re-usable lockout tags (65520) and nylon cable ties.

Catalog #	Description
99320	Gate Valve Lockout Toolbox Kit
99321	Kit w/2 Safety Padlocks & 2 Tags
99324	Kit w/2 Steel Padlocks & 2 Tags



## New Lockout Tagout Technical Data Sheets

Download the technical sheets for over 350 lockout SKUs including lockout devices and padlocks.

These sheets offer lots of information, including:

- Basic product description & photos
- Material information & temperature resistance
- Chemical resistance
- Detailed dimensional data
- MSDS information on the materials

To view all technical data sheets visit:

**BradyID.com/techdata**



Lockout Tagout



# Personal Lockout Kits

BradyID.com/lockouttagout

## Personal Lockout Kits

Personal lockout kits come equipped with keyed-alike padlocks, allowing all the locks in a kit to be opened with a single key. This simplifies key management and ensures that employees can quickly and easily find the right key. For kits containing padlocks that are keyed different (each padlock has its own unique key), see the standard lockout kits on previous pages. Or select a personal lockout kit without padlocks, and purchase the padlocks separately.



### Personal Padlock Pouch

- Components:
  - 2 - 1" Group Lockout Hasps (65375)
  - 2 - Heavy Duty Lockout Tags (65520) w/ Nylon Cable Ties
  - 2 - Keyed-alike Safety Padlocks (99552) or Steel Padlocks (99500)
  - 1 - Lockout Belt Pouch (51172)

Catalog #	Description
105969	Padlock kit w/ Keyed-Alike Safety Padlocks
105970	Padlock kit w/ Keyed-Alike Steel Padlocks



### Brady Operator Lockout Tagout Kit

- Components:
  - 1 - Lockout Safety Card
  - 1 - Lockout Danger Tag
  - 1 - 1-1/2" Steel Lockout Hasp (T220)
  - 1 - 120/277V Clamp-On Breaker Lockout w/ cleats (65396)
  - 1 - Brady Safety Padlock, Black (99580)
  - 1 - Plastic Box

Catalog #	Description
134030	Brady Operator Lockout Tagout Kit



### Prinzing Standard Lockout Belt Pack

- Components:
  - 1 - Lockout Safety Card
  - 2 - Lockout "Danger" Tags
  - 1 - Lockout Keychain
  - 2 - 7" Red Cable Ties (FT100X-RED)
  - 1 - 1-1/2" Steel Lockout Hasp (T220)
  - 1 - 1.5" Aluminum red padlock (99615)
  - 1 - Lockout Pouch (LKPOUCH)

Catalog #	Description
LK627E	Prinzing Standard Lockout Belt Pack



### Personal Breaker Lockout Pouch

- Covers 120/277v and 480/600v breakers in single- and multi-pole configurations.
- Components:
  - 1 - 120/277V Clamp-On Breaker Lockout w/Cleat (65396)
  - 1 - 480/600V Clamp-On Breaker Lockout w/Cleat (65397)
  - 1 - Universal Multipole Breaker Lockout (66321)
  - 2 - 1" Group Lockout Hasps (65375)
  - 2 - Heavy Duty Lockout Tags (65520) w/ Nylon Cable Ties
  - 1 - Lockout Belt Pouch (51172)
  - Optional: 2 - Keyed-alike Safety Padlocks (99552) or Steel Padlocks (99500)

Catalog #	Description
105966	Personal Breaker Lockout Pouch Kit
105967	Kit w/ 2 Keyed-Alike Safety Padlocks
105968	Kit w/ 2 Keyed-Alike Steel Padlocks



### Prinzing Cable Lockout Kit

- Components:
  - 2 - Cable Lockout Devices (CABLO)
  - 2 - Blue Prinzing Padlocks (LC041-BU)
  - 1 - 1" Steel Lockout Hasp (T218)
  - 2 - Eng/Sp Lockout Tags w/ Ties
  - 1 - Rugged Polyethylene Carrying Case (7"H x 12"W x 5"D)

Catalog #	Description
LK520B	Cable Lockout Kit



### Prinzing Chain Lockout Kit

- Components:
  - 3 - 1-1/2" Steel Lockout Hasp (T220)
  - 3 - Padlocks (LCO44-RD)
  - 3 - Lockout Tags w/Ties
  - 1 - 48" Chain
  - 1 - Durable Carrying Case (7"H x 12"W x 5"D)

Catalog #	Description
LK041R	Lockout Kit w/ 1 Chain
LK042R	Lockout Kit w/ 2 Chains





## Personal Basic Lockout Kit

- Contains the basic devices needed to lockout common circuit breakers, valves and plugs
- Components:
  - 1 - 1/2" to 2-1/2" Small Ball Valve Lockout (BS07A)
  - 1 - 1" to 2-1/2" Gate Valve Lockout (65560)
  - 1 - 120/277V Clamp-On Breaker Lockout w/ Cleat (65396)
  - 1 - Universal Multipole Breaker Lockout (66321)
  - 1 - Small 110V Electrical Plug Lockout (65674)
  - 2 - 1" Lockout Hasps (65375)
  - 2 - Heavy Duty Lockout Tags (65520) w/ Nylon Cable Ties
  - 1 - Small Lockout Toolbox (105905)
  - Optional: 2 - Keyed-alike Safety Padlocks (99552) or Steel Padlocks (99500)

Catalog #	Description
104794	Personal Basic Lockout Kit
104795	Kit w/ 2 Keyed-alike Safety Padlocks
104796	Kit w/ 2 Keyed-alike Steel Padlocks



## Personal Breaker Lockout Kit

- Tool box with 2 each of our most popular circuit breaker lockouts
- Covers 120/277v and 480/600v circuit breakers in single and multi pole configurations.
- Components:
  - 2 - 120/277V Clamp-On Breaker Lockouts w/ Cleats (65396)
  - 2 - 480/600V Clamp-On Breaker Lockouts w/ Cleats (65397)
  - 2 - Universal Multipole Breaker Lockouts (66321)
  - 3 - 1" Red Lockout Hasps (65375)
  - 3 - Heavy Duty Lockout Tags (65520) w/ Nylon Cable Ties
  - 1 - Small Lockout Toolbox (105905)
  - Optional: 3 - Keyed-alike Safety Padlocks (99552) or Steel Padlocks (99500)

Catalog #	Description
105963	Personal Breaker Lockout Kit
105964	Kit w/ 3 Keyed-Alike Safety Padlocks
105965	Kit w/ 3 Keyed-Alike Steel Padlocks



## Prinzing Basic Lockout Kit

- Rugged lockout toolbox kit with all of the basic components to get your lockout program started
- Components:
  - 5 - 7" Red Cable Ties (FT100X-RED)
  - 5 - Lockout Danger Tags
  - 3 - 1-1/2" Steel Lockout Hasps (T220)
  - 1 - Lockout Keychain
  - 2 - 4"x6" Magnetic Danger Sign
  - 1 - Lockout Miniposter (PS811B)
  - 1 - OSHA Lockout Summary Sheet
  - 1 - Number Sheets
  - 1 - Pad of Lockout Tagout Checklists (119076)
  - 1 - Red Metal Toolbox

Catalog #	Description
LK330E	Prinzing Basic Lockout Kit
LK907E	Kit w/3 Aluminum 1.5" Keyed Alike Red Padlocks



## Prinzing Lockout Kit

- Rugged lockout toolbox kit with all of the basic components to get your lockout program started
- Components:
  - 5 - 7" Red Cable Ties (FT100X-RED)
  - 5 - Lockout Danger Tags
  - 3 - 1-1/2" Steel Lockout Hasps (T220)
  - 1 - Lockout Keychain
  - 2 - 4"x6" Magnetic Danger Sign
  - 1 - Lockout Miniposter (PS811B)
  - 1 - OSHA Lockout Summary Sheet
  - 1 - Number Sheets
  - 1 - AC Sensor (65269)
  - 3 - Aluminum 1.5" Keyed Alike Red Padlocks
  - 1 - Red Metal Toolbox

Catalog #	Description
LK331E	Prinzing Lockout Kit



# Personal Lockout Kits

BradyID.com/lockouttagout



## Personal Electrical Lockout Kit

- Contains lockouts for use on most circuit breakers, electrical plugs and disconnect switches.
- Components:
  - 1 - Mini Cable Lockout (50940)
  - 1 - 3-in-1 Electrical Plug Lockout (PLO23)
  - 2 - 120/277V Clamp-On Breaker Lockouts w/ Cleats (65396)
  - 1 - 480/600V Clamp-On Breaker Lockout w/ Cleat (65397)
  - 2 - Universal Multipole Breaker Lockout (66321)
  - 1 - Oversized Breaker Lockout (65329)
  - 3 - 1" Group Lockout Hasps (65375)
  - 3 - Heavy Duty Lockout Tags (65520) w/ Nylon Cable Ties
  - 1 - Medium Lockout Toolbox (105906)
  - Optional: 3 - Keyed-alike Safety Padlocks (105886) or Steel Padlocks (118977)

Catalog #	Description
105960	Personal Electrical Lockout Kit
105961	Kit w/3 Keyed-alike Safety Padlocks
105962	Kit w/3 Keyed-alike Steel Padlocks



## Personal Valve Lockout Kit

- Contains lockouts for use on a wide range of gate and ball valves
- Components:
  - 1 - 1" to 6-1/2" Adjustable Gate Valve Lockout (64057)
  - 1 - 1" to 2-1/2" Gate Valve Lockout (65560)
  - 1 - 1/2" to 2-1/2" Small Ball Valve Lockout (BS07A)
  - 1 - All Purpose Cable Lockout (50943)
  - 3 - 1" Group Lockout Hasps (65375)
  - 3 - Heavy Duty Lockout Tags (65520) w/ Nylon Cable Ties
  - 1 - Medium Lockout Toolbox (105906)
  - Optional: 3 - Keyed-alike Safety Padlocks (105886) or Steel Padlocks (118977)

Catalog #	Description
105957	Personal Valve Lockout Kit
105958	Kit w/ 3 Keyed-Alike Safety Padlocks
105959	Kit w/ 3 Keyed-Alike Steel Padlocks



## Personal Valve & Electrical Lockout Kit

- Provides everything you need to lockout circuit breakers, plugs and valves of various types and sizes
- Components:
  - 1 - All Purpose Cable Lockout (50943)
  - 1 - 1" to 6-1/2" Adjustable Gate Valve Lockout (64057)
  - 1 - Plug Valve Lockout for stem dia up to 7/8" (113231)
  - 1 - Plug Valve Lockout for stem dia 9/32" to 1-3/8" (113232)
  - 1 - 1/2" to 2-1/2" Small Ball Valve Lockout (BS07A)
  - 1 - 3-in-1 Electrical Plug Lockout (PLO23)
  - 2 - 120/277V Clamp-On Breaker Lockouts w/ Cleats (65396)
  - 1 - 480/600V Clamp-On Breaker Lockout w/ Cleat (65397)
  - 2 - Universal Multipole Breaker Lockouts (66321)
  - 3 - 1" Group Lockout Hasps (65375)
  - 3 - Heavy Duty Lockout Tags (65520) w/ Nylon Cable Ties
  - 1 - Medium Lockout Toolbox (105906)
  - Optional: 3 - Keyed-alike Safety Padlocks (105886) or Steel Padlocks (118977)

Catalog #	Description
105954	Personal Valve & Electrical Kit
105955	Kit w/ 3 Keyed-Alike Safety Padlocks
105956	Kit w/ 3 Keyed-Alike Steel Padlocks

**?** **View individual devices:**

- Padlocks..... page 464
- Mini Cable Lockout..... page 475
- Cable Lockout..... page 475
- Ball Valve Lockouts ..... page 477
- Gate Valve Lockouts ..... page 477
- Plug Valve Lockout..... page 477
- Breaker Lockouts ..... page 483
- Fuse Lockouts ..... page 486

## Custom Lockout Storage

Create your custom lockout kits by picking one of the storage/carrying cases below and filling it with the lockout devices you need!



### Lockout Belt Pouch

- Made of heavy duty nylon with loops for hanging on a belt
- Dimensions: 4-3/4"H x 7-1/2"W x 2"D

Catalog #	Description
51172	Lockout Belt Pouch



### Large Lockout Pouch

- Made of nylon with attachment loop on back
- Dimensions: 8"H x 7"W x 3"D

Catalog #	Description
50979	Large Lockout Pouch w/ Plastic Zipper
121502	Large Lockout Pouch w/ Metal Zipper



### Lockout Security Bag

- Made of rugged canvas with drawstring
- Capable of being locked closed
- Dimensions: 9-3/4"H x 18"W

Catalog #	Description
65780	Lockout Security Bag



### Lockout Satchel

- Made of 1000 denier red cordura nylon with 39" shoulder strap
- Includes latchable front pocket and two side mesh holders
- Dimensions: 14"H x 4"W x 15"D

Catalog #	Description
51173	Lockout Satchel



### Extra-Large Lockout Toolbox

- Made of rugged polyethylene and includes a removable organizer tray
- Capable of being locked closed
- Dimensions: 5"H x 12"W x 7"D

Catalog #	Description
LKX-TKLBOX	Lockout Toolbox



### Lockout Duffel Bag

- Made of 600 denier polyester with 39" removable shoulder strap and 8 inside pockets
- Dimensions: 10"H x 16-1/2"W x 8-1/2"D

Catalog #	Description
99162	Lockout Duffel Bag



### Lockout Toolboxes

- Made of rugged polypropylene with nickel-plated steel clasps and removeable tray
- Two handy storage pockets built into lid
- Small: 7.1"H x 14"W x 5.5"D
- Medium: 7.8"H x 16.2"W x 7.3"D

Catalog #	Description
105905	Small Toolbox
105906	Medium Toolbox



### Prinzing Metal Lockout Cabinet

- All metal, yellow powder-coated cabinet comes with one adjustable shelf (extra shelves available)
- Capable of being locked closed
- Can also be easily wall mounted using predrilled holes in back
- Lockout safety tips printed on inside door
- Dimensions: 16"H x 14"W x 6"D

Catalog #	Description
LC252M	Metal Lockout Cabinet
LC254M	Extra Shelf



### Ready Access Lockout Station

- Made of thermformed polypropylene
- Semi-transparent hinged cover with locking mechanism
- Slots in back for wall mounting and carrying handle for easy portability
- 4 Small detachable hanging hooks
- Compartment: 4.25"H x 16"W x 5.12"D
- Dimensions: 17"H x 17"W x 6.75"D

Catalog #	Description
105942	Ready Access Lockout Station (empty)

# Lockout Stations

BradyID.com/lockouttagout



## Lockout Tagout Stations

Brady's Lockout Tagout Stations ensure that lockout devices are properly stored and always accessible when needed. These Lockout Tagout Stations are a great place to centralize lockout activity needs by organizing the tools, padlocks and padlock keys in one location. Available in portable and wall-mounted styles, these stations are designed with the durability required for an industrial workplace, and can be locked to prevent theft and unauthorized usage.

Lockout Tagout



## Combined Lockout / Group Lockout Box Station

- Lockable all metal, yellow powder-coated cabinet comes with one adjustable shelf (extra shelves available)
- Included lock box attaches to bottom of cabinet (holds 8-10 locks)
- Cabinet dimensions: 16"H x 14"W x 6"D  
Lock box: 6"H x 15"W x 3"D
  - 1 - 120V Snap-On Breaker Lockouts (65387)
  - 1 - 120/277V Clamp-On Breaker Lockout w/cleats (65396)
  - 1 - 480/600V Clamp-On Breaker Lockout w/cleats (65397)
  - 1 - Universal Multi-Pole Breaker Lockout (66321)
  - 1 - Oversized Breaker Lockout (65329)
  - 1 - Wall Switch Lockout (65392)
  - 1 - 110V Electrical Plug Lockout (65674)
  - 1 - 3-in-1 Electrical Plug Lockout (PLO23)
  - 1 - 1" to 2-1/2" Gate Valve Lockout (65560)
  - 1 - 1" to 6-1/2" Adjustable Gate Valve Lockout (64057)
  - 6 - Keyed-different safety padlocks (99552) or steel padlocks (99500)
  - 6 - Heavy duty, re-usable lockout tags (65520) w/ nylon cable ties

Catalog #	Description
99709	Station w/ Components & 6 Safety Padlocks, 12 Tags
99710	Station w/ Components & 6 Steel Padlocks, 12 Tags
LC252M	Metal Lockout Cabinet (empty)
LG252M	Metal Wall Lock Box Only
LC254M	Extra Shelf



## Industrial Strength Lockout Station

- All metal, yellow powder-coated cabinet comes with one adjustable shelf (extra shelves available)
- Lockout safety tips on inside door
- Wall mounted or easily transported
- Cabinet dimensions: 16"H x 14"W x 6"D
- Components:
  - 3 - Red Safety padlocks (99552)
  - 3 - Yellow Safety padlocks (99570)
  - 1 - 2-1/2" to 5" Safetee™ Donut (SDO4)
  - 1 - 1" to 2-1/2" Safetee™ Donut (SDO2)
  - 1 - Single pole breaker lockout (BLO1)
  - 10 - Lockout tags with ties (LT10)
  - 2 - Multi pole breaker lockout (BLO3)
  - 1 - 1" Multiple lockout device (T218)
  - 1 - Single pole breaker lockout (BLO4)
  - 1 - 1-1/2" Multiple lockout device (T220)
  - 1 - 3-in-1 Electrical plug lockout (PLO23)
  - 1 - Small plug lockout (PLO21)

Catalog #	Description
LC251M	Industrial Strength Lockout Station
LC252M	Metal Lockout Cabinet (empty)
LC254M	Extra Shelf



Pictured Ready Access Valve & Electrical Lockout Station

## Ready Access Lockout Station

- Made of thermformed polypropylene for rugged durability
- Semi-transparent hinged cover with locking mechanism
- Slots in back for wall mounting as well as attachable carrying handle for portability
- 4 detachable hanging hooks inside compartment
- Storage compartment: 4.25"H x 16"W x 5.12"D  
Cabinet dimensions: 17" H x 17"W x 6.75"D

## Ready Access Valve Lockout Station

- 1 - Ready Access Lockout Station (105942)
- 2 - Adjustable Gate Valve Lockouts (64057)
- 1 - All Purpose Cable Lockout (50943)
- 2 - Ball Valve Lockouts (BS07A)
- 2 - 1" Group Lockout Hasps (65375)
- 1 - 1.5" Group Lockout Hasp (65376)
- Optional:
  - 6 - Keyed different safety padlocks (99552) or steel padlocks (99500)
  - 6 - Heavy duty, re-usable lockout tags (65520) w/ nylon cable ties

Catalog #	Description
105936	Valve Lockout Station Kit
105937	Kit w/ 6 Safety Padlocks & Tags
105938	Kit w/ 6 Steel Padlocks & Tags
105942	Ready Access Lockout Station (empty)

## Ready Access Electrical Lockout Station

- 1 - Ready Access Lockout Station (105942)
- 2 - 3-in-1 Electrical Plug Lockouts (PLO23)
- 1 - Mini Cable Lockout (50940)
- 2 - 120/277V Clamp-On Breaker Lockouts w/ cleats (65396)
- 2 - 480/600V Clamp-On Breaker Lockouts w/ cleats (65397)
- 2 - Universal Multipole Breaker Lockouts (66321)
- 1 - Oversized Breaker Lockout (65329)
- 2 - 1" Group Lockout Hasps (65375)
- 1 - 1.5" Group Lockout Hasps (65376)
- Optional:
  - 6 - Keyed different safety padlocks (99552) or steel padlocks (99500)
  - 6 - Heavy duty, re-usable lockout tags (65520) w/ nylon cable ties

Catalog #	Description
105939	Electrical Lockout Station Kit
105940	Kit w/ 6 Safety Padlocks & Tags
105941	Kit w/ 6 Steel Padlocks & Tags
105942	Ready Access Lockout Station (empty)

## Ready Access Valve & Electrical Lockout Station

- 1 - Ready Access Lockout Station (105942)
- 1 - Adjustable Gate Valve Lockout (64057)
- 1 - All Purpose Cable Lockout (50943)
- 1 - Ball Valve Lockout (BS07A)
- 1 - 3-in-1 Electrical Plug Lockout (PLO23)
- 2 - 120/277V Clamp-On Breaker Lockouts w/ cleats (65396)
- 1 - 480/600V Clamp-On Breaker Lockout w/ cleat (65397)
- 2 - Universal Multipole Breaker Lockouts (66321)
- 2 - 1" Group Lockout Hasps (65375)
- 1 - 1.5" Group Lockout Hasp (65376)
- Optional:
  - 6 - Keyed-different safety padlocks (99552) or steel padlocks (99500)
  - 6 - Heavy duty, re-usable lockout tags (65520) w/ nylon cable ties

Catalog #	Description
105933	Valve & Electrical Station Kit
105934	Kit w/ 6 Safety Padlocks & Tags
105935	Kit w/ 6 Steel Padlocks & Tags
105942	Ready Access Lockout Station (empty)

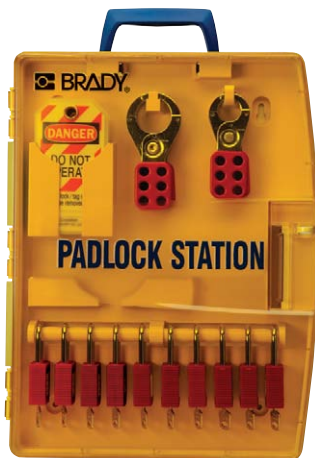

\*Pictured Ready Access Station with 10 Padlocks

## Ready Access Padlock Station

- Holds up to 10 padlocks, 6 hasps and 10 tags
- Made of thermformed polypropylene for rugged durability
- Semi-transparent hinged cover with locking mechanism
- Slots in back for wall mounting as well as attachable carrying handle for portability
- Space-saving design delivers footprint half the size of competitors
- Dimensions: 17"H x 13.25"W x 2.5"D

### Padlock Station w/5 Padlocks:

- 1 - Ready Access Padlock Station (105932)
- 5 - Keyed-different safety padlocks (99552) or steel padlocks (99500)
- 5 - Heavy Duty, re-usable lockout tags (65520) w/nylon cable tie
- 2 - 1" Group Lockout Hasps (65375)
- 2 - 1-1/2" Group Lockout Hasps (65376)

Catalog #	Description
105928	Station w/ 5 Safety Padlocks
105929	Station w/ 5 Steel Padlocks
105932	Ready Access Padlock Station (empty)

### Padlock Station w/10 Padlocks:

- 1 - ReadyAccess Padlock Station (105932)
- 10 - Keyed-different safety padlocks (99552) or steel padlocks (99500)
- 10 - Heavy duty, re-usable lockout tags (65520) w/ nylon cable ties
- 3 - 1" Group Lockout Hasps (65375)
- 3 - 1-1/2" Group Lockout Hasps (65376)

Catalog #	Description
105930	Station w/ 10 Safety Padlocks
105931	Station w/ 10 Steel Padlocks
105932	Ready Access Padlock Station (empty)



# Lockout Stations

BradyID.com/lockouttagout

## LOCKOUT STATION



Shown without optional lockable clear acrylic door

### Extra-Large Lockout Station

- Provides everything you need to lockout most mechanical and electrical control points
- Constructed of sturdy polystyrene with predrilled holes for easy wall mounting
- Pegboard-style holes for hooks drilled into back and sides (includes 8 hooks)
- Built-in lock rail holds 20-25 locks
- Dimensions: 30"H x 25"W x 5-1/4"D
- Available with or without lockable door
- Components:
  - 1 - All Purpose Cable Lockout w/ 8' Sheathed Cable (50943)
  - 1 - Large Univ. Valve Lockout w/Blocking Arm (50899 and 65403)
  - 2 - 120V Snap-On Breaker Lockouts (65387)
  - 2 - 120/277V Clamp-On Breaker Lockouts (65396)
  - 2 - 480/600V Clamp-On Breaker Lockouts (65397)
  - 2 - Universal Multi-Pole Breaker Lockouts (66321)
  - 1 - Oversized Breaker Lockout (65329)
  - 2 - Cleats for 120/277V Clamp-On Lockouts (65404)
  - 2 - Cleats for 480/600V Clamp-On Lockouts (65406)
  - 1 - Wall Switch Lockout (65392)
  - 1 - 110V Electrical Plug Lockout (65674)
  - 1 - 3-in-1 Electrical Plug Lockout (PLO23)
  - 1 - 1/4" to 1" Ball Valve Lockout (65666)
  - 1 - 1-1/4" to 3" Ball Valve Lockout (65669)
  - 2 - 1" to 2-1/2" Gate Valve Lockouts (65560)
  - 1 - 1" to 6-1/2" Adjustable Gate Valve Lockout (64057)
  - 2 - Labeled Lockout Hasps (65960)
  - 18 - Keyed different safety padlocks (99552) or steel padlocks (99500)
  - 25 - Heavy duty, re-usable lockout tags (65520) w/ nylon cable ties
  - 1 Station with "Lockout Station" legend

Catalog #	Description
<b>Open Style Without Doors</b>	
99693	Station w/ Components and 18 Safety Padlocks, 25 Tags
99694	Station w/ Components and 18 Steel Padlocks, 25 Tags
50993	Extra-Large Lockout Station (empty)
<b>Enclosed Style With Lockable Doors</b>	
99696	Station w/ Components and 18 Safety Padlocks, 25 Tags
99700	Station w/ Components and 18 Steel Padlocks, 25 Tags
50995	Extra-Large Enclosed Lockout Station (empty)

## LOCKOUT STATION



Shown with optional lockable clear acrylic door

### Large Lockout Station

- Provides everything you need to lock out most types of electrical control points
- Constructed of sturdy polystyrene with predrilled holes for easy wall mounting
- Pegboard-style holes for hooks drilled into back (includes 6 hooks)
- Built-in lock rail holds 15-20 locks
- Dimensions: 26"H x 19-1/2"W x 5"D
- Available with or without lockable door
- Components:
  - 1 - All Purpose Cable Lockout w/ 8' Sheathed Cable (50943)
  - 1 - Large Univ. Valve Lockout w/Blocking Arm (50899 and 65403)
  - 1 - 110V Electrical Plug Lockout (65674)
  - 1 - 3-in-1 Electrical Plug Lockout (PLO23)
  - 1 - 1/4" to 1" Ball Valve Lockout (65666)
  - 1 - 1" to 2-1/2" Gate Valve Lockout (65560)
  - 1 - 1" to 6-1/2" Adj. Gate Valve Lockout (64057)
  - 2 - Labeled Lockout Hasps (65960)
  - 12 - Keyed different safety padlocks (99552) or steel padlocks (99500)
  - 25 - Heavy duty, re-usable lockout tags w/ nylon cable ties. Tag legend options:
    - Danger Do Not Operate (65520)
    - Precaucion No Hacer Funcionar (121518)
    - Peligro No Operar (98219)
  - 1 Station with "Lockout Station" or "Estacion de Bloqueo" legend

Catalog #	Description
<b>Open Style Without Doors</b>	
99699	English Station w/ Components and 12 Safety Padlocks, 25 "Danger Do Not Operate" Tags
121508	Spanish Station w/ Components and 12 Safety Padlocks, 25 "Precaucion No Hacer Funcionar" Tags
121512	Spanish Station w/ Components and 12 Safety Padlocks, 25 "Peligro No Operar" Tags
99697	English Station w/ Components and 12 Steel Padlocks, 25 "Danger Do Not Operate" Tags
50994	English Open Style Station (empty)
121509	Spanish Open Style Station (empty)
<b>Enclosed Style With Lockable Doors</b>	
99703	English Enclosed Station w/ Components and 12 Safety Padlocks, 25 "Danger Do Not Operate" Tags
99704	English Enclosed Station w/ Components and 12 Steel Padlocks, 25 "Danger Do Not Operate" Tags
50996	English Enclosed Station (empty)

## LOCKOUT STATION



### Small Lockout Station

- Provides everything you need to lockout most types of electrical control points
- Constructed of sturdy polystyrene with predrilled holes for easy wall mounting
- Pegboard-style holes for hooks drilled into back (includes 4 hooks)
- Built-in lock rail holds 10-15 locks
- Dimensions: 18"H x 12"W x 4"D
- Components:
  - 1 - Mini Cable Lockout (50940)
  - 2 - 120V Snap-On Breaker Lockouts (65387)
  - 2 - 120/277V Clamp-On Breaker Lockouts w/ cleats (65396)
  - 2 - 480/600V Clamp-On Breaker Lockouts w/ cleats (65397)
  - 2 - Universal Multi-Pole Breaker Lockouts (66321)
  - 1 - Oversized Breaker Lockout (65329)
  - 1 - Wall Switch Lockout (65392)
  - 1 - 110V Electrical Plug Lockout (65674)
  - 1 - 3-in-1 Electrical Plug Lockout (PLO23)
  - 1 - Small fuse blockout (65690)
  - 1 - Large fuse blockout (65691)
  - 2 - Labeled Lockout Hasps (65960)
  - 6 - Keyed different safety padlocks (99552) or steel padlocks (99500)
  - 12 - Heavy duty, re-usable lockout tags (65520) w/ nylon cable ties
  - 1 Station with "Lockout Station" legend

Catalog #	Description
99706	Station w/ Components & 6 Safety Padlocks, 12 Tags
99707	Station w/ Components & 6 Steel Padlocks, 12 Tags
50997	Small Lockout Station (empty)



## Prinzing Starter Lockout Station

- Heavy duty lockout cabinet with the essential items needed to keep your facility safe and locked out
- Components:
  - 1 - Ball Valve Lockout (BS07A)
  - 2 - 2.5" to 5" Gate Valve Lockout (65561)
  - 2 - 3-in-1 Electrical Plug Lockout (PLO23)
  - 6 - 1-1/2" Steel Lockout Hasp (T220)
  - 50 - 7" Red Cable Ties (FT100X-RED)
  - 25 - Lockout Tags (TG027E)
  - 3 - Red Brady Safety Padlocks, Key-Different (99552)
  - 3 - Yellow Brady Safety Padlocks, Key-Different (99570)
  - 1 - Lockout Tagout Cabinet Station (LC977A)

Catalog #	Description
LC517E	Prinzing Starter Lockout Station



## Prinzing Valve & Electrical Lockout Station

- Heavy duty lockout cabinet station contains many common valve and electrical lockout devices needed in a facility
- Components:
  - 1 - Ball Valve Lockout (BS07A)
  - 3 - No-hole Breaker Lockout (BL04)
  - 3 - Breaker Lockout, Multi-pole (BL07)
  - 6 - 1-1/2" Steel Lockout Hasp (T220)
  - 2 - 3-in-1 Electrical Plug Lockout (PLO23)
  - 3 - Wall Switch Lockout (WSLO)
  - 2 - 2.5" to 5" Gate Valve Lockout (65561)
  - 50 - 7" Red Cable Ties (FT100X-RED)
  - 1 - OSHA Lockout Summary Sheet
  - 1 - Lockout miniposter (PS811B)
  - 25 - Lockout Tags (TG027E)
  - 1 - Lockout Tagout Cabinet Station (LC977A)

Catalog #	Description
LC518E	Prinzing Valve & Electrical Lockout Station



## Lockout Tagout Station

- Fully equipped lockout tagout station to store all of your facility devices
- Components:
  - 1 - 1/2" to 2-1/2" Ball Valve Lockout (BS07A)
  - 2 - 2.3" to 5" Gate Valve Lockouts (65561)
  - 2 - 120/277V Clamp-On Breaker Lockout w/ cleats (65396)
  - 3 - Universal Multi-Pole Breaker Lockouts (66321)
  - 2 - 3-in-1 Electrical Plug Lockouts (PLO23)
  - 2 - Wall Switch Lockouts (65392)
  - 6 - 1-1/2" Steel Lockout Hasps (T220)
  - 1 - OSHA Lockout Tagout Summary Sheet
  - 100 - Red Cable Ties (FT100)
  - 25 - Lockout Danger Tags (TG027E)
  - 3 - Brady Safety Padlocks, Yellow, Keyed Different (99570)
  - 3 - Brady Safety Padlocks, Red, Keyed Different (99552)
  - 1 - Lockout Cabinet (LC584E)

Catalog #	Description
134036	Lockout Tagout Station



## Safety Lockout Center

- Provides ready access to locks, tags, lockout devices and information
- Made of tough acrylic plastic
- Station size: 30"H x 24"W x 4-1/2"D
- Components:
  - 6 - Multi-color steel padlocks
  - 2 - 10 pack English lockout tags with ties (LT10)
  - 5 - 1-1/2" lockout hasps (T220)
  - 25 - English Lockout Safety booklets (2112X)

Catalog #	Description
3001	Safety Lockout Center
3012	Board Only



## Bilingual Safety Lockout Center

- Provides ready access to locks, tags, lockout devices and information
- Made of tough acrylic plastic
- Station size: 30"H x 24"W x 4-1/2"D
- Components:
  - 6 - Multi-color padlocks
  - 2 - 10 pack Bilingual lockout tags with ties (TG400B-10)
  - 5 - 1-1/2" lockout hasps (T220)
  - 15 - English Lockout Safety booklets (2112X)
  - 10 - Spanish Lockout Safety booklets (2112SPX)

Catalog #	Description
3002	Bilingual Safety Lockout Center
3013	Bilingual Board Only

## May We Also Suggest:

### Lockout Station V-Sign

- Enhance the visibility of your Lockout Station with this V-shaped polyethylene sign
- Sign size: 8" x 9" x 1" flange (overall width is 14")



Catalog #	Description
66328	Lockout Stations V-Sign

# Lockout Stations

BradyID.com/lockouttagout



## Prinzing Lockout Center

- Large, easily identifiable lockout station to hold all of the necessary lockout items for your facility
- Components:
  - 2 - 1-1/2" Steel Lockout Hasp (T220)
  - 1 - 2.5" to 5" Gate Valve Lockout (65561)
  - 1 - 3-in-1 Electrical Plug Lockout (PLO23)
  - 1 - Small Plug Lockout (PLO21)
  - 1 - 1/2" to 2-1/2" Small Ball Valve Lockout (BS07A)
  - 2 - 4"x6" Magnetic Danger Sign
  - 1 - Pad of Lockout Tagout checklists (119076)
  - 1 - Lockout miniposter (PS811B)
  - 10 - Lockout Danger Tags
  - 2 - Aluminum Padlocks, 1.5" Shackle, Keyed Different, Red (99615)
  - 2 - Aluminum Padlocks, 1.5" Shackle, Keyed Different, Blue (99616)
  - 2 - Aluminum Padlocks, 1.5" Shackle, Keyed Different, Yellow (99618)
  - 2 - Aluminum Padlocks, 1.5" Shackle, Keyed Different, Green (99617)
  - 1 - Large Yellow Lockout Board (LC501E)

Catalog #	Description
LC502E	Prinzing Lockout Center
LC501E	Prinzing Lockout Board Only



## Prinzing Micro Lockout Station

- Compact and convenient mini-lockout station for essential items
- Components:
  - 5 - 7" Red Cable Ties (FT100X-RED)
  - 1 - 1-1/2" Steel Lockout Hasp (T220)
  - 2 - Lockout Tags (LT1)
  - 1 - 3/4" Red Key-Retaining Steel Padlock (143126)
  - 1 - Micro Lockout Board (LC226A)

Catalog #	Description
KT226A	Prinzing Micro Lockout Station
LC226A	Board Only



## Prinzing Lockout Board

- Unfilled, wall mounted Lockout Center holds many of your most common devices needed around the facility for easy access and storage

Catalog #	Description
LC744E	Prinzing Lockout Board



## 5-Lock Board

- Dimensions: 11-1/2"H x 15-1/2"W
- Components:
  - 5 - Keyed different safety padlocks (99552) or steel padlocks (99500)
  - 1 - 1" metal hasp (65375)
  - 1 - 1-1/2" metal hasp (65376)
  - 12 - heavy duty tags (65520)

Catalog #	Description
51181	5-Lock Board & 5 Safety Padlocks
51186	5-Lock Board & 5 Steel Padlocks
50989	5-Lock Board (Board Only)



## Prinzing Economy Lockout Center

- Dimensions: 9" H x 12" W
- Components:
  - 10 - Lockout Tags (LT10)
  - 1 - 1.5" Lockout Hasp (T220)
  - 4 - Key Retaining Steel Locks, 3/4" Shackle Blue (143130)
  - 1 - Lockout Tagout Center (LC202G)

Catalog #	Description
LC203G	Prinzing Lockout Station
LC202G	Prinzing Lockout Board Only



### Did you know? Lock Boards

- Lock boards contribute to a successful lockout program by providing storage at the point of need for all of your devices
- Boards are made of 3/16" thick bright yellow acrylic with acrylic lock rails.
- Tag pockets are made of clear polycarbonate and will hold tags up to 3" wide.







## Prinzing Economy Lockout Center

- Dimensions: 14" H x 14" W
- Components:
  - 10 - Lockout Tags (LT10)
  - 1 - 1" Lockout Hasp (T218)
  - 1 - 1.5" Lockout Hasp (T220)
  - 2 - 1-1/2" Hasps
  - 24 - Heavy Duty Tags
  - 6 - Key Retaining Steel Locks, 3/4" shackle (Green, Yellow, Black, White, Blue, Red)
  - 1 - Lockout Tagout Center (3004Y)

Catalog #	Description
3003Y	Prinzing Economy Lockout Center
3004Y	Lockout Board Only



## Prinzing Bilingual Lockout Center

- Dimensions: 14" H x 14" W
- Components:
  - 10 - Bilingual Lockout Tags (TG400B-ONE)
  - 1 - 1" Lockout Hasp (T218)
  - 1 - 1.5" Lockout Hasp (T220)
  - 6 - Key Retaining Steel Locks, 3/4" shackle (Green, Yellow, Black, White, Blue, Red)
  - 1 - Bilingual Lockout Tagout Center (LC210G)

Catalog #	Description
LC211G	Prinzing Bilingual Lockout Center
LC210G	Prinzing Bilingual Lockout Board Only



## 10-Lock Board

- Dimensions: 13-1/2"H x 13-1/2"W
- Components:
  - 10 - Keyed different safety padlocks (99552) or steel padlocks (99500)
  - 2 - 1" hasps (65375)
  - 2 - 1-1/2" hasps (65376)
  - 12 - Heavy duty tags (65520)

Catalog #	Description
51187	10-Lock Board & 10 Safety Padlocks
51188	10-Lock Board & 10 Steel Padlocks
50990	10-Lock Board (Board Only)



## 20-Lock Board

- Dimensions: 23-1/2"H x 11-1/2"W
- Components:
  - 20 - Keyed different safety padlocks (99552) or steel padlocks (99500)
  - 2 - 1" hasps (65375)
  - 2 - 1-1/2" hasps (65376)
  - 24 - Heavy duty tags. Tag legend options:
    - Danger Do Not Operate (65520)
    - Peligro No Operar (98219)
    - Precaucion No Hacer Funcionar (121518)

Catalog #	Description
51189	20-Lock Board w/ 20 Safety Padlocks "Lockout Station" Board "Danger Do Not Operate" Tags
51194	20-Lock Board & 20 Steel Padlocks "Lockout Station" Board "Danger Do Not Operate" Tags
121507	20-Lock Board w/ 20 Safety Padlocks "Estacion de Bloqueo" Board "Precaucion No Hacer Funcionar" Tags
121511	20-Lock Board w/ 20 Safety Padlocks "Estacion de Bloqueo" Board "Peligro No Operar" Tags
50991	20-Lock "Lockout Station" Board Only
121506	20-Lock "Estacion de Bloqueo" Board Only



## 36-Lock Board

- Dimensions: 21-1/2"H x 23-1/2"W
- Components:
  - 36 - Keyed different safety padlocks (99552) or steel padlocks (99500)
  - 3 - 1" hasps (65375)
  - 3 - 1-1/2" hasps (65376)
  - 36 - Heavy duty tags (65520)

Catalog #	Description
51195	36-Lock Board & 36 Safety Padlocks
51196	36-Lock Board & 36 Steel Padlocks
50992	36-Lock Board (Board Only)

**! May We Also Suggest:**

### Ready Access Padlock Station

- Wall mountable, thermformed polypropylene cabinet with semi-transparent lockable door
- Holds up to 10 padlocks, 6 hasps and 10 tags

*See page 453 for more information.*



# Energy Source Tags

BradyID.com/lockouttagout



## Energy Source Tags

Energy source tags can be used to mark your facility's points of control for energy sources. These tags help make the lockout process quicker, safer and easier.

These energy source tags are made of plastic and available with color coded and alpha numeric options. A variety of pre-printed energy source tags are available or they can be customized to meet your specific application.

- 1.5" x 3" tags are constructed with B-401 Rigid Plastic
- Rounded corners and one hole included

## Energy Source Tag Guide

Brady offers a number of options based on your needs. Use the guide below to ensure that you are selecting the appropriate tag based on your application.

Abbr.	Color	Energy Source	Number of Energy Points*
CP	Orange on White	Control Panel	1 thru 9
E	Red on White	Electrical	1 thru 9
G	Purple on White	Gas	1 thru 9
V	Black on White	Valve	1 thru 9
W	White on Green	Water	1 thru 9
S	White on Red	Steam	1 thru 9
S	Black on Orange	Steam	1 thru 9
P	White on Blue	Pneumatic / Air	1 thru 9

\* Choice of numbers supports machines with multiple energy points.

**Custom Tags Also Available.**  
Contact Brady to find out more.



### Control Panel

Catalog #	Legend	Picto	Color	Qty.
105634	CP-1	-	Orange on White	5
105674	CP-1	-	Orange on White	25
105635	CP-2	-	Orange on White	5
105675	CP-2	-	Orange on White	25
105636	CP-3	-	Orange on White	5
105676	CP-3	-	Orange on White	25
105637	CP-4	-	Orange on White	5
105677	CP-4	-	Orange on White	25
105638	CP-5	-	Orange on White	5
105673	CP-5	-	Orange on White	25

\* Control Panel tags supplied with an adhesive back.



### Electrical

Catalog #	Legend	Picto	Color	Qty.
105639	E-1	Electric Bolt	Red on White	5
105679	E-1	Electric Bolt	Red on White	25
105640	E-2	Electric Bolt	Red on White	5
105680	E-2	Electric Bolt	Red on White	25
105641	E-3	Electric Bolt	Red on White	5
105681	E-3	Electric Bolt	Red on White	25
105642	E-4	Electric Bolt	Red on White	5
105682	E-4	Electric Bolt	Red on White	25
105643	E-5	Electric Bolt	Red on White	5
105683	E-5	Electric Bolt	Red on White	25

\* Electrical tags supplied with an adhesive back.

# Energy Source Tags

BradyID.com/lockouttagout



## Water

Catalog #	Legend	Picto	Color	Qty.
105644	W-1	Spout	White on Green	5
105684	W-1	Spout	White on Green	25
105645	W-2	Spout	White on Green	5
105685	W-2	Spout	White on Green	25
105646	W-3	Spout	White on Green	5
105686	W-3	Spout	White on Green	25
105647	W-4	Spout	White on Green	5
105687	W-4	Spout	White on Green	25
105648	W-5	Spout	White on Green	5
105688	W-5	Spout	White on Green	25

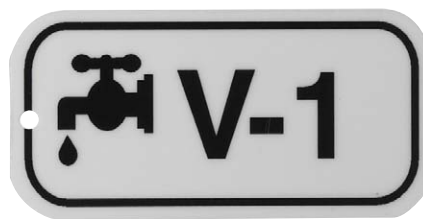

## Valve

Catalog #	Legend	Picto	Color	Qty.
105664	V-1	Spout	Black on White	5
105704	V-1	Spout	Black on White	25
105665	V-2	Spout	Black on White	5
105705	V-2	Spout	Black on White	25
105666	V-3	Spout	Black on White	5
105706	V-3	Spout	Black on White	25
105667	V-4	Spout	Black on White	5
105707	V-4	Spout	Black on White	25
105668	V-5	Spout	Black on White	5
105708	V-5	Spout	Black on White	25



## Steam

Catalog #	Legend	Picto	Color	Qty.
105649	S-1	Single Pressure Steam Gauge	White on Red	5
105689	S-1	Single Pressure Steam Gauge	White on Red	25
105650	S-2	Single Pressure Steam Gauge	White on Red	5
105690	S-2	Single Pressure Steam Gauge	White on Red	25
105651	S-3	Single Pressure Steam Gauge	White on Red	5
105691	S-3	Single Pressure Steam Gauge	White on Red	25
105652	S-4	Single Pressure Steam Gauge	White on Red	5
105692	S-4	Single Pressure Steam Gauge	White on Red	25
105653	S-5	Single Pressure Steam Gauge	White on Red	5
105693	S-5	Single Pressure Steam Gauge	White on Red	25



## Steam

Catalog #	Legend	Picto	Color	Qty.
105659	S-1	Single Pressure Steam Gauge	Black on Orange	5
105699	S-1	Single Pressure Steam Gauge	Black on Orange	25
105660	S-2	Single Pressure Steam Gauge	Black on Orange	5
105670	S-2	Single Pressure Steam Gauge	Black on Orange	25
105661	S-3	Single Pressure Steam Gauge	Black on Orange	5
105671	S-3	Single Pressure Steam Gauge	Black on Orange	25
105662	S-4	Single Pressure Steam Gauge	Black on Orange	5
105672	S-4	Single Pressure Steam Gauge	Black on Orange	25
105663	S-5	Single Pressure Steam Gauge	Black on Orange	5
105673	S-5	Single Pressure Steam Gauge	Black on Orange	25



## Pneumatic / Air

Catalog #	Legend	Picto	Color	Qty.
105654	P-1	Double Pressure Air Gauge	White on Blue	5
105694	P-1	Double Pressure Air Gauge	White on Blue	25
105655	P-2	Double Pressure Air Gauge	White on Blue	5
105695	P-2	Double Pressure Air Gauge	White on Blue	25
105656	P-3	Double Pressure Air Gauge	White on Blue	5
105696	P-3	Double Pressure Air Gauge	White on Blue	25
105657	P-4	Double Pressure Air Gauge	White on Blue	5
105697	P-4	Double Pressure Air Gauge	White on Blue	25
105658	P-5	Double Pressure Air Gauge	White on Blue	5
105698	P-5	Double Pressure Air Gauge	White on Blue	25



## Gas

Catalog #	Legend	Picto	Color	Qty.
105669	G-1	Double Pressure Gas Gauge	Purple on White	5
105709	G-1	Double Pressure Gas Gauge	Purple on White	25
105670	G-2	Double Pressure Gas Gauge	Purple on White	5
105710	G-2	Double Pressure Gas Gauge	Purple on White	25
105671	G-3	Double Pressure Gas Gauge	Purple on White	5
105711	G-3	Double Pressure Gas Gauge	Purple on White	25
105672	G-4	Double Pressure Gas Gauge	Purple on White	5
105712	G-4	Double Pressure Gas Gauge	Purple on White	25
105673	G-5	Double Pressure Gas Gauge	Purple on White	5
105713	G-5	Double Pressure Gas Gauge	Purple on White	25

Lockout Tagout



# Lockout Tags

BradyID.com/lockouttagout

## OSHA Lockout Tagout Regulations

The following requirements apply only to tags used as tagout devices (i.e., tags used alone without locks). Tags used in combination with locks are not required to meet the same restrictions as tagout devices.

Tagout devices must:

- Be provided by the employer
- Be standardized by size, shape or color
- Be distinguishable from tags used for other purposes
- Be understandable to all employees
- Identify the individual who applied the tag
- Withstand the usage environment to which they are exposed for the maximum period of time that exposure is intended. Tag should not deteriorate or the message become illegible when exposed to weather, wet or damp conditions, chemical or corrosive environments.
- Employ a means of attachment that is substantial enough to prevent accidental removal. The means of attachment must be of a non-reusable type, attachable by hand, self-locking, and non-releasable with a minimum unlocking strength of no less than 50 pounds.
- Warn against hazardous conditions if the machine or equipment is energized.
- Tag shall also include a legend such as the following: Do Not Operate, Do Not Start, Do Not Open, Do Not Close, etc.



## Standard Lockout Tags

Communicate safety and lockout information at the point of need with Brady's wide selection of OSHA-compliant Lockout Tagout tags. Brady's Lockout Tags come in a variety of materials and legends to suit your application needs.

### How to Order Tags

1. Select from the materials below based on your application
2. Choose the tag legend for your tag
3. Order by part number for desired reverse side legend

## Available Tag Materials:



### Heavy Duty Polyester (B-837)

- Durable polyester laminate completely encapsulates and protects graphics
- Designed to withstand moisture, grease, chemicals and extreme temperatures
- Accepts pencil, pen and marker. Pen and marker can be completely erased using isopropyl alcohol
- Exceeds OSHA pull requirement withstanding up to 80 lbs of pull force
- 3/8" dia. heavy-duty brass grommet
- Includes OSHA-compliant nylon fasteners



### Economy Polyester (B-851)

- Rigid polyester surface is easy to write on and stays legible longer than cardstock
- Exceeds OSHA 50 lb. pull requirement for tagout devices
- 3/8" dia. rolled brass eyelet accepts most padlock shackles
- Includes OSHA-compliant nylon fasteners



### Cardstock (B-853)

- Cost-effective tags designed for one-time use
- Does NOT meet OSHA 50 lb. pull test for tagout devices, but can be used in conjunction with locks (see OSHA Tag Requirements above)
- 3/8" dia. rolled brass eyelet accepts most padlock shackles
- Includes attachment strings

# Lockout Tags

BradyID.com/lockouttagout

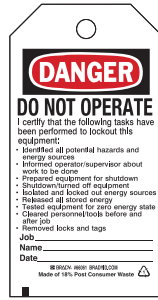

Catalog #	Reverse Legend	Qty.
<b>Heavy Duty Polyester 5-1/2" x 3"</b>		
65502	Side B	25
65535	Side F	25
65670	Side G	25
<b>Economy Polyester 5-3/4" x 3"</b>		
66050	Side B	25
66051	Side F	25
66052	Side G	25
<b>Cardstock 5-3/4" x 3"</b>		
65407	Side B	25
65408	Side F	25
65440	Side G	25

Catalog #	Reverse Legend	Qty.
<b>Heavy Duty Polyester 5-1/2" x 3"</b>		
65520	Side B	25
65525	Side F	25
65671	Side G	25
<b>Economy Polyester 5-3/4" x 3"</b>		
66063	Side B	25
66064	Side F	25
66065	Side G	25
<b>Cardstock 5-3/4" x 3"</b>		
65451	Side B	25
65452	Side F	25
65453	Side G	25

Catalog #	Reverse Legend	Qty.
<b>Heavy Duty Polyester 5-1/2" x 3"</b>		
65515	Side B	25
65524	Side F	25
133489	Side G	25
<b>Economy Polyester 5-3/4" x 3"</b>		
66061	Side B	25
66062	Side F	25
133490	Side G	25
<b>Cardstock 5-3/4" x 3"</b>		
133491	Side B	25
65450	Side F	25
133492	Side G	25

Catalog #	Reverse Legend	Qty.
<b>Heavy Duty Polyester 5-1/2" x 3"</b>		
65526	Side B	25
65527	Side F	25
133493	Side G	25
<b>Economy Polyester 5-3/4" x 3"</b>		
66066	Side B	25
66067	Side F	25
133494	Side G	25
<b>Cardstock 5-3/4" x 3"</b>		
65454	Side B	25
65455	Side F	25
133495	Side G	25

Catalog #	Reverse Legend	Qty.
<b>Heavy Duty Polyester 5-1/2" x 3"</b>		
65505	Side B	25
65523	Side F	25
133496	Side G	25
<b>Economy Polyester 5-3/4" x 3"</b>		
133497	Side B	25
133498	Side F	25
133499	Side G	25
<b>Cardstock 5-3/4" x 3"</b>		
65445	Side B	25
65446	Side F	25
133544	Side G	25

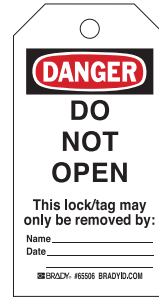

Catalog #	Reverse Legend	Qty.
<b>Heavy Duty Polyester 5-1/2" x 3"</b>		
65503	Side B	25
65521	Side F	25
133545	Side G	25
<b>Economy Polyester 5-3/4" x 3"</b>		
66053	Side B	25
66054	Side F	25
133546	Side G	25
<b>Cardstock 5-3/4" x 3"</b>		
65441	Side B	25
65442	Side F	25
133547	Side G	25

Catalog #	Reverse Legend	Qty.
<b>Heavy Duty Polyester 5-1/2" x 3"</b>		
65504	Side B	25
65522	Side F	25
133548	Side G	25
<b>Economy Polyester 5-3/4" x 3"</b>		
66055	Side B	25
66056	Side F	25
133549	Side G	25
<b>Cardstock 5-3/4" x 3"</b>		
65443	Side B	25
65444	Side F	25
133550	Side G	25

Catalog #	Reverse Legend	Qty.
<b>Heavy Duty Polyester 5-1/2" x 3"</b>		
133551	Side B	25
133552	Side F	25
133553	Side G	25
<b>Economy Polyester 5-3/4" x 3"</b>		
50198	Side B	25
50199	Side F	25
133554	Side G	25
<b>Cardstock 5-3/4" x 3"</b>		
133555	Side B	25
50250	Side F	25
133556	Side G	25

Catalog #	Reverse Legend	Qty.
<b>Heavy Duty Polyester 5-1/2" x 3"</b>		
65506	Side B	25
65534	Side F	25
133557	Side G	25
<b>Economy Polyester 5-3/4" x 3"</b>		
133558	Side B	25
66060	Side F	25
133559	Side G	25
<b>Cardstock 5-3/4" x 3"</b>		
65447	Side B	25
65448	Side F	25
133560	Side G	25

Catalog #	Reverse Legend	Qty.
<b>Heavy Duty Polyester 5-1/2" x 3"</b>		
133561	Side B	25
50258	Side F	25
133562	Side G	25
<b>Economy Polyester 5-3/4" x 3"</b>		
133563	Side B	25
133564	Side F	25
133565	Side G	25
<b>Cardstock 5-3/4" x 3"</b>		
50261	Side B	25
133566	Side F	25
133567	Side G	25

Can't find what you're looking for?

Call Brady Customer Service to find out more about custom solutions.

## Reverse Legend Options

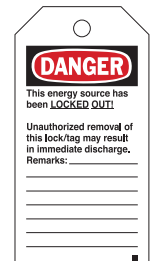

Reverse Side B

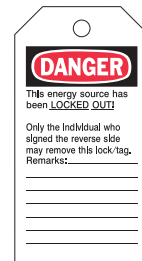

Reverse Side F



Reverse Side G

# Lockout Tags

BradyID.com/lockouttagout

Lockout Tagout



## Spanish Lockout Tags

- B-837 - Heavy Duty Laminated Polyester tags meet OSHA's 50 lb. pull force requirement for Tagout and have superior chemical resistance. These plastic tags are encapsulated in matte polyester laminate for superior durability. Nylon ties included.
  - B-851 - Economy Polyester tags meet OSHA's 50 lb. pull force requirement for Tagout and have moderate chemical resistance. Nylon ties included.
- \* Designates tags that have a self-adhesive, clear overlaminat flap which is pressed over the face of the tag for permanent protection.*
- † Designates tags that have a larger hole without a grommet to accommodate padlocks.*
- B-853 - Cardstock tags provide an economical, yet durable material option. Attachment strings included.



98219 3"x5-3/4" B-851 10/pk



121514 3"x5-3/4" B-851\* 10/pk



121515 5-1/5" x 3" B-837 25/pk  
121516 5-3/4" x 3" B-851 25/pk  
121517 5-3/4" x 3" B-853 25/pk



121518 5-1/5" x 3" B-837 25/pk  
121519 5-3/4" x 3" B-851 25/pk  
121520 5-3/4" x 3" B-853 25/pk



Front

Back

## Self-Laminating Photo Tags

- Include employee photos for easy identification and greater impact
- Constructed of durable B-851 polyester
- Available with or without 1 mil polyester overlay on front
- Includes nylon fasteners

Catalog #	Description	Size	Qty.
65500	w/o Laminate	5-3/4" x 3"	10
65501	w/ Laminate	5-3/4" x 3"	10
96222	w/ Laminate	7" x 4"	10



## Tags w/ Detachable Key Stub

- Perforated heavy cardstock tag with detachable key stub
- Matching identification numbers printed on each part
- Accepts pencil, pen or marker
- Tie strings provided for easy tag attachment
- 1"-diameter metal ring provided for attaching stub to key

Catalog #	Legend	Size	Qty.
WKT2	Equipment Locked Out	5-3/4" x 3"	25
WKT3	Do Not Operate	5-3/4" x 3"	25



## Padlock Tags

- Calendered vinyl accepts pencil, pen or marker
- Employs 3/8" metal grommet that fits over most padlock shackles
- Dimensions: 3" x 2" (grommet adds another 1" to height)
- Sold individually

Catalog #	Legend	Size	Qty.
105722	Equipment Locked Out	3" x 2" plus grommet	1
105723	Do Not Operate	3" x 2" plus grommet	1
105724	Do Not Operate English/Spanish	3" x 2" plus grommet	1

## Two-Part Perforated Tags

Two-part tags provide enhanced operational control and record-keeping. Stub is removed when tag is attached to a lockout point. Only the employee in possession of the stub has the authority to remove the tag. After the job is done, stub is returned to management for verification and monitoring of Lockout Tagout activity in the plant. Matching identification numbers are printed on each part.

- B-851 - Economy Polyester tags are durable 10 mil-thick polyester making it easy to remove chemicals, grease and grime. Suitable for indoor or outdoor use. Nylon ties included.
- B-853 - Cardstock tags provide an economical, yet durable material option. Attachment strings included.

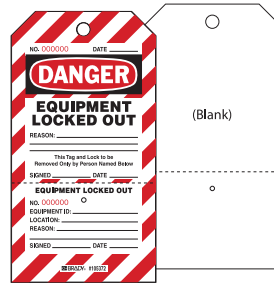

PLLT2 7-1/2" x 4" B-851 25/pk  
CLT2 7-1/2" x 4" B-853 25/pk

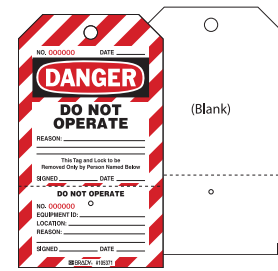

PLLT4 7-1/2" x 4" B-851 25/pk  
CLT4 7-1/2" x 4" B-853 25/pk



## 1-Pocket Tag Holder

- Clear plastic holder is designed to hold 50 tags, ties and a marking pen (Tags and pen not included)
- Comes with adhesive strips, magnetic strips, and screws for mounting
- Dimensions: 7-1/2"H x 4-1/2"W x 1-1/2"D

Catalog #	Description
TH2	1-Pocket Economy Tag Holder

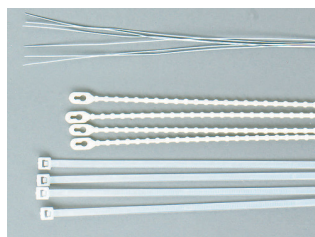

## Tag Fasteners

- Three fastener styles available to meet every application
- Nylon fasteners meet OSHA requirements for attaching tagout devices

Catalog #	Description	Qty.
81760	12" 26 Gauge Wire	100
81761	8" Reusable Beaded Ties	100
81762	8" Nylon Fasteners	100



## Pocket Premium Tag Center

- Acrylic center features 8 pockets for displaying and dispensing tags
- Each pocket holds up to 30 tags. Tags not included
- Four pre-drilled holes for wall mounting
- Dimensions: 15-3/4"H x 23-1/2"W x 2"D

Catalog #	Description
TC8	8-Pocket Premium Tag Center



## Magnetic-Backed Protective Envelopes

- Transparent, durable vinyl construction makes it ideal for indoor or outdoor use
- Protects tags and data cards on machinery, valves, switches and more

Catalog #	Size	Qty.
81769	4-1/2" x 6-1/2"	10
81770	5-1/2" x 8-1/2"	10



## 10-Pocket Tag Safety Station

- Made of rugged polycarbonate
- Four pre-drilled holes for wall mounting
- Dimensions: 22"H x 16-1/2"W x 2-1/4"D
- Tags not included

Catalog #	Description
81773	10-Pocket Tag Safety Station



## Zip-Lock Protective Envelopes

- Transparent, durable vinyl construction makes it ideal for indoor or outdoor use
- Protects tags and data cards on machinery, valves, switches and more

Catalog #	Size	Qty.
81765	4-1/2" x 6-1/2" (w/o grommet)	10
81766	4-1/2" x 6-1/2" (w/grommet)	10
81767	5-1/2" x 8-1/2" (w/o grommet)	10
81768	5-1/2" x 8-1/2" (w/grommet)	10



# Padlocks

BradyID.com/lockouttagout



## Padlocks

A written plan and comprehensive training program are foundational to a successful lockout tagout program. However, having the right tools for the job is extremely important, no matter what your industry is.

Although padlocks may seem like a commonplace device, the durability and reliability of your padlocks is critical to your facility's safety. Brady provides a full line of padlocks that will withstand harsh environmental conditions, rough handling and the test of time.



	Compact Safety Padlocks	Safety Padlock with Steel Shackle	Safety Padlock with Nylon Shackle	Long-Body Safety Padlock	Key Retaining Laminated Steel Padlocks	Laminated Steel Padlocks	Compact Aluminum Padlocks	Full Aluminium Padlocks
<b>Compact &amp; Lightweight</b>	✓	✓	✓	-	✓	-	✓	-
<b>Non-Conductive Body &amp; Keyway</b>	✓	✓	✓	✓	-	-	-	-
<b>Most Corrosion Resistant</b>	✓	✓	✓	✓	✓	✓	✓	✓
<b>Most Spark Resistant</b>	✓	✓	✓	✓	-	-	-	-
<b>Most Tamperproof</b>	-	✓	✓	✓	✓	✓	✓	✓
<b>Most Rugged</b>	-	✓	✓	✓	-	✓	-	✓
<b>Body Height &amp; Material</b>	1-2/5" Fiberglass Reinforced Nylon	1-3/4" Fiberglass Reinforced Nylon	1-3/4" Fiberglass Reinforced Nylon	3" Fiberglass Reinforced Nylon	1-1/5" Steel	1-1/3" Steel	1-1/4" Aluminium	1-3/5" Aluminium
<b>Shackle Size &amp; Material</b>	3/16" dia. 1" high Aluminum	1/4" dia. 1-1/2" high Steel	1/4" dia. 1-1/2" high Nylon	1/4" dia. 1-1/2" high Steel	17/64" dia. 3/4", 2" or 3" high Steel	17/64" dia. 3/4" or 2" high Steel	1/4" dia. 1" high Aluminium	1/4" dia. 1", 1-1/2" or 3" high Aluminium
<b>Colors</b>	BK, BL, BR, GR, OR, PL, RD, YL, WT	BK, BL, BR, GR, OR, PL, RD, YL, WT	BK, BL, BR, GR, OR, PL, RD, YL, WT	BK, BL, BR, GR, OR, PL, RD, YL, WT	BK, BL, BR, GR, RD, PL, YL, WT	BK, BL, BR, GR, OR, PL, RD, YL	BK, BL, BR, GR, OR, PL, RD, SL, YL	BK, BL, BR, GR, OR, PL, RD, SL, YL
<b>Identification Capabilities</b>	Engraving (front, back, left and right sides)	Engraving (front, back, left and right sides)	Engraving (front, back, left and right sides)	Engraving (front, back, left and right sides)	Engraving (front, back, left and right sides)	Engraving (front, back, left and right sides)	Engraving (front, back, left and right sides)	Engraving (front, back, left and right sides)
<b>Key Possibilities *denotes custom</b>	Keyed Different Keyed Alike	Keyed Different Keyed Alike Master Keyed* Grand Master Keyed*	Keyed Different Keyed Alike Master Keyed* Grand Master Keyed*	Keyed Different Keyed Alike Master Keyed* Grand Master Keyed*	Keyed Different Keyed Alike Master Keyed* Grand Master Keyed*	Keyed Different Keyed Alike Master Keyed* Grand Master Keyed*	Keyed Different Keyed Alike	Keyed Different Keyed Alike Master Keyed* Grand Master Keyed*
<b>Main Application</b>	Electrical applications, small and confined spaces	Industrial safety (process industry - custom applications)	Industrial safety (process industry - custom applications) Electrical applications	Industrial safety (process industry - custom applications)	Industrial safety, Severe physical environment	Severe physical environment, Industrial safety	Small space applications where light-weight and easy to carry locks are needed	Outdoor, Industrial Safety, Food & Beverage applications (FDA approved lubricant in cylinder)
<b>Main Features</b>	Non-conductive body, Compact & Light Weight, Key retaining system, Cylinder can support same keying system as regular safety padlock	Non-conductive body, Key retaining system, High security (6-pins)	Completely non-conductive lock, Key retaining system, High security (6-pin)	Non-conductive body, Key retaining system, High security (6-pins)	Physical resistance, Key retaining system, Superior corrosion resistance	Physical resistance, Superior corrosion resistance	Compact & Lightweight, Superior corrosion resistance	Superior corrosion resistance, Laser engraving
<b>Includes</b>	1 Key & Labels (EN, FR, SP)	1 Key & Labels (EN, FR, SP)	1 Key & Labels (EN, FR, SP)	1 Key & Labels (EN, FR, SP)	1 key Labels Sold Separately	2 keys Labels Sold Separately	2 keys Labels Sold Separately	2 keys Labels Sold Separately





## OSHA Lockout Tagout Regulations

**1910.147(c)(5) OSHA Lockout Device Requirements state that lockout devices must:**

- Be provided by the employer
- Be standardized by size, shape or color
- Be distinguishable from locks used for other purposes. Lockout locks should only be used for lockout!
- Identify the individual who applied the lock (both tags and lock labels are acceptable for this purpose)
- Be capable of withstanding the usage environment and must be strong enough to prevent removal except by using excessive force with special tools, such as bolt cutters.
- Most importantly, whenever lockout devices are applied, they must remain under the exclusive control of the individual who attached them. No employee should be able to open a lock attached by someone else.

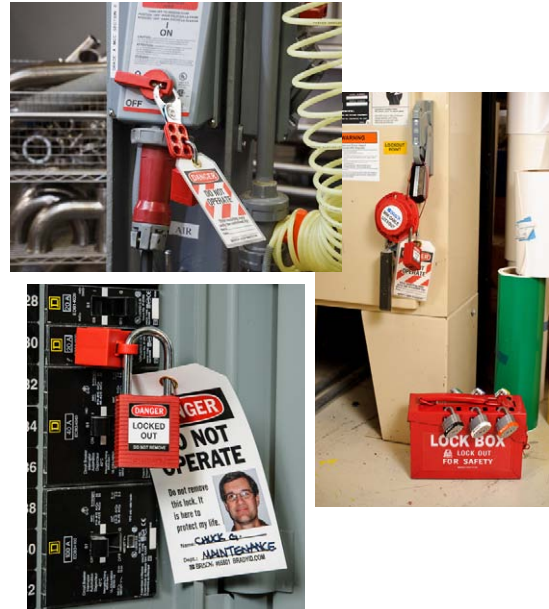

## Keying & Charting Options



### Keyed Different

Brady padlocks come “keyed different” when purchased from stock. This means that the key for one lock should not open another. Brady padlocks use 5- or 6-pin cylinders with keys precision machined to exacting standards. This enables us to offer a greater number of unique keys than other locks with the same number of pins, making it highly unlikely that you will ever receive a duplicate lock.



### Keyed Alike

When keyed alike, all locks in a set can be opened with the same key. This option is beneficial when multiple locks are assigned to a single employee. Remember, however, that under OSHA regulations no employee should be able to open a lock applied by someone else. Therefore, keyed alike locks from the same set should never be distributed to multiple employees.

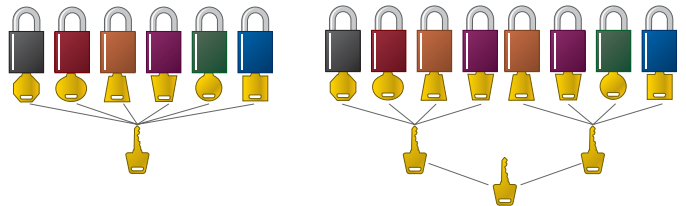

### Master and Grand Master Keyed

A master or grand master key can be used to open multiple locks that are keyed differently. This allows supervisors to easily remove a lock in the event of an emergency. In order for employees to retain exclusive control, master and grand master keys should be kept in a secure location that is accessible only to management.

### Key Charting

Brady can track or “chart” your key codes upon request to simplify ordering replacement locks and to avoid duplicates when ordering additional locks. There is no extra charge for charting. Call for Customer Service at 1-888-272-3946 details!



## Need a Customized Solution?

At Brady, we can help you with all of your custom lock needs. Brady customer service representatives are ready to answer your questions and get you started with:

- Custom Keying
- Logo and Text Engraving
- Serialization



# Safety Padlocks

BradyID.com/lockouttagout

Lockout Tagout



Actual size of Brady's Compact Safety Padlock



## Compact Safety Padlocks

- Extremely compact and lightweight - the smallest safety lock on the market
- Easily fits in small spaces - ideal for electrical contractors/maintenance/electricians
- 5-pin cylinder can support same keying system as our current Safety Padlock
- Fiberglass reinforced nylon body for extra impact resistance
- Service temperature: 0°–250° F (-20°–120° C)
- Lock body dimensions: 1-2/5"H x 1-1/5"W x 5/8"D  
Shackle clearance: 1"; shackle diameter 1/5"
- Each padlock includes 1 key and 1 each English, Spanish and French labels

### Compact Safety Padlocks - 1" Steel Shackle

Color	Keyed Different 1/Pack	Keyed Different 6/Pack	Keyed Alike 3/Pack	Keyed Alike 6/Pack
Red	143150	118926	118953	118954
Green	143152	118927	118955	118956
Orange	143154	118928	118957	118958
Blue	143156	118929	118959	118960
Yellow	143158	118930	118961	118962
Brown	143160	118931	118963	118964
White	143162	118932	118965	118966
Purple	143164	118933	118967	118968
Black	143166	118934	118969	118970

## Brady Safety Padlocks

- Comply with all OSHA requirements and are a safer alternative to metal locks for lockout applications
- Nonconductive body with unique key cylinder prevents electricity from traveling from the shackle to the key, protecting workers when key is inserted
- Superior temperature, chemical and corrosion resistance
- "Danger" and "Property of" labels provided in English, Spanish and French and printed on 100% recycled paper
- Reserved paracentric keyway provides optimal security (prevents someone from getting a copy made at a local key shop)
- Key-retaining feature prevents key from being removed until shackle is securely closed
- Locks come keyed differently or in keyed-alike sets. Custom keying and charting available
- Lock bodies can be custom laser engraved upon request
- One key is supplied with each padlock for safer key management



## Safety Padlocks

- Lightweight, nonconductive and non-sparking body
- Special 6-pin cylinder resists tampering
- Fiberglass reinforced nylon body and triple-coated hardened steel shackle
- Service temperature: 0°–250° F (-20°–120° C)
- Lock body dimensions: 1-3/4"H x 1-1/2"W x 4/5"D
- Shackle clearance: 1-1/2"; shackle diameter: 1/4"
- Each padlock includes 1 key and 1 each English, Spanish and French labels

### Safety Padlocks - 1-1/2" Steel Shackle

Color	Keyed Different 1/Pack	Keyed Different 6/Pack	Keyed Alike 3/Pack	Keyed Alike 6/Pack
Red	99552	51339	105886	105890
Green	99564	51345	105889	105893
Orange	99576	51347	123268	123270
Blue	99556	51344	105887	105891
Yellow	99570	51346	105888	105892
Brown	103033	101956	118947	118948
White	143123	118925	118949	118950
Purple	104919	104916	118951	118952
Black	99580	51353	123269	123271

When keyed alike, all locks in a set can be opened with the same key. This option is beneficial when multiple locks are assigned to a single employee.



## Compact Safety Padlock Kits

A great solution for any worker needing just “one lock and one tag”

Ideal for electrical lockout points, tight spaces, storefront use or vending solutions

Components:

- 1 - Compact Safety Padlock
- 1 - Heavy-duty Polyester (B-837) Lockout Tag with durable over-laminate that can be re-usable
- 1 - Nylon Cable Tie

## Compact Safety Padlock Kits

Catalog #	Lock Color	Qty
123143	Red	1
123144	Green	1
123145	Orange	1
123146	Blue	1
123147	Yellow	1
123148	Brown	1
123149	White	1
123150	Purple	1
123151	Black	1



## Safety Padlocks with Non-Conductive Nylon Shackle

- Lightweight, nonconductive and non-sparking body
- Special 6-pin cylinder resists tampering
- Fiberglass reinforced nylon body with non-conductive nylon shackle
- Lock body dimensions: 1-3/4”H x 1-1/2”W x 4/5”D
- Shackle clearance: 1-1/2”; shackle diameter: 1/4”
- Each padlock includes 1 key and one each English, Spanish and French labels

### Safety Padlocks - 1-1/2” Nylon Shackle

Color	Keyed Different 1/Pack	Keyed Different 6/Pack	Keyed Alike 3/Pack	Keyed Alike 6/Pack
Red	123324	123351	123333	123342
Green	123326	123353	123335	123344
Orange	123328	123355	123337	123346
Blue	123325	123352	123334	123343
Yellow	123327	123354	123336	123345
Brown	123330	123357	123339	123348
White	123332	123359	123341	123350
Purple	123331	123358	123340	123349
Black	123329	123356	123338	123347



## Long Body Safety Padlocks

- 3” long body has ample space for your most important identification information
- Lightweight, nonconductive and non-sparking body
- Special 6-pin cylinder resists tampering
- Fiberglass reinforced nylon body and triple-coated hardened steel shackle
- Service temperature: 0°–250° F (-20°–120°C)
- Lock body dimensions: 3”H x 1-1/2”W x 4/5”D
- Shackle clearance: 1-1/2”; shackle diameter: 1/4”
- Each padlock includes 1 key and one each English/Spanish and English/French labels

### Long Body Safety Padlocks - 1-1/2” Shackle

Color	Keyed Different 1/Pack	Keyed Different 6/Pack	Keyed Alike 3/Pack	Keyed Alike 6/Pack
Red	123405	123396	123414	123423
Green	123407	123398	123416	123425
Orange	123409	123400	123418	123427
Blue	123406	123397	123415	123424
Yellow	123408	123399	123417	123426
Brown	123411	123402	123420	123429
White	123413	123404	123422	123431
Purple	123412	123403	123421	123430
Black	123410	123401	123419	123428

When keyed alike, all locks in a set can be opened with the same key. This option is beneficial when multiple locks are assigned to a single employee.



# Steel Padlocks

BradyID.com/lockouttagout

Lockout Tagout



## Key Retaining Laminated Steel Padlocks

- Key retaining safety feature prevents key from being removed until closed
- Reinforced laminated steel withstands severe physical abuse while hardened steel shackle resists tampering, cutting, prying, and rusting
- Body plates individually coated for superior rust protection
- 5-pin cylinder offers more unique key cuts, better tamper resistance than conventional 4-pin locks
- Colored bumpers supplied for identification (custom stamping available)
- Made from recycled material
- Each padlock includes 1 key. Custom keying and charting also available. Lock labels sold separately.
- Shackle clearance: 3/4", 2" or 3"  
Shackle diameter: 17/64"  
Lock body: 1-1/5"H x 1-5/16"W x 1"D



**Key Retaining Steel Padlocks  
3/4" Shackle**

Color	Keyed Different 1/Pack	Keyed Different 6/Pack
Red	143126	118935
Green	143128	118936
Blue	143130	118937
Yellow	143132	118938
White	143134	118939
Black	143136	118940
Brown	123272	123280
Purple	123273	123281



**Key Retaining Steel Padlocks  
2" Shackle**

Color	Keyed Different 1/Pack	Keyed Different 6/Pack	Keyed Alike 3/Pack	Keyed Alike 6/Pack
Red	143144	118944	118977	118978
Green	143142	118943	118975	118976
Blue	143140	118942	118973	118974
Yellow	143148	118946	118981	118982
White	143146	118945	118979	118980
Black	143138	118941	118971	118972
Brown	123274	123282	123276	123278
Purple	123275	123283	123277	123279



**Key Retaining Steel Padlocks  
3" Shackle**

Color	Keyed Different 1/Pack	Keyed Different 6/Pack	Keyed Alike 3/Pack	Keyed Alike 6/Pack
Red	123244	123236	123252	123260
Green	123245	123237	123253	123261
Blue	123246	123238	123254	123262
Yellow	123247	123239	123255	123263
White	123248	123240	123256	123264
Black	123249	123241	123257	123265
Brown	123250	123242	123258	123266
Purple	123251	123243	123259	123267

When keyed alike, all locks in a set can be opened with the same key. This option is beneficial when multiple locks are assigned to a single employee.



## Laminated Steel Padlocks

- Reinforced laminated steel withstands severe physical abuse while hardened steel shackle resists tampering
- Body plates individually coated for superior rust protection
- 5-pin cylinder offers more unique key cuts, better tamper resistance than conventional 4-pin locks
- Colored bumpers supplied for identification
- Each padlock includes 2 keys. Custom keying and charting also available. Lock labels sold separately.
- Shackle clearance: 3/4" or 2"  
Shackle diameter: 17/64"  
Lock body: 1-1/3"H x 19/16"W x 7/8"D



**Steel Padlocks - 3/4" Shackle**

Color	Keyed Different 1/Pack	Keyed Different 6/Pack
Red	99500	51279
Blue	99504	51280
Green	99508	51281
Yellow	99512	51282
Orange	99516	51283
Black	99520	51284
Brown	101957	102696
Purple	104920	104917



**Steel Padlocks - 2" Shackle**

Color	Keyed Different 1/Pack	Keyed Different 6/Pack	Keyed Alike 3/Pack	Keyed Alike 6/Pack
Red	99524	51290	105894	105898
Blue	99528	51291	105895	105899
Green	99533	51292	105897	105901
Yellow	99539	51297	105896	105900
Orange	99543	51298	-	-
Black	99548	51299	-	-
Brown	101958	102698	-	-
Purple	104921	104918	-	-

When keyed alike, all locks in a set can be opened with the same key. This option is beneficial when multiple locks are assigned to a single employee.

# Aluminum Padlocks

BradyID.com/lockouttagout

Lockout Tagout



## Aluminum Padlocks

- Lightest-weight aluminum lock in the market and made from recycled material
- Aluminum shackle has superior spark and corrosion resistance
- Reserved paracentric keyway provides optimal security (prevents someone from getting a copy made at a local key shop)
- Anodized aluminum finish gives better fade resistance when used outdoors
- FDA approved lubricant in cylinder
- Shackle clearance: 1", 1-1/2" or 3"  
Shackle diameter: 1/4"
- Compact Lock body: 1-1/4"H x 1-1/4"W  
Compact Lock body features a 5-pin cylinder
- Regular Lock body: 1-3/5"H x 1-1/2"W x 3/4"D  
Regular Lock body features 6-pin cylinder which offers more unique key changes and better tamper resistance
- Each padlock includes 2 keys.  
Custom keying and charting also available.  
Lock labels sold separately.



### Compact Aluminum - 1" Shackle

Color	Keyed Different 1/Pack	Keyed Different 6/Pack	Keyed Alike 3/Pack	Keyed Alike 6/Pack
Red	133270	133261	133279	133288
Blue	133271	133262	133280	133289
Green	133272	133263	133281	133290
Yellow	133273	133264	133282	133291
Orange	133274	133265	133283	133292
Black	133275	133266	133284	133293
Brown	133276	133267	133285	133294
Purple	133277	133268	133286	133295
Silver	133278	133269	133287	133296

### Aluminum Padlocks - 1" Shackle

Color	Keyed Different 1/Pack	Keyed Different 6/Pack
Red	99608	51360
Blue	99609	51361
Green	99610	51362
Yellow	99611	51363
Orange	99612	51368
Black	99613	51369
Brown	104574	104575
Purple	104572	104573
Silver	123320	123322

When keyed alike, all locks in a set can be opened with the same key. This option is beneficial when multiple locks are assigned to a single employee.



### Aluminum Padlocks - 1-1/2" Shackle

Color	Keyed Different 1/Pack	Keyed Different 6/Pack	Keyed Alike 3/Pack	Keyed Alike 6/Pack
Red	99615	51370	105902	105882
Blue	99616	51371	105903	105883
Green	99617	51376	105881	105885
Yellow	99618	51377	105904	105884
Orange	99619	51378	123432	123437
Black	99620	50274	123433	123438
Brown	104578	104579	123434	123439
Purple	104576	104577	123435	123440
Silver	123321	123323	123436	123441

### Aluminum Padlocks - 3" Shackle

Color	Keyed Different 1/Pack	Keyed Different 6/Pack	Keyed Alike 3/Pack	Keyed Alike 6/Pack
Red	123293	123284	123302	123311
Blue	123294	123285	123303	123312
Green	123295	123286	123304	123313
Yellow	123296	123287	123305	123314
Orange	123297	123288	123306	123315
Black	123298	123289	123307	123316
Brown	123299	123290	123308	123317
Purple	123300	123291	123309	123318
Silver	123301	123292	123310	123319

When keyed alike, all locks in a set can be opened with the same key. This option is beneficial when multiple locks are assigned to a single employee.



**May we also suggest:**



**Custom Keying Solutions**

At Brady, we can help you with your custom keying program. Just call a Brady customer service representative at 1-888-272-3946 to get started!

---



**Combination Padlock**

Compact, lightweight lock with a steel shackle and a 4-digit resettable code

Catalog #	Description
101963	Combination Padlock



# Padlock Labels

BradyID.com/lockouttagout

Lockout Tagout



Padlock labels are a great way to quickly identify padlocks used for lockout tagout. They help send a clear message to workers when a machine is down for service or maintenance.



## Steel Padlock Labels

- Durable B-826 vinyl labels include overlaminates strips
- Labels accept pencil, pen or marker
- Designed to fit Steel Padlocks

Catalog #	Description	Size	Qty.
50280	English	3/4"H x 4-1/2"W	6
50281	Spanish	3/4"H x 4-1/2"W	6
50283	French	3/4"H x 4-1/2"W	6



## Steel Padlock Label

- Durable B-7569 vinyl labels accept pencil, pen or marker
- Designed to fit Steel Padlocks

Catalog #	Size	Qty.
121448	3/4"H x 5"W	40

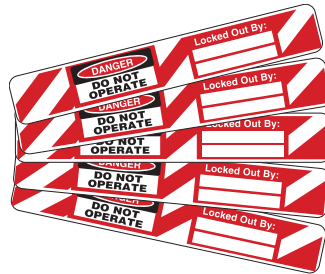

## Steel Padlock Label

- Durable B-7569 vinyl labels accept pencil, pen or marker
- Designed to fit Steel Padlocks

Catalog #	Size	Qty.
121449	5/8"H x 4.5"W	5



## Prinzing Lockout Labels

- Labels accept pencil, pen or marker
- Designed to fit Steel Padlocks

Catalog #	Size	Qty.
LID-3	3/4"H x 4.5"W	25



## Safety Padlock Labels

- Durable vinyl labels accept pencil, pen or marker
- Designed to fit Safety Padlocks
- Labels supplied with multiple languages

Catalog #	Description	Qty.
51379	English/Spanish/French	6 of each language



## Aluminum Padlock Labels

- Durable B-826 vinyl labels accept pencil, pen or marker
- Designed to fit Aluminum Padlocks

Catalog #	Description	Size	Qty.
50289	English	0.8"H x 1.1"W	6
50292	Spanish	0.8"H x 1.1"W	6
50293	French	0.8"H x 1.1"W	6



## Lock Label Overlaminates

- B-835 clear overlaminates protect existing lock label from dirt and grease
- Lock label sold separately

Catalog #	Description	Qty.
65508	1"H x 6"W overlaminates	40



## Padlock Stations

- Constructed of 14 gauge steel with red plastic coating
- Small station holds up to 4 padlocks (2-1/4"H x 3"W x 1-1/4"D)
- Large station holds up to 24 padlocks (3"H x 16"W x 1-1/4"D)

Catalog #	Description
LR060E	Small Padlock Station
LR360E	Large Padlock Station

\* Padlocks Sold Separately.



## Enclosed Padlock Storage Modules

- Constructed of sintra with lockable, transparent acrylic doors
- Provides safe storage and controls access to padlocks
- Small module holds 16 locks (15"H x 15"W x 3-1/2"D)
- Large module hold 40 locks (30"H x 15"W x 3-1/2"D)

Catalog #	Description
65240	Small Padlock Storage Module
65241	Large Padlock Storage Module

\* Padlocks Sold Separately.



## Steel Padlock Control Centers

- Constructed of red powder-coated 22 gauge steel
- Each metal hook can hold 2 locks
- Two keys supplied for cabinet lock
- Small center holds 16 locks (10"H x 12"W x 2"D)
- Large center hold 32 locks (15-1/2"H x 18"W x 2"D)

Catalog #	Description
LR008E	Small Padlock Control Center
LR018E	Large Padlock Control Center

\* Padlocks Sold Separately.

## Padlock Management System

- Reduces theft by controlling access to locks!
- Each lock is individually secured into a numbered port on the lock board
- Locks can only be removed by personnel with assigned access keys. Access key is retained in board until lock is returned.
- Call Brady Customer Service to place your order today!

### Specify the following to order your management system:

#### 1) LOCKS PER UNIT (Choose one)

- 5 locks (board size – 5-3/8"H x 21-3/8"W x 4"D)
- 10 locks (board size – 7"H x 21-3/8"W x 4"D)
- 15 locks (board size – 10"H x 21-3/8"W x 4"D)
- 25 locks (board size – 17-1/2"H x 21-3/8"W x 4"D)
- 50 locks (board size – 32-1/2"H x 21-3/8"W x 4"D)
- 75 locks (board size – 47-3/8"H x 21-3/8"W x 4"D)

#### 2) COLOR OF LOCKS (Total must equal choice above)

- Yellow \_\_\_Qty
- Green \_\_\_Qty
- Red \_\_\_Qty

#### 3) KEYING

- Keyed Alike
  - Keyed Different
  - Master Key w/ Keyed Alike
  - Master Key w/Keyed Different
- \_\_\_Qty of Master Keys      \_\_\_Qty of Master Keys

#### 4) COLOR OF ACCESS KEYS (Total must equal no. of locks)

- Yellow \_\_\_Qty
- Green \_\_\_Qty
- White \_\_\_Qty
- Blue \_\_\_Qty
- Red \_\_\_Qty
- Silver \_\_\_Qty

(Other colors also available)

\* For Keyed Alike or Master Keyed Padlocks call your local Brady Distributor for pricing.



This tracking system can also be used to secure a wide variety of plant assets, including employee issued tools, electronics and maintenance equipment.

### Specify the following to order ADDITIONAL LOCKS or access keys:

#### 1) ADDITIONAL LOCKS

- Yellow \_\_\_Qty
- Green \_\_\_Qty
- White \_\_\_Qty
- Blue \_\_\_Qty
- Red \_\_\_Qty
- Silver \_\_\_Qty

#### 2) KEYING

- Keyed Alike
  - Keyed Different
  - Master Key w/ Keyed Alike
  - Master Key w/Keyed Different
- \_\_\_Qty of Master Keys      \_\_\_Qty of Master Keys

#### 4) COLOR OF ACCESS KEYS (Total must equal no. of locks)

- Yellow \_\_\_Qty
- Green \_\_\_Qty
- White \_\_\_Qty
- Blue \_\_\_Qty
- Red \_\_\_Qty
- Silver \_\_\_Qty

(Other colors also available)

\* For Keyed Alike or Master Keyed Padlocks call your local Brady Distributor for pricing.

# Group Lockout Boxes

BradyID.com/lockouttagout

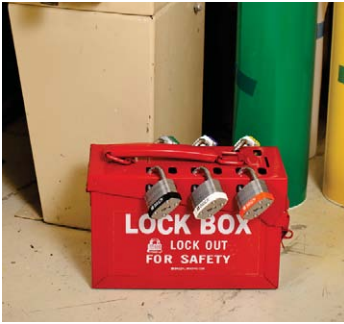

## Lockout Boxes - A great idea for group lockout

For group lockout situations involving a large number of workers and equipment, lock boxes can offer a number of advantages over hasps.

### How group lockout boxes work:

- Supervisor uses a single job lock on each energy control point to lock out equipment
- Keys for job locks are put in a lockout box
- Each worker applies his own lock to the lock box. As long as any one worker's lock remains on the lockout box, the keys to the job locks cannot be accessed, and the energy isolating devices cannot be operated. Each employee retains exclusive control, as required by OSHA.

### How group lockout boxes can save you money and increase efficiency:

- Example: Assume 5 workers need to lock out 10 energy control points
- Using hasps, 50 locks are required (all 5 workers must apply individual locks to each control point)
- Using a lockout box, only 15 locks are required (10 job locks applied to control points and 5 employee locks applied to lockout box). That's 70% fewer locks!
- Less weight hanging from the energy point - 1 lock instead of 5!
- Finally, checking the locks on the lock box allows you to track who is still working. With hasps, you need to walk around to each energy control point to see whose lock is still in place.



## SAFETY REDBOX™ Group Lockout Box

- Use as a portable or a mounted lockbox
- Quick release internal slide button allows lockbox to be carried to the point of need
- Can accommodate up to 12 padlocks
- Size: 6"H x 9"W x 3-1/2"D

Catalog #	Description	Color
145579	Mountable Lockbox	Red
145580	Mountable Lockbox	Yellow

\* Padlocks sold separately.



## Portable Metal Group Lockout Boxes

- Made of heavy duty steel, powder-coated for extra rust resistance
- 12 lock holes on lid, plus one lockable clasp on front
- Standard: 6"H x 9"W x 3-1/2"D  
Compartment holds up to 40 padlocks
- Extra large: 6"H x 7-3/8"W x 9-1/2"D  
Compartment holds up to 75 padlocks

Catalog #	Description	Size	Color
45190	Standard-English	6" x 9" x 3-1/2"	Blue
65672	Standard-English	6" x 9" x 3-1/2"	Yellow
65699	Standard-English	6" x 9" x 3-1/2"	Red
65040	Standard-Spanish	6" x 9" x 3-1/2"	Red
51171	XLarge-English	6" x 7-3/8" x 9-1/2"	Red

\* Padlocks Sold Separately.



## Combined Lock Storage / Group Lockout Box

- Made of heavy duty steel, powder coated for extra rust resistance
- Handy box features a lockable storage compartment and a group lockout compartment
- Lockout compartment has clear window with keyhole slot
- Standard Box: 12-1/2"L x 7-1/2"W x 6"D  
Compartment: 8-1/2"L x 6"W x 6"D  
Compartment holds approx. 50 locks. 17 lock holes in group lock box lid
- Large box: 15"L x 10 1/2"W x 9"D  
Compartment: 10-1/2"L x 9"W x 9"D  
Compartment holds approx. 125 locks 34 lock holes in group lock box lid

Catalog #	Description	Size
105716	Standard	12-1/2"L x 7-1/2"W x 6"D
105717	Large	15"L x 10-1/2"W x 9"D

\* Padlocks Sold Separately.



# Group Lockout Boxes

BradyID.com/lockouttagout



## Portable Plastic Group Lockout Box

- Durable plastic lockbox with transparent windows
- Excellent chemical and heat resistance
- Slot in front allows for keys to be inserted when box is locked
- Includes pre-drilled holes for easy wall-mounting
- 12 interior hooks for hanging keys/locks
- Lock rails hold up to 16 padlocks
- Dimensions: 7-1/2"H x 8-1/2"W x 4-1/4"D
- Patent Applied For

Catalog #	Description
50937	Portable Plastic Lock Box
50939	Extra Key Hooks (12/pkg)

\* Padlocks Sold Separately.



## Metal Wall-Mounted Group Lockout Boxes

- Made of durable, powder-coated steel with key slot on top
- Clear window slides out when locks are removed
- Comes with key pegs and ID labels to simplify key management
- Pre-drilled holes and hardware included for quick mounting
- Small lock box: 7"H x 8"W x 2-1/4"D  
7 key pegs that hold 5 keys each  
7 lock holes along bottom
- Large lock box: 7"H x 16"W x 2-1/4"D  
15 key pegs that hold 5 keys each  
12 lock holes along bottom

Catalog #	Description
105714	Small Metal Lock Box
105715	Large Metal Lock Box

\* Padlocks Sold Separately.



## Wall-Mounted Group Lockout Box

- Injection molded for extra durability
- Excellent chemical and heat resistance
- Slot in front allows keys to be inserted when locked
- Includes pre-drilled holes for easy wall-mounting
- 6 interior hooks for hanging keys/locks
- Lock rails hold up to 8 padlocks
- Dimensions: 6-1/5"H x 4"W x 5-1/2"D

Catalog #	Description
50938	Miniature Wall Lock Box
50939	Extra Key Hooks (12/Pkg)

\* Padlocks Sold Separately.



## Portable / Wall Group Lockout Box

- Made of yellow powder-coated metal
- Accommodates 8-10 locks
- Can be used alone or in combination with Metal Lockout Cabinet
- Dimensions: 6"H x 15"W x 3"D

Catalog #	Description
LG252M	Prinzing Metal Wall Lock Box

\* Padlocks Sold Separately.



## Acrylic Wall-Mounted Group Lockout Boxes

- Made of acrylic plastic with transparent front cover
- Includes pre-drilled holes for easy wall-mounting
- Pre-attached plastic hooks for hanging keys, tag stubs, etc.

Catalog #	Description	Max. Locks	# Key Hooks
LG003E	Small 6" x 6" x 2-1/2"	6	3
LG008E	Medium 7-1/2" x 12" x 2-1/2"	10	8
GLOBOX	Large 7-1/2" x 15-3/4" x 2-1/2"	14	18

\* Padlocks Sold Separately.



## SHOCK-STOP™ Group Lockout Box

- Combines lock box with storage board for hasps
- Lock box accommodates up to 6 locks and provides rail for storing locks
- Includes two SHOCK-STOP™ hasps, mounting hardware and instructions
- Dimensions:  
16-1/2"H x 10-1/2"W x 2-1/2"D

Catalog #	Description
87692	Group Lock Box (w/2 hasps)
87693	Hasp (5/pkg.)

\* Padlocks Sold Separately.



# Hasps

BradyID.com/lockouttagout

Lockout Tagout



## Steel Group Lockout Hasps

- Constructed of vinyl-coated high tensile steel w/ rust resistant plating
- Lock holes: 3/8" diameter

Catalog #	Description	Qty.
133161	1" Diameter Jaws	1
65375	1" Diameter Jaws	12
133162	1-1/2" Diameter Jaws	1
65376	1-1/2" Diameter Jaws	12



## Steel Group Lockout Hasps with Tabs

- Tamperproof interlocking tabs prevent unauthorized opening
- Case-hardened steel with rust proof plating and bright red vinyl insulation
- Lock holes: 3/8" diameter

Catalog #	Description	Qty.
105718	1" Diameter Jaws	1
105719	1-1/2" Diameter Jaws	1



## Corrosion-Resistant Group Lockout Hasps

- 12 gauge epoxy coated steel provides superior rust resistance and added dielectric strength
- Lock holes: 5/16" diameter

Catalog #	Description	Qty.
T218	1" diameter jaws	1
T220	1-1/2" diameter	1



## Aluminum Economy Group Lockout Hasps

- Non-sparking, aluminum small hasps are a great addition to your tool box
- Lightweight at only 1-1/2 ounces
- Lock holes: 3/8" diameter

Catalog #	Description	Qty.
105720	1" Diameter Jaws	1
105721	1-1/2" Diameter Jaws	1

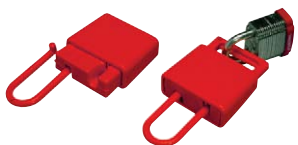

## Non-Conductive Group Lockout Hasps

- Strong, rigid plastic resin
- Excellent electrical insulating
- Performs at low temps, excellent heat resistance
- Patent #7,124,606

Catalog #	Description	Qty.
LH220A	Red Lockout Hasp	1



## Heavy Duty Lockout Hasp

- Hasp allows multiple workers to lockout at each isolation point
- Stainless steel construction
- Accommodates up to 1/3" dia. padlock shackles

Catalog #	Description	Qty.
871239	Heavy Duty Hasp	24



## Dual Jaw Hasp

- Dual construction allows for increased versatility in a single product
- Larger jaw measures 1.25" x 1.75"
- Smaller jaw measures 0.75" dia.

Catalog #	Description	Qty.
236919	Dual Jaw Hasp	1



## Non-Conductive Nylon Group Lockout Hasp

- Accommodate up to 6 locks
- Withstands up to 1,000 lbs despite weighing only 1 oz.
- Dimensions: 7"H x 1-3/4"W  
Lock holes: 3/8" diameter

Catalog #	Description	Qty.
99668	Nylon Lockout Hasp	1



## Labeled Group Lockout Hasps

- Tough 5052 anodized aluminum alloy hasps include tamperproof locking tabs
- Write-on label accepts pencil, pen or marker. Pen and pencil markings are easily erased for repeated use
- Dimensions: 7-1/4"H x 3"W x 3/16"D  
Lock holes: 5/16" dia.



Legend Option 1

Catalog #	Color	Qty.
65960	Red	5
65961	Silver	5
65962	Blue	5
65963	Green	5
65964	Gold	5
65967	Combo*	5



Legend Option 2

Catalog #	Color	Qty.
65970	Red	5
65971	Silver	5
65972	Blue	5
65973	Green	5
65974	Gold	5
65975	Combo*	5



Legend Option 3

Catalog #	Color	Qty.
39480	Red	5

\*Combo includes 1 each of the five colors listed above.

## Cable lockouts – GREAT VERSATILITY!

Cable lockouts provide a number of advantages. Because of their construction, cable lockouts can be used in a variety of applications locking out multiple disconnects and valves. They are also a great option for lockout of unusual energy isolating devices that cannot be effectively locked out by a traditional device. This versatility combined with ultimate portability makes cable lockout devices a great addition to any lockout tagout program.



### SAFELEX™ Universal Cable Lockout

- Integrated hasp and cable provides simple way to lockout multiple energy isolation points
- Lightweight construction is great for handling, carrying and operation

Catalog #	Description
145554	Lockout w/ 3 ft. steel cable
145553	Lockout w/ 6 ft. steel cable
145552	Lockout w/ 10 ft. steel cable
145551	Lockout w/ 15 ft. steel cable
145550	Lockout w/ 6 ft. non-conductive nylon cable
145549	Lockout w/ 10 ft. non-conductive nylon cable



### Double Looped Cables

- Light weight and easier to spot, these 3/16" diameter cables are perfect for situations requiring a flexible lockout device and a visual deterrent

### ProLock Cable Spool

- Economical, highly visible alternative to chains. For additional ProLock products, visit BradyID.com

Catalog #	Length	Color
<b>Double Looped Cables</b>		
131063	Double Looped Cable 2ft	Red
131064	Double Looped Cable 4ft	Red
131065	Double Looped Cable 6ft	Red
131066	Double Looped Cable 8ft	Red
<b>ProLock Cable Spool</b>		
122265	ProLock Cable 164ft (50m)	Green
122264	ProLock Cable 164ft (50m)	Yellow
122263	ProLock Cable 164ft (50m)	Red
122261	ProLock Cable 5ft (1.5m)	Yellow
122262	ProLock Cable 5ft (1.5m)	Green



### Original Cable Lockout

- Brady's original cable lockout
- Device constructed of impact modified nylon, available in red, blue or yellow
- Includes 6' galvanized steel cable (1/8" outside dia.)

Catalog #	Description	Color
65318	Cable Lockout Device w/ 6 ft. cable	Red
45191	Cable Lockout Device w/ 6 ft. cable	Blue
45192	Cable Lockout Device w/ 6 ft. cable	Yellow
65319	8 ft. steel cable only	-
65320	10 ft. steel cable only	-

\*Other cable lengths available upon request.



### All Purpose Cable Lockout

- Superior chemical, corrosion and temperature resistance properties
- Available with interchangeable 3/16" dia. sheathed metal or 1/8" dia. non-conductive nylon cables
- Service temps of cables:  
Non-Conductive Nylon: -40° to 200° F  
Sheathed Metal: -30° to 180° F

Catalog #	Description
50943	Lockout w/ 8' sheathed metal cable
50941	Lockout w/ 8' non-conductive nylon cable
50944	Lockout without cable
50947	8' Sheathed metal cable only
50950	12' Sheathed metal cable only
50953	16' Sheathed metal cable only
50956	20' Sheathed metal cable only
50945	8' Non-conductive nylon cable only
50948	12' Non-conductive nylon cable only
50951	16' Non-conductive nylon cable only
50954	20' Non-conductive nylon cable only



### Mini Cable Lockout

- Compact and portable with internally stored cable
- Push-button self-winding mechanism automatically cinches cable tight
- Superior chemical, corrosion and temperature resistant properties
- Includes either vinyl-coated steel cable or nonconductive nylon cable
- 6 lock holes accommodate most padlock shackles and hasps
- Body dimensions: 4" dia. x 1-3/4" deep  
Cable dimensions:  
1/16" outside dia. x 8' length

Catalog #	Description
50940	Mini Cable Lockout w/ Steel Cable
51442	Mini Cable Lockout w/ Nylon Cable

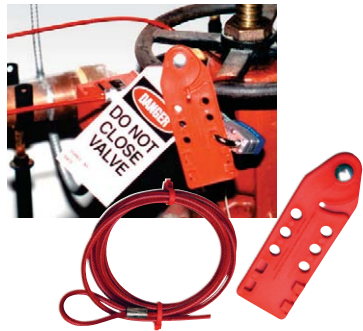

### Prinzing Economy Cable Lockout

- Unique lockout device accepts up to six 9/32" diameter padlocks
- Includes 6' or 10' plastic-coated steel cable
- Cable diameter: 3/16"

Catalog #	Description	Qty.
CABLO	Cable Lockout w/ 6' cable	1
CABLO-10	Cable Lockout w/10' cable	1
CABLE	6' Cable	1
CABLE-10FT	10' Cable	1

# Valve Lockouts

BradyID.com/lockouttagout

## Valve Lockouts

From universal valve lockouts to adjustable gate valve lockouts, Brady offers a full line of devices to shut off all types of pressured valves. Gate valve lockout devices deny access and cover the valve handle. With Prinzing ball valve lockouts and Brady's standard, quarter-turn ball valve lockout devices, a comprehensive series of options are available from the global leader in lockout tagout solutions.

### Universal Valve Lockout

Lock Out all Types of Valves with a Single Device

- Made of rugged industrial-grade steel and nylon for extra impact and chemical resistance
- Versatile open ended clamp fits over most closed rings, wide handles
- Can also lock out large levers, T handles, and other hard-to-secure mechanical devices
- Cable attachment offers choice of 1/8" nonconductive nylon or rustproof sheathed metal cable
- Small: for handle widths up to 1" (max handle thickness 0.6")
- Large: for handle widths up to 1.6" (max handle thickness 1.1")
- Patent No. 5,415,017 and 7,207,198



No need for multiple types and sizes of lockouts – now one device does it all!



Use blocking arm to lock out quarter-turn ball valves.



Attach to butterfly handles to prevent trigger handle from being squeezed.



Use cable attachment to lock out gate valves.



Use two blocking arms to lock out 3-, 4- or 5-way valves, or to lock valves in the "on", "off", or "throttled" position.

Catalog #	Description
<b>Complete Sets</b>	
51394	Small UVLO w/ 8' Sheathed Cable Attachment & Blocking Arm
51390	Small UVLO w/ 8' Nylon Cable Attachment & Blocking Arm
51392	Large UVLO w/ 8' Sheathed Cable Attachment & Blocking Arm
51388	Large UVLO w/ 8' Nylon Cable Attachment & Blocking Arm
<b>Individual Components</b>	
50924	Small UVLO Base Clamping Unit
50899	Large UVLO Base Clamping Unit
65402	Small Blocking Arm
65403	Large Blocking Arm
51395	Cable Attachment w/ 8-ft Sheathed Cable
50932	Cable Attachment w/ 8-ft Nylon Cable

Other cable lengths also available.

### Butterfly Valve Lockout

- Innovative design to lock out butterfly valves with a lever handle in the OFF position
- Will accommodate handle thicknesses of:  
Small - 1/8" to 2-1/2" (3.2mm to 63.5mm)  
Large - 2" to 4" (50.8mm to 102mm)

Catalog #	Description
121504	Butterfly Valve Lockout - Small
121505	Butterfly Valve Lockout - Large





## Plug Valve Lockout

- Ideal for difficult-to-secure plug valves in compliance with OSHA standards
- Four sizes to fit most 1" to 8" diameter manually-actuated plug valves
- Durable and tamper-resistant
- Service temps from -25°F to 200°F
- Compact in size and easy to use

Catalog #	Description
113231	Lockout for up to 7/8" Stem Dia.
113232	Lockout for 15/16" to 1-3/8" Stem Dia.
113233	Lockout for 1-3/4" to 2-1/8" Stem Dia.
113234	Lockout for 2-3/16" to 2-1/2" Stem Dia.



## Adjustable Gate Valve Lockout

- Versatile lockout adjusts to fit 1" to 6-1/2" valve handles, replacing 3 conventional gate valve lockouts
- Constructed of rugged injection-molded polypropylene
- Service temps from -13°F to 194°F
- Supplied with English, Spanish and French danger labels

Catalog #	Description
64057	Adjustable Gate Valve Lockout



## Gate Valve Lockouts

- Unique knockout center fits OS&Y or "rising stem" valves
- Made of rugged injection-molded polypropylene
- Service temps from -25°F to 200°F
- Accepts shackles up to 3/8" in dia.
- Supplied with English, Spanish and French danger labels

Fits Valve Handles Dia.	Red	Yellow	Green	Blue
1" to 2-1/2"	65560	65590	65595	65585
2-1/2" to 5"	65561	65591	65596	65586
5" to 6-1/2"	65562	65592	65597	65587
6-1/2" to 10"	65563	65593	65598	65588
10" to 13"	65564	65594	65599	65589



## Prinzing Ball Valve Lockout

- Made from ultra-tuff polypropylene
- Small size locks out pipes 1/2" to 2-1/2" in diameter
- Small size can also lock valves OPEN on pipes from 1/2" to 1-1/4" in diameter
- Large size locks out pipes 2" to 8" in diameter

Catalog #	Size	Color
BS07A-RD	Small	Red
BS08A-RD	Large	Red
BS07A-BU	Small	Blue
BS08A-BU	Large	Blue
BS07A-GN	Small	Green
BS08A-GN	Large	Green
BS07A-YW	Small	Yellow
BS08A-YW	Large	Yellow

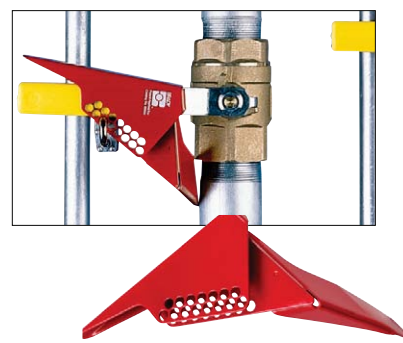

## Standard Ball Valve Lockout

- Easy to use, single-piece design locks quarter-turn ball valves in OFF position
- Two sizes fit most valves up to 3"
- 65666 is made of super-tough nylon (service temp -40° to 248° F)
- 65692, 65669 and 65693 are made of powder-coated steel

Catalog #	Max Shackle Dia.	Valve Size / Pipe Dia.	Max Handle Width	Max Handle Thickness
65666	932"	1/4" to 1"	1-1/2"	3/4"
65692	38"	1/4" to 1"	1-1/2"	3/4"
65669	932"	1-1/4" to 3"	2-1/10"	1 1/4"
65693	38"	1-1/4" to 3"	1-9/10"	1 1/4"



## Perma-Mount™ Ball Valve Lockout

- Retrofit devices stay permanently in place at the point of need
- One-time installation is easy to complete in just a few minutes
- Available in 2 sizes to fit a full range of 0.5" to 4" diameter ball valves

Catalog #	Size
121540	Small Perma-Mount Ball Valve Lockout
121541	Large Perma-Mount Ball Valve Lockout



# Lockout Tagout

BradyID.com/lockouttagout



## Circuit Breaker Lockout Compatibility Guide

Brady offers a wide variety of circuit breaker switch lockouts to isolate and secure most circuit breaker switches. From standard snap and clamp-on models to oversized, multi-pole and miniature options, Brady is sure to have what you need.

Use the guide below to find the correct circuit breaker solution for your circuit breakers. Detailed product information can be found on the following pages.

Brand	Model No.	Poles	Compatible Part #
ABB	E221	1	90844
ABB	E222	2	90844
ABB	E241	1	90844
ABB	E242	2	90844
ABB	E243	3	90844
ABB	E244	4	90844
ABB	E271	1	90844
ABB	E272	2	90844
ABB	E273	3	90844
ABB	E274	4	90844
ABB	F202AC	2	90850
ABB	F204AC	4	90850
ABB	F362	2	90844
ABB	F364	4	90844
ABB	F374	4	90844
ABB	F672	2	90850
ABB	F674	4	90850
ABB	JS	2-3	65397 (w/cleat)
ABB	S1	3	65396
ABB	S201-B	1	90844
ABB	S201-C	1	90844
ABB	S201-D	1	90844
ABB	S201-K	1	90844
ABB	S201P-K	1	90844
ABB	S201P-Z	1	90844
ABB	S201U-K	1	90844
ABB	S201U-Z	1	90844
ABB	S201UP-K	1	90844
ABB	S201UP-Z	1	90844
ABB	S202-B	2	90844
ABB	S202-C	2	90844
ABB	S202-D	2	90844
ABB	S202-K	2	90844
ABB	S202P-K	2	90844
ABB	S202P-Z	2	90844
ABB	S202U-K	2	90844
ABB	S202U-Z	2	90844
ABB	S202UP-K	2	90844
ABB	S202UP-Z	2	90844
ABB	S203-B	3	90844
ABB	S203-C	3	90844
ABB	S203-D	3	90844
ABB	S203-K	3	90844
ABB	S203P-K	3	90844
ABB	S203P-Z	3	90844
ABB	S203U-K	3	90844
ABB	S203U-Z	3	90844
ABB	S203UP-K	3	90844
ABB	S203UP-Z	3	90844
ABB	S204-B	4	90844
ABB	S204-C	4	90844
ABB	S204-K	4	90844
ABB	S204U-K	4	90844
ABB	S204U-Z	4	90844
ABB	S204UP-K	4	90844
ABB	S204UP-Z	4	90844
ABB	S221	1	90844
ABB	S222	2	90844
ABB	S222-K	4	90844

Brand	Model No.	Poles	Compatible Part #
ABB	S223	3	90844
ABB	S224	4	90844
ABB	S251	1	90844
ABB	S251	1	90844
ABB	S252	2	90844
ABB	S253	3	90844
ABB	S261	1	90844
ABB	S261-B	1	90844
ABB	S261-C	1	90844
ABB	S261-D	1	90844
ABB	S262-B	2	90844
ABB	S262-C	2	90844
ABB	S262-D	2	90844
ABB	S263	1	90844
ABB	S263-B	3	90844
ABB	S263-C	3	90844
ABB	S263-D	3	90844
ABB	S264-B	4	90844
ABB	S264-C	4	90844
ABB	S271-K	1	90844
ABB	S272	1	90844
ABB	S272-K	2	90844
ABB	S273-K	3	90844
ABB	S274-K	4	90844
ABB	S281-K	1	90844
ABB	S281-Z	1	90850
ABB	S281UC-K	1	90844
ABB	S281UC-Z	1	90850
ABB	S282-K	2	90844
ABB	S282-Z	2	90850
ABB	S282UC-K	2	90844
ABB	S282UC-Z	2	90850
ABB	S283-K	3	90844
ABB	S283-Z	3	90850
ABB	S283UC-K	3	90844
ABB	S283UC-Z	3	90850
ABB	S3	3	65397 (w/cleat)
ABB	S501-B	1	90850
ABB	S501-C	1	90850
ABB	S501-D	1	90850
ABB	S501-K	1	90850
ABB	S501UC-B	1	90850
ABB	S501UC-K	1	90850
ABB	S502-B	2	90850
ABB	S502-C	2	90850
ABB	S502-D	2	90850
ABB	S502-K	2	90850
ABB	S502UC-B	2	90850
ABB	S502UC-K	2	90850
ABB	S503-B	3	90850
ABB	S503-C	3	90850
ABB	S503-D	3	90850
ABB	S503-K	3	90850
ABB	S503UC-B	3	90850
ABB	S503UC-K	3	90850
ABB	S504UC-B	4	90850
ABB	S504UC-K	4	90850
AEG	E82S	2	90847
Airpax	Airpax	1	65396 (w/cleat)

Brand	Model No.	Poles	Compatible Part #
Allen Bradley	1492-CB1DF	1	90844
Allen Bradley	1492-CB1DG	1	90844
Allen Bradley	1492-CB1DH	1	90844
Allen Bradley	1492-CB1F	1	90844
Allen Bradley	1492-CB1G	1	90844
Allen Bradley	1492-CB1H	1	90844
Allen Bradley	1492-CB2DF	2	90844
Allen Bradley	1492-CB2DG	2	90844
Allen Bradley	1492-CB2DH	2	90844
Allen Bradley	1492-CB2F	2	90844
Allen Bradley	1492-CB2G	2	90844
Allen Bradley	1492-CB2H	2	90844
Allen Bradley	1492-CB3F	3	90844
Allen Bradley	1492-CB3G	3	90844
Allen Bradley	1492-CB3H	3	90844
Allen-Bradley	1492-CB1	1	90844
Allen-Bradley	1492-CB2	2	90844
Allen-Bradley	1492-CB3	3	90844
American Ckt. Bkr.	NEF	3	65396 (w/cleat)
American Ckt. Bkr.	NJ	3	65397 (w/cleat), 65329
American Switch	C	1	65396, 51252, 51254
Bryant	BR	2-3	66321, 51254
Bryant	BR	1	65387, 65396, 51254
Buschmat	S46	1	90844
Challenger	C	2-3	66321, 51254
Challenger	C	1	65387, 65396, 51254
Challenger	CDK	2-3	65397
Challenger	LM	1	65396
Challenger	NEJ	1-2	65396 (w/cleat), 51254
Clipsal	4CB	1-3	90844
Clipsal	4CB116	1	90844
Clipsal	4CB320	3	90844
Crouse-Hinds	MP	2	66321, 51254
Cutler-Hammer	BA	1	65396, 51254
Cutler-Hammer	BAB	2-3	66321
Cutler-Hammer	BAB	1	65387, 65396, 51254
Cutler-Hammer	BD	1	65387, 65396, 51254
Cutler-Hammer	BR	2-3	66321, 51254
Cutler-Hammer	BR	1	65387, 65396, 51254
Cutler-Hammer	BRH	2-3	66321, 51254
Cutler-Hammer	BRH	1	65387, 65396, 51254
Cutler-Hammer	BRHH	2	66321, 51254
Cutler-Hammer	CC	3	65397 (w/cleat)
Cutler-Hammer	CH	2-3	66321, 51254
Cutler-Hammer	CH	1	65387, 65396, 51252, 51254
Cutler-Hammer	CH2	4	66321, 51254
Cutler-Hammer	CHB	2-3	66321, 51254
Cutler-Hammer	CHB	1	65387, 65396, 51252, 51254
Cutler-Hammer	CHH	3	65396 (w/cleat)
Cutler-Hammer	CHKD	2-3	65397
Cutler-Hammer	CHLD	2-4	65329
Cutler-Hammer	CHMDL	2-3	65329
Cutler-Hammer	CHND	2-4	65397 (w/cleat)
Cutler-Hammer	CHP	2-3	66321, 51254
Cutler-Hammer	CHP	1	65387, 65396, 51252, 51254

## Circuit Breaker Lockout Compatibility Guide (continued)

Brand	Model No.	Poles	Compatible Part #	Brand	Model No.	Poles	Compatible Part #	Brand	Model No.	Poles	Compatible Part #
Cutler-Hammer	CHQ	1	65396, 51254	Cutler-Hammer	JD	2-4	65397	Cutler-Hammer	WMF	1-3	90844
Cutler-Hammer	CHQ	2	66321, 51254	Cutler-Hammer	JDB	2-3	65397	Cutler-Hammer	WMH	1-4	90844
Cutler-Hammer	CHSW	2-3	66321, 51254	Cutler-Hammer	JDC	2-4	65397	Cutler-Hammer	WMM	1-4	90844
Cutler-Hammer	CKD	2-3	65397	Cutler-Hammer	KD	2-4	65397	Cutler-Hammer	WMN	1-4	90844
Cutler-Hammer	CL	1	65387, 65396, 51252, 51254	Cutler-Hammer	KDB	2-4	65397	Cutler-Hammer	WMS	1-4	90844
Cutler-Hammer	CL	2	66321, 51254	Cutler-Hammer	KDC	2-4	65397	E-T-A	911225	1	90847
Cutler-Hammer	CLD	2-4	65329	Cutler-Hammer	LA	2-3	65397	E-T-A	911220G	2	90844
Cutler-Hammer	CLDC	2-4	65329	Cutler-Hammer	LD	2-4	65329	FAZ	C16	1-4	90844
Cutler-Hammer	CMDL	2-3	65329	Cutler-Hammer	LDB	2-3	65329	Fed. Pacific Elec.	2B	2	51254
Cutler-Hammer	CND	2-4	65397 (w/cleat)	Cutler-Hammer	LDC	2-4	65329	Fed. Pacific Elec.	BAB	1	65396, 51254
Cutler-Hammer	CNDC	2-4	65397 (w/cleat)	Cutler-Hammer	LH	3	65397	Fed. Pacific Elec.	NA-single	3	65397 (w/cleat), 51254
Cutler-Hammer	CSR	1	65396, 51254	Cutler-Hammer	LHB	3	65397	Fed. Pacific Elec.	NA-tie bar	2	51254
Cutler-Hammer	DK	2-3	65397	Cutler-Hammer	LJ	3	51254	Fed. Pacific Elec.	NB	1	65397 (w/cleat), 51254
Cutler-Hammer	E125B	1-4	65396, 51254	Cutler-Hammer	MA	2-3	65397 (w/cleat)	Fed. Pacific Elec.	NBH GFI	1	65396, 51254
Cutler-Hammer	E125E	1-4	65396, 51254	Cutler-Hammer	MC	2-3	65397 (w/cleat)	Fed. Pacific Elec.	NE/NEF	1-3	65396 (w/cleat)
Cutler-Hammer	E125H	1-4	65396, 51254	Cutler-Hammer	MD	2-3	65329	Fed. Pacific Elec.	NEJ	1-3	65396 (w/cleat)
Cutler-Hammer	E125S	1-4	65396, 51254	Cutler-Hammer	MDL	2-3	65329	Fed. Pacific Elec.	NFJ	1-3	65396
Cutler-Hammer	ED	2-4	65396, 51254	Cutler-Hammer	MDS	2-3	65329	Fed. Pacific Elec.	NJJ	1-3	65397
Cutler-Hammer	EDC	2-4	65396, 51254	Cutler-Hammer	NB	2-3	65329	Fed. Pacific Elec.	NJL	1-3	65397
Cutler-Hammer	EDH	2-4	65396, 51254	Cutler-Hammer	ND	2-4	65397 (w/cleat)	Fed. Pacific Elec.	NM	1-3	65397
Cutler-Hammer	EFH	1-4	65396, 51254	Cutler-Hammer	NDC	2-4	65397 (w/cleat)	Fed. Pacific Elec.	NP-single	1	65396, 51254
Cutler-Hammer	EGB	1-4	65396, 51254	Cutler-Hammer	OPTIM	3	65397 (w/cleat)	Frank Adams	P	1	65396, 51254
Cutler-Hammer	EGE	1-4	65396, 51254	Cutler-Hammer	PB	2-3	65329	FUJI Electric	BU-ESA	3	65396 (w/cleat)
Cutler-Hammer	EGS	1-4	65396, 51254	Cutler-Hammer	QBGF	1	65396	FUJI Electric	BU-ESB	3	65396 (w/cleat)
Cutler-Hammer	EHC	1-4	65396, 51254	Cutler-Hammer	QBGF	2	51254	FUJI Electric	BU-FSB	3	65396 (w/cleat)
Cutler-Hammer	EHD	1-4	65396, 51254	Cutler-Hammer	QBGFEP	1	65396	FUJI Electric	EA203B	3	65396 (w/cleat)
Cutler-Hammer	FB	2-3	65396, 51254	Cutler-Hammer	QBGFEP	2	51254	FUJI Electric	EA53B	3	65396 (w/cleat)
Cutler-Hammer	FC	1-4	65396, 51254	Cutler-Hammer	QBHG	1	65396	GE Vynckier	Series E	1-4	90847
Cutler-Hammer	FD	1-4	65396, 51254	Cutler-Hammer	QBHGFE	1	65396	GE Vynckier	Series G	1-3	90847
Cutler-Hammer	FDB	2-4	65396, 51254	Cutler-Hammer	QBHW	2-3	66321	General Electric	EH400	3	65397
Cutler-Hammer	FDC	2-4	65396, 51254	Cutler-Hammer	QBHW	1	65387, 65396, 51254	General Electric	HQC	3	65396, 51254
Cutler-Hammer	FS	2-3	65396, 51254	Cutler-Hammer	QC	2-3	66321, 51254	General Electric	SED	2-3	65396, 51254
Cutler-Hammer	GB	1-3	65396, 51254	Cutler-Hammer	QC	1	65387, 65396, 51254	General Electric	SEH	2-3	65396, 51254
Cutler-Hammer	GC	1-3	65396, 51254	Cutler-Hammer	QCD	2-3	66321, 51254	General Electric	SEL	2-3	65396, 51254
Cutler-Hammer	GD	1-3	65396, 51254	Cutler-Hammer	QCD	1	65387, 65396, 51254	General Electric	SEP	2-3	65396, 51254
Cutler-Hammer	GDB	1-3	65396, 51254	Cutler-Hammer	QCGF	1	65396	General Electric	SFH	2-3	65396, 51254
Cutler-Hammer	GHB	1-3	65396, 51254	Cutler-Hammer	QCGFEP	1	65396	General Electric	SFL	2-3	65396, 51254
Cutler-Hammer	GHBGFEP	1	65396, 51254	Cutler-Hammer	QCHGF	1	65396	General Electric	SFP	2-3	65396, 51254
Cutler-Hammer	GHC	1-3	65396, 51254	Cutler-Hammer	QCHGFEP	1	65396	General Electric	SGD	2-3	65396
Cutler-Hammer	GHC GFEP	1	65396, 51254	Cutler-Hammer	QCHW	2-3	66321, 51254	General Electric	SGH	2-3	65396
Cutler-Hammer	HBAW	2-3	66321	Cutler-Hammer	QCHW	1	65387, 65396, 51254	General Electric	SGL	2-3	65396
Cutler-Hammer	HBAW	1	65387, 65396, 51254	Cutler-Hammer	QHCW	2-3	66321, 51254	General Electric	SGLA	2-3	65396
Cutler-Hammer	HBAX	2-3	66321	Cutler-Hammer	QHCW	1	65387, 65396, 51254	General Electric	SGP	2-3	65396
Cutler-Hammer	HBAX	1	65387, 65396, 51254	Cutler-Hammer	QHCX	2-3	66321, 51254	General Electric	SRPG	3	65396
Cutler-Hammer	HFD	1-4	65396, 51254	Cutler-Hammer	QHCP	1	65387, 65396, 51254	General Electric	TB	2	65396 (w/cleat), 51254
Cutler-Hammer	HGHB	1	65396, 51254	Cutler-Hammer	QHPW	2-3	66321	General Electric	TBC	2	65396 (w/cleat), 51254
Cutler-Hammer	HGHC	1	65396, 51254	Cutler-Hammer	QHPW	1	65387, 65396, 51254	General Electric	TE	1-3	65396 (w/cleat), 51254
Cutler-Hammer	HJD	2-4	65397	Cutler-Hammer	QHPX	2-3	66321	General Electric	TEB	1-3	65396 (w/cleat), 51254
Cutler-Hammer	HKD	2-4	65397	Cutler-Hammer	QHPX	1	65387, 65396, 51254	General Electric	TED	1-3	65396 (w/cleat), 51254
Cutler-Hammer	HLD	2-4	65329	Cutler-Hammer	QPGF	1	65396	General Electric	TEF	1-3	65396 (w/cleat), 51254
Cutler-Hammer	HMCP	2-3	65396, 65397, 65329	Cutler-Hammer	QPGFEP	2	51254	General Electric	TEL	3	65396 (w/cleat), 51254
Cutler-Hammer	HMDL	2-3	65329	Cutler-Hammer	QPGFEP	1	65396	General Electric	TEML	3	65396 (w/cleat), 51254
Cutler-Hammer	HMDLB	2-3	65329	Cutler-Hammer	QPHGF	2	51254	General Electric	TEY	1-3	65396, 51254
Cutler-Hammer	HMPL	3	65397 (w/cleat), 65329	Cutler-Hammer	QPHGFEP	1	65396	General Electric	TF	1-3	65396, 51254
Cutler-Hammer	HND	2-4	65397 (w/cleat)	Cutler-Hammer	QPHGFEP	1	65396	General Electric	TFC	3	65396 (w/cleat), 51254
Cutler-Hammer	HQP	2	66321	Cutler-Hammer	QPHW	2-3	66321	General Electric	TFJ	2-3	65397
Cutler-Hammer	HQP	1	65387, 65396, 51254	Cutler-Hammer	QPHW	1	65387, 65396, 51254	General Electric	TFK	2-3	65397
Cutler-Hammer	HQP	1	65387, 65396, 51254	Cutler-Hammer	WME	1-3	90844	General Electric	TFL	3	65397

Lockout Tagout

## Circuit Breaker Lockouts Legend

Standard Circuit Breaker Lockouts					EZ Panel Loc™		Miniature Circuit Breaker Lockouts			
<b>65387</b> 120V Snap-On Lockout	<b>65396</b> 1120/277V Clamp-On Lockout	<b>65397</b> 480/600V Clamp-On Lockout	<b>65329</b> 480/600V Oversized Lockout	<b>66321</b> Universal Multi-Pole Lockout	<b>51252</b> Snap-On (SQD QO) Lockout	<b>51254</b> Clamp-On (Universal) Lockout	<b>90844</b> Pin-Out Standard Lockout	<b>90847</b> Pin-In Standard Lockout	<b>90850</b> Pin-Out Wide Lockout	<b>90853</b> Tie-Bar Lockout



## Circuit Breaker Lockout Compatibility Guide (continued)

Brand	Model No.	Poles	Compatible Part #	Brand	Model No.	Poles	Compatible Part #	Brand	Model No.	Poles	Compatible Part #
General Electric	THED	1-3	65396 (w/cleat), 51254	Merlin Gerin	C80A	3	90850, 90853	Siemens ITE	HHED6	2-3	65396, 51254
General Electric	THEF	1-3	65396 (w/cleat), 51254	Merlin Gerin	CE104N	3	65396 (w/cleat)	Siemens ITE	HHFD6	2-3	65397 (w/cleat)
General Electric	THFK	2-3	65397	Merlin Gerin	CJ	3	65397 (w/cleat)	Siemens ITE	HHJD6	2-3	65397
General Electric	THHQB	2-3	66321, 51254	Merlin Gerin	CK1200NA	3	65329	Siemens ITE	HHJXD6	2-3	65397
General Electric	THHQB-A	1	65387, 65396, 51254	Merlin Gerin	NC100H	1-3	90850	Siemens ITE	HJD6	2-3	65397
General Electric	THHQB-S	1	65396, 51254	Merlin Gerin	NC100L	1-4	90850	Siemens ITE	HJXD6	2-3	65397
General Electric	THHQC	1-3	66321, 51254	Merlin Gerin	NC100L MA	3	90850	Siemens ITE	HMD6	2-3	65329
General Electric	THHQC-A	1	65387, 65396, 51254	Merlin Gerin	NC100LH	1-4	90850	Siemens ITE	HMXD6	2-3	65329
General Electric	THHQC-S	1	65396, 51254	Merlin Gerin	NC100N	1-4	90850	Siemens ITE	HN3	2	65329
General Electric	THHQL	2-3	66321, 51254	Merlin Gerin	NC125H	1-3	90850	Siemens ITE	HND6	2-3	65329
General Electric	THHQL-A	1	65387, 65396, 51254	Proteus	C6	1	90844	Siemens ITE	HNXD6	2-3	65329
General Electric	THHQL-S	1	65396, 51254	Proteus	AC22BS5419	2	66321	Siemens ITE	HPD6	3	65329
General Electric	THJK4	2-3	65397 (w/cleat)	Proteus	BSEN60947-3	2	66321	Siemens ITE	HPXD6	3	65329
General Electric	THJK6	2-3	65397 (w/cleat)	Proteus	C16	1	90844	Siemens ITE	HQJ2-H	3	65396, 51254
General Electric	THKM12	2-3	65329	Proteus	C6	1-3	90844	Siemens ITE	HQP	1	65387, 65396, 51254
General Electric	THKM8	2-3	65329	Siemens ITE	5SN22	2	90853	Siemens ITE	HQP	2-3	66321, 51254
General Electric	THLC1	3	65396 (w/cleat)	Siemens ITE	5SQ11	1	90850	Siemens ITE	HQPP	1	65387, 65396, 51254
General Electric	THQB	2-3	66321, 51254	Siemens ITE	5SQ12	2	90853	Siemens ITE	HQPP	2-3	66321, 51254
General Electric	THQB-A	1	65387, 65396, 51254	Siemens ITE	5SQ13	3	90853	Siemens ITE	HQPPH	2	66321, 51254
General Electric	THQB-S	1	65396, 51254	Siemens ITE	5SQ16 4	4	90853	Siemens ITE	HRD6	3	65329
General Electric	THQC	2-3	66321, 51254	Siemens ITE	5SX11	1	90850	Siemens ITE	HRXD6	3	65329
General Electric	THQC-A	1	65387, 65396, 51254	Siemens ITE	5SX12	2	90853	Siemens ITE	JD2	3	65329
General Electric	THQC-AL	2-3	66321, 51254	Siemens ITE	5SX13	3	90853	Siemens ITE	JD6-A	2-3	65397
General Electric	THQC-S	1	65396, 51254	Siemens ITE	5SX21	1	90850	Siemens ITE	JJ3	3	65397
General Electric	THQD	2-3	65396 (w/cleat), 51254	Siemens ITE	BL	1	65387, 65396, 51254, 51254	Siemens ITE	JJ6	3	65329
General Electric	THQDBL	3	51254	Siemens ITE	BL	2-3	66321, 51254	Siemens ITE	JL3	3	65397
General Electric	THQL	2-3	66321, 51254	Siemens ITE	BLF-GFI	2	66321, 51254	Siemens ITE	JXD2-A	2-3	65397
General Electric	THQL-A	1	65387, 65396, 51254	Siemens ITE	BLH	1	65387, 65396, 51254	Siemens ITE	JXD6-A	2-3	65329
General Electric	THQL-S	1	65396, 51254	Siemens ITE	BLH	2-3	66321, 51254	Siemens ITE	KM3	3	65329
General Electric	TJ2	2-3	65397 (w/cleat), 65329	Siemens ITE	BQ	1	65387, 65396, 51254	Siemens ITE	LL3	3	65397
General Electric	TJ4	3	65397	Siemens ITE	BQ	2-3	66321, 51254	Siemens ITE	LL6	3	65329
General Electric	TJC	2-3	65396 (w/cleat), 51254	Siemens ITE	BQCH	1-3	65396, 51254	Siemens ITE	LXD6-ETI	3	65329
General Electric	TJD	2-3	65397 (w/cleat)	Siemens ITE	BOD	1-3	65396, 51254	Siemens ITE	MD6	2-3	65329
General Electric	TJJ	2-3	65397 (w/cleat)	Siemens ITE	BQH	1	65387, 65396, 51254	Siemens ITE	MXD6	2-3	65329
General Electric	TJK	2-3	65397 (w/cleat)	Siemens ITE	BQH	2-3	66321, 51254	Siemens ITE	MXD6-ETI	2-3	65329
General Electric	TJS	2-3	65397 (w/cleat)	Siemens ITE	BOH	2-3	66321, 51254	Siemens ITE	ND6	2-3	65329
General Electric	TK4V	3	65397	Siemens ITE	CED6	2-3	65396, 51254	Siemens ITE	NXD6	2-3	65329
General Electric	TKC	3	65396 (w/cleat), 51254	Siemens ITE	CFD6	2-3	65397 (w/cleat)	Siemens ITE	PD6	3	65329
General Electric	TKM	2-3	65329	Siemens ITE	CFD6-ETI	2-3	65397 (w/cleat)	Siemens ITE	PXD6	3	65329
General Electric	TKMA8	3	65329	Siemens ITE	CJ3	3	65397	Siemens ITE	QJ2	2-3	65396 (w/cleat), 51254
General Electric	TQB	2-3	66321, 51254	Siemens ITE	CJD6	2-3	65397	Siemens ITE	QJ2-H	2-3	65396 (w/cleat), 51254
General Electric	TQB-A	1	65387, 65396, 51254	Siemens ITE	CJD6-ETI	2-3	65397	Siemens ITE	QJH2	2-3	65396 (w/cleat), 51254
General Electric	TQB-S	1	65396, 51254	Siemens ITE	CLF	2	65397	Siemens ITE	QP	1	65387, 65396, 51254
General Electric	TQC	2-3	66321, 51254	Siemens ITE	CMD6	3	65329	Siemens ITE	QP	2-3	66321, 51254
General Electric	TQC-A	1	65387, 65396, 51254	Siemens ITE	CMD6-ETI	3	65329	Siemens ITE	QP1	1	65396, 51254
General Electric	TQC-S	1	65396, 51254	Siemens ITE	CND6	3	65329	Siemens ITE	QPH	1	65387, 65396, 51254
General Electric	TQD	2-3	65396	Siemens ITE	CPD6	3	65329	Siemens ITE	QPH	2-4	66321, 51254
General Electric	TQL-A	1	65387, 65396, 51254	Siemens ITE	CQD	1-3	65396 (w/cleat), 51254	Siemens ITE	QPP	1	65387, 65396, 51254
General Electric	TQL-S	1	65396, 51254	Siemens ITE	E2	1-3	65396, 51254	Siemens ITE	QPP	2-3	66321, 51254
General Electric	V	1-3	90847	Siemens ITE	E4	1-3	65396, 51254	Siemens ITE	QPPH	1	65387, 65396, 51254
General Electric	V	1-4	90847	Siemens ITE	ED	1-3	65396, 51254	Siemens ITE	QPPH	2-3	66321, 51254
Hager	453717	3	90844	Siemens ITE	ED4	1-3	65396, 51254	Siemens ITE	RD6	3	65329
Hager	MW216A	2	90844	Siemens ITE	ED6	1-3	65396, 51254	Siemens ITE	RXD6	3	65329
Hager	MW620A	4	90844	Siemens ITE	ED6-ETI	3	65396, 51254	Siemens ITE	SCMD6	3	65329
Heinemann	LB	1	65396 (w/cleat)	Siemens ITE	EE3	3	65396 (w/cleat), 51254	Siemens ITE	SCND6	3	65329
Heinemann	LF	1	65396 (w/cleat)	Siemens ITE	EH3	3	65396 (w/cleat), 51254	Siemens ITE	SHLD6-A	3	65329
Heinemann	LJ	1	65396 (w/cleat)	Siemens ITE	EQP	4	66321, 51254	Siemens ITE	SHMD6	3	65329
Kapp	LS68	1	90844	Siemens ITE	ET	3	65396 (w/cleat), 51254	Siemens ITE	SHND6	3	65329
Legrand	1908	1	90844	Siemens ITE	FD6A	2-3	65397 (w/cleat)	Siemens ITE	SHPD6	3	65329
Legrand	1935	3	90844	Siemens ITE	FJ2-B	2-3	65396 (w/cleat), 65397 (w/cleat)	Siemens ITE	SMD6	3	65329
Legrand	1980	3-4	90844	Siemens ITE	FJ3	2	65397	Siemens ITE	SN6	3	65329
Legrand	4302	2	90847	Siemens ITE	FJ6	2	65397 (w/cleat)	Siemens ITE	SPD6	3	65329
Legrand	6469	3	90847	Siemens ITE	FXD6-ETI	2-3	65397 (w/cleat)	Siemens ITE	VF3	3	65396
Lemag	SD62	1	65396	Siemens ITE	FXD6A	2-3	65397 (w/cleat)	Siemens 17U	5SQ16	4	90853
Merlin Gerin	B100A	2	90850, 90853	Siemens ITE	GF	1	65396, 51254	Siemens C10	5X1	1	90850
Merlin Gerin	B100A	2	90850, 90853	Siemens ITE	HBL	1	65387, 65396, 51254	Siemens C32	5SX1-2	2	90853
Merlin Gerin	C1251N	3	65329	Siemens ITE	HBL	2-3	66321, 51254	Siemens L20A	5SN2-2	2	90853
Merlin Gerin	C32N	1-3	90844	Siemens ITE	HBQ	1	65387, 65396, 51254	Square D	EDB	1-3	65396, 51254
Merlin Gerin	C45AD	3	90844	Siemens ITE	HBQ	2-3	66321, 51254	Square D	EDG	1-3	65396, 51254
Merlin Gerin	C60a	1-4	90844	Siemens ITE	HE4	1-3	65396, 51254	Square D	EH4	1-3	65396, 51254
Merlin Gerin	C60H	1-4	90844	Siemens ITE	HED4	1-3	65396, 51254	Square D	EBH	1-3	65396, 51254
Merlin Gerin	C60N	1-4	90844	Siemens ITE	HED6	2-3	65396, 51254	Square D	EBH	2-3	66321, 51254
Merlin Gerin	C801N	3	65329	Siemens ITE	HFD6	2-3	65397 (w/cleat)	Square D	EJB	1-3	65396, 51254
Merlin Gerin	C80A	3	90850, 90853	Siemens ITE	HFXD6	2-3	65397 (w/cleat)	Square D	EZ	3	65329

Lockout Tagout



## Circuit Breaker Lockout Compatibility Guide (continued)

Brand	Model No.	Poles	Compatible Part #	Brand	Model No.	Poles	Compatible Part #	Brand	Model No.	Poles	Compatible Part #
Square D	FA	1-3	65396 (w/cleat)	Square D	QO-VH	2-3	65387, 65396, 51252, 51254	Westinghouse	HQNP	3	65396, 51254
Square D	FAL	1-3	65396 (w/cleat)	Square D	QOB	1	51252	Westinghouse	HQP	1	65387, 65396, 51254
Square D	FC	3	65396 (w/cleat)	Square D	QOB	2-3	65387, 65396, 51252, 51254	Westinghouse	JA	2-3	65397
Square D	FCL	2-3	65396 (w/cleat)	Square D	QOB-H	2	51252	Westinghouse	JB	3	65397
Square D	FDA	2-3	65396, 51254	Square D	QOB-VH	2-3	66321	Westinghouse	JD	2-4	65397
Square D	FGA	3	51254	Square D	QOB-VH	1	65387, 65396, 51252, 51254	Westinghouse	JDB	3	65397
Square D	FH	1-3	65396 (w/cleat)	Square D	QOM1-VH	2	65396, 51254	Westinghouse	KA	3	65397 (w/cleat)
Square D	FHL	1-3	65396 (w/cleat)	Square D	QOM2-VH	2	65396, 51254	Westinghouse	KB	2-3	65397
Square D	FHL-DC	3	65396 (w/cleat)	Square D	QOU	1	51252	Westinghouse	LA	3	65397 (w/cleat)
Square D	FHP	3	65396 (w/cleat)	Square D	QOU	2-3	65396, 51252, 51254	Westinghouse	LB	3	65397
Square D	FI	3	65396 (w/cleat)	Square D	QOU w/ tie bar	2-3	66321, 51254	Westinghouse	LBB	3	65397
Square D	FIL	3	65396 (w/cleat)	Square D	QYU	1	51252	Westinghouse	LH	3	65397
Square D	FY	1	65396 (w/cleat)	Square D	Y1	1	65397	Westinghouse	MA	2-3	65397 (w/cleat)
Square D	GJL	3	65396 (w/cleat)	Sursum	EA53	3	90847	Westinghouse	MC	2-3	65397 (w/cleat)
Square D	KA	2-3	65396 (w/cleat)	Sylvania GTE	QC	2	66321, 51254	Westinghouse	MCC	2-3	65397 (w/cleat)
Square D	KAL	2-3	65396 (w/cleat)	Sylvania GTE	Type C	2	66321, 51254	Westinghouse	MCPO	3	65396 (w/cleat), 51254
Square D	KAP	2-3	65397	Thomas & Betts	F Frame	1-3	65396, 51254	Westinghouse	NB	2-3	65329
Square D	KC	2-3	65396 (w/cleat)	Toshiba	E225B	3	65396 (w/cleat)	Westinghouse	P	3	65396, 51254
Square D	KCL	2-3	65396 (w/cleat)	Westinghouse	BA	1-3	65387, 65396, 51254	Westinghouse	QBHW	1	65387, 65396, 51254
Square D	KH	2-3	65396 (w/cleat)	Westinghouse	BA w/ tie bar	2-3	66321	Westinghouse	QC	3	66321
Square D	KHL	3	65396 (w/cleat)	Westinghouse	BAB	1-3	65387, 65396, 51254	Westinghouse	QC	1	65387, 65396, 51254
Square D	KI	2-3	65396 (w/cleat)	Westinghouse	BR	1-3	65387, 65396, 51254	Westinghouse	QCHQ	1	65387, 65396, 51254
Square D	KIL	2-3	65396 (w/cleat)	Westinghouse	BR w/ tie bar	2-3	66321, 51254	Westinghouse	QHCW	1	65387, 65396, 51254
Square D	L2	3	65329	Westinghouse	BRH w/ tie bar	2-3	66321	Westinghouse	QHCV	1	65387, 65396, 51254
Square D	LA	2-3	65397 (w/cleat)	Westinghouse	CA	2	65396 (w/cleat)	Westinghouse	QHPW	1	65387, 65396, 51254
Square D	LAL	2-3	65397 (w/cleat), 65329	Westinghouse	DA	2-3	65397	Westinghouse	QPHW	1	65387, 65396, 51254
Square D	LAP	3	65397 (w/cleat), 65329	Westinghouse	DK	3	65397	Westinghouse	Quicklag P	1-3	65396, 51254
Square D	LC	3	65329	Westinghouse	EB	1-3	65396 (w/cleat), 51254	Westinghouse	RE	1-2	65396, 51254
Square D	LCP	3	65329	Westinghouse	ED	2-3	65396, 51254	Westinghouse	RH	3	65397
Square D	LH	2-3	65397 (w/cleat)	Westinghouse	EH	1-3	65396, 51254	Westinghouse	WPHX	1	65387, 65396, 51254
Square D	LHL	3	65397 (w/cleat), 65329	Westinghouse	EHB	1-3	65396 (w/cleat)	Wylex	WRS40/2	2	90844
Square D	LHP	1-2	65397 (w/cleat), 65329	Westinghouse	EHD	1-3	65396, 51254	Zinsco	HQB	3	65396, 51254
Square D	LXL	3	65329	Westinghouse	FA	3	65396 (w/cleat), 51254	Zinsco	QB	1	65396, 51254
Square D	MA	3	65329	Westinghouse	FB	2-3	65396 (w/cleat), 51254				
Square D	MA	2-3	65397 (w/cleat)	Westinghouse	FD	1-4	65396, 51254				
Square D	MAL	3	65329	Westinghouse	FDB	2-4	65396, 51254				
Square D	MH	2-3	65329	Westinghouse	FDC	2-4	65396, 51254				
Square D	MH	2-3	65397 (w/cleat)	Westinghouse	FP	3	65397 (w/cleat)				
Square D	MHL	2-3	65329	Westinghouse	GB	1-3	65396, 51254				
Square D	ML-1	3	65397 (w/cleat)	Westinghouse	GBH	1-3	65396, 51254				
Square D	ML-3	3	65329	Westinghouse	GHB	1-3	65396, 51254				
Square D	MXL	3	65329	Westinghouse	GR	3	65397				
Square D	Q1B	2-3	65396, 51254	Westinghouse	HBAW	1	65387, 65396, 51254				
Square D	Q1L	2-3	65396, 51254	Westinghouse	HBAX	1	65387, 65396, 51254				
Square D	Q2	2-3	65396 (w/cleat)	Westinghouse	HCA	3	65396 (w/cleat)				
Square D	Q2H	2-3	65396 (w/cleat)	Westinghouse	HFB	1-3	65396 (w/cleat)				
Square D	Q2L	2-3	65396 (w/cleat)	Westinghouse	HFD	1-4	65396, 51254				
Square D	Q2MT	2-3	65396 (w/cleat)	Westinghouse	HKD	3	65397				
Square D	Q4	2-3	65397 (w/cleat)	Westinghouse	HLA	3	65397				
Square D	Q4L	2-3	65397 (w/cleat)	Westinghouse	HLB	2-3	65397				
Square D	QO	1	51252	Westinghouse	HMC	3	65397				
Square D	QO	2-3	65387, 65396, 51252, 51254	Westinghouse	HMCP	3	65396 (w/cleat), 51254				
Square D	QO-H	2	51252	Westinghouse	HNC	3	65329				
Square D	QO-SWN	2-3	65387, 65396, 51252, 51254								
Square D	QO-VH	1	51252								

### Circuit Breaker Lockouts Legend

Standard Circuit Breaker Lockouts					EZ Panel Loc™		Miniature Circuit Breaker Lockouts			
<b>65387</b> 120V Snap-On Lockout	<b>65396</b> 1120/277V Clamp-On Lockout	<b>65397</b> 480/600V Clamp-On Lockout	<b>65329</b> 480/600V Oversized Lockout	<b>66321</b> Universal Multi-Pole Lockout	<b>51252</b> Snap-On (SQD QO) Lockout	<b>51254</b> Clamp-On (Universal) Lockout	<b>90844</b> Pin-Out Standard Lockout	<b>90847</b> Pin-In Standard Lockout	<b>90850</b> Pin-Out Wide Lockout	<b>90853</b> Tie-Bar Lockout

# Circuit Breaker Lockout

BradyID.com/lockouttagout

## EZ Panel Loc™ System

- Works on wide range of breakers, including single- and multi-pole configurations
- Can be used with most padlocks by making use of unique lock rail system
- Allows panel door to be closed even when lockouts are in place
- Accommodates multiple locks, facilitating group lockout activity without hasps
- Keeps weight off the breakers, protecting delicate electrical components from damage
- Positions locks and tags outside the panel, making sure lockout activity is clearly visible to anyone in the area
- Patent No. 6,727,441

(Not recommended for use with multilock hasps)

### Technical Information

- Lockout devices constructed of high-impact Isoplast polymers
- Cables are 2-ft. in length
- Lock rails made of durable isoplast polymers with acrylic adhesive backing
- Lock rails available in 4" or 8" lengths (with 7 or 15 lock loops)

## How EZ Panel Loc System Works



Lockout device is unlocked by inserting and turning the black plastic key.



1. Expose the super-bond adhesive on back of rail. Permanently affix to any location on the panel.



2. Attach the lockout device to the breaker and snap into locked position.



3. Pass plastic key through lock rail and attach lock, preventing key from sliding down cable and opening lockout device.



4. For group lockouts, run key through multiple loops in lock rail and apply locks. No hasps required! (Not recommended for use with multilock hasps)



5. Low-profile lockouts allow panel doors to be closed on most breaker panels.

## Covers Most 120V – 277V Breakers!

The EZ Panel Loc™ System comes in two different styles, accommodating an exceptionally wide range of breaker models.

### SNAP-ON

For use on Square D NQO and other breakers that have a hole in the switch tongue. Just align pins with hole and snap closed. Pins prevent switch from being thrown.

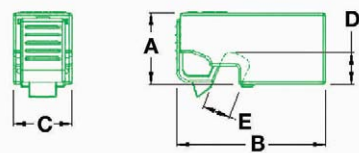

### CLAMP-ON

For use on breakers that do not have a hole in the switch tongue. Turn thumbscrew to clamp lockout securely onto switch, then snap the cover closed to prevent thumbwheel from being loosened.

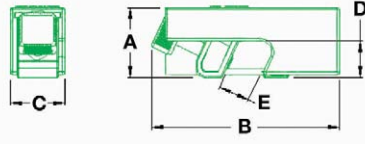

	Outer Dimensions (in.)			Switch Clearance (in.)	
	A	B	C	D	E
Snap-On Style	0.90"	1.88"	0.74"	0.40"	0.35"
Clamp-On Style	0.95"	2.56"	0.74"	0.35"	0.42"

Description	1 Per Pkg	6 Per Pkg
Snap-On Lockout Device	51252	65815
Clamp-On Lockout Device	51254	65810
4" Lock Rail	51256	65814
8" Lock Rail	51258	51260

## EZ Panel Loc™ Accessories



### Spacing Gasket

- For low profile panels, gasket pushes out the panel frame adding an additional 3/8" of clearance between the panel and the door
- Easy install with self-adhesive backing
- Dimensions: 3/8"D x 1"W x 15"L

Catalog #	Description
89256	EZ Panel Loc™ Spacing Gasket

# Circuit Breaker Lockout

BradyID.com/lockouttagout

Lockout Tagout



## 120V Snap-On Breaker Lockout

- Designed for 120V breakers with holes in the switch tongue
- Quick and easy – just snap in place and apply lock!
- Dual cavities accommodate different size switch tongues
- Accepts lock shackles up to 9/32" dia.
- Dimensions: 0.83"H x 0.35"W x 2.15"L

Catalog #	Description	Qty.
65387	120V Snap-On Circuit Breaker Lockout	1
65688	120V Snap-On Circuit Breaker Lockouts	6



## Clamp-On Breaker Lockout

- Extremely versatile – works on a wide range of single-pole and internal-trip multi-pole breakers!
- Use thumbscrew to clamp lockout onto switch tongue, then pull cover over thumbscrew and lock in place to prevent clamp from being loosened
- Accepts lock shackles up to 9/32" dia.
- Included detachable cleats expand the range of applicable breakers

Catalog #	Description	Qty.
65396	120/277V Clamp-On Lockout	1
65965	120/277V Clamp-On Lockout	6
65397	480/600V Clamp-On Lockout	1
65966	480/600V Clamp-On Lockout	6
65404	Extra Cleats For 120/277V Lockout	6
65406	Extra Cleats For 480/600V Lockout	6

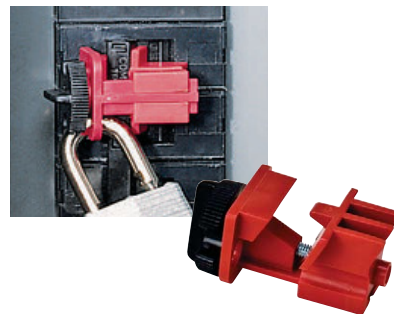

## Universal Multi-Pole Breaker Lockout

- Single device works with most major multi-pole breakers that employ a tie-bar
- Made of durable impact-modified nylon
- Compatible with GE, ITE, Sylvania, Challenger, Bryant, Westinghouse, General Switch Co., and more!
- Use thumbscrew to clamp lockout securely over tie bar, then insert lock to prevent clamp from being loosened
- Patent No. 5,300,740

Catalog #	Description	Qty.
66321	Universal Multi-Pole Breaker Lockout	1
66320	Universal Multi-Pole Breaker Lockouts	6

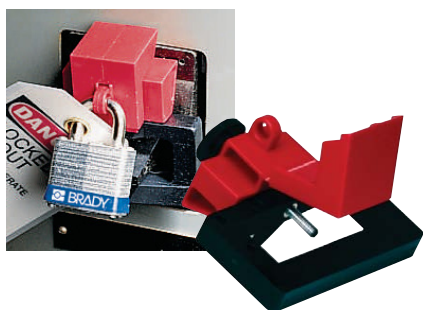

## Oversized Clamp On Breaker Lockout

- Oversized 480/600V frame lockout fits breaker switches up to 2-1/4" wide and 7/8" thick
- Made of durable polypropylene and glass filled-impact-modified nylon
- Patent No. 5,500,495

Catalog #	Description	Qty.
65329	Oversized Breaker Lockout	1
65321	Oversized Breaker Lockout	6

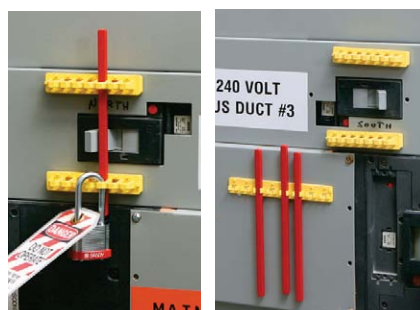

## 480-600V Breaker Blocker

- Ideal for oversized and irregularly shaped switches
- Self-adhesive backed rails are permanently installed onto an electrical panel – simply clean panel surface and adhere – no drilling required!
- Blocking Bars are 7-1/2" long
- Red blocking bar indicates locked off, green bar indicates locked on

Catalog #	Description	Qty.
90892	7.6" Red Blocking Bar	5
90893	7.6" Green Blocking Bar	5
51264	4" Yellow Mounting Rails	2
51265	Blocking Bar Holder	5
90891	Breaker Block Kit*	1

\*Kit includes 2 yellow mounting rails, 1 red blocking bar, 1 green blocking bar and 3 alcohol wipes.



## Five Steps to Compliance Whitepaper

Download this whitepaper to get started on a 5 step plan that will help you comply with OSHA's Lockout/Tagout regulations and keep your employees safe.

Download now at:  
[BradyID.com/5steps](http://BradyID.com/5steps)



# Circuit Breaker Lockout

BradyID.com/lockouttagout

## Miniature Circuit Breaker Lockouts

- A safe and effective method for locking out miniature circuit breakers, commonly used in European and Asian equipment
- NO TOOLS required for installation! The Lockout is easily installed with a push button. Tie Bar style lockouts have a convenient thumb wheel for quick application..
- Available for single and multi-pole breakers
- Lock with Brady Safety Padlocks (not included). Devices can support padlocks with a shackle diameter up to 9/32"
- Material: Glass-filled nylon

### 4 Different types:

- POS - Pin Out Standard
- PIS - Pin In Standard
- POW - Pin Out Wide
- TBLO - Tie Bar Lockout



Pin-Out Standard (POS)



Pin-In Standard (PIS)



Pin-Out Wide (POW)



Tie-Bar Lockout (TBLO)



Catalog #	Type	Qty.
90844	POS - Pin Out Standard	1
90845	POS - Pin Out Standard	6
90847	PIS - Pin In Standard	1
90848	PIS - Pin In Standard	6
90850	POW - Pin Out Wide	1
90851	POW - Pin Out Wide	6
90853	TBLO - Tie Bar Lockout	1
90854	TBLO - Tie Bar Lockout	6



## Miniature Circuit Breaker Compatibility Chart

Brand	Poles	Model No.	Type	Catalog # (1/pkg)
ABB	1	S222	POS	90844
ABB	1	F374	POS	90844
ABB	1	S251, S261, S263	POS	90844
ABB	1	S272, S253	POS	90844
ABB	3	S253	POS	90844
AEG	2	E82S	PIS	90847
Allen-Bradley	1,2,3	1492-CB1, 2, 3	POS	90844
Buschmat	1	S46	POS	90844
Clipsal	1	4CB116	POS	90844
Clipsal	3	4CB320	POS	90844
E-TA	1	911225	PIS	90847
E-TA	2	911220G	POS	90844
FAZ	4	C16	POS	90844
FAZ	1	C16	POS	90844
GE Vynckier	3	Series E	PIS	90847
GE Vynckier	3	Series G	PIS	90847
GE Vynckier	4	Series E	PIS	90847
GE Vynckier	1	Series G	PIS	90847
GE Vynckier 16A	2	Series E	PIS	90847
GE Vynckier C16, 16A	1	Series E	PIS	90847
Hager	3	453717	POS	90844
Hager	2	MW216A	POS	90844
Hager	4	MW620A	POS	90844
Kapp	1	LS68	PIS	90844
Legrand	2	1935	TBLO	90844
Legrand	3	1980	TBLO	90844

Brand	Poles	Model No.	Type	Catalog # (1/pkg)
Legrand	4	1980	TBLO	90844
Legrand	2	4302	PIS	90847
Legrand	3	6469	PIS	90847
Legrand	1	1908	POS	90844
Merlin Gerin	3	C80A	TBLO, POW	90850, 90853
Merlin Gerin	2	B100A	TBLO, POW	90850, 90853
Merlin Gerin	1	C60N	POS	90844
Merlin Gerin	1	C32N	POS	90844
Merlin Gerin	2	C60N	POS	90844
Merlin Gerin	4	C60N	POS	90844
Merlin Gerin	3	C32N	POS	90844
Merlin Gerin	3	C45AD	POS	90844
Proteus	1	C16	POS	90844
Proteus	1	C6	POS	90844
Proteus	3	C6	POS	90844
Siemens 17U	2	5SQ12	TBLO	90853
Siemens 17U	3	5SQ13	TBLO	90853
Siemens 17U	4	5SQ16	TBLO	90853
Siemens 17U	1	5SQ11	POW	90850
Siemens C10	1	5SX1	POW	90850
Siemens C32	2	5SX1-2	TBLO	90853
Siemens C70	3	5SX13	TBLO	90853
Siemens L20A	2	5SN2-2	TBLO	90853
Sursum	3	EA53	PIS	90847
Wylex	2	WRS40/2	POS	90844



## 3-In-1 Electrical Plug Lockout

- Accommodates high and low-voltage plugs up to 3" in diameter and 5-1/2" in length
- 2 sliding top lids can be used individually or together to accommodate small, medium and large-diameter cords up to 1-1/4"
- Constructed of yellow thermoplastic
- Visual label supplied in English/Spanish bilingual format

Catalog #	Type
PL023	3-in-1 Plug Lockout



## Brady Electrical Plug Lockouts

- Plug lockouts prevent electrical plugs from being inserted into a wall outlet. Use when plug will not remain under the exclusive control of the person performing service or maintenance
- Constructed of rugged polypropylene
- Small 110V plug lockout: 2"H x 2"D x 3-1/2"W with 1/2" dia. hole for cable
- Large 220/500V plug lockout: 3-1/4"H x 3-1/4"D x 7"W with 1" dia. hole for cable

Catalog #	Type
65674	Small 110V Plugout
65675	Large 220/500V Plugout

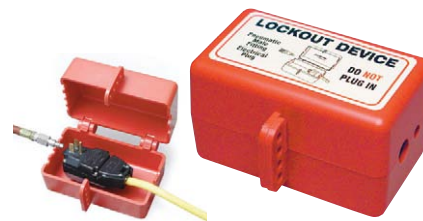

## Electrical/Pneumatic Plug Lockout

- Accommodates a large variety of electrical plugs up to 3-1/2" in diameter and 5" in length as well as male air hose connectors
- Holes accommodate electrical cord or "necked down" pneumatic male fittings commonly attached to compressed air hose
- Works on 110V, 220V & 550V plugs
- Constructed of durable polystyrene

Catalog #	Type
PLO27E	Electrical/Pneumatic Plug Lockout



## Hubbell Plugout™

- Two sizes available to fit most heavy industrial plug applications
- Small version accepts plugs with maximum 2-3/4" diameter and 4-3/4" length with 1" cord
- Large version accepts plugs with maximum 4-1/2" diameter and 10-3/20" length with 19/20" cord

Catalog #	Type
65695	Small Plugout™
65968	Large Plugout™



## Stoppower™ Plug Lockouts

- Ideal for office equipment and other frequently locked out cords
- For use on 2 or 3 pronged polarized plugs
- Cord cannot be plugged in with Stoppower™ in place
- Device cannot be removed without key

Catalog #	Type	Qty.
65673	Red Stoppower Plug (keyed different)	1
QB0033	Red Stoppower Plug (keyed alike)	1



## Wall Switch Lockouts

- Use with most wall-mounted switches
- Easy to install using existing screws
- 65392 & 65696 come in a high visibility red color and can lock switch in "on" or "off" position
- WSLO features a patented non-hinge design is made of strong, clear polycarbonate

Catalog #	Description	Qty.
65392	Red Wall Switch Lockout	1
65696	Red Wall Switch Lockout	6
WSLO	Clear Wall Switch Lockout	1

\*Padlock not included



## Electrical Lockout Kits

Brady's Electrical Lockout Tagout Kits include an array of hasps, clamp-on breaker lockouts, tags mini cable lockouts and much more.

View **page 442** for a variety of Lockout Kits.



# Electrical Lockouts & Tools

BradyID.com/lockouttagout



## Push Button and E-Stop Safety Covers

- Universal fit for IEC & NEMA buttons
- Removable, transparent red cover allows view of button position
- Hinged eyelet accepts safety locks
- Each base supplied with one yellow and one red label

Catalog #	Description	Fits	Qty.
134018	Sm. base & short cover	16mm button	1
130819	Sm. base & tall cover	16mm button	1
130820	Med. base & cover	22mm button	1
130821	Lrg. base & cover	30mm button	1



Push Button Cover NEMA 30.5 mm (PBL6)



Push Button Cover IEC 22.5mm (PBL8)

## Push Button Safety Covers

- 104602: Clear Lexan hinged cover completely covers button, and prevents access. White legend plate included
- 104603: Clear Lexan & metal hinged cover completely covers button preventing access

Catalog #	Type
PBL6	Push Button Safety Cover - NEMA 30.5 mm
PBL8	Push Button Safety Cover - IEC 22.5 mm



## Safe-T-Grip® Fuse Pullers

- Provides maximum convenience when removing or replacing cartridge fuses
- Notched handles for non-slip grip
- Clearly marked amperage ranges
- Exceeds MIL specifications

Catalog #	Description
65279	5" long Fuse Puller for 9/32"-1/2" dia. fuses
65280	7-1/2" long Fuse Puller for 0-100A, 250V & 600V



## Push Button and E-Stop Cover Bases

- One-time installation of low profile base
- Personnel can apply their portable safety cover to any installed base
- Fast and convenient lockout at the point of need
- Each base supplied with one yellow and one red label

Catalog #	Description	Fits	Qty.
130822	Small bases	16mm button	5
130823	Medium bases	22mm button	5
130824	Large bases	30mm button	5



Emergency Stop Cover NEMA 30.5mm (PBL2)



Emergency Stop Cover IEC 22.5mm (PBL4)

## Emergency Stop Safety Covers

- Permanently install over push/pull or twist-release emergency stops
- Durable metal bar locks button in the depressed (off) position when lock shackle is inserted

Catalog #	Type
PBL2	Emergency Stop Cover - NEMA 30.5 mm
PBL4	Emergency Stop Cover - IEC 22.5 mm



## AC Sensor

- Selected by OSHA Electrical Technical Equipment Committee as the only instrument of its type for use by OSHA compliance officers to identify and cite electrical hazards of 50-1000 volts AC
- CAT IV rated and UL Listed
- Patent #5,103,165

Catalog #	Description
65269	AC Sensor



## Universal Fuse Lockout

- Designed to prevent the un-intended re-energization of an energy source through a fuse.
- Easy to use device fits most fuse holders between 20 and 400 amps
- Dimensions: 1.38"H x 0.59"W x 2.36"D

Catalog #	Description	Qty.
873367	Universal Fuse Lockout - Red	1

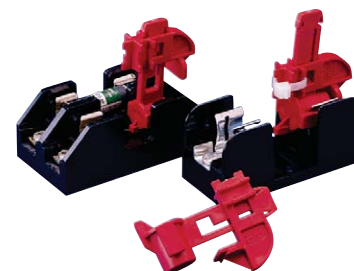

## Fuse Lockout Device

- Unique locking mechanism prevents device from being accidentally removed from fuse block
- Available in two sizes for most commonly used fuses

Catalog #	Description	Qty.
65750	Fuse Lockout size 13/32"	6
65751	Fuse Lockout size 9/16"	6



## Fuse Blockout Device

- Use small blockout device to fit fuses 1/4", 9/32", 13/32" & 9/16" in size
- Use large blockout to fit 13/16", 11/16" & blade type fuses

Catalog #	Description	Qty.
65690	Small Fuse Blockout	6
65691	Large Fuse Blockout	6



## Pneumatic Quick-Disconnect Lockout

- Isolates pneumatic energy without the expense and inconvenience of installing in-line lockout valves
- Device is applied to the male fitting, isolating equipment from all compressed air sources
- Accommodates the majority of 1/4", 1/8", 1/2" male fittings
- Hole in center of device allows for permanent storage on an air hose and a loop on the side can be used to hang the hose and lockout device
- Accommodates padlock with up to 1/4" shackle

Catalog #	Description	Qty.
64221	Pneumatic Lockout	1
65645	Pneumatic Lockout	6



## Prinzing Gas Cylinder Lockout

- Prevents access to the main cylinder valve
- No need to match your lockout device to varying diameters and threads of cylinder caps
- Accommodates neck rings up to 3-1/2" diameter
- Easy and efficient installation saves you time

Catalog #	Description
LM023E	Gas Cylinder Lockout



## SMC Air Line Regulator Lockout

- Enables regulator to be locked in the on, off or throttled position
- Easy installation: remove snap cap, install lockout on regulator rod, snap replacement cap on regulator
- Comes with lockout, cap and allen wrench. Padlock not included

Catalog #	Description
64539	Lockout for Miniature SMC Models AR2000 / NAR2000
64540	Lockout for Intermediate SMC Models AR3000 / NAR3000



## Snap Cap™ Gas Cylinder Lockout

- Designed to fit most North American high and low pressure gas cylinders
- Meets DOT standards
- Denies access to the main cylinder control and regulator attachment
- Powder coated welded steel construction is extremely durable

Catalog #	Description	Color
90496	6.5" x 3-1/8" x 11 UN, High Pressure Fine Thread	Yellow
95137	6.5" x 3-1/2" x 11 UN, Low Pressure Fine Thread	Yellow
95138	6.5" x 3-1/8" x 11 UN, High Pressure Coarse Thread	Yellow
95139	6.5" x 3-1/2" x 11 UN, Low Pressure Coarse Thread	Yellow



## Prinzing Cylinder Tank Lockout

- Used to lockout cylinder tanks, including propane tanks on fork trucks and stand alone propane tanks
- Apply with ease to prevent access to the valve handle
- Designed to fit in tight spaces
- Valve stem hole is 1.25" in diameter
- Made of rugged polystyrene plastic

Catalog #	Description
SD02M	Cylinder Tank Lockout

## Want to learn more about Lockout Tagout?

- Download the 5 Steps to an Effective Lockout Tagout Program Whitepaper
- View Brady's full line of Lockout Tagout product solutions

BradyID.com/lockouttagout



# Lockout Training & Awareness Aids

BradyID.com/lockouttagout

## OSHA Training Requirements:

- Those who will perform servicing or maintenance (authorized employees) must be trained to:
  - Recognize hazardous energy sources and understand the energy type and magnitude
  - Identify and properly operate the applicable energy-isolating devices
  - Safely apply and remove Lockout Tagout devices
- Those who operate the machinery or work in the area where LOTO is performed (affected employees) must be trained to:
  - Recognize when Lockout Tagout activities are in progress
  - Understand the purpose of the energy control program and the importance of not tampering with Lockout Tagout devices when encountered in the workplace
- Additional training is required when using tagout instead of lockout. See Section (C)(7)(ii) in the 1910.147 standard.
- Employers must document when training took place, who attended, and the topics covered.
- Employees must be retrained under the following situations:
  - Employee assigned to new job
  - Change made to energy control policies or procedures
  - Machinery installed or modified, presenting a new hazard
  - Whenever the employer has reason to believe that there are problems with the employee's understanding or use of the procedures
- Authorized employees must undergo an annual review to ensure they fully understand their responsibilities under the program



### Lockout Tagout Handbook

- 16-page training booklet with quiz instructs workers how to protect themselves from hazardous energy

Catalog #	Description	Qty.
66219	Lockout Tagout Handbook	10
63004	Spanish-language Handbook	10



### Lockout Safety Training Booklet

- 16-page training booklet covers the basics of Lockout Tagout safety

Catalog #	Description	Qty.
2112-TEN	Lockout Safety	10
2112	Lockout Safety	25
2112SP-TEN	Lockout Safety - Spanish	10
2112SP	Lockout Safety - Spanish	25



### Wallet Safety Cards

- Wallet size card contains important reminders for lockout safety

Catalog #	Description	Qty.
LOSC13	English Wallet Card	10
LOSC13 BI	English/Spanish Wallet Card	10

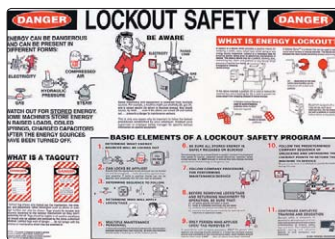

### Prinzing Lockout Safety Poster

- Training poster reinforces your energy control program
- 18"H x 24"W, laminated on both sides

Catalog #	Description
LOSP8	Lockout Safety Poster
LOSP8SP	Spanish-language version

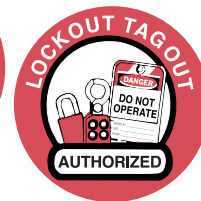

### Hard Hat Labels

- 2" diameter hard hat labels made of self-sticking indoor/outdoor grade vinyl
- A convenient way to identify first aid personnel, authorized operators and visitors to your facility

Catalog #	Description	Qty.
42248	Lockout Tagout Trained	4
50193	Lockout Tagout Authorized	4



# Lockout Training & Awareness Aids

BradyID.com/lockouttagout



Available on DVD or USB

## Lockout Tagout Safety Training Video: Global Best Practice Training

- Comprehensive training video features targeted regulatory and compliance content
- 5 languages included: English, Spanish, French, Portuguese, and Simplified Chinese
- Includes Instructor's Guide, Employee Quiz and 25 min video that:
  - Clearly defines and explains Lockout Tagout
  - Overviews compliance standards and regulations from countries around the world
  - Outlines an effective four-step Lockout Tagout program for employers
  - Covers important subtopics in-depth such as handling group lockout and shift changeovers
  - Bonus Feature: 19 short installation videos on how to use some of the most common lockout devices



Catalog #	Description
132426	LOTO Global Training Video DVD
132427	LOTO Global Training Video USB
833918	LOTO Global Training Video USB - European Supplies information in English, French, Dutch, German, Portuguese, Italian, Spanish, Turkish, Polish and Russian

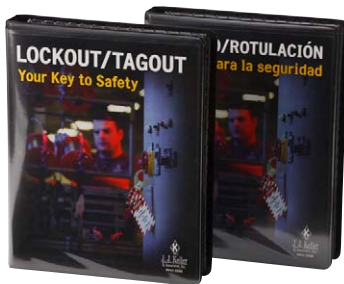

## Lockout Tagout: Your Key To Safety

- Train employees to protect themselves and others during machine servicing and maintenance. This program shows how to recognize all potential hazards and handle them safely. Includes:
  - Live action 20 minute, DVD video
  - 24 page Instructor guidebook
  - 11 employee handbooks
  - 1 - Trainer Tools CD-ROM
  - 1 - Awareness Poster

Catalog #	Description	Qty.
104275	Complete Kit - DVD version - English	1
104216	Complete Kit - DVD version - Spanish	1

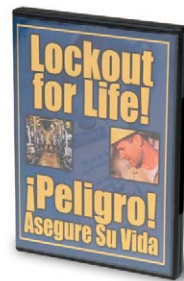

## Lockout For Life

- Learn from other workers' tragic mistakes. This motivational video presents six real-life dramatizations of actual lockout accidents and analyzes how they could have been prevented
- Suitable for new and experienced employees
- Run time: 19 minutes

Catalog #	Description
66255	Lockout For Life VHS video (includes 10 English booklets)
51793	Lockout For Life DVD English/Spanish video (includes 10 English booklets)
51544	Lockout For Life VHS Spanish video (includes 10 English booklets)
65555	Additional English booklets (10/pkg)

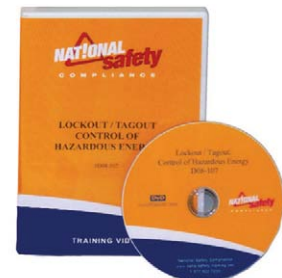

## LOTO for Authorized & Affected Personnel

- Provides a comprehensive introduction to the key components of an effective LOTO program
- Comes with reproducible quiz and certificate
- Spanish language video also available (quiz and certificate in English only)
- Run time: 17 minutes (DVD format)

Catalog #	Description
51454	LOTO For Authorized & Affected Personnel DVD (English)
51455	LOTO For Authorized & Affected Personnel DVD (Spanish)



# Lockout Tagout Procedures

BradyClientServices.com

## Lockout Tagout Procedures

Written procedures are a critical piece of an effective lockout tagout program. They provide clear, visually-intuitive instructions and specific steps necessary for shutting down, isolating, blocking and securing equipment to control hazardous energy. When employees can easily understand lockout procedures, they are more likely to utilize the procedures for safe machine lockout.

Brady's software programs and procedure writing service provide you with options to complete these procedures.

**!** **OSHA Lockout Tagout Regulations**

**29 CFR 1910.147 (c)(4)**

Machine-specific Lockout Tagout procedures are required for equipment having more than one energy source, as well as for much equipment having a single energy source.

Lockout Tagout

Clearly identifies the number of lockout points requiring attention for proper shutdown.

Lockout/Tagout Posted Procedure

ID#: BRDY-001-430105	Facility: Site 1 - Refrigeration	Location: Engine Room
Created: 9/11/2013	Description: Refrigeration Compressor #4	
Revised: 9/13/2013		

5 Lockout Points

**Note:** This is an example of Link360's "Long Form". The long form allows you to freely define the actions of each step, add photos for each step, and add further detail that is required for complex lockout procedures. For simple lockout procedures, see the "Short Form".

**Purpose:** This procedure establishes the minimum requirements for the lockout of energy isolating devices whenever maintenance or servicing is done on machines or equipment.

**Scope:** This procedure shall be used to ensure that the machine or equipment is stopped, isolated from all potentially hazardous energy sources and locked out before employees perform any servicing or maintenance where the unexpected energization or start-up of the machine or equipment or release of stored energy could cause injury.

**Authorization:** This procedure shall only be used by employees that have been trained as "Authorized" employees under OSHA 1910.147. Employees with the following job roles are authorized to use this procedure: <list job roles>

**Enforcement:** Failure to properly follow lockout-tagout procedure may result in corrective action.

Lockout Application Process

1. Notify affected personnel. 2. Properly shut down machine. 3. Isolate all energy sources. 4. Apply lockout devices, locks, & tags. 5. Verify total de-energization of all sources.

Lockout Steps		
Step #	Action	Info
1 <span style="color: red; font-weight: bold;">E-1</span> 480V	<p style="color: red; font-weight: bold; margin: 0;">PROPER PPE REQUIRED:</p> <p style="color: red; font-size: 0.8em; margin: 0;">Arc flash shield, 8 cal/cm2, class E gloves, electrical rated hardhat.</p> <p style="font-size: 0.8em; margin: 5px 0 0 0;">The E-1 Disconnect is located to the West of the machine. Turn Disconnect to the off position and lock out. Use a Lock and hasp device.</p>	
2 <span style="color: blue; font-weight: bold;">I-1</span>	<p style="font-size: 0.8em; margin: 0;">For the next step, you will need to obtain a universal lock and chain device from the Lockout/Tagout Station, located on the West wall of the Engine Room.</p>	<p style="font-size: 0.8em; margin: 0;">Upon re-energization, return universal lock and chain device to the Lockout/Tagout Station.</p>

Facility and location are prominently stated to minimize any chance of confusion.

Step by step written instructions detail the requirements for appropriate lockout.

Incorporated images help convey the message to your entire workforce.

# Lockout Tagout Procedures

BradyClientServices.com



## A Snapshot of LINK360® Software:

- Cloud-based software with free mobile apps
- Create and update procedures and permits
- Facilitate reviews, comments and approvals
- Setup regularly scheduled audit processes and reminders
- Time-stamping and record keeping
- Comprehensive procedure management tool

## LINK360® Software

Brady's LINK360® cloud based software is the first software to give you a complete view of the activities associated with creating, reviewing and updating visual information while driving internal employee engagement and accountability. LINK360 includes three modules: lockout/tagout, confined space and reliability.

The LINK360 Lockout/Tagout Application helps companies:

- Receive compliance assistance with OSHA 1910.147 for lockout of hazardous energy sources
- Manage lockout/tagout programs
- Create visually instructive safety procedures, tags and energy source labels for printing
- Gain 24-hour access with our free mobile app for iOS, mobile phones and tablets

**Interested in a demo?**

**Call 1-888-311-0774 or email [ClientServices@bradycorp.com](mailto:ClientServices@bradycorp.com)**



## Lockout Tagout Procedure Writing Service

This turnkey service is the most effective, stress-free way to create an OSHA-compliant lockout/tagout program. You can trust our field engineers to take care of every detail, including:

- Evaluating your needs and equipment requirements
- Creating visually-instructive procedures specific to your machinery, facility and employee safety requirements
- Laminating and installing the new lockout/tagout procedures
- Installing color-coded energy source ID tags
- Collaborating with your team during the process, helping you understand how to successfully maintain the program in-house

**For more information, visit**

**[BradyClientServices.com](http://BradyClientServices.com) or call 1-888-272-3946**



# Lockout Tagout Procedures

BradyID.com/lockouttagout

Post procedures near the point of need so they are easy to find and readily accessible.



## Lockout Procedure Station

- Silk-screened backboard made from durable polystyrene
- Includes pre-drilled holes and hardware for wall mounting
- 3-ring, 1.5" binder made from 55 gauge polyethylene
- Station dimensions: 20"Hx14"Wx4.5"D

Catalog #	Description
LOSP22	Lockout Procedure Station With Binder & 25 Forms
99289	Lockout Procedure Station With Binder Only
LOSB1	Lockout Procedure Binder Only
LOSF5	Lockout Procedure Forms (25/pk)



## Lockout Clip Board

- Heavy duty, red clipboard allows lockout information and hardware to be conveniently carried directly to the lockout location
- Clipboard can also be hung in place using attached strap
- Lockout safety tips silk-screened onto the back
- Procedures, locks and hasps sold separately

Catalog #	Description
LOCB	Lockout Clip Board

**OSHA Requirement**

**29 CFR 1910.147 (c)(4)**

Machine-specific Lockout Tagout procedures are required for equipment having more than one energy source, as well as for much equipment having a single energy source.

**OTHER WAYS OF PROVIDING ACCESS TO PROCEDURES**

- Print procedures to adhesive or magnetic labels and adhere to directly to machine.
- Attach procedures to work orders manually or by linking the digital procedure file to work orders generated in a computer maintenance management system
- Provide access to procedures online, allowing workers to view and print procedures from their own computer



## Protective Envelopes

- Transparent, durable vinyl construction
- Ideal for indoor or outdoor use
- Protects tags and cards on machinery, valves, switches, controls, and more
- Available with a variety of closure and mounting features

Catalog #	Description	Size	Qty.
81769	Magnetic Backed	4.5" x 6.5"	10
81770	Magnetic Backed	5.5" x 8.5"	10
81771	Adhesive Backed	4.5" x 6.5"	10
81772	Adhesive Backed	5.5" x 8.5"	10
81765	Zip-lock w/o Grommet	4.5" x 6.5"	10
81767	Zip-lock w/o Grommet	5.5" x 8.5"	10
81766	Zip-lock w/ Grommet	4.5" x 6.5"	10
81768	Zip-lock w/ Grommet	5.5" x 8.5"	10
81763	Open-Ended	4.5" x 6.5"	10
81764	Open-Ended	5.5" x 8.5"	10



## Fluorescent Protective Envelopes

- Clear envelopes with fluorescent edging, great for color-coding lockout procedures and other shop information
- Durable 8 gauge vinyl construction withstands harsh environments
- Ideal for indoor or outdoor use

Catalog #	Size	Color	Qty.
56941	9" x 9"	Fluorescent Green	25
56945	9" x 12"	Fluorescent Green	25
56942	9" x 9"	Fluorescent Orange	25
56946	9" x 12"	Fluorescent Orange	25
56944	9" x 9"	Fluorescent Yellow	25
56948	9" x 12"	Fluorescent Yellow	25



## Adhesive & Magnetic Backed Envelopes

- Made of non-glare clear vinyl material
- Size: 8-1/2" x 11"

Catalog #	Color	Qty.
50961	Adhesive Backed Envelopes	10
50962	Magnetic Backed Envelopes	10

# Lockout Tagout Signs & Labels

BradyID.com/lockouttagout



## Energy Source ID Requirements

- OSHA 1910.333(e) and (f) require that all disconnecting means show the magnitude and shall be legibly marked to indicate the purpose, unless located and arranged so the purpose is evident.
- ANSI Z244.1-2003, **Control of Hazardous Energy**, states that all energy isolating devices should be adequately labeled or marked unless they are located so that their purpose is clearly evident. Identification shall include:
  - Machine, equipment, process supplied
  - Energy type and magnitude



86248 3-1/2" x 5" B-302 5/pk



86250 3-1/2" x 5" B-302 5/pk



86216 3-1/2" x 5" B-302 5/pk

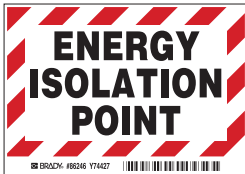

86246 3-1/2" x 5" B-302 5/pk



86245 3-1/2" x 5" B-302 5/pk



86204 3-1/2" x 5" B-302 5/pk

## Lockout Safety Labels

A variety of Lockout Tagout Labels made of durable, self-sticking polyester (B-302) are available to identify energy sources.

[More Lockout Labels on page 224.](#)



## Over 200 Lockout Tagout Safety Signs Available!

Brady carries a wide range of Lockout Tagout Signs to keep you and your employees safe around energy sources and equipment. Lockout Safety signs come in durable materials including plastic, aluminum and self-sticking vinyl.

[More Lockout Signs on page 118.](#)



### PRINZING Floor Stand

- Made from rugged polyethylene, resists most chemicals
- Message printed on front and back

Catalog #	Description	Size
SF647E	Lockout Floor Stand	7" x 10"

(side 1)



(side 2)

### Two-In-One Floor Stand

- Lightweight corrugated polypropylene (B-836) is printed on inside and out - offering two stands for the price of one

Catalog #	Description	Size
92289	Two-In-One Floor Stand	20" x 12"



### Magnetic Signs

- Made of flexible magnetic vinyl

Catalog #	Legend	Size
66004	Breakers Locked Out	5" x 3-1/2"
66005	Breakers Locked Out	7" x 5"
66006	Do Not Operate	5" x 3-1/2"
66007	Do Not Operate	7" x 5"
66008	Equip Being Serviced	5" x 3-1/2"
66009	Equip Being Serviced	7" x 5"

# Brady Client Services

BradyClientServices.com



## Visual Workplace Services Brady Client Services

**Improve workplace safety with visuals.**

Sustainability and safety expertise are the backbone to each of our field service offerings. From Visual Workplace Audits and Installation Services to Visual Procedure Writing Services and Safety Training Seminars, Brady Client Services' safety practitioners partner with you to create a safe, best-practice workplace you can maintain for years to come.

### Visual Procedure Writing Services

When utilizing Brady's Procedure Writing Services, you can rest assured that your procedures will be created and installed by industry experts who author over 26,000 procedures annually. In addition to creating OSHA-compliant procedures, we employ industry best practices to create highly visual, standardized procedures that make it easy for employees to use in their everyday work environment. Procedure writing services include: Lockout Tagout, Confined Space and Safe Operating Procedure Writing Services.



Contact a safety practitioner today to see how we can help you improve your visual workplace.

**1-888-311-0774**  
**BradyClientServices.com**



## Lockout/Tagout Procedure Writing Service

**The foundation of a successful, compliant lockout program is highly visual, standardized procedures** placed where employees use them most – directly on machinery and equipment. Our field engineers take care of every detail including:

- Evaluating your needs and equipment requirements by identifying potential hazardous energy sources
- Authoring all visual procedures within our LINK360® software or a format of our client's choosing
- Printing, laminating and installing procedures and associated color-coded energy source tags
- Collaborating with your team during the process to provide the tools and knowledge necessary to sustain the program in-house

**Sustainability:** Looking for a turnkey solution? Brady Client Services also offers Procedure Auditing Services, Lockout Tagout training and our LINK360® procedure creation and management software to help you sustain and improve upon your progress.



## Confined Space Procedure Writing Service

To ensure safe employee entry, all confined spaces in your facility must have written permit procedures. Brady's qualified field engineers will come on-site and produce confined space entry procedures for each of your identified confined spaces, providing full compliance with OSHA, best safety practices and your internal written confined space program.

### While on-site, our field engineers will:

- Gather the necessary steps and information to properly identify and classify confined spaces
- Author all visual procedures within our LINK360® software or a format of our client's choosing
- Print, laminate and install the procedures
- Collaborate with your team during the process to provide the tools and knowledge necessary to sustain the program in-house

**Sustain Your Solution In-house:** Looking for a turnkey solution? Brady Client Services also offers Confined Space Training and our LINK360® procedure creation and management software to help you sustain and improve upon your progress.

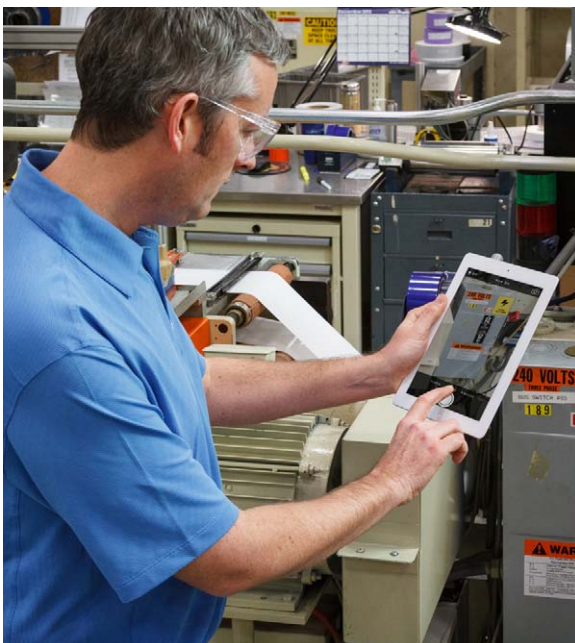

## Visual Workplace Audits

**A visual workplace is a safe workplace.** A visual workplace incorporates the proper signage, pipe marking and other visual directives, allowing employees to easily locate and understand their workplace environment. Brady's Visual Workplace Audits take a continuous improvement approach and provide you with a best-fit, realistic plan to improve your visual workplace. How do we do this? Once an audit is completed, our clients receive a detailed audit report that provides facility photos of areas for improvement, numbered pins showing points of install, and custom and stock product recommendations.

### Areas of audit focus can include:

- Personal Protection Equipment (PPE) Signage
- General Hazard Identification Signage
- Exit & Egress Signage
- Traffic Control Signage
- Confined Space Signage
- Electrical Hazard Signage

**Sustain Your Solution In-house:** Once the report is in our clients' hands, Brady offers the products and Visual Workplace Installation Services they need to make that plan a reality.



# Brady Client Services

BradyClientServices.com

Brady Client Services



## Safety Training and Seminars

**When it comes to workplace safety, there's no such thing as being too informed.** That's why Brady offers training solutions focused on your industry needs and what we do best: Hazcom / GHS, lockout tagout and confined spaces.

Brady Client Services offers a variety of continued education opportunities for your team, including instructor-led seminars and custom training programs. Each session is performed by a member of Brady's engagement team with experience in field-based environmental health and safety operations and more.

### Safety training and seminar topics include:

- Lockout Tagout for Authorized Employees
- Lockout Tagout for Affected Employees
- Hazcom / GHS

**Customizable for Your Safety Needs:** Require training, but don't see the topic you are interested in above? Contact us today to see how our expertise spans over a variety of compliance, safety and best practice topics.



## 5s+ Rapid Improvement Event

**Let Brady's lean implementation leader guide your team to help increase overall equipment effectiveness (OEE), productivity and more.** Brady's lean implementation leader comes to your facility to work alongside your employees where the work needs to happen – on the production floor. :

### Throughout the event, we work with your team to:

- Address your current areas of improvement
- Increase overall equipment effectiveness (OEE)
- Eliminate process variability
- Focus on your companies' key performance indicators (KPIs)
- Understand the role 5S+ plays in not only reaching, but exceeding your company goals and cost incentives

Once you complete the 3-day hands-on workshop, you will receive a sustainability and transition plan to ensure that you can continue to work towards the goals established in the event. In addition, our clients benefit from continued Brady support throughout their lean journey.

**Interested in a custom 5S+ Event?** Brady's lean implementation leader can customize events from 1-2 days to a week or longer.





## Visual Workplace Installation Services

**Our turnkey installation service allows you to focus on your everyday operations**, while we install the visually communicative tools necessary to keep your facility safe and compliant. We manage all projects and Paint Platoon USA™, a premier provider of painting, coating and marking services, serves your floor marking, painting and installation needs. Their installation experience, in conjunction with our visual workplace expertise, help you create your ideal visual workplace.

**We install the visual directives necessary to keep your facility safe including:**

- Safety Signage Installation
- Pipe Marking Installation
- Floor Marking and Painting
- Kaizen Painting



## Visual Workplace Production Services

**Hosting an internal Kaizen, 5S or Kanban event, or creating a model area or cell in your workplace? Let a Brady production specialist help.**

Each production specialist is an expert on labeling and signage, as well as industry requirements. We aid in your lean events by coming on-site with Brady printers and materials to guide your team, and create and print the labels your event requires. We set up your personal signage shop to help you standardize your visual controls.

At event completion, your model area will not only help you standardize the rest of the facility, but it will also guide you on multi-facility standardization.

**Standardization of visuals for:**

- Storage Locations
- Equipment Identification
- Line Identification
- Valves
- Gauge Ranges



**Contact a safety practitioner today to see how we can help you improve your visual workplace.**

**1-888-311-0774**

**BradyClientServices.com**



# Sign Legend Index

BradyID.com/s34

## Sign Legend Index

Legend Text	Header	Pg
Is Responsible For The Housekeeping In This Area	-	133
Volts	<b>Peligro</b>	52
Volts	<b>Danger</b>	40
Volts	<b>Danger</b>	90
Volts / Voltios	<b>Danger / Peligro</b>	52
Volts Authorized Personnel Only	<b>Danger</b>	88
\$100 Fine	-	172
\$200 Fine	-	172
\$250 Fine	-	172
\$350 Fine	-	172
1, 1, 1, Trichloroethane	-	78
1.5 Blasting Agents D 1	-	79
1.6 Explosive N 1	-	79
10 Min Parking Admission And Discharge Only	-	178
13,200 Volts	<b>Danger</b>	88
15 Minute Parking	-	178
2 Hr Parking Electric Vehicles Only	-	174
2 Hr Parking Electric Vehicles Only 7Am-8:30Pm	-	174
2 Hr Vehicle Charging Only	-	174
3 Causes Of Accidents I Didn't Think I Didn't See...	-	160
4 Causes Of Accidents I Didn't Think I Didn't See...	-	160
440 Voltios	<b>Peligro</b>	52
440 Volts	<b>Danger</b>	88
440 Volts / 440 Voltios	<b>Danger / Peligro</b>	52
45 Min Vehicle Charging Only 7 Am-10 Pm	-	174
45 Min Vehicle Charging Only 7 Am-10 Pm Mon-Fri	-	174
480 Volts	<b>Danger</b>	40

## A

A Careful Workman Is The Best Safety Device	<b>Be Careful</b>	165
A Careful Workman Is The Best Safety Device	<b>Safety First</b>	165
A Clean Place Is A Safe Place	-	133
A Clean Work Area Is A Safe Work Area	-	133
A Cluttered Area Is A Hazard Please Help Keep This ...	-	133
A Fire Today No Job Tomorrow	<b>Safety First</b>	165
A.E.D.	-	113
Access At Side	-	172
Accessible	-	159
Accidents Are Avoidable: Forget The Alibi	<b>Think</b>	165
Acetic Acid, Glacial	-	78
Acetone	-	78
Acetylene	-	78
Acetylene	<b>Caution</b>	64
Acetylene	<b>Danger</b>	66
Acetylene Empty Cylinders	-	74
Acetylene Flammable	<b>Danger</b>	40
Acetylene Flammable Gas No Smoking No Open Flames	-	74
Acetylene Full Cylinders	-	74
Acetylene No Smoking No Open Flames	-	74
Acid	<b>Caution</b>	64
Acid	<b>Danger</b>	66
Acid	<b>Warning</b>	73
Acid	<b>Danger</b>	66
Acid (W/ GHS Picto)	<b>Danger</b>	66
Acid / Acido	<b>Danger / Peligro</b>	52
Acid Contact Will Result In Serious Burns, Injury Or Death	<b>Danger</b>	40
Acid Could Result In Moderate Injury	<b>Caution</b>	36
Acid Keep Away	<b>Danger</b>	66
Acid Unloading Area Authorized Personnel Only	<b>Danger</b>	66
Acid Wear Proper Protection	<b>Danger</b>	66
Acid Wear Proper Protection	<b>Danger</b>	40
Acid Wear Protective Equipment	<b>Danger</b>	66
Acids	<b>Danger</b>	66
Acids Contact Will Result In Severe Burns, Injury Or Death	<b>Danger</b>	40
Acrylic Acid	-	78
Acrylonitrile (An) Cancer Hazard Authorized...	<b>Danger</b>	66
Acrylonitrile (An) May Cause Cancer Respiratory...	<b>Danger</b>	66
Additional Parking In Rear	-	178
Administration	-	116
Admittance Limited To Authorized Personnel	<b>Danger</b>	29
Admittance Only To Personnel Working In This Area	<b>Danger</b>	29
Aerosols	-	158
After Using Extinguisher Return To Storeroom For...	-	101
Agua No Potable	<b>Aviso</b>	56
Agua No Potable, No Apta Para Beber Ni Cocinar	<b>Aviso</b>	56
Airborne Radioactivity Area	-	157
Alarm Secured Door Emergency Exit Use Only	-	101
Alarm Will Sound If Door Opens	<b>Caution</b>	28
All Drums In This Area Must Be Grounded	<b>Notice</b>	72
All Employees And Visitors Must Wear Eye Protection	<b>Notice</b>	150

Legend Text	Header	Pg
All Employees And Visitors Must Wear Identification ...	<b>Notice</b>	167
All Employees Whose Work Does Not Require...	<b>Notice</b>	31
All Injuries No Matter How Slight They May Seem...	<b>Notice</b>	107
All Lunch Boxes, Packages, Bags, Purses, Etc Are...	<b>Notice</b>	31
All Personnel Must Wear Safety Glasses In The Plant	<b>Notice</b>	150
All Truck Drivers Must Sign In Before Proceeding...	<b>Notice</b>	31
All Unauthorized Vehicles Will Be Towed Away At...	-	168
All Vehicles And Personnel Entering Or Leaving The...	<b>Notice</b>	177
All Vehicles Entering Or Leaving Subject To Search	<b>Notice</b>	167
All Vehicles Entering Or Leaving The Premises Are...	<b>Notice</b>	31
All Visitors And Job Applicants Must Stop And...	<b>Notice</b>	31
All Visitors Must Get Pass At Office	<b>Notice</b>	31
All Visitors Must Get Pass At Office	<b>Restricted Area</b>	167
All Visitors Must Register At Office	<b>Notice</b>	31
All Visitors Must Report To Security	<b>Security Notice</b>	167
All Visitors Report To Site Office	<b>Notice</b>	170
All Way	-	178
Alternative Medicine	-	116
Alto Voltaje	<b>Peligro</b>	52
Alto Voltaje No Entrar	<b>Peligro</b>	52
Aluminum Cans Only	-	158
Always Add Acid To Water	<b>Caution</b>	40
Ambulance Entrance	-	116
Ambulance Parking Only	-	178
America And Safety First	-	160
America On Guard Be Alert	-	169
Ammonia	<b>Danger</b>	66
Ammonium Hydroxide	-	78
And Start A Trend Here	<b>Think</b>	112
Anesthesia	-	116
Anhydrous Ammonia	-	78
Anhydrous Ammonia	<b>Danger</b>	66
Anhydrous Ammonia Contact Will Result In Severe...	<b>Danger</b>	40
Antifreeze	<b>Danger</b>	66
Anyone Entering Tanks Must Wear Safety Belts	<b>Caution</b>	82
Anyone Working Over This Area Shall Wear A Safety...	<b>Caution</b>	82
Approach Door Slowly	<b>Caution</b>	28
Approach Slowly Gate Will Open	-	168
Arc Welding	<b>Caution</b>	36
Arc Welding	<b>Caution</b>	64
Area De Almacenamiento De Desechos Peligrosos...	<b>Peligro</b>	52
Area For Evacuation Assistance	-	101
Area For Rescue Assistance	-	101
Area In Front Of This Electrical Panel Must Be Kept...	<b>Caution</b>	36
Area In Front Of This Electrical Panel Must Be Kept...	<b>Danger</b>	40
Area In Front Of This Electrical Panel Must Be Kept...	-	90
Area In Front Of This Electrical Panel Must Be Kept...	<b>Caution</b>	88
Area In Front Of This Electrical Panel Must Be Kept...	<b>Caution / Precaucion</b>	50
Area In Front Of This Electrical Panel Must Be Kept...	<b>Danger</b>	88
Area In Front Of This Electrical Panel Must Be Kept...	<b>Danger / Peligro</b>	53
Area Of Refuge	-	101
Argon	<b>Danger</b>	66
Argon Be Back Later	<b>Danger</b>	112
Argon Empty Cylinders	-	74
Argon Full Cylinders	-	74
Arrow - 2 Way Traffic Symbol	-	178
Arrow Left	-	91
Arrow Pointing Right	-	178
Arrow Pointing Upper Right	-	178
Arrow Right	-	91
Arrow Right Down Picto	-	91
Arrow Right Up Picto	-	91
Arrow Symbol	-	111
Asbestos	-	158
Asbestos Cancer And Lung Disease Hazard Authorized...	<b>Danger</b>	66
Asbestos Cancer And Lung Disease Hazard Authorized...	<b>Danger</b>	170
Asbestos Cancer And Lung Disease Hazard Do Not...	<b>Caution</b>	64
Asbestos Cancer And Lung Disease Hazard. Authorized...	<b>Danger</b>	40
Asbestos Dust Hazard Avoid Breathing Dust...	<b>Caution</b>	64
Asbestos Dust Hazard Cancer And Lung Disease...	<b>Danger</b>	66
Asbestos Hazardous Do Not Disturb Without Proper...	<b>Caution</b>	36
Asbestos Hazardous Do Not Disturb Without Proper...	<b>Caution</b>	64
Asbestos May Cause Cancer Causes Damage To Lungs...	<b>Danger</b>	66
Asbestos Waste Disposal Site Do Not Create Dust...	<b>Caution</b>	64
Asbestos. Cancer And Lung Disease Hazard. Do Not...	<b>Caution</b>	36
Asbestos. May Cause Cancer And Lung Damage...	<b>Danger</b>	40
Assembly Picto	-	98
Assembly Point	-	98
Assembly Point	-	98
Assigned Parking Only	-	178
Atmosphere May Be Hazardous Follow Confined Space...	<b>Caution</b>	82

# Sign Legend Index

BradyID.com/s34

Legend Text	Header	Pg
Attach Grounding Cables	Caution	36
Attach Grounding Cables	Caution	88
Attach Grounding Wire Clips	Caution	88
Attention All Visitors And Sales People Please...	-	178
Authorized Drivers Only Are Allowed To Operate Lift Trucks	Notice	177
Authorized Employees Only	Restricted Area	32
Authorized Employees Only / Solo Empleados Autorizados	Restricted Area / Area Restringida	58
Authorized Parking Only	-	178
Authorized Personnel Only	-	33
Authorized Personnel Only	-	178
Authorized Personnel Only	Caution	28
Authorized Personnel Only	Danger	29
Authorized Personnel Only	Notice	31
Authorized Personnel Only	Warning	33
Authorized Personnel Only	Caution	36
Authorized Personnel Only	Danger	29
Authorized Personnel Only	Danger	40
Authorized Personnel Only	Notice	31
Authorized Personnel Only	Notice	48
Authorized Personnel Only	Restricted Area	167
Authorized Personnel Only	Warning	48
Authorized Personnel Only / Solo Personal Autorizado	Danger / Peligro	55
Authorized Personnel Only / Solo Personal Autorizado	No Trespassing / Prohibida La Entrada	56
Authorized Personnel Only / Solo Personal Autorizado	Notice / Aviso	57
Authorized Personnel Only Check With Control Room...	Danger	29
Authorized Personnel Only Entering Could Result...	Caution	36
Authorized Personnel Only Entering Could Result...	Danger	40
Authorized Personnel Only Entering Could Result...	Warning	48
Authorized Personnel Only Proper Id Required	Restricted Area	33
Authorized Personnel Only Proper Safety Attire...	-	33
Authorized Use Only	Danger	124
Authorized Vehicles Only	-	178
Automatic Door Keep Clear	-	87
Automatic Equipment May Start At Anytime	Caution	120
Automatic Equipment Will Start At Any Time	Caution	120
Automatic Equipment Will Start Without Warning	Caution	120
Automatic Security Alarm Will Sound When Door Is Opened	Notice	86
Automatic Sprinkler System Sub Basement	-	101
Automatic Start Equipment	Danger	124
Avoid A Fall Use Handrails	-	130
Avoid A Fall Use Handrails / Evite Caidas. Utilice El...	-	58
Avoid Accidents Clean Up Spills	-	133
Avoid Backtalk Please Lift Properly	-	160
Avoid Breathing Chemical Vapors Use Protective...	Caution	64
Avoid Contamination Wash Your Hands	Warning	142
Avoid Contamination Wash Your Hands	Notice	48
Avoid Injury Watch Your Step	Caution	36
Avoid Injury Watch Your Step	Caution	143
Ayude A Mantener Esta Area Limpia	-	58

## B

Back In Or Pull Out On Green Only	Warning	178
Back-In Parking Only	-	178
Bad Planning On Your Part Does Not Necessarily...	-	112
Barricade Area Do Not Enter Without Authorization Or ...	Danger	29
Basement Not An Exit	-	91
Battery Charging Area No Smoking	Danger	136
Battery Charging Area No Smoking	Warning	138
Battery Charging Station No Smoking Or Open Flames	Caution	176
Battery Charging Station No Smoking Or Open Flames...	Caution	36
Battery Room Absolutely No Smoking Safety Glasses ...	-	74
Be Alert Don't Get Hurt	-	166
Be Alert Moving Parts	Caution	120
Be Aware Of Moving Equipment	-	189
Be Aware Of Overhead Cranes	-	189
Be Aware Of Overhead Cranes And Avoid Suspended ...	-	189
Be Careful	Safety First	165
Be Careful Carelessness Can Hurt You And Others	-	160
Be Prepared To Stop	-	171
Be Safe Lock It Out	Caution	118
Be Sure Cylinder Is Properly Supported And Capped	Warning	48
Be Sure Elevator Is Locked When Loading Or Unloading	Caution	120
Be Sure Everyone Is Clear Before Starting Machine	Danger	124
Be Sure Safety Guards Work At All Times	Danger	124
Before Entering, Test For Explosive Atmosphere...	Caution	28
Before Working On Any Machine, Be Positive...	Be Careful	118
Before You Act	Think	165
Before You Leave Please Clean Up!	-	133
Before You Leave... Take A Minute To Clean	-	134
Benzaldehyde	-	78
Benzene	-	78
Benzene	Danger	66

Legend Text	Header	Pg
Benzene Cancer Hazard	Danger	66
Benzene Cancer Hazard Flammable-No Smoking...	Danger	66
Benzene Vapors	Caution	64
Beyond This Point You Are In The Presence Of...	Caution	36
Beyond This Point You Are In The Presence Of...	Caution	155
Bicycle Parking Only	-	179
Bike Lane	-	179
Billing Department	-	116
Bio Hazard / Riesgo Biologico	-	60
Bio Hazard / Riesgo Biologico	Danger / Peligro	55
Bio-Hazard Area	-	61
Biohazard	-	61
Biohazard	-	111
Biohazard Area	-	61
Biohazard Authorized Personnel Only	-	61
Biohazard Authorized Personnel Only	Warning	61
Biohazard Dispose Of Properly	-	61
Biohazard Infectious Agent Entry Requirements...	-	61
Biohazard Infectious Waste	-	61
Biohazard No Food Or Drink To Be Stored In This ...	-	61
Biohazard Universal PreCautions Must Be Observed	-	61
Biological Hazard Authorized Personnel Only	Caution	61
Blank Sign	-	2
Blank Sign	-	62
Blank Sign	-	175
Blank Sign	-	189
Blank Sign With Header Only	Area Restringida	62
Blank Sign With Header Only	Be Careful	62
Blank Sign With Header Only	Radiation	62
Blank Sign With Header Only	Restricted Area	62
Blank Sign With Header Only	Safety First	62
Blank Sign With Header Only	Advertencia	62
Blank Sign With Header Only	Aviso	62
Blank Sign With Header Only	Caution	62
Blank Sign With Header Only	Danger	62
Blank Sign With Header Only	Notice	62
Blank Sign With Header Only	Peligro	62
Blank Sign With Header Only	Precautacion	62
Blank Sign With Header Only	Warning	62
Blasting Keep Away	Danger	100
Blasting Keep Away	Warning	85
Blind Corner Proceed With Caution	-	179
Bloquear Los Manubrios Electricos Antes De Usar El ...	Peligro	52
Body Harness Required For Entry	Danger	148
Body Harness Required For Entry	Danger	40
Boiler Room Authorized Personnel Only	Danger	29
Books	-	158
Boots Must Be Worn	-	152
Boys	-	159
Braille Sign Frame	-	63
Breakers Locked Out	Danger	118
Breathing Air Emergency Use Only	Notice	107
Breathing Air Empty Cylinders	-	74
Breathing Air Full Cylinders	-	74
Breathing Air Station	Notice	107
Breathing Apparatus	-	113
Breathing Apparatus Keep Area Clear	Safety First	48
Breathing Apparatus Required	Caution	143
Bromine	-	78
Buckle Up And Drive Safely	-	179
Buckle Up It Could Save Your Life	-	179
Buckle Up! It's The Law	-	179
Buddy System Is Required For Entry	Caution	82
Buddy System Must Be Used For Entry Into Confined...	Danger	82
Building Materials	-	158
Bump	-	179
Bump Caps Must Be Worn In This Area	Caution	36
Bump Caps Must Be Worn In This Area	Caution	143
Buried Cable	Caution	88
Buried Cable	Danger	88
Buried Cable Call Before Digging _ _ _ _ _	Caution	88
Buried Cable. Proceed With Caution. Contact Will...	Danger	40
Buried Electric Line Below	Caution	88
Buried Gas Line	Caution	85
Buried Pipeline	Caution	64
Butane	-	78
Butanol	-	78

## C

Cable Buried Here	Danger	89
Cable Buried Here. Contact Will Result In...	Danger	40
Cadmium Cancer Hazard Can Cause Lead And Kidney...	Danger	66
Cadmium May Cause Cancer Causes Damage To...	Danger	66



# Sign Legend Index

BradyID.com/s34

Legend Text	Header	Pg
Calcium Chloride	-	78
Calcium Hypochlorite	-	78
Caliente	<b>Peligro</b>	53
California Proposition 65 Warning Diesel Engine...	-	74
Cameras Not Allowed	-	168
Cancer Hazard Authorized Personnel Only No Smoking ...	<b>Danger</b>	67
Cancer Suspect Agent Area Protective Equipment...	-	74
Capacity ___ Lbs / Capacidad: ___ Kg	<b>Caution / Precaucion</b>	50
Capacity ___ Lbs	<b>Caution</b>	132
Capacity Tons	-	134
Car Pool Parking Only	-	179
Carbon Dioxide	-	78
Carbon Dioxide	<b>Danger</b>	67
Carbon Disulfide	-	78
Carbon Monoxide Area Requires Proper Ventilation	<b>Caution</b>	64
Carbon Monoxide May Be Present	<b>Caution</b>	64
Carbon Monoxide May Be Present	<b>Danger</b>	67
Carbon Monoxide May Be Present Wear Necessary...	<b>Caution</b>	36
Carbon Monoxide May Be Present Wear Necessary...	<b>Danger</b>	40
Carbon Tetrachloride	-	78
Cardboard Only	-	158
Cardiology	-	116
Cardiology Parking Only	-	179
Care Staff Area	-	116
Carry It Low - Drive It Slow	-	160
Carrying Concealed Deadly Weapons Is Prohibited...	-	33
Cartons	-	158
Cat Scan	-	116
Cath Lab	-	116
Causes Of Accidents: 1 I Didn't Think 2 I Didn't...	-	166
Caustic	<b>Danger</b>	67
Caustic Chemical Goggles Must Be Worn In This Area	<b>Caution</b>	64
Caustic In Use Wear Protective Equipment	<b>Danger</b>	67
Caustic Overhead	<b>Danger</b>	67
Caustic Potash (Potassium Hydroxide)	-	78
Caustic Soda (Sodium Hydroxide)	-	78
Caustic Soda Avoid Skin Or Eye Contact Avoid...	<b>Caution</b>	64
Caustic Unloading Area Authorized Personnel Only	<b>Danger</b>	67
Caustic Wear Protective Equipment	<b>Danger</b>	67
Caustic Will Cause Severe Burns, Injury Or Death.	<b>Danger</b>	40
Caustic. Will Cause Severe Burns, Injury Or Death...	<b>Danger</b>	40
Caution	-	130
Caution - Propane	-	74
Caution (3 Pocket With Grommets)	-	156
Caution (5 Pocket With Grommets)	-	156
Caution Automatic Door	-	87
Caution Biohazard	-	61
Caution Biological Hazard	-	61
Caution Children At Play	-	179
Caution Door Swings Out	-	113
Caution Drive Slowly	-	179
Caution Eye Protection Required In This Area	-	113
Caution High Level Radio Frequency Energy Area...	-	156
Caution High Radiation Area	-	156
Caution Laser Invisible Beam	-	156
Caution Radiation Area	-	110
Caution Radiation Area	-	156
Caution Radiation Area Authorized Entry Only	-	156
Caution Radiation Area Keep Out	-	156
Caution Radiation Area Radioactive Materials...	-	156
Caution Radioactive Material	-	156
Caution Radioactive Materials	-	156
Caution Slippery Surface	-	49
Caution Speed Bump	-	179
Caution This Equipment Produces Ionizing Radiation...	-	156
Caution Wet Floor	-	49
Caution X-Rays This Equipment Produces X-Rays When...	-	156
Caution! Automatic Gates No Playing Or Climbing...	-	179
Chain All Cylinders Securely	<b>Notice</b>	72
Changeable Arrow	-	101
Chapel	-	116
Check Battery Acid Before Connecting Charger	<b>Caution</b>	64
Chemical Goggles Must Be Worn Beyond This Point	<b>Notice</b>	150
Chemical Goggles Required	-	74
Chemical Goggles Required In This Area	<b>Caution</b>	143
Chemical Goggles Required In This Area	<b>Caution</b>	36
Chemical Lines Overhead	<b>Caution</b>	64
Chemical Spillage Must Be Reported Immediately...	-	74
Chemical Spills Must Be Reported Immediately	<b>Notice</b>	72
Chemical Storage	-	111
Chemical Storage	<b>Danger</b>	41
Chemical Storage	<b>Danger</b>	67
Chemical Storage	<b>Danger</b>	67
Chemical Storage / Almacenamiento De Sustancias ...	<b>Danger / Peligro</b>	52

Legend Text	Header	Pg
Chemical Storage Area	<b>Warning</b>	73
Chemical Storage Area	-	110
Chemical Storage Area / Area Para Almacenamiento...	<b>Caution / Precaucion</b>	50
Chemical Waste Storage Area Unauthorized Persons ...	<b>Danger</b>	29
Chlorine	-	78
Chlorine	<b>Danger</b>	67
Chlorine / Cloro	<b>Danger / Peligro</b>	53
Chlorine Area	<b>Caution</b>	64
Chlorine Area. Hazardous Contact May Result In Injury.	<b>Caution</b>	36
Chlorine Gas	<b>Danger</b>	67
Chlorine Gas. Breathing Gas Will Result In Severe...	<b>Danger</b>	41
Chlorine. Contact Will Cause Burns Or Severe Injury.	<b>Danger</b>	41
Chloroform	-	78
Chromic Acid, Solid Chromium Anhydride	-	78
Church Parking Only	-	179
Clean And Store Respirator After Use	<b>Notice</b>	150
Clean Empty Drums	-	74
Clean Equipment After Use	<b>Notice</b>	128
Clean Machine At The End Of Each Shift	<b>Notice</b>	128
Clean Up After Your Dog Dog Waste Transmits Disease	-	158
Clean Up And Keep Clean	-	134
Clearance ___ Ft ___ In	<b>Caution</b>	36
Clearance ___ Ft ___ In	<b>Caution</b>	120
Clearance ___ Ft	<b>Notice</b>	128
Clearance Ft In	<b>Caution</b>	36
Clearance Ft In	<b>Caution</b>	120
Climb Ladders Slowly And Use Both Hands	<b>Safety First</b>	129
Close Clearance	<b>Caution</b>	176
Close Clearance	<b>Danger</b>	124
Close Door When Not In Use	<b>Caution</b>	86
Closed Area Authorized Personnel Only	-	33
Clothing Contaminated With Lead	<b>Caution</b>	64
Coke Oven Emissions May Cause Cancer Do Not...	<b>Danger</b>	67
Combustible	<b>Danger</b>	67
Combustible 3	-	80
Combustible Diesel	<b>Peligro</b>	53
Combustible Dust	<b>Warning</b>	73
Combustible Dust Area No Smoking Or Open Flame	<b>Danger</b>	136
Combustible Dust No Smoking, Welding Or Compressed...	<b>Danger</b>	136
Combustible Liquids	<b>Danger</b>	67
Combustible Liquids	<b>Danger</b>	41
Combustible Liquids (W/ GHS Picto)	<b>Danger</b>	67
Compact Cars Only	<b>Notice</b>	177
Company Is Not Responsible For Loss Or Damage To ...	<b>Notice</b>	177
Company Phones Are For Business Only No Personal ...	-	130
Complaint Department 100 Miles	<b>Notice</b>	112
Compressed Air	<b>Caution</b>	64
Compressed Air	<b>Danger</b>	67
Compressed Air Do Not Use For Blowing Off Clothes	<b>Danger</b>	41
Compressed Air Do Not Use For Blowing Off Clothes	<b>Danger</b>	67
Compressed Air Do Not Use For Cleaning	<b>Danger</b>	67
Compressed Air Lock Out Source And Bleed Off...	<b>Warning</b>	119
Compressed Air. Improper Release Could Result In Injury	<b>Caution</b>	36
Compressed Gas	<b>Danger</b>	67
Confined Space Permit Required Unauthorized Entry ...	<b>Danger</b>	84
Confined Space	<b>Danger</b>	82
Confined Space	<b>Danger</b>	41
Confined Space	<b>Danger</b>	82
Confined Space Air-Supplied Respirator Required	<b>Danger</b>	82
Confined Space Authorized Personnel Only	<b>Danger</b>	41
Confined Space Authorized Personnel Only	<b>Danger</b>	41
Confined Space Call _____ Before Attempting...	<b>Danger</b>	82
Confined Space Call Your Supervisor	<b>Danger</b>	84
Confined Space Class ___ Permit Required For Entry	<b>Caution</b>	82
Confined Space Class ___ Permit Required For...	<b>Caution</b>	82
Confined Space Do Not Enter Without Obtaining Permit	<b>Caution</b>	82
Confined Space Do Not Enter Without Obtaining Permit	<b>Caution</b>	84
Confined Space Do Not Enter Without Permit And...	<b>Danger</b>	82
Confined Space Do Not Enter Without Proper Protective ...	<b>Danger</b>	82
Confined Space Enter All Tanks By Permit Only	<b>Danger</b>	82
Confined Space Enter By Permit Only	<b>Caution</b>	82
Confined Space Enter By Permit Only	<b>Danger</b>	70
Confined Space Enter By Permit Only	<b>Danger</b>	83
Confined Space Enter By Permit Only	<b>Danger</b>	84
Confined Space Enter By Permit Only	<b>Danger</b>	41
Confined Space Enter By Permit Only	<b>Danger</b>	83
Confined Space Enter By Permit Only / Area...	<b>Danger / Peligro</b>	52
Confined Space Enter By Permit Only Prepare For...	<b>Danger</b>	83
Confined Space Entering Without Training Will...	<b>Danger</b>	41
Confined Space Entry Can Be Fatal Entry By Permit Only	<b>Danger</b>	83
Confined Space Entry Can Be Fatal Follow All...	<b>Danger</b>	84
Confined Space Entry Permit Required # _____	<b>Danger</b>	83
Confined Space Entry Permit Required Call Your Supervisor	<b>Caution</b>	82
Confined Space Entry Permit Required Call Your Supervisor	<b>Danger</b>	84

# Sign Legend Index

BradyID.com/s34

Legend Text	Header	Pg
Confined Space Follow Entry Procedures #	Danger	83
Confined Space Hazardous Atmosphere Air-Supplied...	Danger	29
Confined Space Hazardous Atmosphere Air-Supplied...	Danger	83
Confined Space Hazardous Atmosphere Check...	Danger	70
Confined Space Hazardous Atmosphere Check...	Danger	83
Confined Space Hazardous Atmosphere Entry By ...	Danger	29
Confined Space Hazardous Atmosphere Entry By ...	Danger	83
Confined Space Keep Out	Danger	83
Confined Space Keep Out Unless Authorized	Danger	41
Confined Space Keep Out Unless Authorized	Danger	83
Confined Space Keep Out Unless Authorized / Espacio...	Danger / Peligro	53
Confined Space Lock Out And Tag Out Required Before...	Danger	41
Confined Space Lock Out And Tag Out Required Before...	Danger	83
Confined Space Lock-Out & Tag-Out Procedures...	Danger	83
Confined Space No Smoking, Matches Or Open Lights	Danger	83
Confined Space No ___ Entry Permit Required Call...	Caution	28
Confined Space Permit Not Required	Danger	84
Confined Space Permit Required	Danger	84
Confined Space Permit Required For Entry	Danger	84
Confined Space Procedures Must Be Followed	Caution	82
Confined Space Trained Personnel Only	Caution	82
Confined Space Use Lockout And Entry Procedures...	Caution	82
Confined Space Use Lockout And Entry Procedures...	Caution / Precaucion	50
Confined Space Ventilate Before Entering	Danger	84
Confined Space, Enter By Permit Only, Prepare For...	Danger	41
Connect Ground Wire Before Using	Caution	88
Conserve Water	-	158
Construction Ahead	-	171
Construction Area	Danger	85
Construction Area / Area De Construccion	Danger / Peligro	52
Construction Area Authorized Personnel Only	Caution	28
Construction Area Authorized Personnel Only Hard...	-	85
Construction Area Keep Out	Danger	29
Construction Area Keep Out	Danger	41
Construction Area Keep Out / Area De Construccion...	Danger / Peligro	52
Construction Area Keep Out Entering Could Result...	Danger	41
Construction Entrance	-	85
Construction In Progress	Caution	85
Construction Parking	-	170
Construction Personnel Only	Danger	85
Construction Site Keep Out	Danger	170
Construction Site No Trespassing	Danger	170
Construction Site No Trespassing	Notice	31
Construction Site Unauthorized Persons Keep Out	Danger	170
Construction Worker Picto	-	171
Construction Zone Unauthorized Personnel Keep Out	Danger	177
Construction Zone Unauthorized Personnel Keep Out...	Danger	41
Contains Asbestos Fibers Avoid Creating Dust	Danger	41
Contains Asbestos Fibers Avoid Creating Dust-Cancer...	Danger	67
Contains Asbestos Fibers Avoid Creating Dust-Cancer...	Danger / Peligro	53
Contains Asbestos Fibers, Avoid Creating Dust...	Danger	41
Contains Benzene Cancer Hazard	Caution	64
Contains Cadmium Poisonous Fumes May Be Formed ...	Warning	73
Contains Ethylene Oxide Cancer Hazard And ...	Danger	67
Contains Fluorides	Caution	64
Contains Hazardous Material See Msds File	Caution	64
Contaminated Water	Danger	67
Contamination In System	-	157
Contents Under Extreme Pressure Handle With Care	Danger	67
Contractor Parking	-	179
Control Room	-	87
Controlled Access Zone	Danger	29
Conveyor May Start Without Warning	Caution	120
Conveyor May Start Without Warning / La Banda...	Caution / Precaucion	50
Cooked Meat Only	-	130
Corrosive	Danger	67
Corrosive	-	74
Corrosive	Danger	67
Corrosive 8	-	80
Corrosive Contact Will Cause Burns Or Severe Injury	Danger	41
Corrosive Liquids Wear Acid Gloves And Goggles	Danger	67
Corrosive Liquids Wear Protective Equipment	Danger	67
Corrosive Materials (W/ GHS Picto)	Danger	67
Corrosive Materials Wear Protective Clothing	Warning	73
Corrosive Materials Wear Required Protection	Caution	64
Corrosive Materials Wear Required Protection	Caution	36
Corrosive Materials Wear Required Protection...	Caution / Precaucion	50
Corrosive Picto (W/ Blank Box) 8	-	80
Corrosives Avoid Contact With Eyes And Skin	Danger	41
Cotton Dust Causes Damage To Lungs (Byssinosis)...	Danger	67
Cotton Dust Work Area May Cause Acute Or Delayed...	Warning	73
Cpr Station	-	113
Crane Overhead	Danger	124
Crane Overhead / Grúa Aerea	Danger / Peligro	54

Legend Text	Header	Pg
Crane Overhead Proceed With Caution	Danger	41
Crane Swing	Danger	124
Crane Working Overhead	Danger	124
Cross On Green Light Only	-	179
Cross Only At Cross Walks	-	179
Crossing Or Standing On Conveyor Is Forbidden	Danger	124
CT	-	116
Cuidado Con La Salida De Camiones	Precaucion	50
Customer Parking	-	179
Customer Parking Unauthorized Cars Will Be Towed...	-	179
Customer Pick-Up	-	179
Customers Not Permitted In Working Area	Notice	31
Cut / Sever	-	130
Cutting And Welding Permit Required In This Area	Caution	120
Cyanide	Danger	67
Cylinder Storage Area	-	74
Cylinders Contain Explosive Gas Handle With Care	Danger	68
Cylinders Must Be Secured	Danger	68
Cylinders Not Connected Must Be Capped	Notice	72

## D

Damaging Or Defacing Company Property Will Result...	-	168
Danger Automatically Controlled May Start At Any Time	-	130
Danger High Radiation Area Authorized Personnel Only	-	157
Danger High Voltage	-	90
Danger High Voltage Cable Buried Here	-	90
Danger Hot	-	49
Danger Laser Light	-	157
Danger Moving Machinery	-	130
Danger No Trespassing Positively No Admittance	-	33
Danger-Acids Wear Goggles Avoid Fumes And Skin...	-	74
Danger-Acids Wear Goggles Avoid Fumes And Skin...	-	75
Danger-Acids Wear Goggles Avoid Fumes And Skin...	-	152
Dangerous	-	80
Dangerous When Wet 4	-	80
Debe Haber Un Espacio De 1M Delante De Este...	Peligro	53
Debe Haber Un Espacio De 1M Delante De Este...	Precaucion	50
Deep Excavation	Danger	170
Deliveries In Rear	-	179
Demolition Work In Progress	Danger	170
Dental	-	116
Deposit All Rubbish In Receptacles Provided	Please	133
Deposit Matches And All Smoking Material Here	-	138
Deposit Waste Here	Notice	132
Derail	-	175
Dermatology	-	116
Designated Smoking Area	-	138
Designated Smoking Area	Notice	137
Designated Smoking Eating & Drinking Area	-	138
Designated Smoking Room	-	138
Designated Work Area Select Carcinogens Reproductive...	Caution	64
Detectable Amounts Of Chemicals Known To The State...	Warning	48
Detectable Amounts Of Chemicals Known To The State...	Warning	73
Detour Ahead	-	171
Diabetes Education	-	116
Diagonal Parking	-	179
Dial 911 In Case Of Emergency	Safety First	107
Did You Remember To Remove Your Locks And Tags	-	119
Did You Wash Them? Hand Washing Stops The ...	-	142
Diesel	Danger	68
Diesel Flammable	Danger	41
Diesel Fuel	-	78
Diesel Fuel	Danger	68
Diesel Fuel / Gasoleo	Danger / Peligro	54
Diesel Fuel Flammable	Danger	41
Diesel Fuel No Smoking In This Area	-	138
Diesel Fuel No Smoking No Open Flames	Danger	68
Diesel Fuel No Smoking No Open Flames / Combustible...	Danger / Peligro	53
Diesel Fuel No Smoking No Open Flames Will...	Danger	41
Diesel No Smoking	Danger	41
Diesel No Smoking	Danger	136
Diesel Only	-	75
Disconnect Power Supplies And Lock Out Before Servicing	Caution	118
Do It Right The First Time! Plan Ahead	Think	112
Do Not Alter Or Move Scaffold While In Use	Danger	85
Do Not Attempt To Adjust Machinery While In Motion	Caution	120
Do Not Block	-	179
Do Not Block Door	Notice	86
Do Not Block Door	Warning	86
Do Not Block Door / No Obstruir La Puerta	Notice / Aviso	57
Do Not Block Doorway	-	87
Do Not Block Driveway 24 Hour Access Required	-	179
Do Not Block Keep Clear At All Times	-	87



# Sign Legend Index

BradyID.com/s34

Legend Text	Header	Pg
Do Not Climb On Or Jump Off Dock	-	179
Do Not Climb Over This Enclosure Contains High...	<b>Danger</b>	89
Do Not Deposit Sanitary Napkins In Toilet Bowls...	<b>Notice</b>	132
Do Not Discard Trash Of Any Kind In Toilet Use ...	-	159
Do Not Discard Trash Of Any Kind In Toilet Use...	-	59
Do Not Drink The Water	<b>Warning</b>	73
Do Not Drink This Water	<b>Danger</b>	68
Do Not Drink This Water / No Beber Esta Agua	<b>Danger / Peligro</b>	54
Do Not Drive On Tracks	-	179
Do Not Dump Chemicals Down This Drain	<b>Notice</b>	72
Do Not Dump Chemicals Solvents Or Oils Down Drains	<b>Warning</b>	73
Do Not Enter	-	33
Do Not Enter	-	110
Do Not Enter	-	111
Do Not Enter	-	168
Do Not Enter	-	179
Do Not Enter	<b>Caution</b>	28
Do Not Enter	<b>Caution</b>	36
Do Not Enter	<b>Danger</b>	29
Do Not Enter	<b>Danger</b>	41
Do Not Enter	<b>Danger</b>	170
Do Not Enter	<b>Restricted Area</b>	167
Do Not Enter	<b>Warning</b>	33
Do Not Enter	<b>Warning</b>	48
Do Not Enter	<b>Caution</b>	36
Do Not Enter	<b>Caution</b>	86
Do Not Enter	<b>Danger</b>	29
Do Not Enter	<b>Notice</b>	31
Do Not Enter / No Entrar	<b>Caution / Precaucion</b>	51
Do Not Enter / No Entrar	<b>Danger / Peligro</b>	54
Do Not Enter / Out	-	87
Do Not Enter Area Unless Wearing Proper Safety...	<b>Notice</b>	150
Do Not Enter Authorized Personnel Only	<b>Danger</b>	29
Do Not Enter Authorized Personnel Only	<b>Danger</b>	41
Do Not Enter Authorized Personnel Only	<b>Warning</b>	33
Do Not Enter Authorized Personnel Only	<b>Restricted Area</b>	167
Do Not Enter Authorized Personnel Only / No Entrar...	<b>Danger / Peligro</b>	55
Do Not Enter Chemicals In Use	<b>Danger</b>	68
Do Not Enter Emergency Exit Only	<b>Danger</b>	29
Do Not Enter Emergency Exit Only	<b>Danger</b>	91
Do Not Enter Hazardous Area Authorized Persons Only	<b>Danger</b>	68
Do Not Enter Test In Progress	<b>Danger</b>	29
Do Not Enter Truck Or Trailer With Forklift Until...	<b>Danger</b>	177
Do Not Enter Unless Wearing Safety Equipment	<b>Safety First</b>	33
Do Not Enter Unless Wheels Are Chocked	<b>Be Careful</b>	176
Do Not Enter Until Lockout Procedures Are Complete	<b>Danger</b>	118
Do Not Enter Until Lockout Procedures Are Complete...	<b>Danger</b>	41
Do Not Enter When Equipment Is Operating	<b>Danger</b>	29
Do Not Enter When Equipment Is Operating / No...	<b>Danger / Peligro</b>	55
Do Not Enter When Light Is On	<b>Caution</b>	28
Do Not Enter When Lights Are Flashing	<b>Danger</b>	29
Do Not Enter When Red Light Is On	<b>Danger</b>	29
Do Not Enter While Machinery In Motion	<b>Caution</b>	28
Do Not Enter While Machinery In Motion May Cause...	<b>Caution</b>	36
Do Not Enter Without A Confined Space Permit	<b>Caution</b>	28
Do Not Enter Without A Confined Space Permit	<b>Caution</b>	36
Do Not Enter Without Wearing Ear Protection	<b>Danger</b>	29
Do Not Enter Without Wearing Ear Protection	<b>Danger</b>	148
Do Not Enter Without Wearing Ear Protection Severe...	<b>Danger</b>	42
Do Not Enter Without Wearing Eye And Ear Protection	<b>Caution</b>	28
Do Not Enter Without Wearing Eye Protection	<b>Caution</b>	143
Do Not Enter Without Wearing Eye Protection Vision...	<b>Caution</b>	37
Do Not Enter Without Wearing Hard Hat	<b>Danger</b>	148
Do Not Enter Without Wearing Hard Hat Accident Will...	<b>Danger</b>	42
Do Not Enter Without Wearing Protective Clothing	<b>Danger</b>	29
Do Not Enter Without Wearing Safety Glasses	<b>Danger</b>	148
Do Not Enter Without Wearing Safety Glasses Accident...	<b>Danger</b>	42
Do Not Enter. Permit-Required Confined Space.	<b>Danger</b>	42
Do Not Exit / Enter	-	87
Do Not Handle Without Wearing Safety Shield Accident...	<b>Danger</b>	42
Do Not Handle Without Wearing Safety Shield Or...	<b>Danger</b>	148
Do Not Leave Machine Unattended	<b>Notice</b>	128
Do Not Litter Place All Refuse In Trash Receptacles	-	134
Do Not Litter Please Use Containers Provided	-	134
Do Not Litter! Please Put Cigarette Butts In...	-	158
Do Not Look At Electric Arc It Will Hurt Your Eyes	<b>Danger</b>	148
Do Not Look At Electric Arc It Will Hurt Your Eyes...	<b>Danger</b>	42
Do Not Obstruct Fire Apparatus	-	101
Do Not Oil Or Clean Machinery While In Motion	<b>Safety First</b>	129
Do Not Open Alarm Will Sound	<b>Caution</b>	28
Do Not Open Door Alarm Will Sound	-	101
Do Not Open This Door	<b>Danger</b>	86
Do Not Operate	<b>Danger</b>	118
Do Not Operate Activation Will Result In Severe...	<b>Danger</b>	42

Legend Text	Header	Pg
Do Not Operate Closer Than 20 Feet To Power Lines	<b>Danger</b>	124
Do Not Operate Controls While This Sign Is In Place	<b>Danger</b>	124
Do Not Operate Machine Under Repair	<b>Caution</b>	120
Do Not Operate Machine Without Guards In Place	<b>Warning</b>	129
Do Not Operate Man Working On Repairs	<b>Caution</b>	120
Do Not Operate Men Working On Repairs	<b>Danger</b>	124
Do Not Operate This Equipment Without Ear Protection	<b>Notice</b>	150
Do Not Operate This Machine Without Guards In...	<b>Caution</b>	37
Do Not Operate This Machine Without Guards In Place	<b>Caution</b>	120
Do Not Operate When Wearing Gloves Or Loose Clothing	-	130
Do Not Operate When Wearing Gloves Or Loose Clothing	<b>Caution</b>	120
Do Not Operate Without Eye Protection	-	152
Do Not Operate Without Eye Protection	<b>Caution</b>	143
Do Not Operate Without Eye Protection May Cause ...	<b>Caution</b>	37
Do Not Operate Without Guards	-	130
Do Not Operate Without Guards	<b>Caution</b>	120
Do Not Operate Without Guards	<b>Caution</b>	37
Do Not Operate Without Guards In Place	<b>Danger</b>	42
Do Not Operate Without Guards In Place	<b>Danger</b>	124
Do Not Operate Without Guards In Place / No Operar...	<b>Danger / Peligro</b>	55
Do Not Operate Without Guards In Place Death Or...	<b>Danger</b>	42
Do Not Operate Without Guards Machines. May...	<b>Caution</b>	37
Do Not Operate Without Wearing Goggles	<b>Danger</b>	148
Do Not Operate Without Wearing Goggles Accident...	<b>Danger</b>	42
Do Not Park Here	<b>Notice</b>	177
Do Not Park In Driveway	<b>Notice</b>	177
Do Not Park In Front Of Door	-	180
Do Not Park In Front Of Door	<b>Notice</b>	86
Do Not Park In Front Of Dumpster	-	180
Do Not Pass	-	180
Do Not Perform A Confined Space Rescue Without...	<b>Danger</b>	84
Do Not Play On Or Around	<b>Caution</b>	120
Do Not Pour Chemicals Down The Drain	<b>Caution</b>	65
Do Not Put Hands Or Fingers Into Or Under Cutting Dies	<b>Danger</b>	124
Do Not Put On Or Take Off Belts While Machinery Is ...	<b>Safety First</b>	129
Do Not Put Your Hands In This Press Under Any Conditions	<b>Caution</b>	120
Do Not Raise Gate Until The Elevator Has Stopped...	<b>Danger</b>	124
Do Not Reach Into Running Equipment	<b>Caution</b>	120
Do Not Remove Guards Or Operate Machinery Without...	<b>Warning</b>	49
Do Not Remove Guards Or Operate Machinery Without ...	<b>Warning</b>	129
Do Not Ride On The Elevator It Is For Freight Only	<b>Notice</b>	128
Do Not Ride This Vehicle	<b>Danger</b>	124
Do Not Scatter Paper And Trash On Floors This Is...	<b>Think</b>	133
Do Not Smoke Eat Or Drink In This Area	<b>Caution</b>	136
Do Not Smoke In This Area	<b>Notice</b>	48
Do Not Smoke, Eat Or Drink In This Area	<b>Notice</b>	48
Do Not Stack To Within 18 Of Sprinkler Pipes	-	101
Do Not Stand Here	<b>Danger</b>	124
Do Not Stand In Front Of Machine While Operating	<b>Danger</b>	124
Do Not Start	<b>Caution</b>	118
Do Not Start Engine	<b>Danger</b>	124
Do Not Start Machine Being Repaired	<b>Danger</b>	124
Do Not Start Machine Being Repaired / No Encender...	<b>Danger / Peligro</b>	54
Do Not Start This Machine	<b>Danger</b>	124
Do Not Start This Machine	<b>Warning</b>	129
Do Not Stop On Tracks	-	180
Do Not Talk To Operator	<b>Caution</b>	120
Do Not Talk To Operator	<b>Notice</b>	128
Do Not Talk To Operator While Machine Is In Operation	<b>Danger</b>	124
Do Not Talk To Operators To Distract Their Attention...	<b>Safety First</b>	129
Do Not Throw Any Rubbish Or Waste In Toilet	<b>Notice</b>	132
Do Not Throw Paper Towels In Toilet	<b>Please</b>	133
Do Not Touch Out Of Order	<b>Danger</b>	125
Do Not Touch Switches	<b>Danger</b>	89
Do Not Unload Without Full Protective Gear	<b>Danger</b>	148
Do Not Use	<b>Danger</b>	125
Do Not Use Hands To Clean This Machine	<b>Danger</b>	125
Do Not Use On Electrical Fires	<b>Caution</b>	88
Do Not Use This Equipment	<b>Warning</b>	129
Do Not Use Water On Fires In This Area	-	101
Do Not Walk On Conveyors	<b>Caution</b>	143
Do Not Walk On Conveyors. Fall Will Result In Injury.	<b>Caution</b>	37
Do Not Watch Arc	<b>Caution</b>	88
Do Not Watch Arc	<b>Caution</b>	143
Do Not Watch Arc Vision Damage May Occur.	<b>Caution</b>	37
Do Not Watch Arc Welder At Work The Light May Blind You	<b>Danger</b>	42
Do Not Watch Arc Welder At Work The Light May Blind You	<b>Danger</b>	148
Do Not Watch Arc Welder At Work The Light Will Blind You	<b>Danger</b>	125
Do Not Watch The Arc	<b>Danger</b>	125
Do Not Watch The Arc. Severe Vision Damage Will Result.	<b>Danger</b>	42
Do Not Wear Gloves While Operating This Equipment	<b>Caution</b>	37
Do Not Wear Gloves While Operating This Equipment	<b>Caution</b>	143
Do Not Wear Jewelry, Loose Clothing Or Long Hair...	<b>Caution</b>	120
Do Not Wear Loose Clothing While Operating This ...	<b>Caution</b>	120

# Sign Legend Index

BradyID.com/s34

Legend Text	Header	Pg
Do You Want To Talk To The One In Charge Or ...	Notice	112
Dog Waste Transmits Disease Contaminates Drinking...	-	158
Don't Clean Or Repair Machinery While In Motion	Danger	125
Don't Forget Lock Out Tag Out	-	160
Don't Have An Accident	-	160
Don't Start Out Of Order	Danger	125
Don't Take Chances Others Are Depending On You	Think	165
Don't Try To Lift More Than You Are Able	Safety First	165
Don't Be A Litterbug Use Receptacles	-	134
Don't Even Think About Smoking In This Area	-	138
Don't Even Think Of Parking Here	-	180
Don't Pass It Up...Pick It Up!	-	134
Door Alarmed Open Only For Emergency Exit	Notice	86
Door For Emergency Use Only	Notice	86
Door Opens Outward	Caution	28
Door Swings Inward	Caution	86
Dose Rate At This Point Is ___ Mr/Hr Date Posted...	-	157
Dose Rate ___Mr/Hr ___Special Instructions...	-	157
Double Hearing Protection Required In This Area	Caution	143
Double Hearing Protection Required In This Area...	Caution	37
Double-Headed Arrow Pointing Left And Right	-	180
Down Time Is Clean Up Time	-	134
Drinking Water	Notice	132
Drive Slowly	Danger	177
Drive Slowly Accident Will Result In Severe Injury...	Danger	42
Drivers Chock Both Wheels	-	180
Drivers Chock Wheels And Turn Off Engine...Etc	-	180
Drivers Must Report Inside	-	33
Drivers Restricted To Truck Loading Dock Only No ...	Notice	177
Drum Storage Rules All Drums Must Be Securely...	-	75
Drums Must Be Labeled	Notice	72
Ducha De Emergencia Y Para Lavado De Ojos	-	58
Dust Mask Is Required	Caution	143
Dust Mask Is Required Breathing Unfiltered Air...	Caution	37
Dust Masks Are Required At All Times	-	188
Dust Masks Are Required In This Area	-	188
Dust Respirator Must Be Worn On This Job	Notice	150

## E

Ear And Eye Protection Area	Caution	143
Ear And Eye Protection Area Failure May Result In...	Caution	37
Ear Hazard Area Ear Protection Required At All Times	Caution	144
Ear Hazard Area Ear Protection Required At All Times	Caution	37
Ear Plugs Must Be Worn In This Area	Caution	144
Ear Plugs Must Be Worn In This Area Failure May...	Caution	37
Ear Protection Area	-	111
Ear Protection Area	-	110
Ear Protection Area	Danger	148
Ear Protection Area / Area De Proteccion Para Los Oidos	Danger / Peligro	52
Ear Protection Area Severe Hearing Damage Will Result.	Danger	42
Ear Protection Is Available See Your Supervisor	Safety First	151
Ear Protection Must Be Worn	-	152
Ear Protection Must Be Worn Beyond This Point	Notice	150
Ear Protection Must Be Worn In This Area	Caution	144
Ear Protection Must Be Worn In This Area	Danger	148
Ear Protection Must Be Worn In This Area	-	152
Ear Protection Must Be Worn In This Area / En Esta...	Notice / Aviso	56
Ear Protection Must Be Worn In This Area Moderate...	Caution	37
Ear Protection Must Be Worn In This Area Serious...	Danger	42
Ear Protection Must Be Worn In This Plant	Caution	144
Ear Protection Must Be Worn While Working At This...	Notice	150
Ear Protection Picto	-	152
Ear Protection Required	Caution	144
Ear Protection Required	Danger	148
Ear Protection Required / Se Requiere Proteccion...	Danger / Peligro	55
Ear Protection Required At All Times	Danger	148
Ear Protection Required Beyond This Point	-	153
Ear Protection Required In This Area	Notice	150
Ear Protection Required In This Area	Warning	152
Ear Protection Required In This Area	Caution	144
Ear Protection Required In This Area / En Esta...	Caution / Precaucion	50
Ear Protection Required When Operating	Caution	144
Ear Protection Required When This Equipment Is ...	Caution	144
Ear Protection Required While Equipment Is Operating	Warning	152
Ear Protectors Required When In This Area More Than ...	Notice	150
Ear, Nose & Throat	-	116
Eating And Drinking Permitted Only In The Lunch Room	-	134
Eating, Drinking, And Smoking Prohibited	-	157
Efficiency Requires Cleanliness And Order	Notice	128
Electric Current Keep Away	Danger	89
Electric Fence	Danger	29
Electric Fence / Cerca Electricificada	Danger / Peligro	53
Electric Meter Room No Storage	Danger	89
Electric Spark Hazard No Cell Phones	Warning	90

Legend Text	Header	Pg
Electric Vehicle Charging Station	-	174
Electric Vehicle Charging Station	-	174
Electrical	-	158
Electrical Box Covers Must Be Closed At All Times	Danger	42
Electrical Box Covers Must Be Closed At All Times	Danger	89
Electrical Closet No Storage Permitted	-	90
Electrical Closet No Storage Permitted	Notice	90
Electrical Equipment Authorized Personnel Only	-	90
Electrical Equipment Authorized Personnel Only	Danger	30
Electrical Equipment Authorized Personnel Only	Danger	30
Electrical Equipment Authorized Personnel Only	Danger	42
Electrical Equipment Authorized Personnel Only	Danger	89
Electrical Equipment Authorized Personnel Only /...	Danger / Peligro	53
Electrical Equipment Authorized Personnel Only Will...	Danger	42
Electrical Equipment Authorized Personnel Only...	Danger	42
Electrical Hazard	Danger	89
Electrical Hazard Authorized Personnel Only	Danger	30
Electrical Hazard Authorized Personnel Only	Warning	33
Electrical Hazard Authorized Personnel Only Serious...	Warning	49
Electrical Picto	-	90
Electrical Room No Storage Permitted	Danger	42
Electrical Room No Storage Permitted	Danger	89
Electrical Room No Storage Permitted / Cuarto...	Notice / Aviso	56
Electrical Shock Hazard Do Not Touch	Danger	89
Electrical Supply Station Danger All Unauthorized...	-	33
Electricians Only	Danger	89
Electricity Picto	-	90
Elevator (Braille)	-	63
Elevator Out Of Order	Notice	128
Elevator Shaft	Danger	125
Eliminate Doubt Lock It Out	Caution	118
Emergency	-	116
Emergency And Authorized Vehicles Only	-	180
Emergency Assembly Point	-	98
Emergency Assembly Point	-	98
Emergency Breathing Apparatus Inside	-	108
Emergency Conveyor Stop	-	130
Emergency Door	-	91
Emergency Equipment W/Picto	-	91
Emergency Evacuation Point	-	91
Emergency Evacuation Route	-	92
Emergency Evacuation Route	-	92
Emergency Evacuation Route	-	92
Emergency Evacuation Route Picto	-	92
Emergency Exit	-	92
Emergency Exit	-	110
Emergency Exit	-	111
Emergency Exit (Braille)	-	63
Emergency Exit Do Not Block	-	101
Emergency Exit Only	-	92
Emergency Exit Only Keep Area Clear At All Times	-	92
Emergency Exit Only Security Alarm Will Sound If...	-	101
Emergency Exit Only: Alarm Will Sound	-	92
Emergency Exit Picto	-	92
Emergency Exit W/3 Left Arrows	-	92
Emergency Exit W/3 Right Arrows	-	92
Emergency Exit: Keep Area Clear	-	92
Emergency Eye Wash	Notice	107
Emergency Eye Wash	-	92
Emergency Eye Wash And Shower	Notice	107
Emergency Eye Wash Picto	-	99
Emergency Eye Wash Station	Notice	107
Emergency Fire Exit	-	101
Emergency Fuel Shutoff	-	75
Emergency Gas Shut-Off Do Not Block	-	75
Emergency Gasoline Shut Off	-	101
Emergency Only Pull Handle Down	-	101
Emergency Phone Numbers Fire Dept Police Dept...	-	92
Emergency Phone Picto	-	99
Emergency Response Kit	Notice	107
Emergency Room Parking Only	-	180
Emergency Shelter	-	92
Emergency Shelter For Hazardous Weather Conditions	-	101
Emergency Shower	Safety First	107
Emergency Shower	-	92
Emergency Shower	-	108
Emergency Shower And Eye Wash	-	108
Emergency Shower And Eye Wash / Ducha De...	-	58
Emergency Shower Eye Bath	Safety First	151
Emergency Shut Off	-	101
Emergency Shut-Off	Notice	90
Emergency Shutoff W/Down Arrow	-	113
Emergency Spill Response Equipment	-	75
Emergency Stairs	-	110
Emergency Stairs	-	111



# Sign Legend Index

BradyID.com/s34

Legend Text	Header	Pg
Emergency Stop	-	92
Emergency Stop Button	-	130
Emergency Stop Pull Cable	-	130
Emergency Telephone	-	92
Emergency Telephone Information	-	108
Emergency Use Only	-	101
Emergency Vehicles Only	-	180
Emergency Vehicles Only Beyond This Point	-	180
Employee Parking	-	180
Employees Are Not Permitted To Remove Guards Or...	<b>Safety First</b>	129
Employees Must Not Operate Machines Without...	<b>Safety First</b>	129
Employees Must Wash Hands Before Leaving Restroom	-	142
Employees Must Wash Hands Before Returning To Work	-	142
Employees Must Wash Hands Before Returning To...	-	59
Employees Only	-	87
Employees Only	-	168
Employees Only	<b>Caution</b>	28
Employees Only	<b>Danger</b>	30
Employees Only	<b>Notice</b>	31
Employees Only	<b>Parking</b>	177
Employees Only / Solo Empleados	<b>Notice / Aviso</b>	57
Employees Only / Solo Empleados	<b>Notice / Aviso</b>	57
Empty	-	75
Empty Acetylene Cylinders Do Not Use	-	75
Empty Co2 Cylinders Do Not Use	-	75
Empty Cylinders	-	75
Empty Cylinders Do Not Use	-	75
Empty Drums Only	<b>Notice</b>	72
Empty Nitrogen Cylinders Do Not Use	-	75
Empty Oxygen Cylinders Do Not Use	-	75
Empty Propane Cylinders Do Not Use	-	75
Emt Parking Only	-	180
End Utility Work	-	171
Energy Source	<b>Caution</b>	118
Engineering Dept.	-	87
Enter	-	180
Enter Here	-	180
Enter Only	-	180
Entrance	-	92
Entrance	-	172
Entrance (Braille)	-	63
Entrance For Employees Only	<b>Notice</b>	31
Entrance For Employees Only	<b>Restricted Area</b>	167
Entrance Only	-	92
Entrance Picto	-	92
Entry Prohibited Without Permit Test For O2...	<b>Caution</b>	28
Environmental, Health & Safety Dept.	-	87
Equipment Being Serviced Do Not Operate	<b>Danger</b>	118
Equipment Being Serviced Do Not Operate	<b>Danger</b>	118
Equipment Being Serviced Do Not Operate / Equip...	<b>Danger</b>	53
Equipment Being Serviced Do Not Operate Severe...	<b>Danger</b>	42
Equipment Being Serviced Do Not Operate Severe...	<b>Danger</b>	42
Equipment Is Not To Be Removed From This Area	-	130
Equipment Locked Out Do Not Remove Locks	<b>Danger</b>	119
Equipment Operated By Remote Control	<b>Caution</b>	120
Escape Ladder	-	93
Espacio Cerrado, Entrada Solo Con Autorizacion	<b>Peligro</b>	53
Este Equipo Se Enciende Automaticamente	<b>Peligro</b>	53
Ethyl Acetate	-	78
Ethyl Alcohol (Ethanol)	-	78
Ethylene Glycol	-	78
Ethylene Oxide Cancer Hazard And Reproductive...	<b>Danger</b>	68
Ev (On Charging Picto)	-	174
Evacuate This Area Immediately If Fire Alarm Sounds	<b>Warning</b>	100
Evacuation Assembly Area	-	101
Evacuation Assembly Point	-	98
Evacuation Assembly Point	-	98
Evacuation Route	-	93
Evacuation Slide Picto	-	99
Evaluation Letter "0" Picto	-	99
Evaluation Letter "1" Picto	-	99
Evaluation Letter "2" Picto	-	99
Evaluation Letter "3" Picto	-	99
Evaluation Letter "4" Picto	-	99
Evaluation Letter "5" Picto	-	99
Evaluation Letter "6" Picto	-	99
Evaluation Letter "7" Picto	-	99
Evaluation Letter "8" Picto	-	99
Evaluation Letter "9" Picto	-	99
Every Injury However Slight Must Be Reported ...	<b>Notice</b>	107
Every Machine In This Department Is Dangerous	<b>Be Careful</b>	120
Every Person Has The Responsibility And Authority...	-	188
Everyone Grinding Must Wear Goggles	<b>Safety First</b>	129
Except For Electric Vehicle Charging	-	174

Legend Text	Header	Pg
Excessive Noise Ear Protection Must Be Worn	<b>Danger</b>	148
Excessive Radio Frequency Fields Authorized ...	<b>Warning</b>	156
Exclusion Area Radiation Exposure Permit Required...	<b>Caution</b>	155
Exit	-	93
Exit	-	97
Exit	-	113
Exit	-	180
Exit	-	93
Exit	-	110
Exit	-	113
Exit	-	180
Exit - Running Man	-	96
Exit (Braille)	-	63
Exit / Salida	-	60
Exit Arrow	-	111
Exit Only	-	93
Exit Only	-	180
Exit Only Do Not Enter	-	180
Exit Only No Reentry To Building	-	101
Exit Picto	-	93
Exit Route Do Not Block	-	101
Exit Through Lobby Left Down)	-	96
Exit Through Lobby Right Down)	-	96
Exit W/Double Arrow Picto	-	93
Exit W/Double Headed Arrow Picto	-	93
Explosion	-	75
Explosion Relief Vent Stay Clear	<b>Danger</b>	68
Explosive 1.1A	-	79
Explosive 1.1B	-	79
Explosive 1.1C	-	79
Explosive 1.1D	-	79
Explosive 1.1E	-	79
Explosive 1.1F	-	79
Explosive 1.1G	-	79
Explosive 1.1J	-	79
Explosive 1.2B	-	79
Explosive 1.2C	-	79
Explosive 1.2D	-	79
Explosive 1.2E	-	79
Explosive 1.2F	-	79
Explosive 1.2G	-	79
Explosive 1.2H	-	79
Explosive 1.2J	-	79
Explosive 1.2K	-	79
Explosive 1.3C	-	79
Explosive 1.3F	-	79
Explosive 1.3G	-	79
Explosive 1.3H	-	79
Explosive 1.3J	-	79
Explosive 1.3K	-	79
Explosive 1.4B	-	79
Explosive 1.4C	-	79
Explosive 1.4D	-	79
Explosive 1.4E	-	79
Explosive 1.4F	-	79
Explosive 1.4G	-	79
Explosive Gas No Smoking	<b>Danger</b>	68
Explosive Gas No Smoking	<b>Danger</b>	68
Explosive Gas No Smoking Or Open Flames Within 20 Ft	<b>Danger</b>	68
Explosive Gases	-	75
Explosive Materials Authorized Personnel Only	<b>Danger</b>	30
Explosive Personality Keep Out	<b>Danger</b>	112
Explosive Vapor No Smoking No Open Flames No Sparks	<b>Danger</b>	68
Explosives	<b>Danger</b>	68
Explosives (W/ GHS Picto)	<b>Danger</b>	68
Explosives 1.1L	-	79
Explosives 1.2L	-	79
Explosives 1.3L	-	79
Explosives 1.4S	-	79
Explosives Follow Appropriate PreCautions. Serious...	<b>Danger</b>	42
Explosives Keep Away	<b>Danger</b>	68
Explosives Keep Out	<b>Danger</b>	30
Explosives Keep Out	<b>Warning</b>	73
Explosives Keep Out / Explosivos No Acercarse	<b>Danger / Peligro</b>	54
Extintor De Incendios	-	59
Extintor De Incendios	-	58
Extinguisher Do Not Block / Extinguidor No Obstruir	-	58
Extinguisher Missing Ext. #	-	101
Extremely Cold Liquid Nitrogen Do Not Touch	<b>Caution</b>	65
Eye And Ear Protection Must Be Work In This...	-	153
Eye And Ear Protection Must Be Worn Beyond This Point	<b>Caution</b>	144
Eye And Ear Protection Must Be Worn In This Area	<b>Caution</b>	144
Eye And Ear Protection Required In This Area	<b>Warning</b>	152
Eye And Ear Protection Required While Operating This ...	<b>Danger</b>	125



# Sign Legend Index

BradyID.com/s34

Legend Text	Header	Pg
Eye And Glove Protection Must Be Worn When Handling...	Caution	37
Eye And Glove Protection Must Be Worn When Handling...	Caution	65
Eye Protection And Hard Hats Must Be Worn In This Area	Caution	144
Eye Protection Area	-	111
Eye Protection Area	Danger	148
Eye Protection Area	-	110
Eye Protection Area	Caution	144
Eye Protection Glasses Picto	-	153
Eye Protection Goggles Picto	-	153
Eye Protection Must Be Worn	-	153
Eye Protection Must Be Worn In This Area	Safety First	151
Eye Protection Must Be Worn In This Area	-	153
Eye Protection Must Be Worn When Grinding	Notice	150
Eye Protection Must Be Worn When Operating This ...	Notice	128
Eye Protection Must Be Worn When Working On Batteries	Danger	148
Eye Protection Required	Caution	144
Eye Protection Required	Notice	150
Eye Protection Required	Caution	37
Eye Protection Required	Caution	144
Eye Protection Required / Se Requiere Proteccion...	Danger / Peligro	55
Eye Protection Required / Uso Obligatorio De...	Caution / Precaucion	51
Eye Protection Required Beyond This Point	Danger	148
Eye Protection Required In This Area	Safety First	151
Eye Protection Required In This Area	Warning	152
Eye Protection Required In This Area	Caution	37
Eye Protection Required In This Area	Caution	144
Eye Protection Required In This Area	Danger	42
Eye Protection Required In This Area / Es...	Danger / Peligro	53
Eye Protection Required In This Area Moderate...	Caution	37
Eye Protection Required In This Area. Serious...	Danger	42
Eye Protection Required Safety Glasses	-	153
Eye Protection Required Safety Glasses	Caution	144
Eye Protection Shall Be Worn In This Area	-	153
Eye Protection Shall Be Worn When Operating This ...	-	153
Eye Wash	-	108
Eye Wash	-	108
Eye Wash	-	110
Eye Wash	-	111
Eye Wash	-	113
Eye Wash Fountain	-	108
Eye Wash Fountain	Safety First	107
Eye Wash Picto	-	108
Eye Wash Station	-	108
Eye Wash Station	-	108
Eye Wash Station	Emergency	47
Eye Wash Station & Safety Shower	Emergency	47
Eye Wash Station Keep Area Clear	Emergency	48
Eye Wash/Lavado De Ojos	-	113

## F

Face Mask Picto	-	153
Face Mask Required	Caution	144
Face Shield Area	Caution	144
Face Shield Must Be Worn When Operating This Machine	Danger	42
Face Shield Must Be Worn When Operating This Machine	Danger	125
Face Shield Picto	-	153
Face Shield Required In This Area	Danger	148
Face Shield Required In This Area	Notice	150
Face Shields Or Goggles Must Be Worn In Addition...	Caution	144
Faculty And Staff Parking	-	180
Fall Hazard	Caution	120
Fall Hazard . Injury May Result	Caution	37
Fall Hazard Do Not Start Work Unless Guardrail,...	-	153
Fall Protection Required	Caution	144
Fall Protection Required In This Area	Caution	144
Fall Protection Required In This Area	Danger	148
Fall Protection Required In This Area	Warning	152
Falling Material	Danger	42
Falling Material	Danger	125
Family Practice	-	116
Fasten Seat Belts Picto	-	99
Federal Regulations Require No Food To Be Stored...	Notice	132
Fedex Pick Up	-	180
Fiber Optic Cable Above	-	170
Film Badge Required In This Area	Caution	155
Final Exit Left Down)	-	96
Final Exit Right Down)	-	96
Fire Alarm	-	101
Fire Alarm	-	113
Fire Alarm	-	102
Fire Alarm	-	110
Fire Alarm	-	111

Legend Text	Header	Pg
Fire Alarm	-	113
Fire Alarm & Fire Picto	-	101
Fire Alarm Call Fire Dept.	-	101
Fire Alarm Inside	-	102
Fire Alarm Panel	-	102
Fire Alarm W/Down Arrow	-	113
Fire Alarm W/Fire Alarm & Fire Picto	-	102
Fire And Explosion Hazard No Smoking Or Open Flames	Danger	136
Fire Assembly Point	-	98
Fire Assembly Point	-	98
Fire Blanket	-	102
Fire Blanket	-	109
Fire Damper	-	102
Fire Department Connections	-	102
Fire Department Sprinkler Connection	-	102
Fire Dept Use Only	-	102
Fire Door Alarm Will Sound If Door Is Opened Do Not ...	-	102
Fire Door Do Not Block	-	87
Fire Door Do Not Block	-	102
Fire Door Do Not Block	Caution	86
Fire Door Do Not Block / Puerta De Emergencia No ...	-	60
Fire Door Emergency Only Violators Subject To Discipline	-	87
Fire Door Keep Closed	-	87
Fire Door Keep Closed	-	102
Fire Door Keep Closed	Caution	86
Fire Door Keep Closed Do Not Block	-	102
Fire Equipment	-	102
Fire Equipment	-	113
Fire Equipment Do Not Block	-	102
Fire Equipment Keep Clear	-	102
Fire Escape	-	102
Fire Escape Picto	-	102
Fire Exit	-	102
Fire Exit Door Must Be Kept Unlocked During Business ...	-	102
Fire Exit Keep Clear	-	102
Fire Exit Picto	-	102
Fire Exit Picto	-	103
Fire Exit Please Keep Door Closed	-	102
Fire Exit Please Keep Door Closed / Salida Para...	-	60
Fire Extinguisher	-	103
Fire Extinguisher	-	104
Fire Extinguisher	-	113
Fire Extinguisher	-	114
Fire Extinguisher	-	49
Fire Extinguisher	-	111
Fire Extinguisher (Braille)	-	63
Fire Extinguisher (W/Changeable Arrow)	-	104
Fire Extinguisher / Extinguidor De Incendios	-	59
Fire Extinguisher / Extinguidor De Incendios	-	58
Fire Extinguisher & Fire Picto	-	103
Fire Extinguisher Area In Front Must Be Kept Clear...	-	103
Fire Extinguisher Do Not Block	-	103
Fire Extinguisher Do Not Block / Extinguidor De...	-	59
Fire Extinguisher For All Purpose	-	103
Fire Extinguisher Halon	-	103
Fire Extinguisher Here	-	103
Fire Extinguisher In Case Of Fire Break Glass	-	103
Fire Extinguisher Inside	-	103
Fire Extinguisher Inside	-	103
Fire Extinguisher Inside Building	-	103
Fire Extinguisher Keep Clear At All Times	-	103
Fire Extinguisher Picto	-	103
Fire Extinguisher Picto	-	104
Fire Extinguisher Remove Pin And Squeeze Trigger	-	49
Fire Extinguisher Use For All Fires A B C	-	104
Fire Extinguisher Use On All Fires A B C	-	104
Fire Extinguisher W/Down Arrow	-	114
Fire Extinguisher W/Down Arrow & Extinguisher Picto	-	104
Fire Extinguisher/Extinto De Incendios	-	113
Fire Fighting Equipment Stored Inside	-	104
Fire Hose	-	104
Fire Hose	-	105
Fire Hose	-	114
Fire Hose	-	104
Fire Hose	-	105
Fire Hose	-	110
Fire Hose	-	111
Fire Hose	-	114
Fire Hose And Extinguisher Inside	-	104
Fire Hose And Fire Picto	-	104
Fire Hose Picto	-	104
Fire Hose Picto	-	105
Fire Hydrant Picto	-	180



# Sign Legend Index

BradyID.com/s34

Legend Text	Header	Pg
Fire Lane Keep Clear	Caution	100
Fire Lane Keep Clear At All Times	No Parking	100
Fire Lane Keep Clear At All Times	Notice	100
Fire Lane No Parking Tow-Away Zone	-	180
Fire Lane No Parking Tow-Away Zone	-	180
Fire Regulations Demand That This Space Be Kept...	Caution	100
Fire Regulations Demand That This Space Is Clear ...	Notice	100
Fire Regulations Demand This Space Be Kept Clea...	-	105
Fire Sprinkler Shut-Off Valve	-	105
Fire-Police-Medical Emergency Dial 911	-	105
First Aid	First Aid	110
First Aid	-	111
First Aid	-	2
First Aid	-	49
First Aid	-	109
First Aid	-	110
First Aid	-	111
First Aid	-	114
First Aid Equipment	-	109
First Aid Kit	Safety First	107
First Aid Kit	-	109
First Aid Kit Inside	-	109
First Aid Location	Safety First	107
First Aid Picto	-	109
First Aid Room	-	109
First Aid Station	Safety First	107
First Aid Station	-	2
First Aid Station	Emergency	48
First Aid Station / Estacion De Primeros Auxilios	-	58
First Aid Station In Office	Safety First	107
First Aid Station In Personnel Room	Safety First	107
First Aid/Medical Locker Picto	-	99
Fishing And Hunting Stories In Progress Protective...	Caution	112
Flagger Ahead	-	171
Flagger Picto	-	171
Flammable	Danger	68
Flammable 3	-	80
Flammable Area	Warning	100
Flammable Gas	Danger	68
Flammable Gas	Danger	43
Flammable Gas (W/ GHS Picto)	Danger	68
Flammable Gas / Gas Inflamable	Danger / Peligro	54
Flammable Gas Keep Fire Or Flame Away No Smoking	Danger	68
Flammable Gas Keep Fire Or Flame Away No...	Danger	43
Flammable Gas Keep Fire Or Flame Away No...	Danger / Peligro	54
Flammable Keep Fire Away	Danger	100
Flammable Keep Flames And Heat Away	Danger	68
Flammable Keep Flames And Heat Away Death Or...	Danger	43
Flammable Liquid	Warning	100
Flammable Liquids	Caution	65
Flammable Liquids	Danger	68
Flammable Liquids	Danger	43
Flammable Liquids No Smoking	Restricted Area	137
Flammable Liquids No Smoking, Matches Or Open Lights	Danger	68
Flammable Material Keep Fire Away	Danger	43
Flammable Material No Smoking	Danger	69
Flammable Material No Smoking Death Or Serious...	Danger	43
Flammable Material No Smoking Within 20 Feet	Danger	69
Flammable Material No Smoking Within 20 Feet Death...	Danger	43
Flammable Materials	Danger	69
Flammable Materials	Danger	43
Flammable Materials (W/ GHS Picto)	Danger	68
Flammable Materials / Materiales Inflamables	Danger / Peligro	54
Flammable No Matches Or Open Lights	Danger	69
Flammable No Smoking	-	138
Flammable No Smoking Or Open Flame Within ___ Feet	-	75
Flammable No Smoking Or Open Flame Within ___ Feet	-	138
Flammable No Smoking Or Open Flames Resulting...	Danger	43
Flammable Picto	-	75
Flammable Picto	-	80
Flammable Solid 4	-	80
Floor Load Limit No To Exceed ___ Lbs. Sq. Ft. / Et...	Caution / Precaucion	50
Floor Load Limit Not To Exceed ___ Lbs Sq Ft	Caution	132
Floor Opening Do Not Remove	Caution	144
Floor Slippery When Wet	Caution	37
Floor Slippery When Wet	Danger	148
Floor Slippery When Wet	Caution	37
Floorboards Out	Danger	85
Fluorescent Tubes	-	158
Flush Toilet After Using	Please	133
Flying Debris Hazard Keep Door Closed While In ...	Danger	69
Foam Inlet W/Hard Hat & Fire Picto	-	105
Follow Confined Space Entry Procedure Before Entering	Danger	84
Follow Fall Protection Guidelines When Working...	Notice	150

Legend Text	Header	Pg
Follow Lockout/Tagout Procedures	Danger	43
Food Prep Area	-	130
Food Preparation Area Cooked Food Only	-	130
Food Preparation Area Raw Food Only	-	130
Foot Protection Required	Caution	145
Foot Protection Required In This Area	Safety First	151
Foot Protection Required In This Area	Caution	145
For Chemical Storage Only No Food Permitted	Notice	72
For Fire Use Only	-	105
For Security Reasons Individuals Entering Or...	Notice	167
For Use On All Fires	-	105
For Your Own Safety Talk Safety	Safety First	165
Fork Lift Trucks Go Slow	Caution	120
Fork Lift Trucks Operating Beyond This Point	Caution	169
Forklift Traffic Keep Clear	Caution	37
Forklift Traffic Keep Clear / Trafico De Montacargas...	Caution / Precaucion	51
Forklift Traffic Stay Clear	Danger	77
Formaldehyde Irritant And Potential Cancer Hazard...	Danger	69
Formic Acid	-	78
Formwork Stripping Area Falling Material Do Not...	Danger / Peligro	55
Fr Clothing Required	Caution	145
Fragile Equipment Do Not Touch	Caution	120
Freezing Temperature When Blue	-	130
Front End Parking Only	-	180
Fuel	Danger	69
Fuel Oil	-	78
Fuel Oil	Danger	69
Fuel Oil 3	-	80
Fuel Storage No Smoking	Danger	136
Full	-	76
Full Acetylene Cylinders Ready For Use	-	76
Full Co2 Cylinders Ready For Use	-	76
Full Cylinders	-	76
Full Cylinders Ready For Use	-	76
Full Face Respirator Must Be Worn In This Area	Caution	145
Full Nitrogen Cylinders Ready For Use	-	76
Full Oxygen Cylinders Ready For Use	-	76
Full Propane Cylinders Ready For Use	-	76
Fumes May Be Present	Caution	65
Fumes May Be Present	Warning	73

## G

Gas	Danger	69
Gas Cylinder Storage Area	Danger	69
Gas Mask Picto	-	153
Gas No Smoking, Matches Or Lights	-	76
Gas Only	-	76
Gasoline	-	78
Gasoline	Warning	73
Gasoline And Oil	Danger	69
Gasoline No Smoking	Danger	69
Gates Open And Close Automatically	-	33
Gates Open And Close Automatically	Danger	30
Genetics	-	116
Girls	-	159
Glass Only	-	158
Gloves Picto	-	153
Gloves Required	Caution	145
Gloves Required	Caution	145
Gloves Required / Uso Obligatorio De Guantes	Caution / Precaucion	51
Gloves Required In This Area	Caution	145
Go Slow Sound Signal	Danger	177
Goggles Must Be Worn When Working In This Area ...	Caution	145
Goggles Positively Must Be Worn	Caution	145
Good Housekeeping Is The First Principle Of Safety	-	134
Good Housekeeping Promotes Safety	-	160
Good Housekeeping Promotes Safety Do Your Part	-	134
Good Housekeeping This Is Your Home Away From...	-	134
Ground All Barrels	Caution	88
Guard Dogs On Duty	Danger	30

## H

H2S May Be Present	Danger	69
H2S May Be Present. No Open Flames. Wear Necessary...	Danger	43
H2S Poisonous Gas	Danger	69
H2S Poisonous Gas May Be Present	Caution	65
H2S Poisonous Gas May Be Present. No Open Flames....	Caution	37
H2S Poisonous Gas May Be Present. No Open Flames....	Caution	37
H2S Poisonous Gas. No Open Flames. Wear...	Danger	43
Hair And Beard Nets Required	-	153
Hair Covering Required In This Area	Notice	150
Hair Net Required Beyond This Point	Notice	150

# Sign Legend Index

BradyID.com/s34

Legend Text	Header	Pg
Hairnets And Beard Covers Required In This Area	Notice	150
Halon Extinguisher For Use On Computer Equipment...	-	105
Halon W/Hard Hat & Fire Picto	-	105
Hand Hazard Turn Power Off Before Reaching In	Danger	125
Hand Hazard Watch Your Fingers	Danger	125
Hand Signals For Shovel-Crane Operation	-	130
Hand Wash Only	-	134
Handcapped Parking Van Accessible	-	172
Handicapped	-	172
Handicapped / Picto Only	-	172
Handicapped Parking	-	172
Handicapped Parking Only	-	172
Handicapped Parking Permit Required	-	172
Handicapped Parking State Permit Required	-	173
Handicapped Parking Towing Enforced	-	173
Handicapped Picto	-	110
Handicapped Picto (Braille)	-	63
Hard Hat Area	-	153
Hard Hat Area	Caution	170
Hard Hat Area	Danger	125
Hard Hat Area	Warning	152
Hard Hat Area	-	110
Hard Hat Area	-	111
Hard Hat Area	Danger	43
Hard Hat Area / Usar Casco Protector En Esta Area	Danger / Peligro	55
Hard Hat Picto	-	153
Hard Hat Protection Required	Danger	148
Hard Hat Required Beyond This Point	Caution	170
Hard Hat Required Beyond This Point	Danger	148
Hard Hat Required In This Area	Danger	43
Hard Hat, Safety Glasses And Hearing Protection Must ...	-	188
Hard Hats - Safety Glasses - Safety Shoes Required...	Caution	143
Hard Hats And Eye Protection Required In This Area	Notice	150
Hard Hats And Fall Protection Must Be Worn When...	Notice	150
Hard Hats And Safety Glasses With Clear Lenses And...	-	188
Hard Hats Ear And Eye Protection Required Beyond ...	Danger	149
Hard Hats Ear And Eye Required Protection Beyond ...	Danger	149
Hard Hats Must Be Worn At All Times	-	188
Hard Hats Must Be Worn In This Area	-	188
Hard Hats Must Be Worn In This Area	Notice	150
Hard Hats Must Be Worn In This Area / Se Debe...	Notice / Aviso	57
Hard Hats Must Be Worn On Site	Danger	149
Hard Hats Must Be Worn On This Contruction Project	Notice	150
Hard Hats Required	Caution	145
Hard Hats Required	Caution	37
Hard Hats Required	Caution	145
Hard Hats Required / Uso Obligatorio De Casco De ...	Caution / Precaucion	51
Hard Hats Required In This Area	Caution	145
Hard Hats Required In This Area	Notice	150
Hard Hats Required In This Area. / Es Obligatorio...	Danger / Peligro	53
Hard Hats Required On This Job By All Employees	-	153
Hard Hats Required When This Equipment Is Operating	-	153
Hard Hats, Safety Glasses, Safety Shoes Required...	Caution	145
Hard Hats, Safety Glasses, Safety Shoes Required...	Caution	145
Hard Head Area	Danger	112
Haute Tension	Danger	89
Have You Hugged Your Maintenance Manager Today?	Notice	112
Have You Hugged Your Safety Manager Today?	Notice	112
Hazard Area No Unauthorized Personnel Beyond This ...	Danger	43
Hazard Area No Unauthorized Personnel Beyond This...	Danger	30
Hazardous Area	Danger	69
Hazardous Area Authorized Personnel Only	Caution	28
Hazardous Area No Smoking	-	138
Hazardous Area.	Danger	43
Hazardous Chemicals	Danger	69
Hazardous Chemicals	Danger	69
Hazardous Chemicals / Sustancias Quimicas Peligrosas	Danger / Peligro	55
Hazardous Chemicals Authorized Personnel Only	Caution	65
Hazardous Chemicals. Improper Contact Will Result...	Danger	43
Hazardous Material Area Authorized Personnel Only	Danger	43
Hazardous Material Area Authorized Personnel Only	Danger	69
Hazardous Material Check Msds	Danger	69
Hazardous Material Storage Area	Warning	73
Hazardous Material Storage Area	Warning	49
Hazardous Materials	Danger	69
Hazardous Materials Handle With Care	Caution	65
Hazardous Materials Improper Contact Will Result...	Danger	43
Hazardous Materials May Be Used In This Area See Msds	Caution	65
Hazardous Waste	Danger	69
Hazardous Waste	Warning	73
Hazardous Waste	Danger	43
Hazardous Waste Area Labeled Drums Only	Caution	65
Hazardous Waste Material Storage Only No Smoking...	Caution	37

Legend Text	Header	Pg
Hazardous Waste Material Storage Only No Smoking...	Caution	65
Hazardous Waste Material Storage Only No Smoking...	Caution / Precaucion	50
Hazardous Waste Oil	Danger	69
Hazardous Waste Storage	-	76
Hazardous Waste Storage	Danger	69
Hazardous Waste Storage Area Unauthorized Persons...	Danger / Peligro	52
Hazardous Waste Storage Area Unauthorized Persons...	Caution	37
Hazardous Waste Storage Area Unauthorized Persons...	Caution	65
Hazardous Waste Storage Area Unauthorized Persons...	Danger	30
Hazardous Waste Storage Area Unauthorized Persons...	Danger	43
Hazardous Waste Treatment Area Unauthorized ...	Danger	69
Head In Parking Only	-	180
Head In To Park	-	180
Head Protection Must Be Worn	-	153
Health Education	-	116
Health Hints Clean Toilet Rooms Mean Good Health...	-	134
Health Services	-	116
Hearing Protection And Safety Glasses Must Be Worn	-	188
Hearing Protection And Safety Glasses Must Be Worn...	Notice	150
Hearing Protection And Safety Glasses Must Be Worn...	Notice / Aviso	56
Hearing Protection Must Be Worn At All Times	-	188
Hearing Protection Must Be Worn In This Area	-	188
Hearing Protection Must Be Worn In This Area	Caution	145
Hearing Protection Must Be Worn In This Area	Notice	150
Hearing Protection Must Be Worn In This Area...	Notice / Aviso	56
Hearing Protection Required	Caution	145
Hearing Protection Required	Caution	145
Hearing Protection Required After ___ Hr(S) ___ Db	Caution	145
Hearing Protection Required Beyond This Point	Caution	170
Hearing Protection Required Beyond This Point	Danger	149
Hearing Protection Required For Prolonged Exposure...	Caution	145
Hearing Protection Required Here	-	153
Hearing Protection Required Here	Caution	145
Hearing Protection Required In This Area	Danger	149
Hearing Protection Required In This Area	Warning	152
Hearing Protection Required In This Area	Caution	37
Hearing Protection Required In This Area Hearing...	Caution	38
Hearing Protection Required While Equipment Is ...	Caution	145
Hearing Protection Required. / Uso Obligatorio De...	Caution / Precaucion	51
Hearing Protection Required. / Uso Obligatorio De...	Danger / Peligro	55
Heart Pacemaker Implants This Room Contains An...	Caution	155
Helium Empty Cylinders	-	76
Helium Full Cylinders	-	76
Helium Neon Laser Do Not Stare Into Beam	Caution	155
Help Keep Our Facility Clean	-	189
Help Keep This Fountain Clean And Sanitary Do Not...	Notice	132
Help Keep This Place Clean	-	134
Help Keep This Place Clean / Ayude A Mantener...	-	58
Help Keep This Plant Clean Put Rubbish And Scrap...	Notice	132
Help Keep This Plant Safe And Clean	Notice	133
Heptane	-	78
Hexane	-	78
Hexavalent Chromium Chromium (VI) Or Cr (VI)...	Danger	69
High Explosives	Danger	69
High Impact Safety Glasses Area	Danger	149
High Impact Safety Glasses Beyond This Point	Notice	150
High Impact Safety Glasses Required	Caution	145
High Intensity Ultraviolet Light Wear Eye Protection	Caution	146
High Noise Area Hearing Protection May Be Required	Caution	146
High Noise Area Wear Ear Plugs	Notice	150
High Noise Area Wear Ear Protection	Warning	152
High Noise Area Wear Ear Protection	Danger	43
High Noise Area Wear Hearing Protection	Caution	146
High Noise Level Area	Caution	146
High Noise Level Use Ear Protection	Caution	146
High Pressure	Danger	69
High Pressure Air Authorized Personnel Only	Warning	73
High Pressure Gas Line	Danger	43
High Pressure Gas Line	Danger	69
High Pressure Pipeline	Caution	65
High Pressure.	Danger	43
High Radiation Area	-	157
High Speed Saw	Danger	125
High Voltage	-	90
High Voltage	Danger	89
High Voltage	Danger	170
High Voltage	Warning	90
High Voltage	Danger	44
High Voltage	Danger	89
High Voltage ___Volts	Danger	90
High Voltage / Alto Voltaje	Danger / Peligro	52
High Voltage Above	Danger	89
High Voltage Above	Danger	89



# Sign Legend Index

BradyID.com/s34

Legend Text	Header	Pg
High Voltage Above Contact Will Cause Serious...	<b>Danger</b>	44
High Voltage Authorized Personnel Only	<b>Danger</b>	89
High Voltage Authorized Personnel Only Contact...	<b>Danger</b>	44
High Voltage Contact Could Result In Serious Shock...	<b>Warning</b>	49
High Voltage Contact Will Result In Serious Shock...	<b>Danger</b>	44
High Voltage Do Not Remove This Barrier	<b>Danger</b>	89
High Voltage Electrical Equipment	<b>Danger</b>	89
High Voltage Inside	<b>Danger</b>	89
High Voltage Keep Away	<b>Warning</b>	90
High Voltage Keep Away	<b>Danger</b>	89
High Voltage Keep Away Contact Will Result In...	<b>Danger</b>	44
High Voltage Keep Off	<b>Danger</b>	89
High Voltage Keep Out	-	90
High Voltage Keep Out	<b>Danger</b>	30
High Voltage Keep Out	<b>Danger</b>	170
High Voltage Keep Out	<b>Danger</b>	30
High Voltage Keep Out	<b>Danger</b>	44
High Voltage Keep Out / Alto Voltaje No Acercarse	<b>Danger / Peligro</b>	52
High Voltage Keep Out Will Result In Serious Shock...	<b>Danger</b>	44
High Voltage On Wires Above	<b>Danger</b>	89
High Voltage Overhead	<b>Danger</b>	89
High Voltage Overhead	<b>Danger</b>	89
High Voltage Picto	-	90
High Voltage Testing In Progress	<b>Danger</b>	89
High Voltage Turn Power Off And Lock Out Before ...	<b>Danger</b>	119
High Voltage Turn Power Off Before Servicing	<b>Danger</b>	44
High Voltage Turn Power Off Before Servicing	<b>Danger</b>	44
High Voltage Unauthorized Personnel Keep Out	<b>Danger</b>	30
High Voltage Underground Cable	<b>Danger</b>	90
High Voltage Will Result In Serious Shock Or Death	<b>Danger</b>	44
High Voltage Will Result In Shock Or Death	<b>Danger</b>	44
High Voltage Within	<b>Danger</b>	90
High Voltage Within Keep Out	<b>Danger</b>	90
High Voltage Within Keep Out Contact Will Result...	<b>Danger</b>	44
High Voltage: Do Not Enter This Enclosure	<b>Caution</b>	88
Highly Combustible Area No Welding, Burning Or...	<b>Danger</b>	69
Highly Flammable	<b>Danger</b>	69
Highly Toxic Handle With Care	<b>Danger</b>	69
Hole Cover Do Not Remove / Cubierta De Hoyo No ...	<b>Danger / Peligro</b>	53
Hospital Visitor Parking Only	-	180
Hot	-	131
Hot	<b>Caution</b>	121
Hot	<b>Danger</b>	125
Hot	<b>Warning</b>	129
Hot	<b>Danger</b>	44
Hot	<b>Danger</b>	125
Hot / Caliente	<b>Danger / Peligro</b>	53
Hot / Caliente	<b>Danger / Peligro</b>	53
Hot Acid	<b>Danger</b>	70
Hot Contact Can Result In Severe Burns Or Injury	<b>Warning</b>	49
Hot Contact May Result In Injury.	<b>Caution</b>	38
Hot Do Not Touch	<b>Danger</b>	125
Hot Do Not Touch. Will Cause Severe Burns Or Injury	<b>Danger</b>	44
Hot Equipment Unauthorized Persons Keep Out	<b>Danger</b>	125
Hot Keep Away	<b>Caution</b>	121
Hot Keep Away Injury May Result	<b>Caution</b>	38
Hot Lead Use Protective Equipment	<b>Danger</b>	70
Hot Metal	<b>Danger</b>	85
Hot Pipes	<b>Danger</b>	70
Hot Pipes Do Not Touch	<b>Danger</b>	85
Hot Surface Do Not Touch	<b>Caution</b>	38
Hot Surface Do Not Touch	<b>Danger</b>	44
Hot Surface Do Not Touch	<b>Danger</b>	125
Hot Surface Do Not Touch / Superficie Caliente No Tocar	<b>Caution / Precaucion</b>	51
Hot Surface Picto	-	131
Hot Will Cause Severe Burns Or Injury.	<b>Danger</b>	44
Hot Will Result In Serious Burns Or Injury	<b>Danger</b>	44
Hot Work Area	<b>Caution</b>	38
Hot Work Area	<b>Caution</b>	121
Hot Work Area	<b>Caution</b>	38
Hot Work Fire Watch Area	<b>Danger</b>	85
Hot Work Permits Are Required For All Welding And...	<b>Notice</b>	128
Household & Garden Chemicals	-	158
How To Lift Correctly...	-	109
Hunting Or Fishing On These Grounds Prohibited...	-	33
Hydrochloric Acid	-	78
Hydrochloric Acid	<b>Danger</b>	70
Hydrochloric Acid (Hcl)	<b>Danger</b>	70
Hydrochloric Acid. Improper Contact Will Cause...	<b>Danger</b>	44
Hydrofluoric Acid	-	78
Hydrofluorsilicic Acid	-	78
Hydrogen	<b>Danger</b>	70
Hydrogen Flammable Gas No Smoking Or Open Flames	<b>Danger</b>	70
Hydrogen Peroxide	<b>Danger</b>	70

Legend Text	Header	Pg
Hydrogen Peroxide, 52%	-	78
Hydrogen Sulfide (H2S)	<b>Danger</b>	70
Hydrogen. Flammable Gas. No Smoking Or Open Flames.	<b>Danger</b>	44
<b>I</b>		
I'm So Far Behind I Might Run Over Myself	<b>Notice</b>	112
Icy Conditions When Blue	-	131
Icy Surface	<b>Caution</b>	121
If Fire Alarm Sounds Call Fire Dept.	-	105
If Machine Is Not Operating Properly Advise Supervisor ...	<b>Danger</b>	125
If We Are To Have Efficiency In Our Organization,...	<b>Notice</b>	133
If You Drop It Pick It Up If You Spill It Wipe It Up	-	134
If You Get Chemicals On Your Body Or Eyes Wash...	<b>Safety First</b>	72
If You Think OSHA Is A Small Town In Wisconsin...	<b>Caution</b>	112
If You Use It Clean It	-	134
Illegally Parked Cars Will Be Towed Away At Owners ...	-	180
Illegally Parked Vehicles Will Be Towed At Owners ...	-	180
Imaging	-	116
Immersion Suit Picto	-	99
Immunizations	-	116
Impaired Headroom	<b>Caution</b>	121
Improper Disposal Of Chemicals Is Punishable By...	<b>Notice</b>	72
Improper Disposal Of Chemicals Is Punishable By...	<b>Warning</b>	73
In	-	87
In Accordance With OSHA Standard 1910147...Etc	<b>Notice</b>	119
In Case Of Emergency Break Glass	-	105
In Case Of Emergency Dial 9 Then 911	-	105
In Case Of Emergency Dial 911	-	109
In Case Of Emergency Report To Evacuation Area	-	105
In Case Of Fire Assembly Point Is...	-	105
In Case Of Fire Do Not Use Elevator Use The Stairs...	-	60
In Case Of Fire Do Not Use Elevators Use Stairways...	-	105
In Case Of Fire Pull Firmly Here	-	105
In Case Of Fire Unreel Hose Completely Then Open Valve	-	105
Infection Hazard Handle Needles With Care	<b>Danger</b>	61
Infectious Diseases	-	116
Infectious Waste Area	<b>Danger</b>	61
Infectious Waste Area Use PreCautions	<b>Danger</b>	61
Infectious Waste Notify Public Health Authority...	-	61
Inflamable W/Picto	<b>Peligro</b>	54
Inhalation Hazard 2	-	80
Inhalation Hazard 6	-	80
Inhalation Hazard Do Not Breathe Vapors	<b>Danger</b>	70
Inorganic Arsenic Cancer Hazard Authorized Personnel...	<b>Danger</b>	70
Inpatient	-	116
Inspect Slings Before Use	<b>Caution</b>	121
Intensive Care	-	117
Internal Medecine	-	117
Internal Medicine	-	117
Interpretive Services	-	117
Is Our Responsibility Each And Every One Of Us	<b>Safety First</b>	165
Isopropanol	-	78
Isopropyl Acetate	-	78
It Is Illegal & Against Company Policy To Dispose...	<b>Warning</b>	73
It Is Unlawful And Dangerous To Dispense Gasoline...	<b>Warning</b>	73
<b>J</b>		
Just Do It Safely	-	160
<b>K</b>		
Keep Aisles Clear	-	111
Keep Aisles Clear	<b>Caution</b>	176
Keep Aisles Clear	-	110
Keep Aisles Clear If It's Not Moving It Does Not...	<b>Caution</b>	132
Keep All Aisles Clear	<b>Caution</b>	132
Keep All Cylinders Chained	<b>Caution</b>	65
Keep All Cylinders Chained	<b>Danger</b>	45
Keep All Cylinders Chained	<b>Warning</b>	49
Keep All Cylinders Chained	<b>Danger</b>	70
Keep All Cylinders Chained / Mantener Los Cilindros ...	<b>Warning / Advertencia</b>	58
Keep All Cylinders Chained / Mantener Todos Los...	<b>Caution / Precaucion</b>	50
Keep All Cylinders Chained / Mantener Todos Los...	<b>Danger / Peligro</b>	54
Keep All Guards In Place Wear Goggles	<b>Be Careful</b>	143
Keep Area Clean / Mantener Limpia Esta Area	<b>Notice / Aviso</b>	57
Keep Away	<b>Caution</b>	28
Keep Away	<b>Danger</b>	30
Keep Away Do Not Climb Over This Enclosure	<b>Danger</b>	30
Keep Away From Heat	<b>Danger</b>	70
Keep Clear When Boom Is Near High Voltage	<b>Caution</b>	121
Keep Closed	<b>Caution</b>	86
Keep Cylinders Chained	<b>Notice</b>	72
Keep Door Closed	<b>Notice</b>	48

# Sign Legend Index

BradyID.com/s34

Legend Text	Header	Pg
Keep Door Closed At All Times	-	87
Keep Electric Panel Area Clear	Caution	38
Keep Electric Panel Area Clear	Caution	88
Keep Electric Panel Area Clear	Caution	38
Keep Electrical Panel Clear For 36 Inches	Caution	38
Keep Electrical Panel Clear For 36 Inches	Caution	88
Keep Everything Away From This Fire Door So That...	Notice	86
Keep Fingers Clear Of Machine While In Motion	Danger	125
Keep Floors Clear Of Oil-Grease Or Other Slippery...	Safety First	129
Keep From Under Conveyor	Danger	125
Keep Gates Closed	-	34
Keep Gates Closed	Danger	30
Keep Guards In Place	Danger	125
Keep Guards In Place / Mantener Las Guardas En Su...	Danger / Peligro	54
Keep Hands Clear	Danger	125
Keep Hands Clear / Mantener Las Manos Alejadas	Danger / Peligro	54
Keep Hands Clear Of Moving Machinery	Warning	129
Keep Hands Clear When Equipment Is Running / No...	-	59
Keep Hands Clear While Blades Are Turning	Danger	125
Keep Hands Off	Caution	121
Keep Hands Out Of Machinery	Warning	49
Keep Hands Out Of Moving Machinery	Safety First	129
Keep Hands Out Of Moving Machinery / Mantener...	Caution / Precaucion	50
Keep Material Away From Fire Door So The Door Is...	Caution	132
Keep Off	Danger	30
Keep Off	Danger	45
Keep Off	Warning	33
Keep Off Roof	Danger	30
Keep Off Tracks	Danger	177
Keep Our Plant Clean And Safe	-	160
Keep Out	-	34
Keep Out	Caution	28
Keep Out	Danger	30
Keep Out	Danger	45
Keep Out	Restricted Area	33
Keep Out Authorized Personnel Only	-	168
Keep Out From Under Crane Loads	Caution	121
Keep Out Fumigating With Poisonous Gas	Danger	70
Keep Out Hazard Area	Danger	30
Keep Out Hazardous Chemicals	Danger	70
Keep Out Radiation Area X-Ray Keep Out	-	157
Keep Passageway And Doorway Clear	Notice	91
Keep Right	-	181
Keep Storage 36" Below Sprinklers	-	106
Keep This Area Clean	Notice	133
Keep This Area Clean	Safety First	133
Keep This Area Clean Your Mother Isn't Here...So...	-	134
Keep This Area Clear	Notice	100
Keep This Door Closed	Caution	86
Keep This Door Closed	Notice	31
Keep This Door Closed	Notice	86
Keep This Door Closed	Notice	48
Keep This Door Closed	Notice	86
Keep This Door Closed / Mantener Esta Puerta Cerrada	Notice / Aviso	57
Keep This Door Closed At All Times	Notice	128
Keep This Doorway Free Of Obstructions So Fire...	Notice	100
Keep This Gate Closed	Danger	45
Keep This Gate Closed	Danger	125
Keep This Passageway Clear	Notice	177
Keep This Place Clean And Orderly	-	134
Keep This Place Clean And Orderly	Please	133
Keep This Place Clean And Orderly	Notice	48
Keep This Plant Safe And Clean	Safety First	133
Keep This Space Clear At All Times	-	134
Keep This Space Clear At All Times	Caution	132
Keep Your Work Area Clean It Is Part Of Your Job	-	134
Kerosene	-	78
Kerosene No Smoking No Open Flames	Danger	70
Kidney	-	117
<b>L</b>		
Label All Drums	Notice	72
Laboratory	-	117
Ladies	-	159
Laser Area	Caution	155
Laser Area Vision Damage May Result	Caution	38
Laser Beams Do Not Look Directly At Laser Lights	Danger	155
Laser Beams Do Not Look Directly At Laser Lights...	Danger	45
Laser Operating	Warning	156
Laser Operating Protect Eyes And Skin From Beam	Danger	45
Laser Radiation Avoid Direct Exposure To Beam Class...	Danger	45
Laser Radiation Avoid Direct Exposure To Beam Class...	Danger	155
Laser Radiation Avoid Direct Exposure To Beam Class...	Danger	155
Laser Radiation Avoid Eye Or Skin Exposure To...	Danger	45

Legend Text	Header	Pg
Laser Radiation Avoid Eye Or Skin Exposure To...	Danger	155
Laser Radiation Do Not Stare Into Beam Or View...	Caution	146
Laser Range In Use Do Not Enter	Danger	155
Laser Repair In Progress Do Not Enter When Light...	Notice	156
Laser Test Area Do Not Approach This Area When...	Danger	155
Laser Wear Protective Laser Goggles	Danger	155
Leavarse Las Manos Antes De Salir De Este Cuarto	Aviso	56
Lead Hazard Area Wear Respirator Possession Or Use...	Caution	65
Lead Hazard Do Not Enter Work Area Unless Authorized	Caution	65
Lead May Damage Fertility Or The Unborn Child...	Danger	70
Lead Work Area Poison No Smoking Or Eating	Warning	73
Lead Work Area Respirator Required	Danger	70
Lead Work Area. Poison. No Smoking Or Eating	Warning	49
Left	-	171
Left Turn Signal	-	181
Let Us All Be Safety Inspectors Report Unsafe...	Safety First	165
Lets Cut Out The Injuries	-	160
Life Jackets Must Be Worn Beyond This Point	Notice	150
Lifebuoy Picto	-	99
Lifebuoy With Light Picto	-	99
Lifebuoy With Line Picto	-	99
Lifeline Must Be Hooked Up While On Platform	Caution	82
Lifeline Required	Caution	82
Lifeline Required For Entry	Danger	84
Lift Raft Picto	-	99
Like I Do	Think	112
Limited Access Area Authorized Personnel Only	Notice	31
Liquefied Hydrogen Flammable Gas No Smoking No ...	Danger	70
Liquid Nitrogen	Danger	70
Liquid Nitrogen Gloves And Face Shield Required	Caution	146
Liquid Petroleum Gas	Danger	70
Live Steam	Danger	45
Live Steam	Danger	70
Live Wire Overhead	Danger	90
Live Wire Overhead. Contact Will Result In Serious...	Danger	45
Loading And Unloading Zone	-	181
Local Alarm Only Not Connected To Fire Department...	-	106
Lock Out All Power Sources Before Entering Machine	Caution	118
Lock Out Before Maintenance Or Any Operator Adjustment	Caution	118
Lock Out Before Maintenance Or Any Operator Adjustment	Notice	119
Lock Out Before Servicing	Danger	119
Lock Out Before Servicing	-	49
Lock Out Before Servicing	-	119
Lock Out Before Servicing Failure To Lock Out Will...	Danger	45
Lock Out Electrical Equipment Before Performing Repairs	Caution	118
Lock Out Electrical Switches Before Working On ...	Danger	119
Lock Out Electrical Switches Before Working On...	Danger / Peligro	52
Lock Out Equipment Before Entering	Danger	119
Lock Out Equipment Before Entering / Bloquear El...	Danger / Peligro	52
Lock Out Equipment Before Entering Failure To Lock...	Danger	45
Lock Out Equipment Before Servicing. / Bloquear...	Danger / Peligro	52
Lock Out For Safety	Danger	119
Lock Out For Safety	-	119
Lock Out For Safety	Caution	118
Lock Out For Safety Before You Start	Caution	118
Lock Out For Safety Failure To Lock Out May Result ...	Caution	38
Lock Out Here	-	119
Lock Out Power Before Opening Guards Access ...	Caution	118
Lock Out Switches Before Working On Equipment	Warning	119
Lock Valves Before Entering Tanks	Caution	118
Lock-Out For Safety Before You Start / Por Razones...	Caution / Precaucion	51
Lock-Out/Tag-Out Power Before Servicing, Repairing...	Danger	119
Locker With Additional Breathing Apparatus	-	99
Lockout Center	-	114
Lockout Safety Center W/Down Arrow	-	114
Lockout Tagout Center	Safety First	48
Look Out For Cars	Danger	125
Look Out For Contact Hazards And Moving Parts Of ...	Caution	121
Look Out For Crane	Danger	126
Look Out For Fork Lifts	Warning	129
Look Out For Fork Lifts	Danger	45
Look Out For Fork Lifts	Danger	126
Look Out For Forklifts / Cuidado Con Los Montacargas	Caution / Precaucion	50
Look Out For Lift Trucks	Danger	126
Look Out For Lift Trucks	Warning	178
Look Out For Lift Trucks	Danger	126
Look Out For Lift Trucks / Cuidado Con Los Camiones	Danger / Peligro	53
Look Out For Lift Trucks. Accident Will Cause...	Danger	45
Look Out For Powered Industrial Trucks	Caution	176
Look Out For Trucks	Danger	126
Look Up Power Lines Overhead	Caution	88
Look Up. Power Lines Overhead. Serious Injury May...	Caution	38
Low Clearance	Caution	121
Low Clearance	Danger	126
Low Clearance	Warning	129



# Sign Legend Index

BradyID.com/s34

Legend Text	Header	Pg
Low Clearance / Poca Altura	<b>Danger / Peligro</b>	55
Low Clearance Accident Will Result In Serious Injury.	<b>Danger</b>	45
Low Headroom	-	131
Low Headroom	<b>Caution</b>	121
Low Headroom	<b>Danger</b>	126
Low Headroom	<b>Warning</b>	129
Low Headroom Injury May Result.	<b>Caution</b>	38
Low Overhead Clearance	<b>Caution</b>	121
Low Overhead Clearance	<b>Danger</b>	126
Low Overhead Clearance	<b>Caution</b>	38
Low Overhead Clearance	<b>Caution</b>	121
Low Overhead Clearance Accident Will Result In ...	<b>Danger</b>	45
Low Overhead Clearance Injury May Result	<b>Caution</b>	38
Low Pressure Manifold Do Not Connect High-Pressure...	<b>Caution</b>	65
Low-Pressure Manifold Do Not Connect High Pressure...	-	76
Lower Lifeboat Picto	-	99
Lower Rescue Boat Picto	-	99
Lp Gas Storage No Smoking Or Open Flames Within ...	<b>Danger</b>	45
Lp Gas Storage No Smoking Or Open Flames Within...	<b>Danger</b>	70

## M

M.S.D.S.	-	114
Machine Lockout Point	<b>Caution</b>	118
Machine Starts Automatically Keep Hands Away	<b>Caution</b>	121
Magnetic Field In Place	<b>Warning</b>	156
Main Electric Shut-Off	<b>Caution</b>	88
Main Gas Cut Off	<b>Notice</b>	128
Main Office	-	87
Main Power Cut Off	<b>Notice</b>	129
Main Sprinkler Valve	-	106
Maintenance Dept.	-	87
Maintenance Personnel Only	<b>Notice</b>	31
Maintenance Shop	-	87
Make Every Move A Safe One	<b>Think</b>	165
Make It Right The First Time	-	160
Make Quality A Company Wide Commitment	-	160
Make Safety A Daily Habit	-	160
Make Sure All Power Sources Are Locked Out Before...	<b>Caution</b>	118
Make Time For Safety	-	160
Make Your Work Place Safe Before Starting The Job	<b>Safety First</b>	165
Mammography	-	117
Man Picto	-	159
Mandatory Action Caution Prohibition Environmental	-	189
Manguera Para Incendios	-	59
Mantener Cerrada Esta Puerta	<b>Aviso</b>	56
Mantener Las Manos Alejadas	<b>Peligro</b>	54
Mantener Los Cilindros Encadenados	<b>Peligro</b>	54
Material Safety Data Sheets & The Written Hazard...	<b>Notice</b>	72
Material Safety Data Sheets Available Upon Request	<b>Notice</b>	72
Material Safety Data Sheets Available Upon Request...	<b>Notice / Aviso</b>	56
Maximum Height ___ Ft. ___ In.	<b>Caution</b>	121
Maximum Load ___ Lbs.	<b>Caution</b>	121
May Contain Asbestos Do Not Disturb Pipe Insulation...	<b>Danger</b>	70
Meat Wash Only	-	131
Medical Library	-	117
Medical Records	-	117
Meet The Person Most Responsible For Your Safety	-	153
Men	-	63
Men	-	159
Men	-	114
Men / Hombres	-	59
Men / Hombres	-	59
Men Working	-	171
Men Working	<b>Danger</b>	126
Men Working	<b>Warning</b>	129
Men Working Above	<b>Danger</b>	126
Men Working Above	<b>Danger</b>	170
Men Working Above / Hombres Trabajando Arriba	<b>Danger / Peligro</b>	54
Men Working Above Proceed With Caution	<b>Danger</b>	45
Men Working Below	<b>Warning</b>	129
Men Working Below	<b>Danger</b>	126
Men Working Below / Hombres Trabajando Abajo	<b>Danger / Peligro</b>	54
Men Working Do Not Start	<b>Danger</b>	126
Mental Health	-	117
Mercury	-	78
Methanol	-	78
Methyl Ethyl Ketone	-	78
Microwave Frequencies Present	<b>Danger</b>	155
Microwave Hazard In This Area	<b>Notice</b>	156
Microwave In Operation	<b>Caution</b>	155
Microwave In Use / Microondas En Uso	<b>Caution / Precaucion</b>	50
Microwave Oven Could Be Harmful To Persons ...	<b>Caution</b>	155
Microwave Oven In Use	<b>Danger</b>	45

Legend Text	Header	Pg
Microwave Oven In Use	<b>Danger</b>	155
Microwave Oven In Use	<b>Notice</b>	156
Misc. Hazardous Materials 9	-	80
Monitored By Video Camera	<b>Restricted Area</b>	167
Monitored By Video Camera / Area Monitoreada Por...	<b>Restricted Area / Area Restringida</b>	58
More Than One Energy Source	-	119
More Than One Voltage Source	-	119
Motorcycle Parking Only	-	181
Moving Machinery	<b>Danger</b>	126
Moving Machinery / Maquinaria En Movimiento	<b>Danger / Peligro</b>	54
Moving Machinery Do Not Enter	<b>Danger</b>	30
Moving Machinery Do Not Enter / Maquinaria En...	<b>Danger / Peligro</b>	54
Moving Machinery Stay Clear. Accident Will Cause...	<b>Danger</b>	45
Moving Saw Blade May Result In Loss Of Fingers ...	<b>Danger</b>	126
Mowing Ahead	-	171
Mri	-	117
Mri/Pet	-	117
Msds	-	114
Msds	-	115
Msds And The Written Hazardous Communication...	<b>Notice</b>	72
Msds And The Written Hazardous Communication...	<b>Notice / Aviso</b>	56
Msds Info	-	115
Muriatic Acid	-	78
Muster Point	-	98
Muster Point	-	98
Muster Point 1	-	98
Muster Point 2	-	98
Muster Point 3	-	98
Muster Point 4	-	98
Muster Point 5	-	98
Muster Point 6	-	98
Muster Point 7	-	98
Muster Point 8	-	98

## N

N.O.R.M. Naturally Occurring Radioactive Material	<b>Caution</b>	155
N.O.R.M. Naturally Occurring Radioactive Material	<b>Caution</b>	38
Natural Gas	<b>Danger</b>	70
Natural Gas	<b>Danger</b>	45
Natural Gas Pipeline High Pressure Before Digging...	<b>Warning</b>	73
Naturally Occurring Radioactive Material	<b>Caution</b>	155
Neurology	-	117
Never Be Hasty	-	160
New Chemical Storage Only	<b>Danger</b>	70
Nip Point	<b>Danger</b>	126
Nitric Acid	-	78
Nitric Acid	<b>Danger</b>	70
Nitric Acid Improper Contact Will Cause Severe Burns ...	<b>Danger</b>	45
Nitrogen	<b>Danger</b>	70
Nitrogen	<b>Danger</b>	45
Nitrogen Empty Cylinders	-	76
Nitrogen Full Cylinders	-	76
Nitrogen Storage No Smoking No Open Flames	<b>Danger</b>	70
Nitrogen, Liquid	-	78
No Admittance	-	34
No Admittance	<b>Danger</b>	30
No Admittance	<b>Notice</b>	31
No Admittance Apply At Office	<b>Notice</b>	31
No Admittance Authorized Employees Only / Prohibida...	-	60
No Admittance Authorized Persons Only	-	34
No Admittance Authorized Persons Only	-	168
No Admittance Beyond This Point Check With Guard	<b>Security Notice</b>	167
No Admittance Beyond This Point Check With Security	<b>Security Notice</b>	167
No Admittance Employees Only	<b>Notice</b>	32
No Admittance Employees Only	-	168
No Admittance Employees Only	<b>Restricted Area</b>	167
No Admittance Employees Only Vendors & Visitors...	-	34
No Admittance Except For Assigned Employees And...	-	34
No Admittance Except To Employees On Duty	-	168
No Admittance Except To Employees On Duty	<b>Danger</b>	30
No Admittance Please Use Other Door	-	34
No Admittance Ring Bell For Service	-	168
No Admittance Without A Permit	<b>Notice</b>	32
No Admittance Without Authorization	-	168
No Admittance Without Authorization	<b>Danger</b>	30
No Admittance Without Authorization	<b>Restricted Area</b>	167
No Admittance Without Pass From Office	<b>Notice</b>	32
No Admittance Without Security Pass	<b>Security Notice</b>	167
No Alcoholic Beverages Or Drugs Permitted On...	<b>Notice</b>	167
No Beverages Or Food Allowed In This Area	-	134
No Bicycles Skateboards Rollerblades	-	169
No Bull	-	112

# Sign Legend Index

BradyID.com/s34

Legend Text	Header	Pg
No Burning Welding Or Open Flame Without Permission	-	106
No Cell Phones	-	115
No Cell Phones / No Texting While Driving	-	189
No Cellular Phone Or Two Way Radios Allowed	Notice	135
No Cellular Phones	-	135
No Cellular Phone Picto	Security Notice	135
No Cellular Phones	-	135
No Cellular Phones Allowed	Notice	135
No Chemical Storage Allowed In This Area	-	76
No Chemicals In Drain Use Chemical Waste Containers	Caution	65
No Clearance	Danger	126
No Clearance For Man On Car	Danger	126
No Comer Ni Beber En Esta Area	Aviso	57
No Concealed Weapons Allowed On Company Grounds	-	189
No Concealed Weapons Allowed On This Property	-	34
No Dogs Allowed	-	34
No Double Parking	-	181
No Dumping	-	134
No Dumping Violators Will Be Prosecuted	-	169
No Dumping Violators Will Be Prosecuted	-	181
No Eating Or Drinking In This Area	Notice	133
No Eating Or Drinking In This Area / Prohibido...	Notice / Aviso	57
No Eating, Drinking, Or Smoking	-	61
No Entrar	Peligro	55
No Entrar Solo Personal Autorizado	Peligro	55
No Entry	-	94
No Entry By Unauthorized Personnel	-	157
No Entry Picto	-	34
No Entry Unless Authorized	Notice	32
No Entry Unless Authorized	Restricted Area	167
No Entry Unless Authorized	Notice	32
No Es Salida	-	59
No Exit	-	94
No Exit	Notice	91
No Exit	Notice	48
No Exit / No Hay Salida	-	59
No Exit / No Hay Salida	Notice / Aviso	57
No Firearms Allowed On Company Grounds	-	189
No Firearms Allowed On Premises	Notice	32
No Firearms Allowed On Premises / No Se Permiten...	Notice / Aviso	57
No Firearms Allowed On This Property / No Se...	-	59
No Firearms Allowed On This Property / No Se...	Notice / Aviso	57
No Firearms No Knives No Drugs No Alcohol Violators...	-	34
No Firearms Or Weapons Allowed On This Property	-	34
No Flammable Liquids Beyond This Point	Danger	71
No Foil Or Metal In This Machine This Machine Is...	Caution	155
No Food Or Beverage Allowed	-	189
No Food Or Beverage Allowed	-	189
No Food Or Beverage Allowed In This Area	-	189
No Food Or Drink Beyond This Point	Notice	133
No Forklifts Allowed In This Area	-	131
No Fumar	-	59
No Fumar	-	59
No Fumar	Peligro	55
No Fumar, No Producir Llamas Ni Chispas	Peligro	55
No Gasoline Or Fuel In Unauthorized Containers	-	76
No Guns Allowed Beyond This Point	-	169
No High Heel, Open Toe, Open Heel Or Tennis...	-	189
No Idling Diesel-Powered Vehicles Over 5 Tons Act...	-	181
No Idling Turn Your Engines Off And Protect The Air ...	-	181
No Jewelry No Piercings No Exposed Cuts Beyond ...	Notice	142
No Left Turn	-	181
No Lift Trucks	Notice	129
No Lift Trucks Beyond This Point	-	181
No Lift Trucks Beyond This Point	Notice	129
No Loitering	-	34
No Loitering On This Property	-	169
No Loitering Police Take Notice	-	169
No Loitering Soliciting Skateboards Rollerblades	-	169
No Loose Clothing While Operating This Machinery	Danger	126
No Operar Sin Protecciones	Precaucion	51
No Outlet	-	181
No Parking	-	170
No Parking	-	181
No Parking	Notice	177
No Parking	Restricted Area	177
No Parking	-	181
No Parking	Notice	48
No Parking / No Estacionarse	Notice / Aviso	57
No Parking 7Am-7Pm Except Electric Vehicles	-	174
No Parking Always Keep Clear	-	181
No Parking Any Time	-	181
No Parking At Any Time	-	170
No Parking Between Signs	-	181

Legend Text	Header	Pg
No Parking Beyond This Point	-	181
No Parking Beyond This Sign	-	181
No Parking Bus Stop	-	181
No Parking Company Vehicles Only	-	181
No Parking Doctors Only	-	181
No Parking Except Electric Vehicles	-	174
No Parking Except On Shoulder	-	181
No Parking Except Sundays And Holidays	-	181
No Parking Except While Charging	-	174
No Parking Fire Hydrant	-	181
No Parking Fire Lane	-	181
No Parking Fire Lane / No Estacionarse Zona De ...	-	59
No Parking Fire Lane Keep Clear At All Times	-	181
No Parking Fire Lane Police Enforced	-	181
No Parking Fire Station	-	181
No Parking Here To Corner	-	181
No Parking In This Block	-	182
No Parking Keep Area Clear At All Times	-	182
No Parking Loading Zone	-	182
No Parking On Pavement	-	182
No Parking Police Cars	-	182
No Parking School Days	-	182
No Parking Service And Delivery Area	-	182
No Parking Symbol	-	182
No Parking This Side	-	182
No Parking This Space Is Reserved	-	182
No Pedestrian Crossing	-	182
No Pedestrian Traffic	-	182
No Pedestrian Traffic	Danger	126
No Pedestrian Traffic Accident Will Result In...	Danger	45
No Pets	-	34
No Phones Cameras Or Other Electronic Devices...	Notice	167
No Public Restrooms	-	159
No Riders	-	182
No Se Permiten Armas, En Conformidad Con A.R.S...	-	59
No Smoking	-	138
No Smoking	Caution	38
No Smoking	Caution	136
No Smoking	Danger	45
No Smoking	Danger	136
No Smoking	Warning	138
No Smoking	-	111
No Smoking	-	138
No Smoking	Danger	46
No Smoking	Danger	136
No Smoking - No Eating	-	138
No Smoking (Braille)	-	63
No Smoking / No Fumar	-	59
No Smoking / No Fumar	-	59
No Smoking / No Fumar	Danger / Peligro	55
No Smoking Allowed	-	138
No Smoking Allowed In This Building At Any Time...	-	138
No Smoking At Any Time	-	138
No Smoking Battery Charging Emits Hydrogen Gas	Danger	71
No Smoking Beyond This Door	-	139
No Smoking Beyond This Door	Danger	136
No Smoking Beyond This Point	-	139
No Smoking Beyond This Point	Caution	136
No Smoking Beyond This Point	Danger	46
No Smoking Beyond This Point	Danger	136
No Smoking Beyond This Point	Warning	138
No Smoking Beyond This Point	-	139
No Smoking Beyond This Point	Danger	136
No Smoking Beyond This Point, / No Fumar A Partir...	Caution / Precaucion	51
No Smoking Except In Designated Areas	-	139
No Smoking Except In Designated Smoking Areas	Danger	137
No Smoking Flammable Materials	Danger	137
No Smoking In Office Area	-	139
No Smoking In This Area	-	139
No Smoking In This Area	Danger	137
No Smoking In This Area	-	49
No Smoking In This Building	-	139
No Smoking In This Building	Danger	137
No Smoking In This Building By Order Of Government...	-	139
No Smoking In This Building It's The Law	-	139
No Smoking In This Facility	-	139
No Smoking In Trailers And Dock Area	Danger	137
No Smoking Matches Or Open Lights	-	139
No Smoking Matches Or Open Lights	Danger	46
No Smoking Matches Or Open Lights	Danger	137
No Smoking No Flames No Sparks	Danger	137
No Smoking No Open Flames	Caution	136
No Smoking No Open Flames	Oxygen	72
No Smoking No Open Flames No Sparks	Danger	46



# Sign Legend Index

BradyID.com/s34

Sign Legend Index

Legend Text	Header	Pg
No Smoking No Open Flames No Sparks	Danger	137
No Smoking No Open Flames No Sparks	Danger	46
No Smoking No Open Flames No Sparks / No...	Danger / Peligro	55
No Smoking No Open Flames No Water Reactive Materials	Danger	137
No Smoking On Premises	-	139
No Smoking On School Grounds	-	139
No Smoking On Stairway	-	139
No Smoking On These Premises	-	139
No Smoking On This Property	-	140
No Smoking Or E-Cigarettes	Danger	136
No Smoking Or Open Flames	-	140
No Smoking Or Open Lights Within ___ Feet	Danger	137
No Smoking Or Open Lights Within ___ Feet	Danger	46
No Smoking Or Open Lights Within ___ Feet	Danger	137
No Smoking Or Tobacco Products In This Facility	-	140
No Smoking Oxygen In Use	Danger	46
No Smoking Oxygen In Use	Danger	137
No Smoking Picto	-	110
No Smoking Picto	-	138
No Smoking Stop Engine When Refueling	-	182
No Smoking This Area	-	140
No Smoking To Report Violations Call: ___-___-___	-	140
No Smoking Turn Off Engine	Warning	138
No Smoking Turn Off Ignition	Danger	137
No Smoking Under Penalty Of Dismissal	Notice	137
No Smoking Under Penalty Of Law	-	140
No Smoking Unless You're On Fire	Notice	112
No Smoking Violation Will Result In Disciplinary Action	Notice	137
No Smoking Violators Are Subject To Fine. New...	-	140
No Smoking Within ___ Feet	-	140
No Smoking Within 15 Feet Of Building Enterances	Danger	137
No Smoking Within 20 Feet Of Building Enterances	Danger	137
No Smoking Within 50 Feet	-	140
No Smoking Within 50 Feet	Warning	138
No Smoking, Eating Or Drinking In This Area	Warning	49
No Smoking, Matches Or Open Lights	Warning	138
No Smoking.	Danger	46
No Solicitation	-	34
No Solicitation Or Distribution Of Materials...	Notice	32
No Soliciting	Notice	32
No Soliciting	Notice	48
No Soliciting No Loitering No Trespassing Violators...	-	169
No Solicitors Allowed	-	182
No Steps	Caution	121
No Steps	Caution	38
No Stopping Fire Lane	-	182
No Texting While Driving	-	182
No Thoroughfare	Restricted Area	33
No Through Traffic	-	182
No Thru Traffic	-	182
No Tractor Trailers	-	182
No Trespassing	-	34
No Trespassing	-	182
No Trespassing	Caution	28
No Trespassing	Danger	30
No Trespassing	Danger	46
No Trespassing	Notice	32
No Trespassing	Restricted Area	167
No Trespassing	Warning	33
No Trespassing	Warning	49
No Trespassing	Notice	32
No Trespassing	Notice	48
No Trespassing / Prohibido El Paso	Notice / Aviso	57
No Trespassing / Prohibido El Paso	Warning / Advertencia	58
No Trespassing Admittance Limited To Employees And...	-	34
No Trespassing Authorized Personnel Only	Danger	30
No Trespassing Authorized Personnel Only	Danger	46
No Trespassing Construction Area Violators Will Be ...	-	85
No Trespassing On This Property Under Penalty Of ...	Danger	30
No Trespassing On This Property Under Penalty Of ...	Notice	32
No Trespassing Private Road	-	169
No Trespassing Under Penalty Of Law	-	169
No Trespassing Under Penalty Of Law	Restricted Area	167
No Trespassing Under Penalty Of The Law	-	34
No Trespassing Vendors & Visitors Must Register ....	-	169
No Trespassing Violators Will Be Prosecuted	-	34
No Trespassing Violators Will Be Prosecuted	-	182
No Trespassing Violators Will Be Prosecuted /...	-	60
No Truck Drivers Beyond This Point	Notice	177
No Truck Parking	-	182
No Trucks	-	182
No Trucks Or Trailers	-	182
No Trucks Picto	-	177

Legend Text	Header	Pg
No Turkeys Allowed	-	112
No Turn Around	-	182
No U-Turn Picto	-	177
No Unauthorized Personnel Beyond This Point	Restricted Area	33
No Vehicles Beyond This Point	-	182
No Welding Or Open Flames	Danger	100
No Whining	-	112
Nobody Notices What I Do Until I Don't Do It	-	112
Noise Area May Cause Hearing Loss Use Proper ...	Caution	146
Noise Area May Cause Hearing Loss Use Proper ...	Warning	152
Non-Flammable Gas	-	76
Non-Hazardous Materials Only	Notice	72
Non-Permit Confined Space Authorized Personnel Only	Danger	46
Non-Permit Confined Space Authorized Personnel Only	Danger	84
Non-Permit Confined Space Authorized Personnel...	Danger / Peligro	53
Non-Permit Confined Space Keep Out Unless Authorized	Caution	38
Non-Permit Confined Space Keep Out Unless Authorized	Caution	82
Non-Potable Water	Notice	72
Non-Potable Water	Warning	73
Non-Potable Water Do Not Drink	Caution	65
Non-Potable Water Do Not Drink	Danger	71
Non-Potable Water Do Not Drink	Danger	71
Non-Potable Water Do Not Use For Drinking, Washing...	Danger	46
Non-Potable Water Do Not Use For Drinking, Washing...	Danger	71
Non-Potable Water Not For Drinking Or Cooking	Notice	72
Non-Potable Water Not For Drinking Or Cooking Use	Notice	72
Non-Potable Water Not For Drinking Or Cooking Use...	Notice / Aviso	56
Non-Potable Water Not To Be Used For Drinking...	Notice	72
Non-Potable Water. Do Not Drink. / Agua No Potable. ...	Danger / Peligro	52
Non-Potable Water. Do Not Drink. May Result In Injury.	Caution	38
Not A Fire Exit	Warning	91
Not A Fire Exit	Warning	100
Not A Pedestrian Walkway Fork Trucks Only	Danger	31
Not A Step	Caution	121
Not A Step	Caution	38
Not An Emergency Exit	-	106
Not An Entrance	Notice	32
Not An Entrance	Restricted Area	167
Not An Exit	-	94
Not An Exit	Notice	32
Not An Exit	-	94
Not An Exit / No Es Salida	-	59
Not Consumable	-	131
Not Flammable	Notice	100
Not Odorized	-	76
Not Responsible For Cars Or Personal Property Lost...	-	183
Not Responsible For Theft Or Damage To Vehicles	-	169
Not Responsible For Theft Or Damage To Vehicles ...	-	183
Notice All Activities Monitored By Video Camera	-	169
Notice Do Not Throw Smoking Material In Waste...	-	140
Notice No Trespassing Loitering Soliciting On This ...	-	169
Notify Health Physics Prior To Entry	-	157
Nutrition	-	117

## O

OB Clinic	-	117
Office	-	87
Office	-	94
Official Parking Only	-	183
On Bridge	-	183
On The Job Safety Begins Here	-	160
On The Job Safety Begins Here	Think	165
Oncology	-	117
One Lane Closed Ahead	-	171
One Lane Road Ahead	-	171
One Way	-	183
One Way Do Not Enter	-	183
One Way Picto	-	94
Only Authorized Personnel Allowed To Operate Or...	-	131
Only Authorized Personnel Allowed To Operate This ...	Caution	121
Only Authorized Personnel Are Allowed To Enter This...	-	34
Only Authorized Persons To Enter This Area	Notice	32
Only Authorized Persons To Enter This Area	Restricted Area	167
Only Authorized Vehicle Or Foot Traffic Allowed In This Area	-	34
Open Door Slowly	Caution	86
Open Door Slowly / Abrir La Puerta Lentamente	Caution / Precaucion	50
Open Hole	Danger	126
Open Hole Stay Clear. Fall Will Result In Severe...	Danger	46
Open Pit	Caution	121
Open Pit	Danger	126
Open Pit	Danger	170
Open Pit Stay Clear. Fall Will Result In Severe...	Danger	46



# Sign Legend Index

BradyID.com/s34

Legend Text	Header	Pg
Open Slowly	Caution	121
Open Slowly, May Cause Injury.	Caution	38
Open This Valve In The Event Of Fire W/Hard Hat...	-	106
Open Trench	Danger	127
Open Trench Fall Will Result In Severe Injury Or Death.	Danger	46
Operation By Authorized Personnel Only	Danger	127
Operations Dept.	-	87
Operator Must Wear Ear Protection In This Area	Notice	151
Ophthalmology	-	117
Organic Peroxide 5.2	-	80
OSHA Info	-	115
OSHA Regulations Area In Front Of Electrical Panel...	Caution	88
Others Are Depending On You Don't Take Chances	Be Careful	165
Others Are Depending On You. Don't Take Chances	Be Careful	165
Our Aim No Accidents	Think	165
Our Goal No Accidents	-	161
Out	-	87
Out Of Order	-	131
Out Of Service / Fuera De Servicio	Danger / Peligro	54
Out Of Service For Repairs	-	131
Outpatient	-	117
Outpatient Parking Only	-	183
Overhead Conveyor	Danger	127
Overhead Crane Area Proceed With Caution	-	131
Overhead Equipment	Caution	121
Overhead Hoist	Danger	127
Overhead Machinery	Danger	127
Overhead Power Lines	Danger	90
Overhead Power Lines / Lineas De Electricidad Aerea	Danger / Peligro	54
Overhead Power Lines. Contact Will Result In...	Danger	46
Overhead Work	Caution	121
Overhead Work Proceed With Caution. May Cause Injury.	Caution	38
Oxidizer 5.1	-	80
Oxidizer Picto 5.1	-	80
Oxidizer Picto 5.2	-	80
Oxygen 2	-	80
Oxygen Deficient Confined Space	Danger	84
Oxygen Empty Cylinders	-	76
Oxygen Full Cylinders	-	76
Oxygen In Use	-	140
Oxygen, Compressed	-	78

## P

Pacemaker Wearer Do Not Enter This Room Microwave...	Danger	46
Pacemaker Wearer Do Not Enter This Room...	Danger	155
Pacemaker Wearers Do Not Proceed Through Metal...	-	157
Paint Vault	-	77
Paper Only	-	158
Parallel Parking	-	183
Paramedic Parking Only	-	183
Park At Angle	-	183
Park At Your Own Risk	-	183
Park At Your Own Risk Company Not Responsible For...	-	169
Park In Assigned Spaced Only	-	183
Parking	-	173
Parking \$50 To \$300 Fine	-	173
Parking By Disabled Permit Only	-	173
Parking Facilities Under Camera Surveillance And...	Notice	177
Parking For Customers Only	-	183
Parking Lot May Be Slippery When Icy Or Wet ...	Caution	176
Parking Lot May Be Slippery When Icy Or Wet...	Caution	38
Parking Lot Rules No Firearms No Knives No Drugs...	-	178
Parking Permit Required	-	173
Parking Permits Are Required In This Area...	Security Notice	167
Parking Van Accessible	-	173
Parking With D.M.V. Disabled Permit Only. Violators...	-	173
Passage To This Fire Hose Must Be Kept Clear	Notice	133
Pathology	-	117
Ped Xing	-	183
Pedestrian	-	179
Pedestrian Crossing Ahead	-	183
Pedestrian School Crossing	-	178
Pedestrian Traffic Only	-	110
Pedestrian Traffic Only	-	131
Pedestrian Traffic Only	-	111
Pedestrians And Bicycles Prohibited	-	183
Pediatrics	-	117
People Working	Caution	122
People Working Above	Danger	127
Permission To Use Scaffold Shall Be Obtained From...	Warning	85
Permit Parking Only Lot Is Patrolled	-	183
Permit Parking Only Violators Will Be Towed Away...	-	183

Legend Text	Header	Pg
Permit Required Confined Space Do Not Enter /...	Danger / Peligro	55
Permit-Required Confined Space Do Not Enter	Danger	84
Personal Eyewash	Safety First	108
Personal Eyewash Keep Area Clean	-	109
Personal Protection Required In This Area	Notice	151
Personal Protective Clothing Is To Be Worn At All...	Caution	65
Personal Protective Equipment Is Provided Use It!	-	153
Personal Protective Equipment Required Beyond ...	Caution	146
Personal Protective Equipment Stored Here	-	153
Persons Not Assigned To This Area Must Obtain...	Restricted Area	33
Pesticide Storage Area	Warning	73
Pesticide Storage Area All Unauthorized Persons...	Danger	71
Pesticide Storage Authorized Personnel Only	Danger	31
Pesticides	Caution	65
Pesticides In Use Do Not Enter	Danger	71
PET	-	117
Pg Iii 6	-	80
Pharmacy	-	117
Phenol	-	78
Phone	-	115
Phosphoric Acid	-	78
Photography Is Not Allowed Unless Authorized	-	189
Physical Therapy	-	117
Physician Parking Only	-	183
Pick-Up And Drop-Off Only No Parking	-	183
Pick-Up And Drop-Off Only No Parking	-	183
Pinch Point	Warning	130
Pinch Point	-	131
Pinch Point Keep Hands Clear	Caution	38
Pinch Point Keep Hands Clear Moderate Injury...	Caution	39
Pinch Point Watch Your Hands	Danger	127
Pinch Point Watch Your Hands Keep Hands Clear...	Danger	46
Pinch Points / Punto De Agarre	Danger / Peligro	55
Pinch Points Watch Your Hands	Danger	46
Pinch Points Watch Your Hands. Serious Injury Will Result	Danger	46
Pitch In Keep This Place Clean	-	134
Pitch In!	-	134
Pitch In! Help Keep Our Plant Clean!	-	158
Pitch In! Put Trash In Its Place	-	134
Pitch In! Put Trash In Its Place	-	135
Place All Refuse In Can	-	135
Place Cigarettes, Cigar Butts And Ashes In Receptacles	Notice	133
Play It Safe	-	161
Please Do Not Litter / Favor De No Tirar Basura	-	59
Please Do Not Spit On The Floor	Safety First	133
Please Excuse Our Appearance We Are Remodeling	Notice	85
Please Excuse Our Appearance While We're Under ...	-	85
Please Extinguish Before Entering	-	140
Please Flush After Each Use / Favor De Jalar La...	-	59
Please Keep Door Closed At All Times	-	34
Please Keep This Door Closed	-	34
Please No Smoking In This Area	-	140
Please Ring Bell	Notice	177
Please Turn Out Lights When Not In Use	Notice	156
Please Wash Hands Before Returning To Work	-	159
Please Wear Your Seat Belt	-	183
Please Wipe Your Feet Upon Entering	Notice	133
Please.... Deposit All Sanitary Napkins In Container...	-	142
Please.... Do Not Throw Rubbish In Urinals	-	142
Please.... Flush After Using	-	142
Please... Don't Take Food That Doesn't Belong To You	-	135
Please...Keep Off The Grass	-	34
Poca Altura	Peligro	55
Poison	Danger	71
Poison / Veneno	Danger / Peligro	56
Poison / Veneno	Danger / Peligro	56
Poison 6	-	80
Poison Gas 2	-	80
Poison Keep Out	Danger	71
Poison Picto	-	77
Poison Picto 2	-	80
Poison Picto 6	-	80
Poison Storage Area All Unauthorized Persons Keep...	Danger	71
Poison Storage Area All Unauthorized Persons Keep...	Danger / Peligro	52
Poisonous Gas Hydrogen Sulfide	Danger	71
Poisonous Gas Hydrogen Sulfide	Danger	71
Poisonous Gas Storage	Danger	71
Poisonous Gas. Hydrogen Sulfide. Breathing Will...	Danger	46
Positively No Admittance Except To Employees...	-	34
Positively No Smoking	-	140
Positively No Smoking	Danger	137
Positively No Smoking Allowed On These Premises	Notice	137
Positively No Smoking Beyond This Point	Safety First	137



# Sign Legend Index

BradyID.com/s34

Legend Text	Header	Pg
Possible Hydrogen Sulfide Gas Present	Caution	65
Potassium Hydroxide	-	78
Potassium Perchlorate	-	78
Potassium Permanganate	-	78
Potential Biohazard Present	Caution	61
PPE Required	Caution	146
PPE Required Hard Hat Hearing Protection Safety Shoes	Caution	146
PPE Required Hard Hat Safety Glasses Fr Suit	Caution	146
PPE Required Hard Hat Safety Glasses Hearing...	Caution	146
PPE Required Hard Hat Safety Glasses Hearing...	Caution	146
PPE Required Hard Hat Safety Glasses Hearing...	Caution	146
PPE Required Hard Hat Safety Glasses Safety Shoes	Caution	146
PPE Required Safety Glasses Hearing Protection ...	Caution	146
Practice Good Housekeeping A Place For Everything...	-	135
Pregnant Women Should Not Enter	Caution	65
Prevent Static Spark Discharge Use Grounding Devices	Caution	65
Prevent Static Spark Discharge. Use Grounding Devices	Caution	39
Primary Escape Route	-	99
Private Drive	-	183
Private Keep Out	-	34
Private No Trespassing	-	34
Private No Trespassing	Restricted Area	167
Private Parking Violators Will Be Towed Away At...	-	183
Private Property Authorized Personnel Only	-	34
Private Property Keep Out	-	34
Private Property Keep Out	Notice	32
Private Property Keep Out	Security Notice	167
Private Property Keep Out / Prohibido El Paso ...	Notice / Aviso	57
Private Property No Dumping	-	35
Private Property No Hunting Fishing Trespassing	-	35
Private Property No Hunting No Trespassing	-	35
Private Property No Hunting Or Trespassing Allowed	-	35
Private Property No Hunting Or Trespassing Allowed...	-	60
Private Property No Loitering Soliciting Skateboards...	-	169
Private Property No Parking... Etc	-	183
Private Property No Skateboards Bicycles Dogs Loitering	-	35
Private Property No Soliciting Loitering Trespassing	-	35
Private Property No Trespassing	-	35
Private Property No Trespassing	-	183
Private Property No Trespassing Loitering	-	35
Private Property No Trespassing Violators Will Be ...	-	169
Private Property No Trespassing Violators Will Be...	-	60
Private Property No Unauthorized Parking	-	183
Private Property Trespassers Will Be Prosecuted	Security Notice	167
Private Property Trespassers Will Be Prosecuted...	-	35
Private Property Unauthorized Persons Prohibited...	-	35
Private Property Violators Will Be Prosecuted	Notice	32
Private Road	-	183
Private Road Do Not Enter	-	35
Private Road No Thru Traffic	-	184
Private Vehicles Are Not Permitted To Park On Site	Notice	170
Problems Next Office	Notice	112
Production Area All Through Traffic Use Designated D2762	-	111
Production Area. All Through Traffic Use Designated...	-	110
Production Dept.	-	87
Prohibido El Paso	Advertencia	58
Prohibido El Paso	Aviso	57
Prohibido El Paso A Personal No Autorizado	Area Restringida	58
Promote Safety Through Good Housekeeping	-	135
Propane	Warning	73
Propane Cylinders	Danger	71
Propane Cylinders Handle With Care	Danger	46
Propane Gas	-	78
Propane Gas	Danger	71
Propane Gas Flammable	Danger	46
Proper Hand Protection Is Required For All Tasks...	-	188
Protect Your Eyes Wear Safety Glasses	-	154
Protective Clothing Must Be Worn In This Area	-	154
Protective Clothing Picto	-	154
Protective Clothing Required In This Area	Caution	146
Protective Clothing Required In This Area	Danger	149
Protective Clothing Required In This Area	Notice	151
Protective Equipment Is Available See Your Supervisor	Safety First	152
Protective Equipment Must Be Worn In This Area At All...	Danger	149
Protective Equipment Required Affix Pictograms Here	Caution	146
Protective Wear Required In This Area	Caution	40
Pull	-	94
Pull To Open W/Right Up Arrow Picto	-	94
Push	-	94
Push Bar To Open	-	94
Push To Open W/Right Up Arrow Picto	-	94
Put Things In Their Proper Places-And You Will Find...	Please	133
Put Tools Back In Their Proper Place	Notice	133
Put Tools Back In Their Proper Place	Safety First	129

Legend Text	Header	Pg
<b>Q</b>		
Quality - Only Your Best Will Do	-	161
Quality Is Our Most Important Product	-	131
Quarantine Area	Caution	65
<b>R</b>		
Radiation	Danger	156
Radiation Area	-	111
Radiation Area	Caution	39
Radiation Area Authorized Personnel Only / Area...	Caution / Precaucion	50
Radiation Caution Lock Out Radiation Source Before...	-	157
Radiation Hazard	-	157
Radiation High Radiation Area Personnel Monitoring Required	-	157
Radiation Radioactive Waste Prohibited Down Drain	-	157
Radiation Radiologically Controlled Area Radiological...	-	157
Radiation Restricted Area	-	157
Radiation/Contamination Area	-	157
Radio Frequency Fields No Trespassing	Notice	156
Radioactive 7	-	80
Radioactive Equipment In This Area	Caution	155
Radioactive Materials Area	-	157
Radiology	-	117
Rail Car Wheels Must Be Chocked	Caution	176
Railroad Crossing Picto	-	178
Railroad Danger Crossing	-	184
Raw And Cooked Foods Must Not Be Stored Together	-	131
Rcra Accumulation Area	-	77
Read Instructions Before Operating	Caution	122
Receiving	-	184
Receiving Department	-	184
Receiving Hours __Am- Pm	-	184
Receiving Picto	-	94
Recyclable Aluminum Cans Only	-	158
Recyclable Cans Only	-	158
Recyclable Cans Only	-	158
Recyclable Metals Only	-	158
Recyclable Metals Only	-	158
Recyclable Paper Only	-	158
Recyclable Plastic Only	-	158
Recyclable Save Our Resources Aluminum	-	158
Recyclable Save Our Resources Cardboard	-	158
Recyclable Save Our Resources Glass	-	158
Recyclable Save Our Resources Paper	-	158
Recyclable Save Our Resources Plastic	-	158
Recyclable Waste Only	-	158
Recycle / Recicle	-	60
Recycle Symbol	-	158
Registration	-	117
Remember The Next Inspector Is Our Customer	-	131
Remove All Doubt Lock It Out	-	119
Report All Accidents	Safety First	165
Report All Accidents No Matter How Small To Your Foreman	Safety First	108
Report All Accidents To Your Supervisor Immediately	-	109
Report All Injuries At Once	Notice	48
Report All Injuries At Once	Notice	107
Report All Injuries No Matter How Slight To First Aid Station	Safety First	108
Report All Injuries Or Unsafe Conditions Immediately	-	188
Report All Injuries To Your Supervisor	Think	108
Report All Unsafe Conditions To Your Foreman	Safety First	165
Requirement For Entry Shoe Covers Boots Coveralls...	-	157
Reserved For Customers	-	184
Reserved For Electric Vehicle	-	174
Reserved For Faculty	-	184
Reserved For New And Expecting Mothers	-	184
Reserved For Physicians	-	184
Reserved For School Maintenance Vehicles	-	184
Reserved For Security	-	184
Reserved For Service And Delivery	-	184
Reserved For Visitors Only	-	184
Reserved For World's Greatest Dad	-	184
Reserved Handicapped	-	173
Reserved Parking	-	173
Reserved Parking \$250 Fine	-	173
Reserved Parking \$50 Fine 1St Offense Parking...	-	173
Reserved Parking Authorized Personnel Only	-	184
Reserved Parking Handicap Plate Or Permit Only	-	173
Reserved Parking Maximum Fine Of \$100 For Use By...	-	173
Reserved Parking Placard Required	-	173
Reserved Parking Vehicles With Vet Or Dis Plates...	-	173
Reserved Parking Violators Towed Away At Vehicle...	-	184

# Sign Legend Index

BradyID.com/s34

Legend Text	Header	Pg
Resident Parking Only	-	184
Respirator Picto	-	154
Respirator Required	Caution	146
Respirator Required	Danger	149
Respirator Required In This Area	Danger	149
Respirator Required While Painting Or Solvent Cleaning	Caution	146
Respirator Storage	-	135
Respirators Are Required At All Times	-	188
Respirators Are Required In This Area	-	188
Respirators Must Be Worn In This Area	Caution	146
Respirators Must Be Worn In This Area	Notice	151
Respirators Must Be Worn In This Area	Caution	39
Respirators Required Beyond This Point	Danger	149
Respirators Required In This Area	Notice	151
Respirators Required In This Area / Uso Obligatorio...	Caution / Precaucion	51
Respiratory	-	117
Respiratory Protection Required	-	157
Rest Rooms	-	115
Rest Rooms	-	159
Restricted Are Keep Out	-	169
Restricted Area	-	35
Restricted Area	Caution	28
Restricted Area	Danger	31
Restricted Area	Danger	46
Restricted Area	Notice	32
Restricted Area All Persons Must Have Permission...	-	35
Restricted Area Authorized Employees Only	Warning	33
Restricted Area Authorized Personnel Only	-	35
Restricted Area Authorized Personnel Only	Notice	32
Restricted Area Authorized Personnel Only	Security Notice	168
Restricted Area Authorized Personnel Only / Area...	Notice / Aviso	56
Restricted Area Get Permission Before Entering	-	169
Restricted Area Keep Out	Notice	32
Restricted Area No Smoking	-	140
Restricted Area No Smoking At Any Time	Danger	137
Restricted Area No Smoking At Any Time	Danger	137
Restroom	-	159
Restroom (Braille)	-	63
Restroom Being Cleaned	Do Not Enter	142
Restrooms	-	159
Restroom Closed For Cleaning	-	133
Reward For Information Leading To The Arrest And...	-	169
Right	-	171
Right Arrow Picto	-	99
Right Lane Closed Ahead	-	171
Right Shoulder Closed	-	171
Right To Know Info	-	115
Right To Know Information Available In This Office	Notice	72
Right To Know Information Available In This Office...	Notice / Aviso	56
Right To Know Station	-	77
Ring Bell For Service	-	35
Road Closed Ahead	-	171
Road Work Ahead	-	171
Roadconst_Accessory	-	171
Robot In Operation	Danger	127
Robot Moves Without Warning Keep Away	Danger	127
Robot Operating Area Do Not Enter Authorized Persons...	Caution	28
Robotic Area Authorized Personnel Only	Danger	31
Rotating Machinery	Danger	127
Rotating Machinery Proceed With Caution Or Severe...	Danger	47
Rush Job Calendar	-	112
<b>S</b>		
Safe Floor Load Limit Not To Exceed __ Lbs Per Sq Ft	Notice	133
Safety & Quality	-	161
Safety & Quality #1 Priorities!	-	161
Safety = Success	-	161
Safety And Quality #1 Prioities	-	161
Safety Belts Required	Danger	84
Safety Belts Required In This Area	Danger	84
Safety Boots Picto	-	154
Safety Dept.	-	87
Safety Equipment Stored Here	Notice	151
Safety First	-	175
Safety First Wear Personal Protective Equipment	Think	152
Safety Footwear Is Required At All Times	-	188
Safety Footwear Is Required In This Area	-	189
Safety Glasses	-	115
Safety Glasses And Hard Hats Required In This Area	Danger	149
Safety Glasses And Safety Shoes Required In This Area	Notice	151
Safety Glasses Must Be Worn At All Times	-	189
Safety Glasses Must Be Worn At All Times	Caution	146
Safety Glasses Must Be Worn In This Area	-	189

Legend Text	Header	Pg
Safety Glasses Must Be Worn When Using Compressed Air	-	154
Safety Glasses Must Be Worn With Face Shield	Notice	151
Safety Glasses Required	-	111
Safety Glasses Required	-	110
Safety Glasses Required Beyond This Point	Caution	147
Safety Glasses Required Beyond This Point	Caution	170
Safety Glasses Required Beyond This Point	Notice	151
Safety Glasses Required Beyond This Point	Notice	48
Safety Glasses Required Beyond This Point / Uso...	Notice / Aviso	57
Safety Glasses Required In This Area	Caution	147
Safety Glasses Required In This Area	Danger	149
Safety Glasses Required In This Area	Notice	151
Safety Glasses Required In This Area	Safety First	152
Safety Glasses Required In This Area	Danger	149
Safety Glasses Required In This Area	Notice	151
Safety Glasses Required In This Area / Uso...	Caution / Precaucion	51
Safety Glasses Required Shoes And Hard Hats Required...	Safety First	152
Safety Glasses With Clear Lenses And Side Shields...	-	189
Safety Glasses With Side Shields Must Be Worn In ...	Caution	147
Safety Glasses, Safety Shoes And Hard Hats Required...	Notice	151
Safety Gloves Are Required At All Times	-	189
Safety Gloves Are Required In This Area	-	189
Safety Goggles Required	-	111
Safety Goggles Required	-	110
Safety Goggles Required In This Area	Caution	147
Safety Harness Required	Danger	84
Safety Has No Quitting Time	-	161
Safety Has No Quitting Time	-	166
Safety Is Everyone's Job	-	161
Safety Is Job #1	-	161
Safety Is Like Clockwork	-	161
Safety Is Your Responsibility	-	161
Safety Never Hurts	-	161
Safety Now Means No Accidents Later	-	161
Safety Protects People Quality Protects Jobs	-	161
Safety Shoes Must Be Worn	Warning	152
Safety Shoes Must Be Worn In This Area	Danger	149
Safety Shoes Picto	-	154
Safety Shoes Required	Caution	147
Safety Shoes Required / Uso Obligatorio De Calzado ...	Caution / Precaucion	51
Safety Shoes Required In This Area	Notice	151
Safety Shoes Required In This Area	Danger	47
Safety Shower	-	109
Safety Shower	-	111
Safety Shower	-	109
Safety Shower	-	110
Safety Shower	-	115
Safety Shower And Eye Wash Station	Safety First	108
Safety Shower Keep Area Clear	Emergency	48
Safety Starts With You!	-	161
Safety Teamwork	-	161
Safety Training Mandatory Do Not Operate This...	Caution	122
Safety... Work Safely	Think	165
Safety...Work Safely	Think	165
Safety Harness Required	Danger	84
Salida	-	60
Satellite Storage Area	-	77
Save Energy Close Doors When Not In Use	Notice	156
Save Your Eyes Wear Eye Protection	Notice	151
Scaffold Incomplete Do Not Use	Danger	170
Secure All Tanks Chain Cylinders	Caution	65
Secure All Tanks. Chain Cylinders.	Caution	39
Security Alarm Will Sound If Door Is Opened	Notice	32
Security Alarm Will Sound If Door Is Opened	Restricted Area	167
Security Alarm Will Sound If Door Is Opened	Warning	86
Security Badges Must Be Worn At All Times	Security Notice	168
Security Notice Entering This Facility Is Deemed...	-	169
Security Notice Marsec I Security Measures In Effect	-	169
Segregate Waste And Recycle In Appropriate Containers	-	189
Severe Weather Shelter	-	94
Severe Weather Shelter Area	-	115
Severe Weather Shelter Area W/Picto And Left Arrow	-	94
Severe Weather Shelter Area W/Picto And Right Arrow	-	94
Severe Weather Shelter Area W/Tornado Picto	-	94
Sewage Water No Drinking, Fishing Or Swimming	Danger	71
Share The Road	-	184
Sharp Objects Gloves Required	Caution	147
Shipping	-	94
Shipping	-	184
Shipping & Receiving	-	184
Shipping And Receiving	-	184
Shipping Department	-	184
Shoe Covers Required	Notice	151
Shorts, Sleeveless Shirts And Un-Tucked Shirts Are...	-	189



# Sign Legend Index

BradyID.com/s34

Legend Text	Header	Pg
Shoulder Work Ahead	-	171
Shower Station	-	109
Shower Station	<b>Safety First</b>	108
Shower Station Emergency Use Only	-	109
Siamese Connection For Fire Dept.	-	106
Side Shield Safety Glasses Required In This Area	<b>Notice</b>	151
Sidewalk Closed	-	184
Slide To Open	-	94
Slippery Floor	<b>Be Careful</b>	143
Slippery Floor	<b>Caution</b>	122
Slippery Floor	<b>Warning</b>	130
Slippery Floor	<b>Caution</b>	39
Slippery Floor	<b>Caution</b>	122
Slippery Floor Falls May Result In Injury	<b>Caution</b>	39
Slippery Trip Hazard	<b>Caution</b>	122
Slippery When Wet	<b>Caution</b>	122
Slippery When Wet	<b>Notice</b>	129
Slippery When Wet	<b>Caution</b>	122
Slippery When Wet / Resbaloso Cuando Esta Mojado	<b>Caution / Precaucion</b>	51
Slippery When Wet Falls May Result In Injury	<b>Caution</b>	39
Slow	-	184
Slow Blind Corner Proceed With Caution	-	184
Slow Children	-	185
Slow Children Playing	-	185
Slow Dangerous Intersection	-	185
Slow Down Pedestrian Traffic	<b>Caution</b>	176
Slow Down Pedestrian Traffic Accident May Result...	<b>Caution</b>	39
Slow High Traffic Area	-	185
Slow Moving Vehicle Sign	-	192
Slow Proceed With Caution	-	185
Slow Sound Horn	<b>Caution</b>	176
Slow Sound Horn To Avoid Injury	<b>Caution</b>	39
Slow Speed Bump	-	185
Smoke Barrier Please Keep Closed	-	106
Smoking Allowed In This Area	<b>Notice</b>	137
Smoking In Designated Areas Only	-	140
Smoking In Elevator Prohibited	-	140
Smoking Is Prohibited Except In Designated Areas	-	140
Smoking Lounge	-	140
Smoking Permitted	-	140
Smoking Permitted In This Area	-	141
Smoking Permitted In This Area	<b>Notice</b>	137
Smoking Prohibited Except In Designated Areas	-	141
Smoking Prohibited In This Area	-	141
Smoking Will Result In Disciplinary Action	-	141
Social Services	-	117
Sodium Hydroxide	-	78
Sodium Hydroxide	<b>Danger</b>	71
Sodium Hypochlorite	<b>Danger</b>	71
Sodium Hypochlorite Chemical Information	-	77
Solo Empleados	<b>Aviso</b>	57
Solo Personal Autorizado	<b>Aviso</b>	57
Sorry, We're Closed	-	35
Sound Horn Before Entering	<b>Notice</b>	177
Sound Horn Proceed Slowly	<b>Caution</b>	176
Sound Horn Proceed Slowly / Toque La Bocina Proceda...	-	60
Sound Horn Proceed Slowly, Accident May Cause Injury.	<b>Caution</b>	39
Space Or Group Of Spaces Monitored By Heat Detectors	-	99
Space Protected By Halon	-	99
Speed Bump Ahead	-	185
Speed Limit 10 Mph	-	185
Speed Limit 15 Mph	-	185
Speed Limit 20 Mph	-	185
Speed Limit 25 Mph	-	185
Speed Limit 5 Mph	-	185
Spill Control Station	-	77
Spill Response Equipment	-	115
Spill Response Equipment	<b>Emergency</b>	48
Spill Sorbent Storage	-	77
Spill Station	-	115
Spill-Kit Station	-	77
Spitting Is Unlawful Unsanitary Unhealthy Dangerous...	-	142
Spontaneously Combustible 4	-	80
Spray Paint Booth Paint Fumes May Be Present	-	77
Sprinkler Control Valve	-	106
Sprinkler Control Valve	-	106
Sprinkler Control Valve W/Hard Hat And Fire Picto	-	106
Sprinkler Drain Valve	-	106
Sprinkler Fire Alarm	-	106
Sprinkler Stop Valve W/Hard Hat And Fire Picto	-	106
Sprinkler Valve	-	94
Sprinkler Valve	-	106
Sprinkler Valve Do Not Close Unless Authorized	-	106
Sprinkler Valve Keep Open	-	106

Legend Text	Header	Pg
Staff Parking Only	-	185
Stairs	-	94
Stairs	-	95
Stairs To Fire Exit	-	95
Stairway	<b>Caution</b>	122
Stairway (Braille)	-	63
Stand Clear Of Door	<b>Caution</b>	86
Stand Clear Of Door	<b>Caution</b>	122
Stand Clear Of Swing Radius	<b>Caution</b>	122
Standpipe	-	106
Standpipe At Other Stairs	-	106
Standpipe For Fire Department Use Only	-	106
Start Water Spray Picto	-	99
Starts Automatically	<b>Danger</b>	127
Starts Automatically Keep Hands Clear Severe...	<b>Danger</b>	47
Starts Automatically Keep Hands Clear	<b>Danger</b>	127
Starts Automatically Proceed With Caution, Death...	<b>Danger</b>	47
Static Control Area	<b>Caution</b>	88
Static Sensitive Devices: Do Not Enter Without...	<b>Caution</b>	88
Stay Alert	-	161
Stay Alert And Yield To Forklift Traffic	-	189
Stay Alert Don't Get Hurt	<b>Be Careful</b>	165
Stay Back _____ Feet	<b>Caution</b>	122
Stay Clear	<b>Caution</b>	28
Stay Clear	<b>Danger</b>	47
Stay Clear	<b>Danger</b>	127
Stay Clear / No Obstruir El Paso	<b>Danger / Peligro</b>	55
Stay Clear Automatic Equipment May Start At Anytime	<b>Caution</b>	39
Stay Clear Automatic Start Equipment	<b>Danger</b>	47
Stay Clear Of Moving Conveyors	<b>Danger</b>	127
Stay Clear Of Swing Radius	<b>Danger</b>	127
Stay Clear Of Swing Radius Moving Equipment Will...	<b>Danger</b>	47
Stealing Will Lead To Arrest And Prosecution	<b>Warning</b>	168
Steel Toe Shoes Required In This Area	<b>Notice</b>	151
Steel-Toe Safety Footwear Is Required In All Areas...	-	189
Step Down	<b>Caution</b>	122
Step Down	<b>Warning</b>	130
Step Up	<b>Caution</b>	122
Step Up	<b>Warning</b>	130
Stop	-	110
Stop	-	111
Stop	-	175
Stop	-	185
Stop / Pare	-	60
Stop Ahead	-	185
Stop All Visitors Must Report To Main Office	-	185
Stop Authorized Personnel Only Beyond This Point	-	185
Stop Car Connected	-	175
Stop Check In Here	-	169
Stop Check With Guard Before Entering Plant	-	185
Stop Check With Guard Before Proceeding	-	185
Stop Crew At Work	-	175
Stop Ear Protection Required In This Area	-	154
Stop Employees Working	-	175
Stop Engine No Smoking	-	141
Stop Exit Only Do Not Enter	-	185
Stop Fires Before They Start Think Fire Safety	-	106
Stop For Pedestrians In Crosswalk	-	185
Stop For Vehicle Check	-	185
Stop Hard Hat Required Beyond This Point	-	185
Stop Hard Hat Required Beyond This Point	-	185
Stop Hearing Protection & Safety Glasses Must Be...	-	154
Stop Hearing Protection Required In This Area	-	185
Stop Here When Flashing	-	186
Stop Look Before Exiting	-	186
Stop Look Out For Forklifts	-	186
Stop Machine Before Removing Jams	<b>Caution</b>	122
Stop Men At Work	-	186
Stop No Pedestrians Fork Trucks Only	-	186
Stop Pedestrian Crossing	-	186
Stop Pedestrian Crosswalk	-	186
Stop Personal Protective Equipment Required Beyond ...	-	186
Stop Proceed Slowly	-	186
Stop Proceed Slowly	<b>Danger</b>	127
Stop Proceed With Caution	-	186
Stop Safety Glasses Required Beyond This Point	-	186
Stop Sound Horn And Proceed With Caution	-	186
Stop Sound Horn Proceed Slowly	-	175
Stop Tank Car Connected	-	175
Stop Think Observe Proceed	-	186
Stop This Machinery Before Oiling, Wiping Or Repairing	-	131
Stop Vendors And Visitors. Must Sign In At Guardhouse	-	35
Stop Your Hand Is Near A Pinch Point	-	131
Stop Your Motor	<b>No Smoking</b>	137

# Sign Legend Index

BradyID.com/s34

Legend Text	Header	Pg
Stop Your Motor	<b>No Smoking</b>	137
Storage Area Flammable Material	<b>Danger</b>	100
Storage Area No Smoking Or Open Flames	<b>Warning</b>	138
Storage Not Permitted In This Area	<b>Warning</b>	49
Storage Not Permitted In This Area	<b>Warning</b>	73
Storage Room Not An Exit	-	95
Store Full Gas Cylinders Here	<b>Notice</b>	72
Stretcher	-	109
Striped (Black/Orange) Traffic Sign	-	178
Student Parking Only	-	186
Sudden Stops Or Turns May Cause Loads To Shift Or Fall	<b>Caution</b>	176
Sulfuric Acid	<b>Danger</b>	71
Sulfuric Acid Wear Goggles And Protective Clothing	<b>Danger</b>	71
Sulfuric Acid. Contact Will Result In Severe Burns Or Death.	<b>Danger</b>	47
Sulfuric Acid. Wear Goggles And Protective Clothing	<b>Danger</b>	47
Surgery	-	117
Sustancias Quimicas Peligrosas	<b>Peligro</b>	55

## T

Taxi Lane	-	186
Teamwork The Necessary Ingredient For Safety...	-	161
Teamwork There Is No 'I' In Teamwork	-	162
Telephone	-	95
Tenant Parking Only	-	186
Thank You For Not Smoking	-	141
Thank You For Working Safely	-	162
Thank You...I Appreciate Your Not Smoking Here	-	141
The Best Safety Device Is A Careful Worker	-	166
The Placement Of Hazardous Waste In This Container...	<b>Caution</b>	65
The Safe Way Is The Best Way	<b>Be Careful</b>	165
The Safe Way Is The Best Way	<b>Think</b>	166
The Safe Way Is The Only Way	-	162
The Use Of Cameras Or Video Equipment Is Prohibited	-	169
The Use Of Tobacco Products In This Facility Is Prohibited	-	141
There Is No Substitute For Safety	<b>Think</b>	166
These Doors Close Automatically	<b>Caution</b>	28
These Doors Must Be Kept Closed	<b>Caution</b>	86
These Premises Are Alarmed	<b>Security Notice</b>	168
These Premises Protected By Closed Circuit Tv	<b>Notice</b>	32
Think And Work Safely	-	162
Think And Work Safely (Bilingual)	-	162
Think Quality	-	162
Think Safety	-	162
Think Safety	-	166
This Area Closed Off	<b>Caution</b>	28
This Area Is Under 24 Hour Tv Surveillance...	<b>Notice</b>	167
This Area Is Under 24 Hour Tv Surveillance...	<b>Notice / Aviso</b>	56
This Area Is Under 24 Hour Tv Surveillance...	-	169
This Area Patrolled By Attack Dogs	<b>Warning</b>	168
This Area Protected By Halon 1301 Fire Extinguishing ...	-	106
This Company Has Worked [#] Days Without A Disabling...	-	166
This Company Has Worked [#] Days Without A Lost...	-	166
This Company Promotes A Drug Free Environment	-	166
This Company Promotes A Smoke Free Environment	-	166
This Department Has Worked [#] Days Without A Lost...	-	166
This Department Has Worked [#] Days Without A...	-	166
This Device Controlled By An Energy Management...	-	119
This Disconnect Does Not Remove All Power From Panel	-	119
This Disconnect Does Not Remove All Power From Panel	<b>Warning</b>	119
This Door For Emergency Exit Only	-	95
This Door Is Alarmed	<b>Security Notice</b>	168
This Door Must Be Kept Closed	-	87
This Door Must Be Kept Closed	<b>Caution</b>	86
This Door To Remain Unlocked During Business Hours	-	87
This Door To Remain Unlocked During Business Hours	<b>Notice</b>	86
This Door To Remain Unlocked During Working Hours	-	87
This Elevator Is For Freight Only Not For Passengers	<b>Notice</b>	129
This Elevator Maximum Capacity _____ Lbs.	-	131
This Enclosure Contains High Voltage Electrical...	<b>Danger</b>	31
This Enclosure Contains High Voltage Electrical...	<b>Danger</b>	47
This Equipment Has Been Locked Out	<b>Caution</b>	118
This Equipment Is Supplied With Two Electrical Services	<b>Danger</b>	47
This Equipment Is Supplied With Two Electrical Services	<b>Danger</b>	127
This Equipment Must Be Locked Out When Work Is...	<b>Caution</b>	118
This Equipment Operates From Remote Control	<b>Danger</b>	127
This Equipment Starts Automatically	-	131
This Equipment Starts Automatically	<b>Danger</b>	127
This Equipment Starts Automatically	<b>Danger</b>	47
This Equipment Starts Automatically / Este Equipo...	<b>Danger / Peligro</b>	53
This Equipment Starts Automatically Stay Clear	<b>Danger</b>	47
This Gate Must Be Kept Locked	<b>Notice</b>	86
This Is A Drug-Free Workplace	<b>Notice</b>	32
This Is A Drug-Free Workplace / Esta Es Un Area...	<b>Notice / Aviso</b>	56

Legend Text	Header	Pg
This Is A No Smoking Lunch Area	<b>Notice</b>	137
This Is A Safety Helmet Area	-	154
This Is A Smoke Free Facility Thank You For Not Smoking	-	141
This Is A Smoke Free Facility Thank You For Not...	-	58
This Is A Smoke Free Tobacco Free Facility Thank...	-	141
This Is A Smoke Free Work Place	-	141
This Is A Smoke Free Workplace	-	189
This Is A Smoke-Free Building	-	141
This Is A Smoke-Free Campus Smoking Prohibited	-	141
This Is Your Home Five Days Of The Week Help Keep...	-	142
This Is Your Lunch Area Keep It Clean	<b>Please</b>	133
This Is Your Wash Room Please Help Keep It Clean	-	135
This Is Your Wash Room Please Help Keep It Clean	-	142
This Is Your Washroom Help Keep It Clean	-	142
This Is Your Washroom Help Keep It Clean! / Este...	-	58
This Is Your Washroom Please Help Keep It Clean	-	142
This Job Has Worked [#] Days Without A Lost Time...	-	166
This Line Carries High Voltage Damage To This Line...	<b>Danger</b>	90
This Lunchroom Is Here For Your Convenience Please...	-	135
This Machine Is Automatically Controlled - It May...	<b>Caution / Precaucion</b>	50
This Machine Must Be Locked Out Prior To Servicing	<b>Caution</b>	118
This Machine Must Be Locked Out Prior To Servicing...	<b>Caution</b>	39
This Machine Starts And Stops Automatically Stay...	<b>Danger</b>	47
This Machine Starts And Stops Automatically	<b>Danger</b>	127
This Machine Starts And Stops Automatically / Esta...	<b>Danger / Peligro</b>	53
This Machine Starts Automatically	<b>Danger</b>	127
This Machine Starts Automatically	<b>Warning</b>	130
This Machine Starts By Remote Control	<b>Caution</b>	122
This Magnet Is Always On	<b>Danger</b>	156
This Motor Starts By Remote Control	<b>Caution</b>	122
This Plant Has Worked [#] Days Without A Disabling...	-	166
This Plant Has Worked [#] Days Without A Lost Time...	-	166
This Property Is Protected By Electronic Surveillance	<b>Security Notice</b>	168
This Property Protected By Electronic Surveillance	<b>Notice</b>	32
This Property Protected By Electronic Surveillance	<b>Restricted Area</b>	167
This Property Protected By Security Patrol	<b>Warning</b>	168
This Restroom Is Here For Your Convenience...	-	135
This Room Is Protected By Halon Fire Extinguisher...	<b>Caution</b>	100
This Sink Is For Food Wash Only	-	131
This Sink Is For Hand Wash Only	-	131
This Sink Is For Utensil Wash Only	-	131
This Space Must Be Kept Clear At All Times	<b>Caution</b>	132
This Space Must Be Kept Clear At All Times /...	<b>Caution / Precaucion</b>	50
This Vehicle Stops At All Railroad Crossings	<b>Notice</b>	177
This Water Is Safe To Drink	<b>Notice</b>	72
This Water Is Unsafe To Drink	<b>Notice</b>	48
This Way Out	-	95
This Way Out Picto	-	95
This Way To Office	-	95
Thou Shalt Not Park Here	-	186
Thru Truck Route	-	186
To Open Break Glass And Pull Chain	-	106
To Sprinkler Control Valve Picto	-	106
To Stairway Picto	-	95
To Use Fire Extinguisher	-	115
Today	<b>Be Careful</b>	165
Today's Threat Advisory Guarded	-	169
Toluene	-	78
Tornado Shelter	<b>Notice</b>	100
Tornado Shelter	-	87
Tornado Shelter	-	95
Tornado Shelter	-	115
Tornado Shelter	-	169
Tornado Shelter / Refugio Contra Tornados	-	60
Tow-Away Special Placard Or License Plate Required	-	173
Tow-Away Zone	-	186
Toxic 6	-	80
Toxic Chemicals	<b>Danger</b>	71
Toxic Gas 2	-	80
Toxic Gas Do Not Enter When Light Is Flashing	<b>Danger</b>	71
Toxic Materials	<b>Danger</b>	71
Toxic/Hazardous Chemicals Are Used In This Workplace...	<b>Caution</b>	65
Trash Goes Here Don't Litter	-	158
Trash Only	-	158
Trash Only / Basura Solamente	-	58
Trespassers Will Be Prosecuted	<b>Notice</b>	32
Trichloroethylene	-	78
Tripping Hazard	<b>Caution</b>	122
Tripping Hazard Falls May Result In Injury	<b>Caution</b>	39
Truck Drivers Must Chock Wheels And Set Brakes...	-	186
Truck Drivers Must Remain With Their Vehicle	<b>Notice</b>	177
Truck Drivers Ring Bell And Wait	<b>Notice</b>	177
Truck Drivers Shut Off Motor Set Brakes Set Wheel Chocks	<b>Notice</b>	177
Truck Drivers Waiting For Loading Or Unloading Are...	-	186



# Sign Legend Index

BradyID.com/s34

Legend Text	Header	Pg
Truck Entrance	-	186
Truck Must Be Turned Off When Loading	Warning	178
Truck Parking	-	186
Truck Route	-	186
Trucks	-	187
Trucks Entering Highway	-	187
Try To See It Our Way Wear Goggles And Safety Glasses	-	162
Turn Machine Off When Not In Use	Caution	123
Turn Off Battery Charger Before Disconnecting Battery ...	Danger	90
Turn Off Cellular Phones, Pagers And Other Wireless ...	Notice	156
Turn Off Lights Conserve Energy	-	158
Turn Off Power Before Working On Machines	Danger	128
Turpentine	-	78
Two Way Feed	Danger	47
Two Way Feed	Danger	128
Two Way Traffic Ahead	-	187

## U

Ultrasound	-	117
Ultraviolet Light	Caution	155
Unauthorized Motor Vehicles Prohibited On This Property	-	169
Unauthorized Parking Mandates \$100 Fee	-	173
Unauthorized Personnel Are Not Permitted Inside Plant	Notice	32
Unauthorized Personnel Keep Out	Caution	29
Unauthorized Personnel Keep Out	Danger	31
Unauthorized Personnel Keep Out	Danger	47
Unauthorized Personnel Keep Out	Warning	33
Unauthorized Personnel Keep Out	Danger	31
Unauthorized Persons Keep Out	Restricted Area	33
Unauthorized Persons Keep Out	-	49
Unauthorized Persons Keep Out / Prohibido El...	Restricted Area / Area Restringida	58
Unauthorized Vehicles Prohibited	Security Notice	168
Underground Cable	Danger	90
Underground Cable Call Before Digging	Warning	90
Underground Live Wire	Danger	90
Unlawful To Operate This Equipment Within 10 Ft...	Caution	88
Unleaded Gasoline	-	78
Unloading Caustic	Danger	71
Unsafe Roof Keep Off	Danger	31
Unsafe To Drink Picto	-	77
Ups Pick Up	-	187
Usar Casco Protector En Esta Area	Peligro	55
Usar El Pasamanos	Precaucion	51
Use Crosswalk	-	187
Use Fuse Puller To Change Fuses	Caution	123
Use Guards	-	154
Use Hand Rail	-	131
Use Handrail	Caution	123
Use Handrail	Caution	147
Use Handrail / Usar El Pasamanos	Caution / Precaucion	51
Use Handrail Falls May Result In Injury	Caution	39
Use Lockout Device During Maintenance Or Any ...	Caution	118
Use Of Cellular Phone Is Prohibited In This Facility	Security Notice	135
Use Of Cellular Phones Not Allowed	-	135
Use Of Cellular Phones Prohibited	-	189
Use Of Safety Belt And Line Required For Any Work...	Notice	151
Use Other Door	Caution	29
Use Static Grounding Devices	Caution	88
Use Static Grounding Devices	Warning	90
Used Batteries	Caution	65
Used Oil	-	77
Used Oil Storage Area	-	77
Uso Obligatorio De Casco De Proteccion	Precaucion	51
Uso Obligatorio De Guantes Y Proteccion Para La...	Precaucion	51
Uso Obligatorio De Lentes De Seguridad A Partir De...	Aviso	57
Uso Obligatorio De Proteccion Auditiva	Precaucion	51
Uso Obligatorio De Proteccion Para La Vista	Precaucion	51
Utility Work Ahead	-	171

## V

Vacate Stall When Charging Completed	-	174
Valve Caps Must Be In Place On Cylinders When Not In...	-	77
Van Accessible	-	173
Vapor Respirator Required In This Area	Caution	147
Vehicle Must Be Plugged In	-	174
Vehicles Improperly Parked Subject To Removal At ...	-	187
Vehicles Must Come To A Complete Stop Before...	-	35
Vendors And Visitors Must Register At Main Office	Notice	167
Vendors And Visitors Must Register At Main Office...	Notice / Aviso	56
Very Hot Water	Caution	65

Legend Text	Header	Pg
Very Hot Water. Burns Or Injury May Occur.	Caution	39
Video Surveillance In Use On These Premises	Security Notice	168
Vinyl Acetate	-	78
Vinyl Chloride	-	78
Vinyl Chloride May Cause Cancer Authorized Personnel...	Danger	71
Violators Towed Away At Vehicle Owner's Expense ...	-	187
Violators Will Be Fined Min \$150 Handicapped...	-	173
Violators Will Be Towed At Owner's Expense	Warning	178
Visitor Parking	-	187
Visitors Must Report To Office / Los Visitantes...	Notice / Aviso	56
Visitors Must Wear Eye Protection Beyond This Point	Notice	151
Visitors Must Wear Hard Hats And Safety Glasses	Caution	147
Visitors Obtain Plant Pass In Main Office Before...	-	35
Visitors Only	Parking	177
Visitors Parking Only	-	187
Visitors Please Report To Office	-	169
Voltage Source	-	119

## W

Waiting Area	-	117
Walk Don't Run	Safety First	129
Walk Down Stairs Backwards	Caution	123
Walking Of Dogs Prohibited On This Property	-	35
Warning Fire Equipment Protected From Theft By...	-	106
Warning Forklift Traffic	-	111
Warning Forklift Traffic W/Picto	-	110
Warning If You Come In Contact With Corrosive...	-	77
Warning Radio-Frequency Radiation Hazard Check...	-	157
Warning Smoking Is Hazardous To Your Health	-	141
Warning Surveillance Zone You Are Being Watched	-	169
Warning This Area Contains A Chemical Known To...	-	77
Warning This Area Contains A Chemical Known To...	-	77
Warning This Equipment Starts Automatically	-	131
Warning This Machine Is Automatically Controlled...	Danger	47
Warning This Machine Is Automatically Controlled...	-	131
Warning This Machine Is Automatically Controlled...	Danger	128
Warning This Property Protected By Security Patrol	-	169
Warning Unlawful To Operate This Equipment Within...	-	131
Warning! Attack Dogs On Premises No Trespassing	-	35
Wash And Sanitize Hands Before Starting And...	-	142
Wash Hands And Arms Up To The Elbows For...	-	142
Wash Hands Before Leaving This Room	-	142
Wash Hands Before Leaving This Room / Lavarse...	-	59
Wash Hands Before Returning To Work	Notice	142
Wash Hands Before Returning To Work	-	115
Wash Hands Before Returning To Work / Lavarse...	Notice / Aviso	56
Wash Your Hands Before Eating Drinking Or Smoking	Avoid Contamination	142
Wash Your Hands Before Leaving As A Sanitary...	Notice	142
Wash Your Hands Before Leaving This Room	Notice	142
Wash Your Hands Before Leaving This Room / Lavarse...	Notice / Aviso	56
Waste Oil	-	77
Waste Oil Storage Area	-	77
Waste Oil Storage Area	-	78
Waste Solvent	-	77
Watch For Children	-	187
Watch For Falling Debris	Danger	128
Watch For Falling Debris Will Result In Serious...	Danger	47
Watch For Lift Trucks	Caution	123
Watch For Lift Trucks / Cuidado Con Los Montacargas	Caution / Precaucion	50
Watch For Lift Trucks Accident May Cause Injury.	Caution	39
Watch For Low Pipes	Caution	123
Watch For Moving Vehicles	-	189
Watch For Pedestrians	-	187
Watch For Trucks	-	187
Watch Out For Falling Ice	Caution	132
Watch Out For Fork Lift	-	111
Watch Out For Fork Lift Trucks	Caution	123
Watch Out For Fork Lift Trucks Accident May Cause Injury.	Caution	39
Watch Out For Fork Truck Operating In Area	Caution	123
Watch Out For Fork Truck Operating In Area Accident...	Caution	39
Watch Out For Forklift Trucks	-	110
Watch Out For Moving Equipment	Danger	128
Watch Out For Moving Equipment Stay Clear	Danger	47
Watch Out For The Other Person	Think	166
Watch Out For Trucks	Caution	176
Watch Out For Trucks. Accident May Cause Injury.	Caution	39
Watch Overhead Clearance	Caution	123
Watch Your Back When Lifting! Use Your Legs Not Your...	-	162
Watch Your Fingers And Your Hands	Caution	123
Watch Your Hands And Fingers / Cuidado Con Sus ...	Danger / Peligro	53
Watch Your Head	Caution	123
Watch Your Head	Danger	128

Legend Text	Header	Pg
Watch Your Head Low Clearance Could Result In Injury	Caution	39
Watch Your Step	-	95
Watch Your Step	-	111
Watch Your Step	-	131
Watch Your Step	Caution	123
Watch Your Step	Caution	147
Watch Your Step	Danger	128
Watch Your Step	Notice	129
Watch Your Step	Safety First	129
Watch Your Step	Warning	130
Watch Your Step	-	110
Watch Your Step	Caution	39
Watch Your Step	Caution	123
Watch Your Step / Camine Con Cuidado	Caution / Precaucion	50
Watch Your Step / Camine Con Cuidado	Caution / Precaucion	50
Watch Your Step Falls Can Result In Injury	Caution	39
Watch Your Step Use Handrail	Caution	123
Watch Your Step/Fall	-	131
Water Line	Danger	85
Water Shut Off	Notice	100
We Aim For Zero Injuries	-	162
We Are Doing Asbestos We Can	Notice	112
We Are Setting The Standard	-	162
We Cannot Be Responsible For Damage To Cars Or...	Notice	177
Wear Approved Breathing Apparatus Beyond This Point	Caution	147
Wear Breathing Apparatus In This Area	Caution	147
Wear Ear Protection	Caution	147
Wear Ear Protection	Caution	147
Wear Eye Protection	-	154
Wear Eye Protection	Caution	147
Wear Eye Protection	Caution	147
Wear Eye Protection When Using Power Tools	Safety First	152
Wear Eye Protection When Using This Machine	-	154
Wear Face Shield	Caution	147
Wear Face Shield	-	154
Wear Face Shield And Rubber Gloves When Handling ...	Danger	71
Wear Face Shield And Rubber Gloves When Handling...	Danger	47
Wear Face Shield Batteries May Explode Turn Off...	Caution	66
Wear Face Shield When Using Grinder	Safety First	152
Wear Face Shields, Rubber Gloves And Aprons When...	Safety First	72
Wear Foot Protection	Notice	151
Wear Gloves	-	154
Wear Gloves And Goggles	Caution	147
Wear Goggles	Safety First	152
Wear Goggles	Safety First	48
Wear Goggles And Rubber Gloves When Handling Chemicals	Danger	71
Wear Goggles And Rubber Gloves When Handling Chemicals	Warning	73
Wear Goggles Face Shield Rubber Gloves And Apron...	Caution	39
Wear Goggles Face Shield Rubber Gloves And Apron...	Caution	66
Wear Goggles Or Face Shield	Safety First	152
Wear Goggles Or Face Shield While Operating This...	Caution / Precaucion	51
Wear Goggles Or Face Shield While Operating This...	Caution	147
Wear Goggles Or Use Shield	-	154
Wear Goggles When Chipping Or Grinding	Danger	149
Wear Goggles When Handling Acid Or Caustic	Danger	71
Wear Goggles When Using This Machine	-	154
Wear Goggles When Using This Machine	Caution	147
Wear Goggles When Using This Machine	Caution	123
Wear Hard Hats	Notice	151
Wear Mask	-	154
Wear Proper Safety Equipment	Think	152
Wear Protective Clothing	Caution	147
Wear Protective Equipment	Caution	147
Wear Protective Equipment In This Area	Warning	152
Wear Protective Safety Equipment When Handling Caustic	Danger	71
Wear Respirator	-	154
Wear Respirator In This Area	Warning	49
Wear Respirator To Protect Your Lungs	Caution	40
Wear Respirator While Spraying	Caution	147
Wear Respirator While Spraying	Danger	149
Wear Safety Equipment	Caution	147
Wear Safety Shoes In This Area	Caution	147
Wear Splash Goggles Face Shield Rubber Gloves...	Notice	151
Wear Your Fall Protection	Caution	147
Wear Your Gloves	Warning	152
Wear Your Goggles	-	154
Wear Your Goggles While Operating This Machine	Danger	149
Wear Your Hair Net	-	142
Wear Your Respirator	Caution	147
Wear Your Respirator	Caution	39
Wear Your Safety Glasses Foresight Is Better Than ...	-	154
Welding Arc Wear Proper Eye Protection	Danger	71

Legend Text	Header	Pg
Welding Arc. Wear Proper Eye Protection	Danger	47
Welding Area	Caution	66
Welding Area	Danger	71
Welding Fumes May Be Present	Caution	66
Welding Fumes May Be Present	Caution	39
Welding Goggles Must Be Worn At All Times	Danger	149
Welding May Produce Fumes And Gases Hazardous...	Caution	66
Wet Floor	Caution	123
Wet Floor Falls May Result In Injury	Caution	39
Wet Floors Be Careful	Caution	132
Wheel Chocks Must Be Placed On Both Sides Before...	Safety First	129
Wheelchair Ramp	-	173
Wheels Must Be Chocked And Engine Turned Off During ...	Notice	177
Wheels Must Be Chocked Before Loading Or Unloading	Safety First	177
Wheels Must Be Chocked Before Loading Or Unloading...	Notice / Aviso	57
When Servicing Or Checking Batteries Face And Hand...	Caution	88
When Throwing Switch Use Left Hand And Turn Face Away	Caution	118
Wide Right Turns	Caution	176
Wide Right Turns	Caution	39
Wide Right Turns	Caution	176
Will Call	-	187
Woman Picto	-	159
Women	-	115
Women	-	159
Women (Braille)	-	63
Women / Mujeres	-	59
Women / Mujeres	-	59
Women's Health	-	117
Wood Dust Explosion Hazard	Warning	73
Work Area Ahead	-	171
Work Safely Today	-	162
Work Safely You Count	-	162
Worker In Confined Space	-	84
Worker In Confined Space	Caution	82
Would You Like Some Cheese To Along With That Whine?	-	112
Wrong Way	-	187

## X

X-Ray In Use	Caution	155
X-Ray Producing Machine Within	-	157
X-Ray Radiation	Warning	156
Xylene	-	78

## Y

Yield	-	187
Yield Pedestrian Crossing	-	187
Yield Pedestrian Crosswalk	-	187
Yield Proceed Slowly	-	187
You Are The Key To Safety	-	162
You Can Obtain A Pair Of Safety Goggles Ask Your ...	Notice	151
You Must Be At Least 18 Years Old To Operate Equipment	Warning	130
Your Habits Are A Reflection Of You...Clean Up And...	-	135
Your Job Is Not Complete Until Your Area Is Clean	-	135



# Part Number Index

BradyID.com/s34

Catalog #	Pg	Catalog #	Pg	Catalog #	Pg	Catalog #	Pg	Catalog #	Pg	Catalog #	Pg	Catalog #	Pg	Catalog #	Pg	Catalog #	Pg		
64MB-CF	381	4001	256	4064	257	4153	257	5603-II	401	5774	258	7062	250	7150	251	7231	251		
1500	215	4002	256	4065	257	4154	257	5613	258	5775	258	7063	250	7151	251	7232	251	7233	251
1500-# KIT	215	4003	256	4066	257	4155	257	5617	258	5776	258	7064	250	7152	251	7233	251		
1500-LTR KIT	215	4004	256	4067	257	4156	257	5622	258	5777	258	7065	250	7153	251	7234	251		
1520	215	4005	256	4068	257	4157	256	5624	258	5778	258	7066	250	7154	251	7235	251		
1520-# KIT	215	4006	256	4070	257	4158	256	5631	258	5779	258	7067	250	7155	251	7236	251		
1530	215	4007	256	4071	257	4160	256	5632	258	5782	258	7068	250	7156	251	7237	251		
1530-# KIT	214	4008	256	4072	257	4162	256	5634	258	5783	258	7069	250	7157	251	7238	251		
1530-LTR KIT	214	4009	256	4073	257	4165	256	5636	258	5784	258	7070	250	7158	251	7239	251		
1530-LTR KIT	215	4010	256	4074	257	4167	256	5637	258	5787	258	7071	250	7159	251	7240	251		
1534	215	4010-A	401	4075	257	4169	256	5643	258	5790	258	7072	250	7160	251	7241	251		
1534-# KIT	215	4010-B	401	4076	257	4170	256	5645	258	5791	258	7073	250	7161	251	7242	251		
1534-LTR KIT	215	4010-C	401	4077	257	4172	256	5647	258	5793	258	7074	250	7162	251	7243	251		
1550	215	4010-D	401	4078	257	4173	256	5648	258	5890	258	7075	250	7163	251	7244	251		
1550-# KIT	215	4010-F	401	4079	257	4174	257	5653	258	5900	216	7076	250	7164	251	7245	251		
1550-LTR KIT	215	4010-H	401	4080	257	4175	257	5654	258	5905	216	7077	250	7165	251	7246	251		
1560	215	4011	256	4081	257	4176	257	5655	258	5910	216	7078	250	7166	251	7247	251		
1560-# KIT	215	4011-A	401	4082	257	4177	257	5658	258	5920	216	7079	250	7167	251	7248	251		
1560-# KIT	215	4011-B	401	4083	257	4178	257	5660	258	6001	217	7080	250	7168	251	7249	251		
1560-LTR KIT	215	4011-C	401	4084	257	4179	257	5662	258	6002	217	7081	250	7169	251	7250	251		
1570	215	4011-D	401	4085	257	4180	257	5663	258	6003	217	7082	250	7170	251	7251	251		
1570-# KIT	215	4011-F	401	4086	257	4181	257	5664	258	6004	217	7083	250	7171	251	7252	251		
1570-# KIT	215	4011-H	401	4087	257	4184	257	5665	258	6450	217	7084	250	7172	251	7253	251		
1570-LTR KIT	215	4012	256	4088	257	4185	257	5668	258	6500	217	7085	250	7173	251	7254	251		
1600	217	4012-A	401	4089	257	4186	257	5671	258	6560	216	7086	250	7174	251	7255	251		
2001	212	4012-B	401	4090	257	4187	257	5672	258	6570	216	7087	250	7175	251	7256	251		
2002	212	4012-C	401	4091	257	4189	257	5673	258	7000	250	7088	250	7176	251	7257	251		
2005	211	4012-D	401	4092	257	4190	257	5675	258	7001	250	7089	250	7177	251	7258	251		
2007	211	4012-F	401	4093	257	4193	257	5676	258	7002	250	7090	250	7178	251	7259	251		
2010	211	4012-H	401	4094	257	4194	257	5677	258	7003	250	7091	250	7179	251	7260	251		
2010DB	211	4013	256	4095	257	4195	257	5678	258	7004	250	7092	250	7180	251	7261	251		
2010DBSP	211	4013-A	401	4096	257	4197	257	5685	258	7005	250	7093	250	7181	251	7262	251		
2010NB	211	4013-B	401	4097	257	4198	257	5686	258	7006	250	7094	250	7182	251	7263	251		
2010SP	211	4013-C	401	4098	257	4199	257	5688	258	7007	250	7095	250	7183-3C	255	7264	251		
2011	284	4013-D	401	4099	257	4222	257	5689	258	7008	250	7096	250	7183-4	255	7265	251		
2011L	284	4013-F	401	4100	257	4225	257	5691	258	7009	250	7097	250	7184	251	7266	251		
2012	212	4013-H	401	4101	257	4226	257	5692	258	7010	250	7098	250	7184-3C	255	7267	251		
2014	212	4014	256	4102	257	4227	257	5693	258	7011	250	7099	250	7184-4	255	7268	251		
2014W	212	4015	256	4103	257	4228	257	5694	258	7012	250	7100	250	7185-3C	255	7269	251		
2019	285	4016	256	4104	257	4229	257	5695	258	7013	250	7101	250	7185-4	255	7270	251		
2019L	285	4017	256	4105	257	4240	257	5696	258	7014	250	7102	250	7186	251	7271	251		
2022	211	4018	256	4106	257	4241	257	5697	258	7015	250	7103	250	7186-3C	255	7272	251		
2023	211	4019	256	4107	257	4243	257	5698	258	7016	250	7104	250	7186-4	255	7273	251		
2024	211	4020	256	4108	257	4244	257	5699	258	7017	250	7105	250	7187	251	7274	251		
2025	211	4021	256	4109	257	4245	257	5700	258	7018	250	7106	250	7188	251	7275	251		
2026	211	4022	256	4110	257	4247	257	5701	258	7019	250	7107	250	7189	251	7276	251		
2027	211	4023	256	4111	257	4248	257	5702	258	7020	250	7108	250	7190	251	7277	251		
2028	211	4024	256	4112	257	4249	257	5703	258	7021	250	7109	250	7191	251	7278	251		
2032	211	4025	256	4113	257	4260	257	5706	258	7022	250	7110	250	7192	251	7279	251		
2112	488	4026	256	4114	257	4261	257	5707	258	7023	250	7111	250	7193	251	7280	251		
2112-TEN	488	4027	256	4115	257	4264	257	5708	258	7024	250	7112	250	7194	251	7281	251		
2112SP	488	4028	256	4116	257	4266	257	5709	258	7025	250	7113	250	7195	251	7282	251		
2112SP-TEN	488	4029	256	4117	257	4267	257	5710	258	7026	250	7114	250	7196	251	7283	251		
3000-	217	4030	256	4118	257	4269	257	5712	258	7027	250	7115	250	7197	251	7284	251		
3001	455	4031	256	4119	257	4270	257	5715	258	7028	250	7116	250	7198	251	7285	251		
3002	455	4032	256	4120	257	4271	257	5716	258	7029	250	7117	250	7200	251	7286	251		
3003Y	457	4033	256	4121	257	4272	257	5718	258	7030	250	7118	250	7202	251	7287	251		
3004Y	457	4034	256	4122	257	4273	257	5719	258	7031	250	7119	250	7203	251	7288	251		
3010	217	4035	256	4123	257	4274	257	5720	258	7032	250	7120	250	7204	251	7289	251		
3012	455	4036	256	4124	257	4275	257	5721	258	7033	250	7121	250	7205	251	7290	251		
3013	455	4037	256	4125	257	4277	257	5722	258	7034	250	7122	250	7206	251	7291	251		
3020	217	4038	256	4127	257	4279	257	5723	258	7035	250	7123	250	7207	251	7292	251		
3400-# KIT	214	4039	256	4128	257	4281	257	5724	258	7036	250	7124	250	7208	251	7293	251		
3400-LTR KIT	214	4040	256	4129	257	4283	257	5727	258	7038	250	7125	250	7209	251	7294	251		
3400-	214	4041	256	4130	257	5000	216	5728	258	7039	250	7126	250	7210	251	7295	251		
3410	214	4042	256	4131	257	5010	217	5729	258	7040	250	7127	250	7210-3C	255	7296	251		
3410-# KIT	214	4043	256	4132	257	5040	217	5730	258	7041	250	7128	250	7210-4	255	7297	251		
3410-LTR KIT	214																		



Catalog #	Pg	Catalog #	Pg	Catalog #	Pg	Catalog #	Pg	Catalog #	Pg	Catalog #	Pg	Catalog #	Pg	Catalog #	Pg	Catalog #	Pg
8220-	217	13537.	396	13628.	402	15563.	253	20027.	84	20488.	254	22103.	30	22209.	33	22329.	70
8235-	217	13538.	392	13629.	400	15566.	253	20028.	84	20489.	254	22104.	30	22210.	33	22330.	70
8240-	217	13539.	392	13629.	402	15567.	253	20400.	254	20490.	254	22105.	30	22211.	61	22331.	70
8245-	217	13540.	392	13630.	400	15569.	253	20401.	254	20585.	403	22106.	30	22212.	61	22332.	70
8250-	217	13541.	392	13630.	402	15570.	253	20402.	254	20589.	403	22109.	30	22213.	33	22333.	71
8255-	217	13542.	392	13631.	400	15571.	253	20403.	254	20591.	381	22110.	30	22214.	33	22334.	71
8782-	250	13543.	392	13631.	402	15572.	253	20404.	254	20596.	381	22111.	30	22216.	33	22335.	71
8783-	250	13544.	392	13632.	400	15573.	253	20405.	254	20602.	403	22112.	30	22217.	33	22336.	71
8784-	250	13545.	392	13632.	402	15574.	253	20406.	254	21335.	127	22113.	30	22218.	33	22337.	71
8785-	250	13546.	392	13633.	400	15576.	253	20407.	254	21338.	127	22114.	30	22219.	33	22338.	71
8786-	250	13547.	392	13633.	402	15578.	253	20408.	254	21700.	48	22115.	30	22220.	34	22339.	71
8787-	250	13548.	392	13634.	400	15580.	253	20409.	254	21703.	48	22116.	30	22221.	34	22341.	71
8788-	250	13549.	392	13634.	402	15581.	253	20410.	254	21707.	48	22117.	31	22222.	34	22342.	71
8789-	251	13550.	392	13635.	400	15582.	253	20411.	254	21709.	38	22118.	31	22224.	34	22343.	71
8790-	251	13551.	392	13635.	402	15583.	253	20412.	254	21713.	37	22121.	31	22225.	34	22349.	71
8791-	251	13552.	392	13636.	400	15584.	253	20413.	254	21718.	49	22122.	31	22226.	34	22350.	71
8792-	251	13553.	392	13636.	402	15585.	253	20414.	254	21723.	41	22123.	31	22227.	34	22351.	71
8793-	251	13554.	392	13637.	400	15586.	253	20415.	254	21725.	44	22124.	31	22228.	34	22353.	71
8795-	251	13555.	392	13637.	402	15587.	253	20416.	254	21726.	47	22125.	31	22229.	34	22354.	71
8796-	251	13556.	392	13638.	402	15588.	253	20417.	254	21727.	42	22126.	31	22232.	34	22355.	72
8797-	251	13557.	392	13639.	402	15589.	253	20418.	254	21728.	43	22127.	31	22233.	34	22356.	72
8799-	251	13558.	392	13640.	402	15590.	253	20419.	254	21729.	43	22128.	31	22234.	34	22357.	72
8801-	251	13559.	392	13651.	392	15591.	253	20421.	254	21778.	43	22129.	31	22236.	34	22358.	72
8802-	251	13560.	392	13652.	392	15592.	253	20422.	254	21780.	45	22130.	31	22237.	34	22359.	72
8803-	251	13561.	392	13653.	392	15593.	253	20424.	254	21782.	43	22131.	31	22241.	34	22360.	72
8804-	251	13562.	392	13654.	392	15594.	253	20425.	254	21783.	46	22132.	31	22246.	35	22361.	72
8807-	251	13563.	392	13655.	392	15595.	253	20426.	254	21784.	42	22133.	31	22247.	35	22362.	72
8808-	251	13564.	395	13656.	392	15596.	253	20427.	254	21785.	42	22134.	31	22248.	35	22363.	72
8809-	251	13565.	395	13704.	396	15597.	253	20428.	254	21788.	38	22135.	31	22249.	35	22364.	72
8920-	251	13566.	395	13705.	396	15598.	253	20429.	254	21795.	37	22136.	31	22251.	35	22365.	72
8921-	251	13567.	395	13706.	396	15599.	253	20430.	254	21797.	37	22137.	31	22253.	184	22366.	72
8922-	251	13568.	395	13707.	396	15600.	253	20431.	254	21798.	48	22138.	31	22254.	35	22367.	72
8923-	251	13569.	395	14216.	56	16840.	71	20432.	254	21800.	61	22141.	31	22255.	35	22368.	72
9703-	216	13570.	395	14218.	56	16841.	71	20433.	254	21801.	37	22142.	31	22256.	35	22369.	72
9704-	216	13571.	395	14219.	56	16953.	90	20434.	254	21803.	39	22143.	31	22257.	35	22371.	73
9705-	216	13572.	395	15424.	260	16954.	90	20435.	254	21804.	39	22144.	31	22258.	35	22372.	73
9706-	216	13573.	395	15424.	401	17923.	234	20436.	254	21805.	48	22145.	31	22260.	35	22373.	73
9707-	216	13574.	395	15500.	253	17924.	234	20437.	254	21806.	48	22146.	31	22261.	35	22374.	73
9708-	216	13575.	395	15501.	253	17925.	234	20438.	254	21807.	48	22147.	31	22262.	64	22377.	73
9712-# KIT	215	13576.	395	15502.	253	17926.	234	20439.	254	21808.	48	22148.	31	22263.	64	22378.	73
9712-LTR KIT	215	13577.	395	15503.	253	17927.	234	20440.	254	21810.	48	22150.	31	22266.	64	22380.	74
9712-	215	13578.	395	15504.	253	17928.	234	20441.	254	21813.	49	22151.	32	22267.	64	22381.	74
9713-	215	13579.	395	15507.	253	17942.	74	20442.	254	21814.	49	22152.	32	22268.	64	22385.	76
9713-# KIT	215	13580.	395	15508.	253	17942.	74	20443.	254	21815.	46	22156.	32	22269.	64	22386.	77
9713-LTR KIT	215	13585.	395	15509.	253	17943.	74	20444.	254	21866.	41	22157.	32	22270.	64	22399.	144
9714-	215	13590.	395	15512.	253	17943.	74	20445.	254	21868.	44	22158.	32	22272.	64	22400.	144
9714-# KIT	215	13595.	396	15515.	253	17944.	74	20446.	254	22052.	176	22160.	32	22273.	64	22402.	144
9714-LTR KIT	215	13596.	396	15516.	253	17944.	74	20447.	254	22053.	28	22161.	32	22277.	65	22403.	145
9720-	216	13597.	396	15517.	253	17945.	74	20448.	254	22054.	28	22162.	32	22282.	65	22404.	145
9730-	216	13598.	396	15518.	253	17945.	74	20449.	254	22059.	28	22163.	32	22283.	65	22406.	145
9740-	216	13599.	396	15520.	253	17946.	76	20450.	254	22060.	28	22164.	32	22285.	65	22407.	145
9750-	216	13600.	396	15521.	253	17946.	76	20452.	254	22061.	28	22166.	32	22287.	65	22408.	145
9760-	216	13601.	392	15522.	253	17947.	76	20453.	254	22062.	28	22168.	32	22289.	65	22409.	82
9770-	216	13602.	392	15523.	253	17947.	76	20454.	254	22063.	28	22171.	32	22291.	65	22410.	82
13284	110	13603.	392	15524.	253	17948.	76	20455.	254	22064.	28	22172.	32	22292.	66	22411.	82
13377	171	13604.	392	15526.	253	17948.	76	20456.	254	22065.	28	22173.	32	22293.	66	22412.	82
13377	171	13605.	392	15527.	253	17949.	76	20457.	254	22066.	28	22174.	32	22295.	66	22415.	86
13402	395	13606.	392	15530.	253	17949.	76	20458.	254	22067.	28	22175.	32	22296.	66	22416.	146
13403	395	13607.	392	15532.	253	17950.	76	20459.	254	22069.	28	22176.	32	22297.	66	22417.	146
13404	395	13608.	392	15533.	253	17950.	76	20460.	254	22070.	28	22177.	32	22298.	66	22418.	146
13510	396	13609.	392	15534.	253	17951.	76	20461.	254	22071.	29	22178.	32	22299.	66	22419.	146
13511	396	13610.	392	15535.	253	17951.	76	20462.	254	22072.	29	22179.	32	22300.	66	22424.	70
13512	396	13611.	392	15536.	253	17952.	76	20463.	254	22074.	29	22180.	33	22301.	66	22425.	83
13513	396	13612.	392	15537.	253	17952.	76	20464.	254	22075.	29	22181.	33	22302.	66	22426.	83
13514	396	13613.	392	15538.	253	17953.	76	20465.	254	22076.	29	22183.	33	22304.	66	22429.	70
13515	396	13614.	392	15539.	253	17953.	76	20466.	254	22077.	29	22184.	33	22305.	67	22430.	70
13516	396	13615.	392	15540.	253	17954.	76	20467.	254	22078.	29	22185.	33	22306.	67	22432.	29
13517	396	13616.	392	15541.	253	17954.	76	20468.	254	22079.	29	22186.	33	22308.	67	22433.	29
13518	396	13617.	392	15542.	253	17955.	75	20469.	254	22080.	29	22187.	33	22309.	67	22434.	29
13519	396	13618.	392	15543.	253	17955.	75	20470.	254	22082.	29	22188.	33	22310.	67	22437.	84
13520	396	13620.	400	15544.	253	17956.	75	20471.	254	22083.	29	22190.	33	22311.	67	22438.	84
13521	396	13620.	402	15545.	253	17956.	75	20472.	254	22084.	29	22191.	33	22312.	67	22441.	84
13522	396	13621.	400	15546.	253	19193.	83	20473.	254	22086.	29	22192.	33	22313.	67	22443.	156
13523	396	13621.	402	15547.	253	19194.	83	20474.	254	22087.	29	22195.	33	22314.	67	22445.	156
13524	396	13622.	400	15548.	253												

# Part Number Index

BradyID.com/s34

Part Number Index

Catalog #	Pg	Catalog #	Pg	Catalog #	Pg	Catalog #	Pg	Catalog #	Pg	Catalog #	Pg	Catalog #	Pg	Catalog #	Pg	Catalog #	Pg
22466	94	22567	90	22672	109	22810	133	22939	123	23043	128	23309	244	23486	243	23573	243
22467	94	22569	90	22673	109	22811	133	22940	123	23045	128	23400	243	23487	243	23574	243
22468	94	22570	90	22678	109	22813	133	22941	123	23046	128	23401	243	23488	243	23575	243
22469	94	22575	143	22679	109	22816	133	22942	123	23047	128	23402	243	23489	243	23576	243
22470	94	22576	143	22680	109	22817	133	22943	118	23048	128	23403	243	23490	243	23577	243
22471	94	22577	143	22681	109	22818	133	22945	124	23049	149	23404	243	23491	243	23578	243
22472	94	22578	143	22684	109	22819	133	22946	124	23051	128	23405	243	23492	243	23579	243
22473	95	22579	143	22685	109	22820	133	22948	124	23052	128	23406	243	23493	243	23580	243
22475	95	22580	143	22686	109	22821	133	22949	124	23054	128	23407	243	23494	243	23581	243
22476	95	22581	143	22688	100	22822	133	22950	124	23055	128	23408	243	23495	243	23582	243
22479	92	22582	143	22689	100	22823	133	22951	124	23056	128	23409	243	23496	243	23583	243
22480	92	22583	143	22690	106	22824	133	22952	124	23057	128	23410	243	23497	243	23584	243
22481	92	22584	144	22691	106	22825	133	22953	124	23058	128	23411	243	23498	243	23585	243
22482	92	22585	144	22692	106	22827	133	22955	124	23059	128	23412	243	23499	243	23586	243
22483	92	22586	144	22693	106	22828	133	22956	124	23060	128	23413	243	23500	243	23587	243
22484	92	22587	144	22695	106	22829	133	22957	124	23061	129	23414	243	23501	243	23588	243
22485	92	22588	146	22697	64	22832	134	22958	124	23062	129	23415	243	23502	243	23589	243
22486	92	22589	146	22698	64	22833	134	22960	124	23063	129	23416	243	23503	243	23596	243
22487	93	22590	146	22699	64	22834	134	22961	124	23064	129	23417	243	23504	243	23597	243
22488	93	22591	146	22700	64	22835	134	22962	124	23065	129	23418	243	23505	243	23598	243
22489	93	22592	147	22701	64	22836	134	22963	124	23066	129	23419	243	23506	243	23599	243
22490	93	22593	147	22703	64	22839	134	22964	124	23069	129	23420	243	23507	243	23600	243
22491	93	22594	147	22704	64	22840	134	22965	125	23070	129	23421	243	23508	243	23601	243
22492	93	22595	147	22707	65	22841	134	22966	125	23071	129	23422	243	23509	243	23602	243
22493	93	22596	147	22708	65	22842	134	22968	125	23074	129	23423	243	23510	243	23603	243
22494	93	22597	147	22709	65	22843	134	22970	125	23077	129	23424	243	23511	243	23604	243
22495	102	22599	147	22710	65	22844	134	22971	125	23078	129	23425	243	23512	243	23605	243
22496	102	22600	147	22711	65	22845	134	22972	125	23079	129	23426	243	23513	243	23606	243
22497	102	22601	147	22712	65	22846	134	22973	125	23090	67	23427	243	23514	243	23607	243
22498	105	22602	147	22713	65	22847	134	22974	125	23092	32	23428	243	23515	243	23608	243
22499	94	22603	147	22714	65	22849	134	22975	125	23199	236	23429	243	23516	243	23609	243
22500	94	22605	148	22717	65	22850	134	22976	125	23200	243	23430	243	23517	243	23617	243
22501	94	22606	148	22718	65	22851	135	22977	125	23200	244	23431	243	23518	243	23618	243
22502	94	22607	148	22719	176	22852	135	22978	125	23201	243	23432	243	23519	243	23619	243
22503	95	22608	148	22720	176	22853	135	22981	125	23201	244	23433	243	23520	243	23620	243
22504	95	22609	148	22721	66	22854	135	22982	125	23202	243	23434	243	23521	243	23621	243
22505	86	22612	148	22722	66	22855	135	22983	125	23202	244	23435	243	23522	243	23622	243
22507	86	22613	148	22723	66	22856	135	22984	125	23203	243	23436	243	23523	243	23623	243
22508	86	22614	149	22725	66	22857	135	22985	125	23203	244	23437	243	23524	243	23624	243
22509	86	22615	149	22726	66	22858	135	22986	125	23204	243	23438	243	23525	243	23625	243
22510	86	22619	149	22727	67	22861	120	22987	125	23205	243	23439	243	23526	243	23626	243
22511	86	22620	149	22728	67	22862	120	22989	125	23206	243	23440	243	23527	243	23630	243
22512	86	22621	149	22729	68	22863	120	22993	125	23207	243	23441	243	23528	243	23631	243
22513	86	22622	150	22730	68	22864	120	22994	125	23208	243	23442	243	23529	243	23632	243
22514	86	22623	150	22741	69	22865	120	22995	125	23209	243	23443	243	23530	243	23633	243
22515	86	22624	150	22742	69	22867	120	22996	125	23210	244	23444	243	23531	243	23634	243
22516	86	22625	150	22745	69	22870	120	22998	125	23211	244	23445	243	23532	243	23635	243
22517	121	22626	151	22746	69	22873	120	23000	126	23212	244	23446	243	23533	243	23636	243
22518	121	22627	151	22749	69	22874	120	23001	126	23213	244	23447	243	23534	243	23637	243
22519	86	22628	151	22750	69	22875	120	23002	126	23215	100	23448	243	23535	243	23638	243
22520	86	22629	151	22751	69	22876	120	23003	126	23216	100	23449	243	23536	243	23639	243
22521	86	22630	151	22752	69	22877	120	23004	126	23256	243	23450	243	23537	243	23640	243
22522	86	22631	151	22753	69	22878	120	23005	126	23257	243	23451	243	23538	243	23641	243
22523	86	22632	107	22754	69	22879	120	23006	126	23258	243	23452	243	23539	243	23642	243
22524	86	22633	107	22760	70	22880	120	23007	126	23259	243	23453	243	23540	243	23643	243
22525	86	22635	107	22761	70	22883	120	23008	126	23260	243	23454	243	23541	243	23644	243
22526	86	22636	107	22764	71	22891	120	23009	126	23261	243	23455	243	23542	243	23645	243
22527	86	22637	107	22765	71	22892	120	23010	126	23262	243	23456	243	23543	243	23646	243
22528	86	22638	107	22768	72	22895	120	23011	126	23263	243	23457	243	23544	243	23647	243
22530	86	22639	107	22769	72	22896	120	23012	126	23264	243	23458	243	23545	243	23648	243
22532	86	22642	107	22770	72	22897	121	23013	126	23265	243	23459	243	23546	243	23649	243
22533	86	22643	107	22771	72	22898	121	23014	126	23266	243	23460	243	23547	243	23650	243
22534	86	22644	107	22772	132	22901	121	23015	126	23267	243	23461	243	23548	243	23651	243
22535	86	22645	107	22773	132	22902	121	23016	126	23268	243	23462	243	23549	243	23652	243
22537	31	22646	107	22776	132	22903	121	23019	126	23269	243	23463	243	23550	243	23653	243
22538	31	22647	107	22777	132	22907	121	23020	126	23270	243	23464	243	23551	243	23654	243
22541	32	22648	107	22780	132	22909	118	23021	126	23271	243	23465	243	23552	243	23655	243
22542	32	22649	107	22782	132	22910	118	23022	126	23272	243	23466	243	23553	243	23656	243
22543	86	22650	108	22785	132	22913	121	23023	127	23273	243	23467	243	23554	243	23657	243
22544	86	22651	108	22790	132	22914	121	23024	127	23274	243	23468	243	23555	243	23658	243
22545	86	22652	108	22793	132	22915	121	23025	127	23275	243	23469	243	23556	243	23660	243
22546	86	22653	108	22794	133	22916	121	23026	127	23276	243	23470	243	23557	243	23661	243
22549	87	22654	108	22795	133	22917	121	23027	127	23277	243	23471	243	23558	243	23662	243

# Part Number Index

BradyID.com/s34

Catalog #	Pg	Catalog #	Pg	Catalog #	Pg	Catalog #	Pg	Catalog #	Pg	Catalog #	Pg	Catalog #	Pg	Catalog #	Pg
23677	243	25127	139	25246	152	25350	166	25498	152	25627	151	25741	73	25889	179
23678	243	25130	139	25247	152	25351	166	25499	152	25630	129	25742	61	25890	181
23679	243	25131	140	25248	153	25356	62	25502	88	25631	129	25743	61	25891	144
23680	243	25132	137	25250	142	25357	62	25503	88	25632	129	25745	75	25892	144
23682	243	25133	137	25251	142	25360	62	25505	88	25633	129	25746	76	25893	145
23683	243	25134	140	25254	155	25361	62	25506	88	25634	130	25747	132	25894	145
23684	243	25135	140	25255	155	25362	62	25512	88	25635	130	25748	132	25895	147
23685	243	25136	140	25256	155	25364	62	25513	88	25636	130	25751	132	25896	148
23686	243	25137	140	25257	155	25365	62	25515	88	25637	130	25752	132	25897	89
25026	129	25138	72	25258	155	25366	62	25516	88	25638	130	25753	132	25898	68
25027	129	25139	140	25259	155	25368	62	25517	88	25639	130	25754	132	25899	153
25028	129	25140	140	25260	155	25369	62	25520	88	25640	100	25755	132	25900	89
25029	129	25144	140	25261	155	25370	62	25521	88	25641	100	25758	132	25901	31
25030	129	25145	140	25263	155	25371	62	25522	89	25642	100	25759	132	25902	32
25031	129	25147	141	25264	155	25372	62	25524	89	25643	100	25760	132	25903	108
25032	129	25148	141	25265	155	25373	62	25526	89	25644	100	25761	91	25906	123
25033	129	25149	142	25266	155	25374	62	25527	89	25645	100	25762	91	25907	123
25034	129	25150	142	25267	155	25375	62	25530	89	25646	100	25763	91	25908	147
25035	129	25151	142	25268	155	25376	62	25531	89	25647	100	25764	91	25909	147
25037	129	25152	142	25269	155	25377	62	25532	89	25650	68	25765	91	25910	70
25038	129	25153	142	25270	156	25406	62	25533	89	25651	68	25766	91	25911	126
25039	130	25154	142	25272	156	25407	62	25534	89	25652	68	25767	92	25912	136
25040	130	25155	142	25273	156	25413	62	25537	89	25653	68	25768	92	25913	127
25041	130	25156	142	25274	156	25416	145	25538	89	25654	68	25771	90	25914	104
25043	130	25157	74	25275	156	25417	145	25539	89	25655	68	25772	90	25917	159
25044	130	25161	152	25276	156	25418	64	25540	89	25656	68	25773	143	25918	159
25045	130	25162	90	25277	156	25419	64	25541	89	25657	68	25777	66	25919	159
25048	130	25165	75	25278	156	25420	67	25545	89	25659	30	25780	61	25920	84
25049	130	25166	153	25279	156	25422	69	25545	89	25661	68	25781	61	25921	84
25050	131	25167	108	25280	156	25423	69	25545	89	25662	68	25792	176	25922	119
25051	131	25168	131	25281	156	25424	67	25548	89	25663	68	25795	176	25927	158
25052	131	25169	103	25282	156	25425	67	25549	89	25665	68	25798	176	25928	158
25053	131	25170	104	25283	156	25428	68	25551	90	25666	69	25801	176	25929	158
25058	131	25173	172	25284	156	25429	68	25552	90	25667	69	25804	29	25930	158
25060	136	25175	153	25285	156	25430	68	25553	90	25668	69	25805	177	25933	158
25061	136	25176	90	25286	157	25431	68	25556	90	25669	69	25806	177	25934	158
25062	136	25177	131	25288	157	25436	69	25557	90	25670	69	25807	177	25936	158
25063	136	25178	159	25289	157	25437	69	25560	90	25671	69	25815	126	25943	158
25064	136	25179	34	25291	157	25438	69	25562	90	25672	136	25816	126	25944	158
25065	136	25182	138	25292	157	25439	69	25563	90	25673	136	25819	177	25945	158
25068	69	25183	131	25295	165	25441	69	25564	90	25674	69	25823	177	25946	158
25069	69	25186	154	25297	165	25442	69	25565	90	25675	69	25824	177	25947	158
25073	136	25188	154	25298	165	25443	69	25566	88	25676	100	25825	177	25950	158
25076	136	25190	77	25299	165	25447	69	25567	88	25677	100	25826	177	25960	62
25077	136	25191	159	25300	165	25448	70	25569	88	25678	100	25828	177	25961	62
25078	136	25192	143	25301	165	25449	70	25570	151	25679	100	25829	177	25962	62
25079	136	25193	143	25302	165	25450	70	25571	151	25680	100	25830	177	25963	62
25080	137	25194	143	25303	165	25451	70	25574	151	25681	100	25831	177	25964	62
25081	137	25195	143	25304	165	25453	70	25575	151	25682	133	25832	177	25966	398
25082	137	25196	144	25307	165	25454	144	25576	151	25688	165	25833	177	25967	398
25083	137	25197	144	25309	165	25456	144	25577	151	25689	165	25834	177	25968	398
25084	137	25198	144	25310	165	25457	144	25578	151	25690	100	25835	177	25969	398
25085	137	25199	144	25311	165	25459	144	25579	151	25691	100	25836	177	25971	62
25086	137	25200	144	25312	165	25460	144	25581	152	25692	100	25838	177	25972	62
25087	137	25201	144	25313	165	25461	144	25583	152	25693	100	25839	177	25973	62
25088	137	25204	146	25314	165	25462	144	25584	152	25696	101	25845	178	25975	63
25089	137	25205	146	25315	165	25463	144	25585	152	25700	101	25846	178	25977	33
25090	137	25206	147	25316	165	25464	145	25589	153	25701	101	25847	179	25978	33
25091	137	25207	147	25317	165	25465	145	25591	153	25702	101	25848	179	26521	48
25092	137	25208	147	25319	165	25466	145	25592	153	25703	101	25849	180	26524	48
25093	137	25209	147	25320	165	25467	145	25594	143	25704	101	25851	180	26528	48
25094	137	25214	149	25323	165	25468	145	25595	143	25705	101	25852	181	26530	48
25095	137	25215	149	25324	165	25469	145	25596	121	25706	101	25853	181	26534	37
25097	137	25216	148	25325	165	25470	146	25597	121	25707	101	25854	181	26539	49
25098	138	25217	148	25326	165	25471	146	25598	122	25708	102	25855	181	26543	41
25099	138	25218	149	25327	165	25472	146	25599	122	25709	102	25857	182	26545	44
25100	138	25219	149	25328	165	25473	146	25600	122	25710	102	25858	182	26546	47
25101	138	25220	149	25329	165	25474	146	25601	122	25711	102	25859	183	26547	42
25102	138	25221	149	25330	165	25475	146	25604	122	25712	102	25860	177	26548	43
25103	138	25222	71	25331	165	25476	147	25605	122	25713	103	25861	177	26549	43
25104	138	25223	71	25332	165	25477	147	25606	122	25714	103	25862	183	26553	43
25105	138	25224	150	25333	165	25478	148	25607	122	25715	104	25864	184	26555	45
25108	138	25225	150	25334	165	25479	148	25608	123	25716	104	25865	184	26557	43
25109	75	25226	150	25335	165	25480	148	25609	123	25717	104	25868	177	26558	46
25110	138	25227	150	25336	165	25482	148	25610	123	25718	104	25869	184	26559	42
25114	138	25228	150	25337	165	25484	150	25611	123	25719	103	25870	184	26560	42
25115	138	25229	150	25338	165	25485	150	25612	123	25720	103	25871	186	26563	38
25116	138	25230	150	25339	166	25486	150	25613	123	25721	103	25872	186	26570	37
25117	138	25231	150	25340	166	25487	150	25614	124	25722	103	25874	178	26572	37
25118	138	25232	151	25341	166	25488	150	25615	124	25723	105	25875	187	26573	48
25119	138	25233	151	25342	166	25489	150	25618	126	25729	104	25876	119	26575	61
25120	138	25234	151	25343	166	25490	150	25619	126	25730	105	25877	119	26576	37
25121	138	25235	151	25344	166	25491	150	25620	126	25734	72	25878	66	26578	39
25122	138	25241	151	25346	166	25493									

# Part Number Index

BradyID.com/s34

Catalog #	Pg	Catalog #	Pg	Catalog #	Pg	Catalog #	Pg	Catalog #	Pg	Catalog #	Pg	Catalog #	Pg	Catalog #	Pg	Catalog #	Pg
36312	259	38138	58	38711	52	39542	58	40655	30	40757	33	40868	66	41017	93	41128	90
36313	259	38150	55	38730	52	39553	55	40656	30	40758	33	40869	67	41018	93	41129	90
36314	259	38151	52	38734	52	39554	55	40657	30	40759	33	40870	67	41019	93	41130	90
36315	259	38152	52	38742	57	39555	52	40658	30	40760	33	40871	67	41020	93	41131	90
36316	259	38158	57	38756	58	39556	52	40661	30	40761	33	40873	67	41021	93	41133	90
36317	259	38160	57	38767	53	39567	58	40662	30	40762	33	40874	67	41022	93	41134	90
36318	259	38162	58	38775	58	39576	53	40663	30	40763	33	40876	67	41023	93	41136	90
36319	259	38163	58	38797	60	39579	52	40664	30	40764	33	40877	67	41024	93	41137	90
37603	55	38172	53	38799	59	39590	52	40665	30	40765	33	40878	67	41025	103	41141	143
37604	55	38175	52	38800	59	39601	52	40666	30	40766	33	40879	67	41026	103	41142	143
37606	52	38188	57	38803	57	39605	52	40667	30	40767	33	40880	67	41029	94	41143	143
37612	57	38200	52	38813	60	39606	52	40668	30	40768	33	40881	67	41030	94	41145	143
37616	58	38205	52	38816	59	39613	57	40669	30	40769	33	40882	67	41031	94	41146	143
37617	58	38227	52	38819	56	39639	57	40670	30	40770	33	40883	67	41032	94	41147	88
37631	52	38239	57	38831	60	39649	58	40671	30	40772	33	40884	67	41033	94	41148	144
37635	52	38253	58	38837	56	39658	53	40672	30	40773	33	40885	67	41034	94	41149	144
37636	52	38264	53	38846	50	39696	60	40673	30	40774	33	40886	67	41035	94	41150	144
37645	57	38272	58	38848	57	39698	59	40674	30	40775	61	40887	67	41036	94	41151	144
37657	58	38307	60	38850	58	39718	56	40675	30	40776	61	40888	67	41037	95	41152	146
37660	59	38309	59	38864	55	39731	56	40676	30	40778	33	40891	70	41038	95	41153	146
37661	58	38310	59	38865	53	39738	50	40677	30	40780	33	40892	70	41043	92	41154	146
37683	60	38313	57	38866	54	39740	57	40678	30	40781	33	40895	70	41044	92	41155	146
37686	59	38323	60	38867	55	39742	58	40679	30	40782	168	40896	70	41045	92	41156	147
37690	56	38329	56	38875	57	39756	55	40680	30	40785	34	40897	71	41046	92	41157	147
37703	58	38338	56	38877	58	39758	54	40681	31	40786	34	40898	71	41047	92	41158	147
37718	53	38345	50	38892	53	39769	58	40682	31	40788	34	40899	71	41048	92	41159	147
37719	54	38347	57	38893	54	39780	53	40685	31	40789	34	40900	71	41049	92	41160	147
37720	55	38349	58	38902	57	39789	58	40686	31	40790	34	40901	71	41050	92	41161	147
37725	53	38359	55	38904	58	39803	55	40687	31	40791	34	40902	71	41051	93	41162	147
37737	55	38360	53	38914	55	39804	53	40688	31	40792	34	40904	71	41052	93	41163	147
37740	59	38361	54	38920	53	39811	53	40689	31	40793	34	40905	71	41053	93	41164	147
37743	59	38362	55	38928	55	39817	55	40690	31	40795	34	40906	71	41054	93	41165	147
37748	56	38368	57	38931	59	39820	59	40691	31	40796	34	40908	71	41055	93	41166	147
37758	55	38370	58	38933	59	39821	59	40692	31	40797	34	40913	71	41058	93	41167	147
37790	53	38383	53	38937	56	39833	53	40694	31	40798	34	40914	71	41059	102	41170	148
37793	55	38384	54	38942	50	39850	50	40695	31	40799	34	40920	72	41060	102	41171	148
37800	56	38392	58	38955	59	39860	55	40696	31	40800	34	40922	72	41061	102	41172	148
37803	51	38403	53	38964	50	39876	55	40698	31	40801	34	40923	72	41062	105	41173	148
37809	55	38404	54	38973	55	39880	59	40699	31	40803	34	40924	72	41063	94	41176	148
37833	53	38411	53	38976	59	39881	59	40700	31	40805	34	40925	72	41064	94	41177	148
37843	56	38417	55	38979	56	39883	59	40702	31	40806	34	40926	72	41065	94	41178	149
37847	51	38420	59	38984	50	39894	55	40703	31	40807	34	40927	72	41066	94	41184	149
37848	51	38425	56	38990	55	39912	55	40704	31	40808	34	40928	72	41067	95	41186	150
37849	53	38430	50	38993	58	39951	54	40705	31	40809	34	40933	72	41068	95	41187	150
37851B	97	38440	55	38994	59	39954	55	40706	31	40810	35	40934	72	41069	86	41188	150
37860	276	38444	59	38995	59	39961	56	40707	31	40811	35	40935	73	41070	86	41190	151
37861	276	38457	53	38997	59	39964	51	40708	31	40812	35	40936	73	41071	86	41191	151
37864	276	38463	55	39008	55	39965	51	40709	31	40813	35	40937	73	41073	86	41192	151
37865	276	38474	50	39012	59	39967	52	40710	31	40815	35	40938	73	41074	86	41193	151
38040	112	38478	55	39026	55	39978	53	40711	31	40816	184	40942	73	41075	86	41194	151
38047	112	38481	58	39029	58	39981	55	40712	31	40817	184	40943	74	41076	86	41195	151
38052	112	38482	59	39054	57	39991	51	40713	31	40818	35	40949	76	41077	86	41197	107
38055	112	38483	59	39055	57	40616	176	40714	31	40819	35	40953	82	41078	86	41198	107
38056	112	38485	59	39071	54	40617	28	40715	32	40820	35	40954	82	41079	86	41200	107
38061	112	38514	55	39074	55	40618	28	40716	32	40821	35	40964	144	41080	86	41201	107
38062	112	38571	54	39081	56	40621	28	40717	32	40825	35	40965	144	41081	121	41202	107
38065	112	38574	55	39084	51	40622	28	40718	32	40826	64	40966	144	41082	121	41203	107
38067	112	38581	56	39085	51	40623	28	40720	32	40827	64	40967	145	41083	122	41206	107
38068	112	38585	51	39086	51	40624	28	40721	32	40829	64	40968	145	41084	86	41207	107
38069	112	38586	51	39087	52	40625	28	40722	32	40831	64	40970	145	41085	86	41208	107
38071	112	38587	52	39108	53	40626	28	40723	32	40832	64	40971	145	41086	86	41209	107
38072	112	38603	54	39111	55	40627	28	40724	32	40833	64	40972	145	41087	86	41210	107
38073	112	38604	55	39121	51	40628	28	40725	32	40834	64	40973	82	41088	86	41211	107
38075	112	38605	52	39123	51	40629	28	40726	32	40836	64	40974	82	41090	86	41213	108
38076	112	38606	52	39124	53	40630	28	40728	32	40837	64	40975	82	41093	86	41214	107
38077	112	38612	57	39135	53	40631	28	40729	32	40840	65	40980	146	41094	86	41215	108
38082	101	38614	57	39138	55	40632	28	40730	32	40841	65	40981	146	41095	86	41217	108
38083	112	38616	58	39145	56	40633	28	40732	32	40846	65	40982	146	41096	86	41218	108
38084	112	38617	58	39148	51	40635	29	40734	32	40847	65	40983	146	41097	86	41219	108
38085	112	38628	55	39149	51	40636	29	40736	32	40848	65	40988	70	41098	86	41220	108
38086	112	38629	55	39150	51	40637	29	40737	32	40849	65	40989	83	41099	86	41221	108
38087	112	38630	52	39151	53	40638	29	40739	32	40850	65	40990	83	41100	86	41223	108
38088	245	38637	57	39161	55	40639	29	40740	32	40851	65	40991	83	41101	31	41225	108
38090	245	38640	58	39171	51	40640	29	40741	32	40852	65	40992	83	41102	31	41226	108
38091	245	38641	58	39173	51	40641	29	40742	32	40853	65	40993	83	41106	32	41227	108
38097B	97	38653	55	39480	474	40642	29	40744	137	40856	66	40994	83	41107	86	41229	108
38098B	97	38654	55	39503	54	40643	29	40746	3								

# Part Number Index

Catalog #	Pg	Catalog #	Pg	Catalog #	Pg	Catalog #	Pg	Catalog #	Pg	Catalog #	Pg	Catalog #	Pg	Catalog #	Pg
41250.....	109	41475.....	253	41952.....	158	42353.....	134	42495.....	125	42611.....	129	42722.....	140	42841.....	155
41252.....	100	41476.....	253	41953.....	158	42354.....	134	42496.....	125	42612.....	129	42723.....	140	42842.....	155
41253.....	100	41477.....	253	41956.....	158	42356.....	134	42497.....	125	42613.....	129	42724.....	141	42843.....	155
41254.....	106	41478.....	253	41959.....	158	42357.....	134	42498.....	125	42614.....	129	42725.....	141	42845.....	155
41255.....	106	41479.....	253	41961.....	158	42360.....	134	42499.....	125	42615.....	129	42726.....	142	42846.....	155
41256.....	106	41480.....	253	41963.....	158	42362.....	134	42500.....	125	42616.....	130	42727.....	142	42849.....	156
41257.....	106	41481.....	253	41972.....	158	42363.....	134	42501.....	125	42617.....	130	42728.....	142	42850.....	156
41260.....	106	41482.....	253	41990.....	67	42365.....	134	42502.....	125	42618.....	130	42729.....	142	42853.....	156
41261.....	64	41483.....	253	41991.....	67	42367.....	134	42503.....	125	42619.....	130	42730.....	142	42854.....	156
41262.....	64	41510.....	253	42004.....	342	42368.....	134	42504.....	125	42620.....	130	42731.....	142	42855.....	156
41264.....	64	41511.....	253	42007.....	342	42369.....	134	42505.....	125	42621.....	130	42732.....	142	42856.....	156
41266.....	64	41512.....	253	42009.....	342	42372.....	134	42506.....	125	42622.....	130	42733.....	142	42857.....	156
41267.....	64	41513.....	253	42062.....	343	42373.....	134	42507.....	125	42626.....	130	42734.....	74	42858.....	156
41268.....	64	41514.....	253	42063.....	343	42375.....	135	42508.....	125	42627.....	131	42737.....	130	42859.....	156
41271.....	65	41515.....	253	42064.....	343	42378.....	135	42509.....	125	42628.....	131	42738.....	152	42860.....	156
41272.....	65	41516.....	253	42065.....	343	42380.....	135	42510.....	125	42630.....	131	42739.....	90	42861.....	156
41273.....	65	41517.....	253	42066.....	343	42381.....	135	42511.....	125	42632.....	131	42740.....	90	42862.....	156
41274.....	65	41518.....	253	42067.....	343	42385.....	120	42514.....	125	42634.....	131	42743.....	153	42863.....	157
41275.....	65	41519.....	253	42068.....	343	42386.....	120	42515.....	125	42635.....	131	42744.....	108	42865.....	157
41276.....	65	41520.....	253	42069.....	343	42387.....	120	42516.....	125	42636.....	131	42745.....	131	42867.....	157
41281.....	65	41521.....	253	42071.....	343	42388.....	120	42518.....	125	42637.....	136	42746.....	103	42868.....	157
41282.....	65	41522.....	253	42072.....	342	42389.....	120	42519.....	125	42638.....	136	42747.....	104	42869.....	157
41283.....	176	41523.....	253	42073.....	342	42391.....	120	42521.....	125	42639.....	136	42748.....	75	42874.....	165
41284.....	176	41524.....	253	42100.....	343	42396.....	120	42522.....	126	42640.....	136	42752.....	153	42876.....	165
41285.....	66	41525.....	253	42101.....	343	42397.....	120	42523.....	126	42641.....	136	42753.....	90	42879.....	165
41286.....	66	41527.....	253	42102.....	343	42398.....	120	42524.....	126	42642.....	136	42754.....	131	42881.....	165
41293.....	68	41530.....	253	42103.....	343	42400.....	120	42525.....	126	42645.....	69	42755.....	159	42887.....	165
41294.....	68	41532.....	253	42104.....	343	42401.....	120	42526.....	126	42646.....	69	42756.....	34	42888.....	165
41305.....	69	41535.....	253	42105.....	343	42402.....	120	42527.....	126	42649.....	136	42759.....	138	42889.....	165
41306.....	69	41536.....	253	42137.....	343	42404.....	120	42528.....	126	42650.....	136	42760.....	131	42891.....	165
41310.....	69	41537.....	253	42138.....	343	42414.....	120	42529.....	126	42653.....	136	42763.....	154	42893.....	165
41313.....	69	41538.....	253	42139.....	343	42415.....	120	42530.....	126	42654.....	136	42765.....	154	42895.....	165
41314.....	69	41539.....	253	42211.....	221	42416.....	120	42531.....	126	42655.....	136	42766.....	109	42896.....	165
41315.....	69	41545.....	253	42217.....	221	42418.....	120	42533.....	126	42656.....	136	42767.....	77	42897.....	165
41316.....	69	41549.....	253	42221.....	221	42419.....	120	42534.....	126	42657.....	137	42768.....	159	42900.....	165
41317.....	69	41551.....	253	42228.....	228	42420.....	121	42535.....	126	42658.....	137	42769.....	143	42901.....	165
41318.....	69	41554.....	253	42229.....	228	42421.....	121	42536.....	126	42659.....	137	42771.....	143	42902.....	165
41324.....	70	41555.....	253	42230.....	228	42424.....	121	42539.....	126	42660.....	137	42772.....	143	42903.....	165
41325.....	70	41557.....	253	42231.....	228	42425.....	121	42541.....	228	42661.....	137	42773.....	144	42904.....	165
41328.....	71	41558.....	253	42233.....	228	42427.....	121	42542.....	126	42662.....	137	42774.....	144	42905.....	165
41329.....	71	41559.....	253	42234.....	228	42430.....	121	42543.....	126	42663.....	137	42775.....	144	42906.....	165
41332.....	72	41560.....	253	42238.....	228	42431.....	121	42546.....	127	42664.....	137	42776.....	144	42907.....	165
41333.....	72	41562.....	253	42241.....	228	42432.....	118	42547.....	127	42665.....	137	42777.....	144	42909.....	165
41334.....	72	41563.....	253	42242.....	228	42433.....	118	42548.....	127	42666.....	137	42778.....	144	42910.....	165
41335.....	72	41564.....	253	42243.....	228	42436.....	121	42549.....	127	42667.....	137	42781.....	146	42911.....	165
41336.....	132	41565.....	253	42244.....	228	42437.....	121	42550.....	127	42669.....	137	42782.....	146	42912.....	165
41337.....	132	41567.....	253	42245.....	228	42438.....	121	42551.....	127	42670.....	137	42783.....	147	42913.....	165
41342.....	132	41568.....	253	42247.....	228	42439.....	121	42554.....	127	42671.....	137	42784.....	147	42914.....	165
41348.....	132	41570.....	253	42248.....	228	42440.....	121	42555.....	127	42672.....	137	42785.....	147	42915.....	165
41349.....	132	41572.....	253	42248.....	488	42441.....	121	42556.....	127	42674.....	137	42791.....	149	42916.....	166
41357.....	132	41575.....	253	42252.....	62	42442.....	121	42557.....	127	42675.....	138	42792.....	149	42917.....	166
41359.....	133	41579.....	253	42254.....	62	42443.....	121	42559.....	127	42676.....	138	42793.....	148	42918.....	166
41360.....	133	41582.....	253	42255.....	62	42444.....	121	42560.....	127	42677.....	138	42794.....	148	42920.....	166
41362.....	100	41584.....	253	42257.....	228	42445.....	121	42562.....	127	42678.....	138	42795.....	149	42921.....	166
41363.....	100	41586.....	253	42261.....	228	42447.....	121	42563.....	127	42679.....	138	42796.....	149	42923.....	166
41364.....	133	41589.....	253	42262.....	228	42452.....	122	42564.....	128	42680.....	138	42797.....	149	42924.....	166
41365.....	133	41592.....	253	42263.....	228	42453.....	122	42566.....	128	42681.....	138	42798.....	149	42925.....	166
41366.....	133	41593.....	253	42269.....	228	42454.....	118	42567.....	128	42682.....	138	42799.....	71	42926.....	166
41367.....	133	41594.....	253	42271.....	228	42455.....	118	42568.....	128	42685.....	138	42800.....	71	42928.....	166
41368.....	133	41595.....	253	42272.....	228	42457.....	122	42569.....	128	42686.....	75	42801.....	150	42929.....	166
41369.....	133	41596.....	253	42273.....	228	42458.....	122	42570.....	128	42687.....	138	42802.....	150	42933.....	62
41370.....	133	41597.....	253	42283.....	228	42459.....	122	42571.....	128	42691.....	138	42803.....	150	42934.....	62
41371.....	133	41598.....	253	42284.....	228	42462.....	123	42576.....	128	42692.....	138	42804.....	150	42937.....	62
41372.....	133	41599.....	253	42290.....	228	42463.....	123	42577.....	128	42693.....	138	42806.....	150	42938.....	62
41373.....	133	41772.....	260	42293.....	228	42464.....	123	42578.....	128	42694.....	138	42807.....	150	42941.....	62
41374.....	133	41889.....	100	42294.....	228	42465.....	123	42579.....	128	42695.....	138	42808.....	150	42942.....	62
41375.....	133	41890.....	100	42300.....	401	42468.....	124	42582.....	128	42696.....	138	42809.....	151	42948.....	62
41455.....	253	41920.....	244	42301.....	401	42469.....	124	42583.....	128	42697.....	138	42810.....	151	42949.....	62
41456.....	253	41920.....	400	42302.....	401	42471.....	124	42584.....	129	42698.....	138	42811.....	151	42950.....	62
41457.....	253	41921.....	244	42303.....	401	42472.....	124	42585.....	129	42699.....	138	42812.....	151	42951.....	62
41458.....	253	41921.....	400	42304.....	401	42473.....	124	42587.....	129	42700.....	139	42816.....	151	42952.....	62
41459.....	253	41922.....	244	42305.....	401	42474.....	124	42588.....	129	42701.....	139	42817.....	151	42953.....	62
41460.....	253	41922.....	400	42306.....	401	42475.....	124	42589.....	129	42702.....	139	42819.....	152	42954.....	62
41461.....	253	41923.....	244	42307.....	401	42476.....	124	42592.....	129	42703.....	139	42820.....	152	42986.....	62
41462.....	253	41923.....	400	42331.....	260	42478.....	124	42594.....	129	42704.....	139	42821.....	152	42993.....	145
41463.....	253	41924.....	244	42332.....	260	42480.....	124	42595.....	129	42705.....	139	42822.....	152	42994.....	145
41464.....	253	41924.....	400	42335.....	260	42481.....	124	42600.....	129	42707.....	139	42823.....	152	42995.....	64
41465.....	253	41925.....	244	42336.....	133	4									

# Part Number Index

BradyID.com/s34

Catalog #	Pg	Catalog #	Pg	Catalog #	Pg	Catalog #	Pg	Catalog #	Pg	Catalog #	Pg	Catalog #	Pg	Catalog #	Pg	Catalog #	Pg
43120.....	89	43241.....	68	43364.....	89	43496.....	64	44255.....	220	44759.....	243	45096.....	49	45373.....	115	46990.....	138
43122.....	89	43242.....	68	43369.....	176	43497.....	125	44256.....	220	44979.....	48	45097.....	39	45375.....	114	46993.....	139
43128.....	89	43243.....	69	43372.....	176	43499.....	66	44257.....	220	44980.....	48	45099.....	38	45376.....	115	47000.....	62
43125.....	89	43244.....	69	43375.....	176	43500.....	121	44258.....	220	44981.....	41	45100.....	38	45377.....	115	47002.....	62
43127.....	90	43245.....	69	43378.....	176	43502.....	77	44259.....	220	44982.....	41	45102.....	36	45378.....	115	47004.....	62
43128.....	90	43246.....	69	43381.....	29	43504.....	137	44260.....	220	44983.....	47	45103.....	48	45379.....	113	47005.....	89
43129.....	90	43247.....	69	43382.....	177	43505.....	70	44301.....	220	44984.....	47	45104.....	48	45381.....	97	47006.....	30
43129.....	90	43248.....	69	43383.....	177	43507.....	68	44302.....	220	44985.....	48	45105.....	48	45422.....	113	47008.....	30
43130.....	90	43249.....	136	43384.....	177	43508.....	69	44304.....	220	44989.....	37	45106.....	48	45427.....	89	47010.....	136
43134.....	90	43250.....	136	43392.....	126	43510.....	70	44306.....	220	44990.....	37	45107.....	37	45428.....	89	47014.....	62
43139.....	90	43251.....	69	43396.....	177	43511.....	108	44307.....	220	44992.....	44	45108.....	37	45431.....	170	47018.....	145
43140.....	90	43254.....	100	43400.....	177	43514.....	64	44308.....	220	44993.....	45	45109.....	39	45470.....	30	47022.....	126
43141.....	90	43255.....	100	43401.....	177	43517.....	84	44310.....	220	44994.....	45	45110.....	39	45471.....	30	47024.....	69
43142.....	90	43256.....	100	43402.....	177	43518.....	84	44311.....	220	44995.....	49	45111.....	48	45472.....	30	47034.....	93
43143.....	88	43257.....	100	43403.....	177	43519.....	119	44313.....	220	44996.....	49	45112.....	48	45474.....	178	47035.....	93
43144.....	88	43258.....	100	43405.....	177	43747.....	84	44314.....	220	44999.....	48	45113.....	48	46237.....	39	47039.....	104
43145.....	88	43265.....	165	43406.....	177	43748.....	84	44315.....	220	45000.....	48	45115.....	48	46346.....	220	47040.....	93
43146.....	88	43267.....	100	43407.....	177	43753.....	84	44327.....	220	45001.....	48	45116.....	48	46347.....	220	47044.....	107
43147.....	151	43268.....	100	43408.....	177	43754.....	84	44328.....	220	45004.....	37	45117.....	41	46348.....	220	47050.....	144
43148.....	151	43269.....	100	43409.....	177	43758.....	84	44329.....	220	45008.....	37	45118.....	41	46349.....	220	47056.....	143
43151.....	151	43272.....	101	43410.....	177	43759.....	84	44331.....	220	45009.....	49	45119.....	47	46454.....	43	47058.....	120
43152.....	151	43274.....	101	43411.....	177	43760.....	84	44332.....	220	45011.....	44	45121.....	48	46458.....	43	47059.....	143
43153.....	151	43277.....	101	43412.....	177	43906.....	33	44333.....	220	45012.....	44	45122.....	48	46459.....	46	47060.....	120
43154.....	151	43278.....	101	43413.....	177	43979.....	77	44338.....	220	45013.....	49	45123.....	45	46460.....	42	47061.....	144
43155.....	151	43279.....	101	43415.....	177	43983.....	77	44342.....	220	45015.....	41	45124.....	45	46461.....	42	47064.....	145
43156.....	151	43281.....	101	43416.....	177	44099.....	220	44347.....	220	45017.....	48	45125.....	37	46464.....	38	47075.....	86
43157.....	152	43282.....	101	43421.....	178	44100.....	220	44359.....	220	45018.....	48	45126.....	37	46471.....	37	47093.....	28
43158.....	152	43283.....	101	43422.....	178	44101.....	220	44360.....	220	45019.....	43	45127.....	44	46473.....	37	47094.....	143
43159.....	152	43284.....	101	43423.....	178	44102.....	220	44400.....	244	45020.....	43	45129.....	45	46474.....	48	47100.....	144
43160.....	152	43285.....	102	43424.....	179	44104.....	220	44401.....	244	45021.....	47	45131.....	49	46477.....	37	47101.....	145
43161.....	152	43286.....	102	43425.....	179	44106.....	220	44402.....	244	45022.....	47	45132.....	49	46479.....	39	47113.....	86
43162.....	152	43287.....	102	43426.....	180	44107.....	220	44403.....	244	45023.....	40	45133.....	49	46480.....	39	47115.....	132
43168.....	153	43288.....	102	43427.....	180	44108.....	220	44702.....	243	45024.....	40	45136.....	48	46481.....	48	47116.....	134
43171.....	143	43289.....	102	43428.....	180	44110.....	220	44703.....	243	45025.....	39	45138.....	48	46482.....	48	47117.....	64
43172.....	143	43290.....	103	43429.....	181	44111.....	220	44704.....	243	45026.....	39	45139.....	37	46483.....	48	47124.....	122
43173.....	121	43291.....	103	43430.....	181	44112.....	220	44705.....	243	45028.....	49	45140.....	37	46484.....	48	47146.....	89
43174.....	121	43292.....	104	43431.....	181	44113.....	220	44706.....	243	45029.....	39	45141.....	48	46486.....	48	47148.....	69
43175.....	122	43293.....	104	43432.....	181	44114.....	220	44707.....	243	45031.....	38	45143.....	37	46489.....	49	47152.....	30
43176.....	122	43294.....	104	43434.....	182	44115.....	220	44708.....	243	45032.....	38	45144.....	37	46491.....	46	47158.....	148
43177.....	122	43295.....	104	43435.....	182	44116.....	220	44709.....	243	45033.....	36	45145.....	49	46579.....	41	47159.....	127
43178.....	122	43297.....	103	43436.....	183	44118.....	220	44710.....	243	45034.....	48	45146.....	49	46581.....	44	47160.....	127
43181.....	122	43298.....	103	43437.....	177	44121.....	220	44711.....	243	45039.....	37	45147.....	44	46620.....	48	47161.....	128
43182.....	122	43299.....	103	43438.....	177	44122.....	220	44712.....	243	45040.....	37	45148.....	44	46626.....	38	47162.....	128
43183.....	122	43300.....	105	43439.....	183	44124.....	220	44713.....	243	45041.....	39	45150.....	49	46635.....	49	47169.....	90
43184.....	122	43302.....	105	43440.....	183	44125.....	220	44714.....	243	45042.....	39	45151.....	41	46641.....	41	47170.....	90
43185.....	123	43303.....	105	43442.....	184	44126.....	220	44715.....	243	45045.....	48	45153.....	48	46643.....	44	47171.....	136
43186.....	123	43304.....	105	43445.....	177	44127.....	220	44716.....	243	45047.....	48	45154.....	48	46644.....	47	47172.....	139
43187.....	123	43305.....	104	43447.....	184	44129.....	220	44717.....	243	45048.....	48	45155.....	43	46645.....	42	47189.....	148
43188.....	123	43306.....	104	43448.....	186	44131.....	220	44718.....	243	45050.....	41	45156.....	43	46646.....	43	47192.....	127
43189.....	123	43307.....	105	43449.....	186	44132.....	220	44719.....	243	45052.....	47	45157.....	47	46647.....	43	47195.....	89
43190.....	123	43311.....	72	43450.....	187	44133.....	220	44720.....	243	45053.....	48	45158.....	47	46661.....	48	47196.....	84
43191.....	124	43312.....	72	43451.....	178	44134.....	220	44721.....	243	45054.....	48	45159.....	40	46664.....	48	47198.....	84
43192.....	124	43315.....	73	43452.....	187	44138.....	220	44722.....	243	45055.....	46	45161.....	39	46670.....	38	47203.....	137
43195.....	126	43316.....	73	43454.....	119	44149.....	220	44723.....	243	45056.....	46	45162.....	39	46674.....	37	47204.....	84
43196.....	126	43317.....	73	43455.....	66	44151.....	220	44724.....	243	45057.....	37	45163.....	49	46679.....	49	47206.....	66
43197.....	126	43318.....	73	43458.....	87	44155.....	220	44725.....	243	45058.....	37	45164.....	49	46687.....	44	47239.....	277
43198.....	126	43319.....	61	43461.....	139	44157.....	220	44726.....	243	45059.....	44	45165.....	39	46688.....	47	47240.....	277
43200.....	125	43320.....	61	43462.....	62	44158.....	220	44727.....	243	45060.....	44	45166.....	39	46689.....	42	47243.....	277
43202.....	127	43322.....	75	43464.....	177	44159.....	220	44728.....	243	45063.....	49	45167.....	38	46690.....	43	47246.....	103
43203.....	151	43323.....	76	43465.....	179	44160.....	220	44729.....	243	45064.....	49	45168.....	38	46691.....	43	47247.....	103
43204.....	151	43324.....	132	43466.....	179	44201.....	220	44730.....	243	45065.....	49	45171.....	48	46731.....	43	47251.....	277
43208.....	129	43325.....	132	43467.....	181	44202.....	220	44732.....	243	45067.....	48	45172.....	48	46732.....	44	47273.....	101
43209.....	129	43328.....	132	43468.....	144	44204.....	220	44733.....	243	45068.....	48	45173.....	48	46733.....	45	47279.....	104
43210.....	129	43329.....	132	43469.....	144	44206.....	220	44734.....	243	45069.....	48	45175.....	37	46735.....	43	47288.....	93
43211.....	130	43331.....	132	43470.....	145	44207.....	220	44735.....	243	45071.....	37	45176.....	37	46736.....	46	47305.....	150
43212.....	130	43332.....	132	43471.....	145	44208.....	220	44736.....	243	45072.....	37	45177.....	39	46737.....	42	47307.....	151
43213.....	130	43333.....	132	43472.....	147	44210.....	220	44737.....	243	45073.....	48	45178.....	39	46738.....	42	47327.....	31
43214.....	130	43336.....	132	43473.....	148	44211.....	220	44738.....	243	45074.....	48	45179.....	48	46741.....	38	47329.....	177
43215.....	130	43337.....	132	43474.....	89	44212.....	220	44739.....	243	45075.....	37	45180.....	48	46748.....	37	47330.....	32
43216.....	130	43338.....	91	43475.....	68	44213.....	220	44740.....	243	45076.....	37	45190.....	472	46750.....	37	47332.....	150
43217.....	100	43339.....	91	43476.....	153	44214.....	220	4474									

Catalog #	Pg	Catalog #	Pg	Catalog #	Pg	Catalog #	Pg	Catalog #	Pg	Catalog #	Pg	Catalog #	Pg	Catalog #	Pg	Catalog #	Pg	Catalog #	Pg
47555	159	48884	78	49116	166	50684	113	51291	468	55262	259	56960	271	57980	249	58511	208		
47579	142	48885	78	49117	166	50685	114	51292	468	55263	259	56961	229	57981	249	58515	208		
47587	142	48886	78	49227	232	50688	113	51297	468	55290	270	56962	229	57982	249	58621	77		
47593	142	48887	78	49228	232	50689	113	51298	468	55290	270	56962	229	57983	249	58656	208		
47595	142	48888	78	49234	232	50691	114	51299	468	55291	270	56962	271	57984	249	58706	385		
47606	142	48889	78	49550	228	50692	114	51339	466	55291	270	56968	162	57985	249	58763	64		
47612	142	48890	78	49551	228	50693	114	51344	466	55292	270	56970	161	57986	249	58764	64		
47618	133	48891	78	49552	228	50694	114	51345	466	55293	270	56972	160	57987	249	58973	245		
47632	142	48892	78	49553	228	50695	114	51346	466	55294	270	56973	160	57988	249	59102	99		
47636	142	48893	78	49554	228	50696	114	51347	466	55294	270	57001	171	57989	249	59109	99		
47638	142	48894	78	49555	228	50697	114	51353	466	55295	270	57002	171	57990	249	59111	99		
47639	142	48895	78	49556	228	50698	114	51360	469	55295	270	57004	171	57991	249	59112	99		
47643	59	48896	78	49557	228	50777	113	51361	469	55296	270	57005	171	57992	249	59114	99		
47645	59	48897	78	49558	228	50778	113	51362	469	55297	270	57006	171	57993	249	59122	99		
47646	59	48898	78	49559	228	50783	113	51363	469	55300	270	57014	171	57994	249	59277	99		
47649	142	48899	78	49560	228	50784	114	51368	469	55300	270	57016	171	57995	249	59279	99		
47651	142	48966	48	49561	228	50785	113	51369	469	55301	270	57017	171	57996	249	59283	99		
47652	142	48967	48	49562	228	50786	113	51370	469	55301	270	57018	171	57997	249	59289	99		
47655	59	48968	48	49563	228	50899	476	51371	469	55302	270	57020	171	57998	249	59293	99		
47657	59	48972	47	49564	228	50900	162	51376	469	55303	270	57021	171	57999	249	59298	99		
47658	59	48974	48	49565	228	50901	162	51377	469	55312	270	57022	171	58000	249	59299	99		
47668	159	48975	45	49566	228	50902	162	51378	469	55312	270	57023	171	58001	249	59301	99		
47670	159	48976	45	49567	228	50903	162	51379	470	55313	270	57026	171	58002	249	59302	99		
47671	159	48977	37	49568	228	50904	160	51388	476	55314	270	57029	171	58003	249	59303	99		
47674	159	48978	37	49569	228	50905	160	51390	476	55358	271	57030	171	58004	249	59304	99		
47676	159	48979	44	49570	228	50906	160	51392	476	55359	271	57031	171	58005	249	59305	99		
47677	159	48980	44	49571	228	50907	161	51394	476	55364	259	57032	171	58006	249	59306	99		
47685	159	48983	49	49572	228	50908	160	51395	476	55365	259	57033	171	58007	249	59307	99		
47690	159	48984	49	49573	228	50909	161	51442	475	55368	259	57034	171	58008	249	59308	99		
47691	159	48987	48	49574	228	50910	160	51447	389	55371	259	57036	171	58009	249	59310	99		
47699	159	48988	48	49576	228	50911	162	51448	396	55775	192	57037	171	58010	249	59312	99		
47701	159	48989	48	49577	228	50912	162	51454	489	55784	192	57038	171	58011	249	59314	99		
47708	159	48990	48	49578	228	50924	476	51455	489	56681	192	57045	171	58012	249	59316	99		
47713	159	48991	37	49579	228	50932	476	51544	489	56687	192	57050	171	58013	249	59329	93		
47721	159	48992	37	49580	228	50937	473	51545	401	56688	192	57067	171	58014	249	59330	99		
47722	159	48995	37	49581	228	50938	473	51546	402	56691	133	57067	171	58015	249	59335	99		
47725	159	48996	37	49801	110	50939	473	51547	106	56694	192	57069	171	58016	249	59336	99		
47727	159	48998	49	49805	110	50940	475	51549	106	56699	171	57069	171	58017	249	59341	99		
47728	159	48999	44	49806	110	50941	475	51550	106	56726	171	57070	171	58200	270	59342	99		
47731	159	49001	49	49807	110	50943	475	51551	93	56727	171	57070	171	58201	270	59345	99		
47733	159	49003	41	49900	244	50944	475	51552	93	56750	171	57071	171	58202	270	59346	99		
47734	159	49004	41	49901	244	50945	475	51555	103	56767	171	57071	171	58203	270	59349	99		
48111	238	49005	48	49902	244	50947	475	51556	103	56789	171	57072	171	58220	270	59350	99		
48112	238	49006	48	49903	244	50948	475	51584	395	56791	171	57072	171	58220	270	59379	90		
48840	78	49008	43	49904	244	50950	475	51585	395	56795	171	57073	193	58221	270	59380	90		
48841	78	49009	47	49905	244	50951	475	51586	395	56798	171	57079	142	58221	270	59381	90		
48842	78	49010	47	49906	244	50953	475	51793	489	56799	171	57080	142	58222	270	59382	89		
48843	78	49011	49	49907	244	50954	475	52041	348	56800	171	57084	142	58222	270	59383	89		
48845	78	49013	39	49908	244	50956	475	52042	351	56818	171	57445	193	58223	270	59384	89		
48846	78	49014	39	49909	244	50961	492	52044	351	56897	171	57446	193	58250	270	59385	89		
48847	78	49015	49	50010	216	50962	492	52045	351	56905	93	57502	193	58250	270	59386	89		
48848	78	49016	49	50011	216	50979	451	52047	351	56907	93	57593	193	58251	270	59387	89		
48849	78	49017	39	50012	216	50989	456	52059	351	56908	93	57594	193	58251	270	59388	95		
48850	78	49018	39	50013	216	50990	457	52148	349	56926	237	57596	193	58252	270	59389	95		
48851	78	49019	38	50014	216	50991	457	52149	349	56927	237	57597	193	58252	270	59391	95		
48852	78	49020	38	50015	216	50992	457	52150	349	56928	237	57599	193	58253	270	59395	71		
48853	78	49021	36	50016	216	50993	454	52152	349	56929	237	57624	166	58253	270	59397	71		
48854	78	49024	48	50017	216	50994	454	52153	350	56930	237	57624	215	58255	272	59404	74		
48855	78	49026	48	50018	216	50995	454	52155	350	56931	237	57627	193	58257	272	59506	127		
48856	78	49027	37	50019	216	50996	454	52156	350	56932	237	57630	193	58268	208	59507	127		
48857	78	49029	39	50020	216	50997	454	52157	350	56933	237	57754	192	58272	208	59508	127		
48858	78	49030	39	50053	208	50998	71	52158	350	56934	237	57755	192	58273	208	59529	392		
48859	78	49032	48	50054	208	51171	472	52203	217	56935	237	57771	193	58274	208	59530	392		
48860	78	49035	112	50055	208	51172	451	52204	217	56936	237	57892	192	58300	190	59531	392		
48861	78	49041	113	50056	208	51173	451	52207	217	56937	237	57893	192	58301	190	59532	392		
48862	78	49042	115	50193	488	51181	456	52208	217	56938	237	57894	192	58342	275	59918	260		
48863	78	49043	115	50198	461	51186	456	52210	217	56939	237	57895	192	58343	275	59919	401		
48864	78	49044	113	50199	461	51187	457	52211	217	56940	237	57960	249	58344	275	59918	249		
48865	78	49045	115	50248	232	51188	457	52212	217	56941	237	57961	249	58345	275	59920	249		
48866	78	49057	110	50250	461	51189	457	52213	217	56941	237	57962	249	58346	275	59921	249		
48867	78	49058	110	50258	461	51194	457	52214	217	56942	237	57963	249	58347	275	59922	249		
48868	78	49060	110	50261	461	51195	457	52215	217	56942	237	57964	249	58348	275	59923	249		
48869	78	49061	110	50269	118	51196	457	52216	217	56944	237	57965	249	58349	275	59924	249		
48870	78	49062	110	50270															

# Part Number Index

BradyID.com/s34

Part Number Index

Catalog #	Pg	Catalog #	Pg	Catalog #	Pg	Catalog #	Pg	Catalog #	Pg	Catalog #	Pg	Catalog #	Pg	Catalog #	Pg	Catalog #	Pg	Catalog #	Pg
59939	249	60245	227	60380	80	62810	48	63371	79	64732	399	65522	461	66004	493	69168	101		
59940	249	60246	227	60382	80	62812	61	63372	79	64733	399	65523	461	66005	118	69170	125		
59941	249	60247	227	60383	80	62813	37	63373	79	64735	399	65524	461	66006	118	69173	165		
59942	249	60248	227	60384	80	62816	39	63375	79	64736	399	65525	461	66007	118	69176	177		
59943	249	60249	227	60387	80	62817	48	63376	79	64737	399	65526	461	66008	118	69179	150		
59944	249	60250	227	60388	80	62818	48	63377	79	64739	398	65527	461	66009	493	69182	151		
59946	260	60251	227	60390	80	62822	48	63378	79	64740	398	65534	461	66010	118	69183	150		
59955	81	60252	227	60391	80	62827	46	63379	79	64741	398	65535	461	66011	118	69184	148		
59956	81	60253	227	60394	80	62866	41	63381	79	64776	399	65555	489	66012	493	69190	90		
59980	249	60254	227	60398	80	62868	44	63383	79	64984	385	65560	477	66013	118	69192	89		
59981	249	60255	227	60400	80	62950	155	63384	79	64985	385	65561	477	66014	493	69193	30		
59982	249	60256	227	60402	80	62951	155	63385	79	65039	145	65562	477	66015	461	69196	128		
60141	81	60257	227	60403	80	62952	155	63386	79	65040	472	65563	477	66016	461	69199	92		
60142	81	60258	227	60404	80	62954	155	63387	79	65043	441	65564	477	66017	461	69202	101		
60143	81	60259	227	60407	80	63004	488	63389	79	65159	62	65570	118	66018	461	69206	101		
60161	119	60260	227	60410	80	63009	275	63390	79	65240	471	65571	118	66019	461	69210	31		
60162	118	60261	226	60412	80	63050	275	63392	79	65241	471	65575	118	66020	461	69215	152		
60167	119	60262	226	60413	80	63200	81	63393	79	65261	62	65576	118	66021	461	69221	75		
60170	118	60263	226	60414	80	63203	176	63394	79	65262	62	65585	477	66022	461	69226	144		
60172	118	60264	226	60416	80	63204	176	63395	79	65263	62	65586	477	66023	461	69228	65		
60173	118	60265	226	60419	80	63207	180	63396	79	65264	62	65587	477	66024	461	69229	144		
60174	118	60266	226	60421	80	63208	176	63399	79	65266	62	65588	477	66025	461	69232	108		
60175	118	60267	226	60423	80	63210	180	63400	79	65269	486	65589	477	66026	461	69237	125		
60176	118	60268	226	60425	80	63212	80	63403	79	65270	232	65590	477	66027	461	69238	131		
60177	119	60269	226	60426	80	63213	81	63404	79	65273	213	65591	477	66028	461	69243	103		
60178	118	60270	226	60427	80	63214	81	63406	80	65279	486	65592	477	66029	461	69246	103		
60179	119	60271	226	60428	80	63240	209	63409	80	65280	213	65593	477	66030	461	69249	109		
60180	119	60272	226	60431	80	63300	79	63410	80	65289	486	65594	477	66031	461	69252	75		
60181	220	60273	226	60433	80	63301	79	63411	80	65299	444	65595	477	66032	461	69255	151		
60182	220	60274	226	60434	80	63302	79	63412	80	65319	443	65596	477	66033	461	69264	69		
60183	220	60275	226	60435	80	63303	79	63414	80	65318	475	65597	477	66034	461	69265	69		
60184	220	60276	226	60436	80	63304	79	63415	80	65319	475	65598	477	66035	461	69273	30		
60185	220	60277	226	60445	209	63306	79	63418	80	65319	475	65599	477	66036	461	69275	69		
60186	220	60278	226	60447	209	63307	79	63419	80	65320	475	65645	487	66037	461	69277	172		
60187	220	60279	226	60499	115	63308	79	63420	80	65321	483	65666	477	66038	461	69282	133		
60188	220	60280	226	60504	75	63310	79	63421	80	65329	483	65669	477	66039	461	69290	64		
60189	220	60281	226	60506	82	63311	79	63422	80	65347	230	65670	461	66040	461	69291	64		
60190	220	60282	226	60507	85	63312	79	63423	80	65349	230	65671	461	66041	461	69292	88		
60191	220	60283	226	60508	127	63313	79	63425	80	65350	230	65672	472	66042	132	69294	70		
60192	220	60284	226	60509	127	63314	79	63426	80	65350	230	65673	485	66043	132	69301	180		
60193	220	60285	226	60510	31	63316	79	63428	80	65371	233	65674	485	66044	89	69302	87		
60194	220	60286	226	60511	150	63317	79	63429	80	65372	230	65675	485	66045	89	69304	70		
60195	220	60287	226	60533	75	63318	79	63431	80	65373	230	65682	119	66046	89	69307	132		
60196	220	60288	226	60535	82	63320	79	63433	80	65375	474	65688	483	66047	125	69308	70		
60197	220	60289	226	60536	85	63321	79	63434	80	65376	474	65690	486	66048	121	69315	88		
60198	220	60290	226	60537	127	63322	79	63436	80	65387	483	65691	486	66049	89	69317	125		
60199	220	60291	226	60538	127	63323	79	63439	80	65392	485	65692	477	66050	30	69331	146		
60200	220	60292	226	60539	31	63324	79	63443	80	65396	483	65693	477	66051	89	69333	165		
60201	220	60293	226	60540	150	63325	79	63444	80	65397	483	65695	485	66052	89	69337	70		
60202	220	60294	226	60563	75	63326	79	63446	80	65402	476	65696	485	66053	64	69339	90		
60203	220	60295	226	60568	76	63327	79	63447	80	65403	476	65699	472	66054	67	69344	126		
60204	220	60296	226	60569	82	63328	79	63448	80	65404	483	65700	486	66055	134	69350	128		
60205	220	60297	226	60570	85	63331	79	63449	80	65405	443	65711	486	66056	124	69352	165		
60206	220	60298	226	60571	29	63332	79	63452	80	65406	483	65717	444	66057	177	69364	133		
60207	220	60299	226	60572	42	63333	79	63454	80	65407	461	65780	451	66058	177	69371	64		
60208	220	60300	226	60573	153	63334	79	63455	80	65408	461	65810	482	66059	120	69380	31		
60209	220	60301	226	60574	43	63336	79	63473	210	65440	461	65814	482	66060	67	69382	61		
60210	220	60302	226	60575	127	63337	79	64057	477	65441	461	65815	482	66061	102	69387	31		
60211	220	60303	226	60576	127	63339	79	64221	487	65442	461	65817	84	66062	104	69399	71		
60212	220	60304	226	60578	31	63340	79	64326	398	65443	461	65825	62	66063	124	69404	121		
60213	220	60305	226	60579	150	63341	79	64327	398	65444	461	65828	62	66064	130	69405	34		
60214	220	60306	226	60580	89	63342	79	64328	398	65445	461	65903	213	66065	132	69407	72		
60215	220	60307	226	62423	49	63344	79	64329	398	65446	461	65909	83	66066	107	69408	65		
60216	220	60308	226	62433	47	63345	79	64331	398	65447	461	65910	84	66067	68	69409	71		
60217	220	60309	226	62436	43	63346	79	64332	398	65448	461	65916	146	66068	120	69410	31		
60218	220	60310	226	62530	45	63347	79	64333	398	65450	461	65917	146	66069	86	69413	127		
60219	220	60311	226	62538	38	63348	79	64335	398	65451	461	65937	213	66070	33	69414	165		
60220	220	60312	226	62545	37	63349	79	64336	398	65452	461	65938	213	66071	29	69415	87		
60221	220	60313	226	62550	61	63350	79	64339	398	65453	461	65948	84	66072	33	69416	131		
60222	220	60314	226	62551	37	63351	79	64340	398	65454	461	65949	84	66073	176	69417	127		
60223	220	60315	226	62555	48	63352	79	6434											



Part Number Index

Table with 12 columns: Catalog #, Pg, Catalog #, Pg, Catalog #, Pg, Catalog #, Pg, Catalog #, Pg, Catalog #, Pg. Contains a comprehensive list of part numbers and page references.



# Part Number Index

BradyID.com/s34

Part Number Index

Catalog #	Pg	Catalog #	Pg	Catalog #	Pg	Catalog #	Pg	Catalog #	Pg	Catalog #	Pg	Catalog #	Pg	Catalog #	Pg
76600	383	76741	389	78084	62	80078	187	80274	92	82594	221	83756	39	84069	30
76601	383	76743	389	78086	62	80091	180	80275	92	82595	84	83757	39	84074	30
76602	383	76745	389	78091	272	80094	180	80276	92	82596	84	83758	48	84075	30
76603	383	76747	389	78092	272	80095	182	80277	92	83400	251	83759	48	84080	30
76604	383	76749	389	78146	272	80097	178	80278	92	83413	251	83760	48	84081	30
76605	383	76751	389	78147	272	80098	182	80279	92	83414	251	83761	48	84082	30
76606	383	76752	389	78148	272	80099	184	80280	92	83415	251	83763	48	84083	30
76607	383	76759	389	78149	272	80100	179	80281	93	83416	251	83764	48	84084	30
76608	383	76760	389	78150	272	80101	178	80282	93	83418	251	83766	49	84085	30
76609	383	76761	389	78160	272	80102	178	80283	93	83421	251	83767	49	84086	30
76610	383	76762	389	78161	272	80103	178	80284	93	83424	251	83768	46	84089	30
76611	383	76763	389	78162	272	80104	178	80285	93	83430	251	83839	41	84090	30
76612	383	76766	389	78163	272	80105	182	80286	93	83432	251	83841	44	84091	30
76613	383	76767	389	78167	272	80106	183	80287	93	83436	251	83874	48	84092	30
76614	383	76770	389	78188	272	80108	181	80288	93	83448	251	83877	48	84095	30
76615	383	76771	389	78189	272	80109	182	80289	93	83449	251	83883	38	84096	30
76616	383	76774	389	78190	272	80110	172	80290	93	83450	251	83887	37	84097	30
76617	383	76775	389	78191	272	80111	193	80291	102	83451	251	83892	49	84101	30
76618	383	76778	389	78193	272	80111	278	80292	102	83453	251	83896	41	84103	31
76619	383	76779	389	78194	272	80112	193	80294	102	83456	251	83898	44	84104	31
76620	383	76782	389	78195	272	80112	278	80296	103	83460	251	83899	47	84107	30
76621	383	76786	389	78196	272	80117	278	80297	103	83466	251	83900	42	84108	31
76622	383	76787	389	78197	272	80118	278	80298	102	83468	251	83901	43	84110	31
76623	383	76790	389	78198	272	80125	278	80299	102	83477	251	83902	43	84111	31
76624	383	76791	389	78199	272	80127	278	80460	104	83478	251	83907	44	84112	31
76625	383	76794	389	78227	133	80129	278	80702	114	83479	251	83908	45	84113	31
76626	383	76795	389	78234	276	80130	278	80703	114	83484	251	83910	43	84114	31
76627	383	76800	381	78235	276	80131	278	80704	113	83489	251	83911	46	84115	31
76628	383	76801	381	78238	276	80160	105	80705	115	83496	251	83912	42	84119	31
76629	383	76802	381	78239	276	80161	102	80716	77	83498	251	83913	42	84120	31
76630	383	76808	381	78241	276	80162	104	80717	77	83501	251	83916	38	84122	31
76631	383	76811	381	78246	276	80167	103	80735	99	83505	251	83923	37	84123	31
76632	383	76870	105	78247	276	80173	104	80753B	97	83510	251	83925	37	84124	31
76633	383	76871	172	78248	276	80174	104	80754B	97	83514	251	83928	61	84129	31
76634	383	76879	158	78254	276	80201	91	80755B	97	83515	251	83929	37	84130	31
76635	383	77198	277	78257	276	80202	91	80756B	97	83517	251	83931	39	84131	31
76636	383	77199	277	78258	276	80204	89	80885	99	83520	251	83932	39	84132	31
76637	383	77200	277	78259	276	80207	92	80899	99	83522	251	83933	48	84133	31
76638	383	77201	277	78260	104	80208	92	80903	99	83527	251	83934	48	84134	31
76639	383	77202	277	78261	193	80209	92	80937	276	83530	251	83935	48	84138	31
76640	383	77203	277	78262	193	80210	92	80938	276	83537	251	83936	48	84140	31
76641	383	77204	277	78263	193	80211	92	80940	276	83540	251	83938	48	84141	31
76642	383	77205	277	78264	193	80212	92	80942	276	83545	251	83939	48	84142	31
76643	383	77207	277	78268	276	80213	92	80943	276	83550	251	83941	49	84143	31
76644	383	77208	277	78272	190	80214	92	80944	276	83551	251	83942	49	84144	31
76645	383	77210	277	78273	190	80215	93	80946	276	83553	251	83943	46	84146	31
76646	383	77210	277	78278	208	80217	93	80947	276	83556	251	83954	41	84149	31
76647	383	77216	277	78985	270	80218	93	80948	276	83558	251	83956	44	84150	31
76648	383	77217	277	78986	270	80219	93	80958	276	83563	251	84002	28	84151	31
76649	383	77219	277	78987	270	80220	93	80959	276	83566	251	84003	28	84152	31
76650	383	77221	277	78988	270	80221	93	80960	276	83573	251	84006	28	84153	31
76651	383	77224	277	78989	270	80222	93	80961	276	83576	251	84007	28	84154	31
76652	383	77226	277	78990	270	80223	102	81728	253	83585	251	84008	28	84155	31
76653	383	77227	277	78991	191	80225	102	81729	273	83589	251	84009	28	84156	31
76654	383	77228	277	78992	191	80227	103	81760	463	83590	251	84010	28	84159	31
76686	388	77995	62	78993	191	80229	102	81761	463	83596	251	84011	28	84160	31
76687	388	77997	62	78995	190	80231	103	81762	463	83598	251	84012	28	84167	31
76688	388	77998	62	78996	190	80232	103	81762	463	83599	251	84013	28	84168	31
76689	388	77999	62	78997	190	80233	102	81763	235	83600	251	84014	28	84171	31
76691	388	78000	170	78998	190	80234	102	81764	236	83601	251	84015	28	84172	31
76692	388	78002	170	78999	190	80235	103	81765	237	83604	251	84018	28	84173	31
76693	388	78003	170	79000	190	80237	104	81765	237	83607	251	84019	28	84174	31
76694	388	78004	170	80007	100	80241	104	81766	243	83612	251	84026	28	84175	31
76695	388	78007	170	80009	100	80242	103	81766	243	83615	251	84027	28	84176	31
76696	388	78009	170	80017	100	80243	104	81767	237	83654	48	84032	29	84177	137
76697	388	78010	170	80027	94	80244	105	81767	237	83658	48	84033	29	84178	137
76698	388	78011	170	80028	94	80245	109	81768	237	83660	38	84034	29	84179	33
76699	388	78013	170	80029	95	80247	94	81768	463	83664	37	84035	29	84181	33
76700	388	78014	170	80035	95	80248	138	81769	237	83669	49	84036	29	84182	33
76701	388	78015	170	80037	33	80249	138	81769	463	83675	41	84037	29	84183	33
76702	388	78016	170	80040	95	80250	94	81770	237	83677	44	84038	29	84184	33
76703	388	78018	170	80041	95	80253	94	81770	463	83678	47	84039	29	84185	33
76704	388	78019	170	80048	95	80254	94	81771	233	83679	42	84042	29	84186	33
76705	387	78031	170	80049	172	80255	94	81772	234	83680	43	84043	29	84187	33
76706	387	78033	170	80055	178	80256	95	81773	463	83681	43	84054	29	84188	33
76707	387	78035	170	80060	178	80257	95	81869	273	83731	43	84055	29	84189	33
76711	386	78036	170	80061	180	80259	95	81873	273	83732	44	84056	29	84190	33
76712	386	78037	169	80067	178	80261	94	81963	222	83733	45	84057	29	84191	33
76713	386	78047	170	80068	178	80262	95	81991	234	83735	43	84060	29	84192	33
76714	387	78049	170	80070	178	80264	95	82586	221	83736	46	84061	29	84195	33
76715	387	78055	170	80071	187	80266	95	82587	221	83737	42	84062	29	84196	33
76716	387	78063	162	80072	187	80267	91	82588	221	83738	42	84063	29	84197	33
76720	388	78064	62	80073	185	80268	91	82589	221	83741	38	84064	29	84198	33
76721	388	78066	62	80074	185	80269	89	82590	221	83748					

Catalog #	Pg	Catalog #	Pg	Catalog #	Pg	Catalog #	Pg	Catalog #	Pg	Catalog #	Pg	Catalog #	Pg	Catalog #	Pg
84355	67	84535	145	84686	94	84805	148	84966	90	85101	124	85265	103	85444	66
84356	67	84536	145	84687	94	84806	148	84967	90	85102	124	85267	103	85445	67
84357	67	84537	145	84688	94	84807	148	84968	90	85115	126	85268	103	85452	67
84358	67	84538	145	84689	95	84808	150	84971	143	85116	126	85269	103	85453	67
84361	67	84542	82	84690	95	84809	150	84972	143	85117	126	85270	105	85458	68
84362	67	84545	146	84692	86	84810	150	84973	143	85118	126	85271	105	85459	68
84363	67	84546	146	84695	86	84811	150	84975	143	85119	125	85272	105	85463	105
84364	67	84547	146	84696	86	84812	150	84976	143	85120	125	85273	105	85476	105
84366	67	84548	153	84697	86	84813	150	84977	143	85129	151	85275	104	85478	109
84368	67	84549	153	84698	86	84814	150	84981	144	85130	151	85276	104	85480	94
84369	67	84550	153	84699	86	84815	150	84982	144	85133	129	85277	104	85481	94
84370	67	84551	152	84700	86	84816	150	84983	144	85134	129	85278	104	85482	138
84371	67	84552	153	84702	86	84817	150	84984	144	85135	129	85279	105	85483	138
84372	67	84553	154	84703	86	84818	151	84987	146	85136	129	85280	105	85484	94
84375	68	84554	154	84704	86	84822	152	84989	146	85139	130	85294	100	85485	69
84376	68	84555	153	84705	86	84823	152	84990	146	85140	130	85297	106	85486	69
84379	68	84556	146	84706	86	84824	153	84991	147	85141	130	85298	106	85489	69
84387	69	84557	146	84707	86	84825	153	84992	147	85142	130	85299	106	85490	69
84388	69	84562	70	84708	121	84826	153	84993	147	85143	130	85305	106	85493	69
84393	69	84563	70	84710	86	84827	88	84994	147	85144	130	85308	107	85497	69
84394	69	84564	83	84711	86	84828	88	84995	147	85145	131	85309	107	85498	69
84395	69	84566	29	84712	86	84829	88	84996	147	85147	131	85310	107	85499	69
84396	69	84567	70	84713	86	84830	88	84997	147	85148	100	85311	107	85500	69
84397	69	84568	70	84714	86	84831	88	84998	147	85151	100	85312	107	85512	70
84398	69	84569	29	84715	86	84832	88	84999	147	85152	100	85315	107	85521	71
84399	69	84570	29	84716	86	84834	88	85000	147	85161	68	85316	107	85522	71
84400	69	84571	29	84717	86	84837	88	85001	147	85162	68	85321	107	85523	94
84403	69	84572	29	84718	86	84838	88	85002	147	85165	68	85322	107	85528	94
84407	70	84575	84	84719	86	84843	88	85003	148	85166	68	85323	107	85531	72
84408	70	84577	84	84720	86	84844	88	85007	148	85167	68	85324	107	85532	72
84409	70	84583	156	84721	86	84847	88	85008	148	85168	68	85325	107	85533	72
84411	70	84586	156	84725	86	84848	88	85011	148	85169	68	85326	107	85534	72
84412	70	84601	158	84726	86	84851	88	85015	148	85170	68	85327	107	85535	72
84421	70	84602	158	84727	86	84852	88	85016	148	85174	30	85328	107	85536	72
84422	70	84603	158	84730	86	84853	88	85017	149	85175	68	85331	108	85540	94
84423	70	84604	158	84732	31	84855	88	85018	149	85176	68	85332	108	85541	94
84425	70	84605	158	84733	31	84856	88	85021	149	85179	68	85333	108	85545	94
84426	70	84617	91	84736	32	84857	88	85027	149	85180	68	85334	108	85546	95
84427	70	84618	91	84737	32	84859	88	85028	149	85181	68	85337	108	85547	73
84428	71	84619	91	84738	86	84860	88	85029	150	85182	68	85338	108	85548	73
84429	71	84621	91	84739	86	84865	89	85030	150	85183	69	85343	108	85549	73
84430	71	84622	91	84740	86	84875	89	85032	150	85184	69	85344	108	85550	73
84431	71	84625	92	84741	86	84876	89	85035	151	85185	69	85346	108	85551	73
84434	71	84626	92	84746	87	84877	89	85036	151	85186	69	85349	108	85551	278
84435	71	84627	93	84747	87	84878	89	85038	151	85187	69	85350	108	85553	61
84436	71	84628	93	84748	87	84879	89	85039	151	85188	69	85352	108	85554	61
84438	71	84630	93	84749	87	84880	89	85040	151	85189	136	85353	108	85562	74
84439	71	84632	93	84750	87	84883	89	85041	151	85190	136	85354	108	85563	75
84440	71	84633	93	84751	87	84884	89	85042	151	85191	69	85355	108	85564	75
84446	71	84634	93	84752	87	84885	89	85045	151	85192	69	85356	109	85565	75
84457	71	84635	103	84755	87	84886	89	85046	151	85197	100	85357	109	85566	76
84458	71	84636	103	84756	87	84887	89	85049	151	85198	100	85358	109	85567	76
84459	71	84641	94	84757	87	84888	89	85050	151	85199	100	85359	109	85572	132
84461	71	84642	94	84758	87	84889	89	85051	151	85200	100	85360	109	85573	132
84462	71	84643	94	84761	87	84897	89	85052	151	85206	100	85361	109	85580	132
84463	72	84644	94	84762	87	84903	90	85053	152	85209	100	85362	109	85581	132
84464	72	84647	94	84767	87	84904	90	85054	152	85210	100	85363	109	85582	132
84466	72	84648	94	84768	87	84905	90	85055	152	85211	133	85368	109	85583	132
84467	72	84651	95	84769	87	84906	90	85056	152	85212	133	85369	109	85584	132
84468	72	84652	95	84770	87	84907	90	85057	152	85219	100	85370	109	85592	132
84469	72	84653	95	84771	87	84908	90	85058	152	85220	100	85371	109	85593	132
84471	72	84654	95	84774	144	84917	90	85066	152	85221	100	85375	109	85598	132
84472	72	84661	92	84775	144	84918	90	85069	153	85222	100	85377	109	85599	132
84473	72	84662	92	84776	144	84924	90	85070	153	85225	101	85378	109	85601	95
84476	72	84663	92	84777	144	84925	90	85071	153	85228	101	85382	64	85604	132
84477	72	84664	92	84778	144	84926	90	85072	154	85231	101	85383	64	85605	132
84478	72	84665	92	84779	144	84927	90	85074	154	85236	101	85384	64	85606	132
84483	73	84666	92	84780	144	84928	90	85075	154	85237	101	85385	64	85607	132
84484	73	84667	92	84782	144	84929	88	85076	154	85239	101	85386	64	85610	132
84487	73	84668	92	84783	144	84933	88	85079	143	85240	101	85406	278	85614	132
84488	73	84669	92	84784	145	84934	88	85080	143	85241	101	85407	65	85620	132
84491	73	84670	93	84785	145	84937	90	85083	121	85242	101	85408	65	85629	132
84492	73	84671	93	84788	145	84938	90	85084	121	85243	101	85409	65	85631	132
84493	74	84672	93	84789	145	84941	90	85085	122	85244	101	85410	65	85632	132
84494	74	84673	93	84790	145	84942	90	85086	122	85248	102	85411	65	85633	133
84497	74	84674	93	84791	145	84943	90	85087	122	85249	102	85412	65	85634	133
84498	74	84675	93	84792	146	84944	90	85088	122	85253	102	85414	65	85639	100
84507	76	84676	93	84793	146	84945	90	85091	122	85254	102	85417	65	85642	133
84508	76	84677	93	84794	146	84946	90	85092	122	85255	103	85418	65	85643	133
84511	77	84678	93	84795	146	84949	90	85093	122	85256	103	85427	176	85644	133
84516	82	84679	93	84796	146	84956	90	85094	122	85257	103	85428	176	85645	133
84529	144	84680	93	84797	146	84957	90	85095	123	85258	104	85437	66	85648	133
84530	144	84681	102	84798	147	84958	90	85096	123	85259	104	85438	66	85649	133
84531	144	84682	102	84799	147	84959	90	85097	123	85261	104	85439	66	85650	133
84532	144	84683	102	84800	148	84960	90	8509							

# Part Number Index

BradyID.com/s34

Catalog #	Pg	Catalog #	Pg	Catalog #	Pg	Catalog #	Pg	Catalog #	Pg	Catalog #	Pg	Catalog #	Pg	Catalog #	Pg	Catalog #	Pg	Catalog #	Pg
85897	122	86266	224	86472	231	86573	238	86669	233	86762	235	86903	224	87180	243	87357	243		
85898	122	86267	225	86474	231	86574	238	86670	233	86763	235	86905	224	87181	243	87358	243		
85900	123	86270	225	86475	231	86577	231	86671	233	86764	235	86909	224	87182	243	87359	243		
85901	123	86271	222	86476	231	86578	230	86672	233	86765	235	86913	222	87183	243	87360	243		
85902	123	86275	225	86478	231	86579	231	86673	233	86766	235	87026	209	87184	243	87361	243		
85903	123	86302	224	86481	230	86580	231	86674	233	86767	235	87028	209	87185	243	87362	243		
85904	123	86328	255	86482	230	86581	231	86675	233	86768	235	87031	209	87186	243	87363	243		
85905	123	86329	255	86483	231	86582	231	86676	233	86769	235	87100	243	87187	243	87364	243		
85911	118	86330	255	86484	231	86583	231	86678	233	86770	235	87101	243	87188	243	87365	243		
85912	118	86331	255	86485	230	86584	231	86679	233	86771	235	87102	243	87189	243	87366	243		
85913	118	86332	255	86486	230	86585	231	86680	233	86772	235	87103	243	87190	243	87367	243		
85919	124	86333	255	86487	230	86587	231	86681	233	86773	235	87104	243	87191	243	87368	243		
85920	124	86334	255	86490	231	86588	231	86682	238	86774	235	87105	243	87192	243	87369	243		
85921	124	86336	191	86492	230	86589	231	86683	238	86775	235	87106	243	87193	243	87370	243		
85923	124	86337	192	86493	231	86590	231	86684	238	86776	235	87107	243	87194	243	87371	243		
85924	124	86338	192	86494	230	86591	231	86687	231	86777	235	87108	243	87195	243	87372	243		
85925	124	86339	191	86496	231	86592	231	86688	230	86778	235	87109	243	87196	243	87373	243		
85926	124	86340	278	86497	233	86594	230	86689	231	86779	235	87110	243	87197	243	87374	243		
85927	124	86341	278	86498	233	86595	230	86690	231	86780	235	87111	243	87198	243	87375	243		
85928	124	86342	278	86499	233	86596	231	86691	231	86781	235	87112	243	87199	243	87376	243		
85942	124	86343	278	86500	233	86597	231	86692	231	86783	222	87113	243	87200	243	87377	243		
85949	124	86344	278	86501	233	86598	230	86693	231	86784	222	87114	243	87201	243	87378	243		
85959	124	86345	191	86502	238	86599	230	86694	231	86785	222	87115	243	87202	243	87379	243		
85960	124	86403	231	86503	233	86600	230	86695	231	86786	222	87116	243	87203	243	87380	243		
85971	125	86404	230	86504	233	86601	230	86697	231	86789	222	87117	243	87204	243	87381	243		
85972	125	86405	231	86505	233	86602	230	86698	231	86792	223	87118	243	87205	243	87382	243		
85973	125	86406	231	86506	233	86603	231	86699	231	86793	223	87119	243	87206	243	87383	243		
85974	125	86407	231	86508	233	86604	230	86700	231	86796	223	87120	243	87207	243	87384	243		
85975	125	86408	231	86509	233	86605	230	86701	231	86797	223	87121	243	87208	243	87385	243		
85979	125	86409	231	86510	233	86606	231	86702	231	86798	223	87122	243	87209	243	87386	243		
85985	125	86410	231	86511	233	86607	230	86704	230	86799	223	87123	243	87300	243	87387	243		
85986	125	86411	231	86512	233	86608	230	86705	230	86801	223	87124	243	87301	179	87388	243		
85987	125	86413	231	86513	233	86609	231	86706	231	86804	223	87125	243	87302	243	87389	243		
85988	125	86414	231	86514	234	86610	233	86707	231	86808	223	87126	243	87303	243	87390	243		
85989	125	86415	231	86515	234	86611	233	86708	231	86811	223	87127	243	87304	243	87391	243		
85990	125	86416	231	86516	234	86612	233	86709	230	86813	223	87128	243	87305	243	87392	243		
85995	125	86417	231	86517	234	86613	233	86710	230	86817	223	87129	243	87306	243	87393	243		
85997	125	86418	231	86518	234	86614	233	86711	230	86818	223	87130	243	87307	243	87394	243		
85998	125	86420	230	86519	236	86615	233	86712	230	86826	224	87131	243	87308	243	87395	243		
86007	158	86421	230	86522	231	86616	233	86713	231	86828	224	87132	243	87309	243	87396	243		
86008	158	86422	231	86523	230	86617	233	86714	230	86830	224	87133	243	87310	243	87397	243		
86009	158	86423	231	86524	231	86618	233	86715	230	86832	224	87134	243	87311	243	87398	243		
86010	158	86424	230	86525	231	86619	233	86716	231	86837	224	87135	243	87312	243	87399	243		
86011	158	86425	230	86526	231	86620	233	86717	230	86838	224	87136	243	87313	243	87400	243		
86012	158	86426	230	86527	231	86621	233	86718	231	86839	224	87137	243	87314	243	87401	243		
86013	158	86427	230	86528	231	86623	233	86719	231	86841	222	87138	243	87315	243	87402	243		
86014	158	86428	230	86529	231	86624	233	86720	233	86842	222	87139	243	87316	243	87403	243		
86015	158	86429	231	86530	231	86625	233	86721	233	86843	222	87140	243	87317	243	87404	243		
86016	158	86430	230	86532	231	86626	233	86722	233	86844	222	87141	243	87318	243	87405	243		
86018	158	86431	230	86533	231	86627	238	86723	233	86846	222	87142	243	87319	243	87406	243		
86023	158	86432	231	86534	231	86628	238	86724	233	86847	222	87143	243	87320	243	87407	243		
86024	158	86433	230	86535	231	86629	238	86725	233	86850	222	87144	243	87321	243	87408	243		
86025	158	86434	231	86536	231	86632	231	86726	233	86853	222	87145	243	87322	243	87409	243		
86027	158	86435	233	86537	231	86633	230	86727	233	86857	222	87146	243	87323	243	87460	243		
86029	158	86436	233	86539	230	86634	231	86728	233	86859	224	87147	243	87324	243	87461	243		
86033	100	86437	233	86540	230	86635	231	86729	233	86860	223	87148	243	87325	243	87462	243		
86034	100	86438	233	86541	231	86636	231	86730	233	86861	223	87149	243	87326	243	87463	243		
86090	102	86439	233	86542	231	86637	231	86731	233	86862	223	87150	243	87327	243	87464	243		
86091	104	86441	233	86543	230	86638	231	86733	233	86863	223	87151	243	87328	243	87465	243		
86092	103	86442	233	86544	230	86639	231	86734	233	86864	222	87152	243	87329	243	87466	243		
86148	223	86443	233	86545	230	86640	231	86735	233	86865	224	87153	243	87330	243	87467	243		
86193	224	86444	233	86546	230	86642	231	86736	233	86866	222	87154	243	87331	243	87468	243		
86194	224	86445	233	86547	230	86643	231	86737	238	86867	223	87155	243	87332	243	87469	243		
86198	225	86446	233	86548	231	86644	231	86738	238	86868	223	87156	243	87333	243	87470	243		
86199	225	86447	233	86549	230	86645	231	86739	238	86869	223	87157	243	87334	243	87471	243		
86203	225	86448	233	86550	230	86646	231	86740	235	86870	222	87158	243	87335	243	87472	243		
86204	225	86449	233	86551	231	86647	231	86741	235	86871	223	87159	243	87336	243	87473	243		
86204	493	86450	233	86552	230	86649	230	86742	235	86874	223	87160	243	87337	243	87474	243		
86213	225	86451	233	86553	231	86650	230	86743	235	86877	223	87161	243	87338	243	87475	243		
86216	225	864																	

# Part Number Index

BradyID.com/s34

Catalog #	Pg	Catalog #	Pg	Catalog #	Pg	Catalog #	Pg	Catalog #	Pg	Catalog #	Pg	Catalog #	Pg	Catalog #	Pg
87494	243	87694	400	88101	125	88281	130	88436	139	88643	150	88870	165	89171	156
87495	243	87695	244	88102	125	88283	130	88437	139	88644	150	88871	165	89172	89
87496	243	87696	244	88107	125	88285	130	88438	139	88645	150	88872	165	89173	30
87497	243	87696	244	88108	125	88288	130	88439	139	88646	150	88873	165	89176	138
87498	243	87696	400	88109	125	88298	130	88440	139	88647	150	88874	165	89256	482
87499	243	87697	244	88115	125	88299	130	88441	139	88648	150	88875	165	89257	208
87500	243	87697	400	88116	125	88302	119	88442	139	88649	151	88876	165	90018	172
87501	243	87698	244	88117	125	88303	119	88443	138	88651	151	88877	165	90019	270
87502	243	87698	400	88119	125	88304	119	88444	138	88652	151	88878	166	90020	270
87503	243	87699	244	88120	125	88305	131	88445	139	88656	151	88879	166	90100	102
87504	243	87699	400	88123	125	88307	131	88446	139	88659	151	88880	166	90101	102
87505	243	87710	244	88124	125	88310	131	88447	139	88660	151	88881	166	90102	92
87506	243	87710	400	88127	126	88311	131	88448	139	88661	152	88898	166	90103	101
87507	243	87711	244	88128	126	88312	131	88449	137	88662	152	88899	166	90105	94
87508	243	87711	400	88131	126	88314	131	88450	137	88663	152	88905	166	90106	105
87509	243	87712	244	88132	126	88315	131	88451	140	88664	152	88908	166	90107	105
87510	243	87712	400	88135	126	88316	119	88452	140	88669	152	88909	166	90109	92
87511	243	87713	244	88137	126	88317	131	88453	140	88670	152	88910	166	90112	154
87512	243	87713	400	88138	126	88318	131	88454	140	88677	153	88911	166	90121	152
87513	243	87715	133	88141	126	88320	119	88455	72	88678	153	88914	62	90123	91
87514	243	87716	133	88142	126	88323	131	88456	72	88682	142	88915	62	90128	154
87515	243	87717	133	88143	126	88324	131	88457	140	88683	142	88918	62	90139	152
87516	243	87718	159	88144	126	88325	131	88458	140	88684	142	88919	62	90143	54
87517	243	87719	159	88146	126	88326	131	88467	140	88691	155	88922	62	90147	52
87518	243	87732	142	88152	126	88327	131	88468	140	88699	155	88924	62	90149	56
87519	243	87736	133	88153	126	88328	131	88469	140	88700	155	88925	62	90155	60
87600	244	87738	142	88155	126	88329	131	88470	140	88702	155	88926	62	90156	59
87601	244	87740	255	88158	126	88330	131	88471	141	88707	155	88927	62	90157	60
87602	244	87742	255	88160	127	88345	136	88472	141	88708	155	88928	62	90158	59
87603	244	87745	255	88161	127	88346	136	88475	142	88709	155	88930	62	90159	59
87604	244	87746	255	88162	127	88347	136	88476	142	88710	155	88932	62	90160	59
87605	244	87748	70	88163	127	88348	136	88477	142	88715	155	88933	62	90175	42
87606	244	87750	29	88164	127	88351	136	88478	142	88717	155	88935	62	90183	94
87607	244	87751	30	88165	127	88352	136	88479	142	88718	155	88936	157	90184	95
87608	244	87754	30	88172	127	88359	69	88480	142	88725	155	88937	157	90185	106
87609	244	87755	30	88173	127	88360	69	88485	142	88726	155	88938	157	90186	106
87610	244	87757	33	88174	127	88363	136	88486	142	88731	156	88939	62	90187	105
87611	244	87758	33	88175	127	88364	136	88491	74	88733	156	88941	62	90188	60
87612	244	87759	30	88176	127	88369	136	88494	130	88734	156	88942	62	90196	153
87613	244	87762	69	88182	127	88370	136	88495	152	88736	156	88944	62	90199	154
87614	244	87763	68	88183	127	88371	136	88497	90	88737	156	88945	62	90307	255
87615	244	87764	68	88184	127	88374	136	88498	90	88738	156	88946	62	90331	255
87616	244	87767	73	88185	127	88375	136	88500	75	88739	156	88947	62	90333	255
87617	244	87768	84	88186	127	88376	137	88502	108	88740	156	88948	62	90366	102
87618	244	87769	144	88187	128	88377	137	88503	131	88741	156	88949	62	90367	104
87619	244	87770	145	88188	128	88378	137	88504	103	88742	156	89001	62	90368	106
87620	244	87771	145	88189	128	88379	137	88505	104	88743	156	89006	62	90369	104
87627	244	87772	145	88191	128	88380	137	88506	75	88745	156	89015	77	90370	105
87628	244	87773	70	88192	128	88381	137	88509	172	88746	156	89017	238	90371	103
87629	244	87774	86	88193	128	88382	137	88511	153	88747	156	89018	238	90372	101
87630	244	87775	86	88194	128	88383	137	88512	90	88748	156	89087	64	90373	104
87631	244	87776	86	88199	128	88384	137	88513	131	88749	156	89088	64	90376	102
87632	244	87777	150	88205	128	88386	137	88516	159	88750	156	89090	145	90377	102
87633	244	87778	145	88206	128	88387	137	88517	34	88751	156	89091	145	90379	101
87634	244	87779	151	88208	128	88388	137	88520	138	88752	156	89093	119	90379	101
87635	244	87780	149	88209	128	88389	137	88521	131	88762	157	89097	77	90380	105
87636	244	87781	151	88215	128	88392	137	88522	77	88767	157	89098	89	90383	103
87637	244	87782	123	88216	128	88393	137	88525	154	88768	157	89099	89	90384	105
87638	244	87783	122	88217	129	88394	137	88527	154	88769	157	89100	90	90386	106
87639	244	87784	122	88218	129	88396	138	88528	109	88770	157	89104	100	90400	249
87640	244	87785	108	88221	129	88397	138	88529	77	88791	165	89105	100	90401	249
87641	244	87786	108	88225	129	88400	138	88530	159	88792	165	89106	100	90402	249
87642	244	87788	125	88226	129	88401	138	88543	143	88810	165	89107	100	90403	249
87643	244	87790	121	88231	129	88402	138	88544	143	88811	165	89110	100	90404	249
87647	71	87791	120	88234	129	88403	138	88545	144	88814	165	89112	156	90405	249
87648	71	87792	127	88237	129	88404	138	88546	144	88815	165	89113	62	90406	249
87651	95	87793	126	88238	129	88405	138	88547	144	88816	165	89115	62	90407	249
87662	108	87795	138	88243	129	88410	138	88548	144	88817	165	89128	159	90408	249
87664	145	87796	137	88244	129	88411	138	88551	144	88830	165	89129	177	90409	249
87667	90	87797	137	88245	129	88412	138	88552	144	88831	165	89131	179	90410	249
87669	127	87807B	97	88246	129	88413	138	88557	146	88834	165	89132	179	90411	249
87670	127	87808B	97	88247	129	88414	138	88572	146	88835	165	89133	177	90412	249
87674	83	87942	243	88248	129	88418	138	88583	147	88838	165	89134	177	90413	249
87675	83	87982	191	88251	129	88421	138	88584	147	88839	165	89135	182	90414	249
87677	138	88051	273	88252	129	88422	138	88585	147	88840	165	89136	181	90415	249
87678	89	88052	62	88253	129	88423	138	88586	147	88842	165	89149	104	90416	249
87681	89	88053	62	88254	129	88424	138	88609	149	88843	165	89152	90	90417	249
87682	165	88054	62	88255	129	88425	138	88610	149	88844	165	89153	90	90418	249
87684	141	88056	62	88256	129	88426	138	88611	148	88846	165	89154	138	90419	249
87685	141	88057	62	88257	129	88427	138	88612	148	88849	165	89155	177	90420	249
87687	141	88058	62	88258	129	88428	138	88617	149	88849	165	89156	177	90421	249
87688	141	88059	62	88259	129	88429	138	88618	149	88852	165	89156	92	90422	249
87689	141														

# Part Number Index

BradyID.com/s34

Catalog #	Pg	Catalog #	Pg	Catalog #	Pg	Catalog #	Pg	Catalog #	Pg	Catalog #	Pg	Catalog #	Pg	Catalog #	Pg
90587	154	90795	53	91020	103	91413	259	91943	255	93621	157	95041	179	95228	227
90607	109	90797	52	91031	104	91414	259	91944	255	93625	157	95042	187	95229	229
90611	94	90799	51	91082	274	91415	259	91948	255	93627	157	95043	185	95230	31
90616	92	90803	52	91083	274	91416	259	91949	255	93629	157	95044	185	95233	32
90617	101	90804	59	91084	274	91417	259	91950	255	93631	157	95045	185	95236	32
90619	94	90805	60	91085	274	91418	259	91951	255	93634	157	95046	185	95237	32
90620	105	90807	56	91086	274	91419	259	91953	255	93636	157	95047	190	95238	32
90622	92	90808	57	91087	274	91420	259	91955	255	93637	157	95071	282	95240	31
90623	92	90809	50	91088	275	91421	259	91956	255	93638	157	95072	282	95241	32
90625	102	90810	55	91089	275	91422	259	91958	255	93640	157	95073	282	95242	32
90626	102	90811	57	91090	275	91423	259	91959	255	94008	114	95074	282	95243	32
90627	102	90816	50	91091	275	91424	259	91961	255	94014	114	95075	282	95245	32
90628	92	90817	51	91092	275	91425	259	91964	255	94022	113	95090	282	95246	32
90629	101	90818	51	91100	274	91426	259	91965	255	94027	113	95091	282	95247	32
90630	102	90819	54	91101	274	91427	259	91966	255	94029	114	95092	282	95248	32
90631	94	90820	52	91102	274	91428	259	91967	255	94044	114	95093	282	95254	31
90632	105	90821	58	91103	274	91429	259	91968	255	94054	114	95094	282	95255	31
90633	60	90822	59	91104	274	91430	259	91972	255	94105	181	95097	282	95256	31
90634	92	90839B	97	91165	260	91431	259	91974	255	94106	186	95098	282	95258	31
90635	92	90840B	97	91165	401	91432	259	91977	255	94112	172	95099	282	95259	31
90636	102	90841B	97	91166	260	91433	259	91978	255	94116	181	95100	282	95262	32
90637	102	90842B	97	91166	401	91447	274	91979	255	94117	181	95101	282	95263	32
90643	154	90844	484	91172	274	91448	274	91981	255	94119	181	95102	282	95265	32
90644	153	90845	484	91173	274	91450	274	91997	255	94120	181	95103	282	95266	32
90645	153	90847	484	91175	274	91451	274	91998	255	94123	186	95137	487	95268	31
90646	154	90848	484	91176	274	91452	274	92010	276	94124	181	95138	487	95269	136
90649	152	90850	484	91179	274	91453	274	92011	276	94127	181	95139	487	95270	31
90650	152	90851	484	91200	274	91454	274	92012	276	94130	182	95140	282	95272	86
90654	54	90853	484	91201	274	91455	274	92116	276	94142	185	95141	282	95275	31
90655	52	90854	484	91212	274	91456	274	92117	276	94143	185	95142	93	95277	72
90656	54	90885B	97	91213	274	91457	274	92118	276	94144	185	95143	282	95278	31
90657	55	90886B	97	91214	274	91458	274	92119	276	94145	185	95144	282	95279	32
90658	52	90887B	97	91215	274	91462	274	92120	276	94148	187	95146	104	95280	32
90662	59	90888B	97	91217	274	91463	274	92121	276	94150	179	95147	102	95281	32
90666	55	90891	483	91220	274	91464	274	92122	276	94152	187	95150	282	95283	32
90667	57	90892	483	91227	274	91469	274	92123	276	94163	177	95154	137	95284	31
90668	57	90893	483	91224	274	91468	274	92125	276	94174	172	95155	282	95285	32
90670	59	90895	105	91237	274	91470	274	92126	276	94175	173	95158	282	95287	89
90674	56	90910	260	91238	274	91600	275	92127	276	94180	180	95159	282	95288	32
90680	56	90912	190	91255	274	91601	275	92134	276	94181	180	95160	282	95289	32
90685	60	90913	190	91256	274	91603	275	92135	276	94183	180	95161	282	95290	32
90686	60	90923	92	91257	274	91604	275	92136	276	94185	180	95162	282	95291	32
90687	59	90924	92	91287	259	91606	275	92137	276	94190	181	95163	282	95293	32
90690	59	90926	91	91288	259	91883	255	92280	277	94192	182	95164	282	95294	32
90691	59	90927	92	91289	259	91884	255	92281	277	94195	183	95165	282	95296	32
90692	49	90928	94	91290	259	91885	255	92282	277	94197	183	95166	282	95297	32
90704	61	90929	94	91294	275	91886	255	92283	277	94199	183	95167	282	95298	32
90706	49	90930	105	91295	275	91887	255	92284	277	94209	185	95168	282	95300	32
90707	49	90931	95	91296	275	91888	255	92285	277	94210	185	95169	282	95301	32
90710	75	90933	92	91297	275	91889	255	92286	277	94211	185	95170	282	95305	32
90713	95	90934	92	91298	275	91890	255	92288	277	94212	185	95171	282	95309	32
90714	94	90935	109	91299	275	91891	255	92289	277	94213	185	95172	282	95310	32
90717	106	90936	94	91319	159	91892	255	92289	493	94218	186	95173	282	95311	32
90718	105	90937	102	91324	172	91893	255	92400	110	94222	178	95174	282	95312	32
90719	105	90939	94	91326	172	91894	255	92404	110	94225	179	95175	282	95314	32
90720	152	90940	92	91331	172	91895	255	92405	110	94234	179	95193	282	95315	32
90721	154	90941	93	91332	172	91896	255	92406	110	94235	179	95195	282	95316	32
90722	154	90942	102	91333	172	91897	255	92407	110	94237	183	95196	282	95317	32
90723	153	90943	102	91334	172	91898	255	92408	110	94240	185	95197	282	95318	32
90725	154	90944	92	91336	173	91899	255	92414	272	94307	178	95198	282	95321	31
90726	153	90946	102	91351	172	91900	255	92415	272	94336	172	95199	283	95324	32
90727	153	90947	94	91352	172	91901	255	92416	272	94917	277	95200	283	95326	28
90729	154	90948	105	91354	172	91906	255	92417	272	94996	69	95201	283	95327	28
90731	152	90949	60	91356	173	91907	255	93242	259	94998	69	95202	283	95328	28
90732	152	90950	92	91357	172	91909	255	93243	259	94999	69	95203	283	95329	28
90734	55	90951	92	91358	172	91910	255	93247	259	95000	69	95204	283	95330	28
90736	54	90952	102	91359	172	91911	255	93248	259	95001	69	95205	283	95331	28
90737	52	90953	102	91360	172	91913	255	93252	259	95002	69	95206	283	95332	28
90740	52	90960	153	91362	173	91914	255	93257	259	95003	69	95207	283	95333	28
90743	52	90964	91	91363	173	91915	255	93258	259	95005	75	95208	283	95335	28
90744	50	90966	94	91370	172	91916	255	93262	259	95006	75	95209	283	95338	28
90748	60	90967	103	91371	172	91917	255	93267	259	95007	75	95210	283	95339	28
90749	59	90968	101	91372	172	91918	255	93272	259	95008	75	95211	31	95340	28
90750	60	90969	104	91375	173	91920	255	93275	271	95009	75	95212	31	95341	28
90751	59	90971	273	91376	172	91921	255	93390	259	95010	75	95213	31	95343	28
90752	59	90972	273	91377	172	91925	255	93391	259	95011	75	95214	31	95344	28
90753	59	90973	273	91378	172	91926	255	93392	259	95012	82	95216	31	95345	28
90769	49	90974	273	91384	173	91930	255	93394	259	95013	82	95218	227	95346	28
90775	95	90975	104	91386	173	91933	255	93395	259	95014	82	95219	227	95347	28
90776	94	90976	102	91387	173	91934	255	93396	259	95015	82	95220	227	95348	28
90777	95	90977	105	91388	173	91935	255	93397	259	95018	82	95221	227	95349	28
90780	105	90988	105	91389	173	91936	255	93600	156	95027	169	95222	227	95351	85
90781	105	90992	106	91408	259	91937</									

# Part Number Index

BradyID.com/s34

Catalog #	Pg	Catalog #	Pg	Catalog #	Pg	Catalog #	Pg	Catalog #	Pg	Catalog #	Pg	Catalog #	Pg	Catalog #	Pg
95471.....	167	96087.....	75	96290.....	283	99048.....	272	99696.....	454	102055.....	236	102144.....	236	104319.....	265
95472.....	167	96089.....	388	96291.....	283	99049.....	272	99697.....	454	102056.....	236	102145.....	236	104340.....	265
95473.....	167	96089.....	389	96292.....	283	99050.....	272	99699.....	454	102057.....	236	102146.....	236	104341.....	265
95474.....	167	96090.....	75	96293.....	283	99052.....	272	99700.....	454	102058.....	236	102147.....	236	104342.....	265
95475.....	167	96155.....	221	96294.....	283	99053.....	272	99703.....	454	102059.....	236	102148.....	236	104343.....	265
95476.....	167	96156.....	221	96295.....	283	99054.....	272	99704.....	454	102060.....	236	102149.....	236	104344.....	265
95477.....	167	96157.....	221	96296.....	283	99055.....	272	99706.....	454	102061.....	236	102150.....	236	104345.....	265
95478.....	167	96158.....	221	96297.....	283	99162.....	451	99707.....	454	102062.....	236	102151.....	236	104346.....	265
95479.....	167	96159.....	221	96907.....	113	99167.....	395	99709.....	452	102063.....	236	102152.....	236	104347.....	265
95481.....	167	96160.....	221	96908.....	114	99168.....	395	99710.....	452	102064.....	236	102153.....	236	104348.....	265
95483.....	167	96162.....	221	96920.....	278	99169.....	395	101416.....	446	102066.....	236	102154.....	236	104349.....	265
95484.....	167	96163.....	221	96921.....	278	99170.....	395	101956.....	466	102067.....	236	102155.....	236	104370.....	265
95485.....	167	96164.....	221	96922.....	278	99175.....	208	101957.....	468	102068.....	236	102157.....	236	104371.....	265
95486.....	167	96165.....	221	96923.....	278	99195.....	208	101958.....	468	102069.....	236	102158.....	236	104372.....	265
95487.....	167	96167.....	221	96950.....	278	99199.....	208	101963.....	469	102070.....	236	102159.....	236	104373.....	265
95488.....	167	96168.....	221	96951.....	278	99219.....	387	101972.....	193	102071.....	236	102160.....	236	104374.....	265
95489.....	168	96170.....	221	96952.....	278	99220.....	387	101973.....	234	102072.....	236	102161.....	236	104375.....	265
95491.....	168	96171.....	221	96953.....	278	99221.....	387	101974.....	234	102073.....	236	102162.....	236	104376.....	265
95492.....	168	96173.....	221	96954.....	278	99287.....	219	101975.....	234	102074.....	236	102163.....	236	104377.....	265
95493.....	168	96175.....	221	96955.....	278	99289.....	213	101976.....	234	102075.....	236	102164.....	236	104378.....	265
95494.....	168	96177.....	221	97084.....	278	99289.....	492	101977.....	234	102076.....	236	102165.....	236	104379.....	265
95495.....	168	96178.....	221	97198.....	214	99290.....	442	101978.....	234	102077.....	236	102166.....	236	104400.....	266
95496.....	168	96179.....	221	97198.....	216	99292.....	442	101979.....	234	102078.....	236	102167.....	236	104401.....	266
95498.....	135	96180.....	221	97199.....	214	99293.....	442	101980.....	234	102079.....	236	102523.....	219	104402.....	266
95499.....	135	96222.....	234	97199.....	216	99296.....	442	101981.....	234	102080.....	236	102524.....	219	104403.....	266
95500.....	135	96222.....	462	97200.....	190	99297.....	442	101982.....	234	102081.....	236	102525.....	219	104404.....	266
95501.....	135	96229.....	422	97204.....	190	99300.....	442	101983.....	234	102082.....	236	102692.....	446	104405.....	266
95502.....	135	96230.....	283	97205.....	190	99302.....	442	101984.....	234	102083.....	236	102693.....	446	104406.....	266
95503.....	135	96231.....	283	97206.....	190	99303.....	442	101991.....	234	102084.....	236	102696.....	468	104407.....	266
95504.....	101	96232.....	283	97207.....	190	99305.....	445	101992.....	234	102085.....	236	102698.....	468	104408.....	266
95505.....	101	96233.....	283	97208.....	190	99307.....	445	101993.....	234	102086.....	236	102821.....	274	104409.....	266
95538.....	442	96234.....	283	97209.....	190	99308.....	445	101994.....	234	102087.....	236	102822.....	274	104410.....	266
95540.....	445	96235.....	283	97210.....	190	99310.....	445	101995.....	234	102088.....	236	102823.....	274	104411.....	266
95548.....	442	96236.....	283	97211.....	190	99312.....	445	101996.....	234	102089.....	236	102824.....	274	104412.....	266
95550.....	442	96237.....	283	97554.....	216	99313.....	445	101997.....	234	102090.....	236	102824.....	274	104413.....	266
95553.....	442	96238.....	283	97555.....	216	99320.....	447	101998.....	234	102091.....	236	102825.....	251	104414.....	266
95559.....	62	96239.....	283	97556.....	216	99321.....	447	101999.....	234	102092.....	236	102825.....	270	104415.....	266
95563.....	62	96240.....	283	97557.....	216	99324.....	447	102000.....	234	102093.....	236	102826.....	270	104416.....	266
95635.....	282	96241.....	283	97609.....	110	99326.....	108	102001.....	234	102094.....	236	102826.....	270	104417.....	266
95636.....	282	96242.....	283	97610.....	110	99500.....	468	102002.....	234	102095.....	236	102827.....	270	104418.....	266
95643.....	282	96243.....	283	97611.....	110	99504.....	468	102003.....	234	102096.....	236	102827.....	270	104419.....	266
95644.....	282	96244.....	283	97613.....	110	99508.....	468	102004.....	234	102097.....	236	102828.....	252	104420.....	266
95645.....	282	96245.....	283	97614.....	110	99512.....	468	102005.....	234	102098.....	236	102828.....	270	104421.....	266
95646.....	282	96246.....	283	97615.....	110	99516.....	468	102006.....	234	102099.....	236	102829.....	270	104422.....	266
95647.....	282	96247.....	283	97616.....	110	99520.....	468	102007.....	234	102100.....	236	102830.....	270	104423.....	266
95648.....	282	96248.....	283	97738.....	383	99524.....	468	102008.....	234	102101.....	236	102831.....	270	104424.....	266
95649.....	282	96249.....	283	97739.....	383	99528.....	468	102009.....	234	102102.....	236	102832.....	270	104425.....	266
95650.....	282	96250.....	283	97740.....	383	99533.....	468	102010.....	234	102103.....	236	102833.....	270	104426.....	266
95651.....	282	96251.....	283	97741.....	383	99539.....	468	102011.....	234	102104.....	236	102833.....	270	104427.....	266
95652.....	282	96252.....	283	97742.....	383	99543.....	468	102012.....	234	102105.....	236	102835.....	270	104428.....	266
95653.....	282	96253.....	283	97743.....	383	99548.....	468	102013.....	234	102106.....	236	102836.....	270	104429.....	266
95654.....	282	96254.....	283	97744.....	383	99552.....	466	102014.....	234	102107.....	236	102837.....	270	104430.....	266
95655.....	282	96255.....	283	97745.....	383	99556.....	466	102015.....	234	102108.....	236	102838.....	270	104431.....	266
95656.....	282	96256.....	283	98165.....	275	99564.....	466	102016.....	234	102109.....	236	102839.....	270	104432.....	266
95657.....	282	96257.....	283	98166.....	275	99570.....	466	102017.....	234	102110.....	236	102840.....	270	104433.....	266
95658.....	282	96258.....	283	98167.....	275	99576.....	466	102018.....	234	102111.....	236	102849.....	97	104434.....	266
95659.....	282	96259.....	283	98168.....	275	99580.....	466	102019.....	234	102113.....	236	102851.....	97	104435.....	266
95660.....	282	96260.....	283	98169.....	275	99608.....	469	102020.....	234	102114.....	236	102852.....	97	104436.....	266
95661.....	282	96261.....	283	98170.....	275	99609.....	469	102021.....	234	102115.....	236	102853.....	97	104437.....	266
95662.....	282	96262.....	283	98171.....	275	99610.....	469	102024.....	228	102116.....	236	102857.....	97	104438.....	266
95663.....	282	96263.....	283	98172.....	275	99611.....	469	102025.....	228	102117.....	236	103025.....	351	104439.....	266
95664.....	282	96264.....	283	98173.....	275	99612.....	469	102026.....	228	102118.....	236	103026.....	351	104440.....	266
95665.....	282	96265.....	283	98174.....	275	99613.....	469	102027.....	228	102119.....	236	103027.....	351	104441.....	266
95666.....	282	96266.....	283	98175.....	275	99615.....	469	102030.....	228	102120.....	236	103028.....	351	104442.....	266
95667.....	282	96267.....	283	98176.....	275	99616.....	469	102032.....	236	102121.....	236	103029.....	351	104443.....	266
95668.....	282	96268.....	283	98177.....	275	99617.....	469	102033.....	236	102122.....	236	103030.....	351	104444.....	266
95669.....	282	96269.....	283	98178.....	275	99618.....	469	102034.....	236	102123.....	236	103031.....	351	104445.....	266
95670.....	282	96270.....	283	98219.....	462	99619.....	469	102035.....	236	102124.....	236	103033.....	466	104446.....	266
95671.....	282	96271.....	283	98455.....	272	99620.....	469	102036.....	236	102125.....	236	103566.....	191	104447.....	266
95672.....	282	96272.....	283	98457.....	272	99668.....	474	102037.....	236	102126.....	236	103567.....	191	104448.....	266
95673.....	282	96273.....	283	98459.....	272	99676.....	446	102038.....	236	102127.....	236	103568.....	191	104449.....	266
95674.....	282	96274.....	283	98499.....	255	99677.....	446	102039.....	236	102128.....	236	103569.....	191	104450.....	266
95675.....	282	96275.....	283	98621.....	255	99678.....	446	102040.....	236	102129.....	236	103570.....	191	104451.....	266
95677.....	282	96276.....	283	98838.....	255	99679.....	446	102041.....	236	102130.....	236	103598.....	102	104452.....	266
95678.....	282	96277.....	283	98844.....	255	99680.....	446	102042.....	236	102131.....	236	103599.....	102	104453.....	266
95679.....	282	96278.....	283	98848.....	245	99681.....	446	102043.....	236	102132.....	236	103644.....	169	104454.....	266
95680.....	282														

# Part Number Index

BradyID.com/s34

Catalog #	Pg	Catalog #	Pg	Catalog #	Pg	Catalog #	Pg	Catalog #	Pg	Catalog #	Pg	Catalog #	Pg	Catalog #	Pg
104571	219	105676	458	105778	252	105957	450	106118	252	106316	160	113148	382	114655	96
104572	469	105677	458	105779	252	105958	450	106119	252	106318	160	113149	382	114656	96
104573	469	105679	458	105780	252	105959	450	106120	252	106321	160	113150	382	114657	96
104574	469	105680	458	105781	252	105960	450	106121	252	106322	160	113151	382	114658	96
104575	469	105681	458	105782	252	105961	450	106122	252	106323	160	113152	382	114659	96
104576	469	105682	458	105783	252	105962	450	106123	252	106324	161	113153	382	114660	96
104577	469	105683	458	105784	252	105963	449	106124	252	106325	161	113154	382	114661	96
104578	469	105684	459	105785	252	105964	449	106125	252	106326	160	113182	349	114662	96
104579	469	105685	459	105786	252	105965	449	106126	252	106327	161	113183	349	114663	96
104791	212	105686	459	105787	252	105966	448	106127	252	106328	161	113184	349	114664	96
104792	212	105687	459	105788	252	105967	448	106128	252	106329	161	113185	349	114665	96
104794	449	105688	459	105789	252	105968	448	106129	252	106330	161	113186	349	114666	96
104795	449	105689	459	105790	252	105969	448	106130	252	106331	161	113187	349	114673	96
104796	449	105690	459	105791	252	105970	448	106131	252	106332	161	113188	349	114674	96
104808	277	105691	459	105792	252	105971	259	106132	252	106333	160	113189	349	114675	96
104809	277	105692	459	105793	252	105972	259	106133	252	106334	160	113190	349	114676	96
104810	277	105693	459	105794	252	105973	259	106134	252	106460	400	113191	349	114677	96
104811	277	105694	459	105795	252	105974	259	106135	252	106460	400	113192	349	114678	96
104916	466	105695	459	105796	252	105975	259	106136	252	106461	402	113193	349	114679	96
104917	468	105696	459	105797	252	105976	259	106137	252	106461	402	113194	349	114680	96
104918	468	105697	459	105798	252	105977	259	106138	252	106462	400	113195	349	114681	96
104919	466	105698	459	105799	252	105978	259	106139	252	106462	402	113196	349	114685	96
104920	468	105699	459	105800	252	105979	259	106140	252	106463	402	113197	349	114686	96
104921	468	105700	459	105801	252	105980	259	106141	252	106464	402	113198	349	114687	96
105038	402	105705	459	105802	252	105981	259	106142	252	106465	402	113199	349	114688	96
105041	402	105706	459	105803	252	105982	259	106143	252	110017	272	113200	349	114689	96
105088	349	105707	459	105804	252	105983	259	106144	252	110018	272	113201	349	114690	96
105089	349	105708	459	105805	252	105984	259	106145	252	110019	272	113202	349	114691	96
105557	259	105709	459	105806	252	105985	259	106146	252	110020	279	113203	349	114692	96
105562	259	105710	459	105807	252	105986	259	106147	252	110220	382	113204	349	114693	96
105563	259	105711	459	105808	252	105987	259	106148	252	110221	389	113205	349	115751	349
105564	259	105712	459	105809	252	105988	259	106149	252	110972	140	113206	349	115752	349
105565	259	105713	459	105810	252	106063	252	106150	252	110973	140	113207	349	115753	349
105567	259	105714	473	105811	252	106064	252	106151	252	110975	140	113208	349	115754	349
105572	259	105715	473	105812	252	106065	252	106152	252	110976	140	113209	349	115755	349
105573	259	105716	472	105813	252	106066	252	106153	252	110977	140	113210	349	115756	349
105574	259	105717	472	105814	252	106067	252	106154	252	110978	140	113211	349	115757	349
105575	259	105718	474	105881	469	106068	252	106155	252	110979	140	113212	349	115758	349
105577	259	105719	474	105882	469	106069	252	106156	252	112500	172	113213	349	115759	349
105577	259	105720	474	105883	469	106070	252	106157	252	112653B	97	113214	349	115760	349
105634	458	105721	474	105884	469	106071	252	106158	252	112654B	97	113215	349	115761	349
105635	458	105722	462	105885	469	106072	252	106159	252	112655B	97	113216	349	115762	349
105636	458	105723	462	105886	466	106073	252	106160	252	112656B	97	113217	349	115763	385
105637	458	105724	462	105887	466	106074	252	106161	252	113063B	97	113218	349	115764	385
105638	458	105729	143	105888	466	106075	252	106162	252	113105	382	113219	349	115765	385
105639	458	105735	252	105889	466	106076	252	106163	252	113106	382	113220	350	115766	385
105640	458	105736	252	105890	466	106077	252	106164	252	113107	382	113221	350	115767	385
105641	458	105737	252	105891	466	106078	252	106165	252	113108	382	113222	350	115768	385
105642	458	105738	252	105892	466	106079	252	106166	252	113109	382	113225	350	115769	385
105643	458	105739	252	105893	466	106080	252	106168	252	113110	382	113226	350	115770	385
105644	459	105740	252	105894	468	106081	252	106169	252	113111	382	113227	350	115771	385
105645	459	105741	252	105895	468	106082	252	106171	252	113112	382	113228	350	115772	385
105646	459	105742	252	105896	468	106083	252	106172	252	113113	382	113229	350	115773	385
105647	459	105743	252	105897	468	106084	252	106174	252	113114	382	113230	350	118815	204
105648	459	105744	252	105898	468	106085	252	106175	252	113115	382	113231	477	118816	204
105649	459	105745	252	105899	468	106086	252	106176	252	113116	382	113232	477	118817	204
105650	459	105746	252	105900	468	106087	252	106177	252	113117	382	113233	477	118821	204
105651	459	105747	252	105901	468	106088	252	106178	252	113118	382	113234	477	118822	204
105652	459	105748	252	105902	469	106089	252	106179	63	113119	382	113238	279	118823	204
105653	459	105749	252	105903	469	106090	252	106180	63	113120	382	113239	279	118827	204
105654	459	105750	252	105904	469	106091	252	106181	63	113121	382	113240	279	118828	204
105655	459	105751	252	105905	451	106092	252	106182	63	113122	382	113241	279	118829	204
105656	459	105752	252	105906	451	106093	252	106183	63	113123	382	113242	279	118833	204
105657	459	105753	252	105909	386	106094	252	106184	63	113124	382	113243	279	118834	204
105658	459	105754	252	105910	386	106095	252	106186	63	113125	382	113244	279	118835	204
105659	459	105755	252	105911	386	106096	252	106291	161	113126	382	114533	388	118839	204
105660	459	105756	252	105912	395	106097	252	106292	161	113127	382	114634	273	118840	204
105661	459	105757	252	105913	395	106098	252	106293	161	113128	382	114635	273	118841	204
105662	459	105758	252	105914	395	106099	252	106294	161	113129	382	114636	273	118845	204
105663	459	105759	252	105928	453	106100	252	106295	161	113130	382	114637	96	118846	204
105664	459	105760	252	105929	453	106101	252	106296	161	113131	382	114638	96	118847	204
105665	459	105761	252	105930	453	106102	252	106297	161	113132	382	114639	96	118851	204
105666	459	105763	252	105931	453	106103	252	106298	161	113133	382	114640	96	118852	204
105667	459	105764	252	105932	453	106104	252	106299	161	113134	382	114641	96	118853	204
105668	459	105765	252	105933	453	106105	252	106300	161	113135	382	114642	96	118857	204
105669	459	105766	252	105934	453	106106	252	106303	161	113136	382	114643	96	118858	204
105670	459	105767	252	105935	453	106107	252	106304	162	113137	382	114644	96	118859	204
105670	459	105768	252	105936	453	106108	252	106305							



# Part Number Index

BradyID.com/s34

Catalog #	Pg	Catalog #	Pg	Catalog #	Pg	Catalog #	Pg	Catalog #	Pg	Catalog #	Pg	Catalog #	Pg	Catalog #	Pg	Catalog #	Pg
120856	349	121151	209	121519	462	121720	268	121764	214	121807	268	121851	214	121894	268	122296	263
120857	349	121152	209	121520	462	121721	214	121764	268	121808	268	121851	268	121895	214	122297	263
120858	349	121153	209	121521	263	121721	268	121765	214	121808	268	121852	214	121895	268	122298	263
120859	349	121154	209	121522	263	121722	214	121765	268	121809	214	121852	268	121896	214	122299	263
120860	349	121155	209	121540	477	121722	268	121766	214	121809	268	121853	214	121896	268	122300	263
120862	349	121156	209	121541	477	121723	214	121766	268	121810	214	121853	268	121897	214	122301	263
120863	349	121157	209	121543	384	121723	268	121767	214	121810	268	121854	214	121897	268	122302	263
120864	349	121158	209	121544	384	121724	214	121767	268	121811	214	121854	268	121898	214	122303	263
120865	349	121159	209	121545	384	121724	268	121768	214	121811	268	121855	214	121898	268	122304	263
120866	349	121161	208	121546	384	121725	214	121768	268	121812	214	121855	268	121899	214	122305	263
120867	349	121163	208	121547	384	121725	268	121769	214	121812	268	121856	214	121899	268	122306	263
120994	353	121164	208	121548	384	121726	214	121769	268	121813	214	121856	268	121900	214	122307	263
120994	355	121165	208	121549	384	121726	268	121770	214	121813	268	121857	214	121900	268	122308	263
121033	271	121183	211	121550	384	121727	214	121770	268	121814	214	121857	268	121901	214	122309	263
121034	271	121184	211	121551	384	121727	268	121771	214	121814	268	121858	214	121901	268	122310	263
121035	271	121185	211	121552	384	121728	214	121771	268	121815	214	121858	268	121902	214	122311	263
121036	271	121186	211	121553	384	121728	268	121772	214	121815	268	121859	214	121902	268	122312	263
121037	271	121187	211	121554	384	121729	214	121772	268	121816	214	121859	268	121903	214	122313	263
121038	271	121364	269	121555	384	121729	268	121773	214	121816	268	121860	214	121903	268	122314	263
121039	271	121365	269	121556	384	121730	214	121773	268	121817	214	121860	268	121904	214	122337	103
121040	271	121366	269	121557	384	121730	268	121774	214	121817	268	121861	214	121904	268	122338	92
121041	271	121367	269	121558	384	121731	214	121774	268	121818	214	121861	268	121905	214	122339	104
121042	271	121368	269	121559	384	121731	268	121775	214	121818	268	121862	214	121905	268	122340	104
121043	271	121369	269	121560	384	121732	214	121775	268	121819	214	121862	268	121906	214	122341	105
121044	271	121370	211	121561	384	121732	268	121776	214	121819	268	121863	214	121906	268	122342	140
121045	271	121371	211	121562	384	121733	214	121776	268	121820	214	121863	268	121907	214	122343	77
121046	271	121399	271	121563	384	121733	268	121777	214	121820	268	121864	214	121907	268	122344	34
121047	271	121400	271	121564	384	121734	214	121777	268	121821	214	121864	268	121908	214	122345	104
121048	271	121401	271	121691	214	121734	268	121778	214	121821	268	121865	214	121908	268	122347	59
121049	271	121402	271	121691	268	121735	214	121778	268	121822	214	121865	268	121909	214	122349	108
121050	271	121403	271	121692	214	121735	268	121779	214	121822	268	121866	214	121909	268	122350	134
121051	271	121404	271	121692	268	121736	214	121779	268	121823	214	121866	268	121910	214	122351	109
121056	208	121405	271	121693	214	121736	268	121780	214	121823	268	121867	214	121910	268	122352	90
121061	209	121406	271	121693	268	121737	214	121780	268	121824	214	121867	268	121911	214	122353	88
121062	209	121407	271	121694	214	121737	268	121781	214	121824	268	121868	214	121911	268	122355	88
121063	209	121408	271	121694	268	121738	214	121781	268	121825	214	121868	268	121912	214	122356	167
121064	209	121409	271	121695	214	121738	268	121782	214	121825	268	121869	214	121912	268	122357	167
121065	210	121410	271	121695	268	121739	214	121782	268	121826	214	121869	268	121913	265	122358	168
121066	210	121411	271	121696	214	121739	268	121783	214	121826	268	121870	214	121914	265	122359	167
121067	210	121412	271	121696	268	121740	214	121783	268	121827	214	121870	268	121915	265	122360	101
121068	210	121413	270	121697	214	121740	268	121784	214	121827	268	121871	214	121916	265	122361	108
121069	210	121414	270	121697	268	121741	214	121784	268	121828	214	121871	268	121917	265	122362	108
121070	210	121415	270	121698	214	121741	268	121785	214	121828	268	121872	214	121918	265	122363	167
121071	210	121416	270	121698	268	121742	214	121785	268	121829	214	121872	268	121918	265	122364	169
121077	218	121417	270	121699	214	121742	268	121786	214	121829	268	121873	214	122049	263	122365	135
121078	218	121418	270	121699	268	121743	214	121786	268	121830	214	121873	268	122050	263	122366	135
121079	218	121419	270	121700	214	121743	268	121787	214	121830	268	121874	214	122051	263	122367	169
121080	218	121420	270	121700	268	121744	214	121787	268	121831	214	121874	268	122052	263	122368	169
121083	218	121421	270	121701	214	121744	268	121788	214	121831	268	121875	214	122053	263	122369	169
121084	218	121422	270	121701	268	121745	214	121788	268	121832	214	121875	268	122054	263	122370	35
121085	218	121431	209	121702	214	121745	268	121789	214	121832	268	121876	214	122055	263	122371	169
121086	218	121432	209	121702	268	121746	214	121789	268	121833	214	121876	268	122056	263	122372	167
121087	218	121433	209	121703	214	121746	268	121790	214	121833	268	121877	214	122057	263	122373	169
121088	218	121434	209	121703	268	121747	214	121790	268	121834	214	121877	268	122058	263	122374	169
121091	218	121435	209	121704	214	121747	268	121791	214	121834	268	121878	214	122059	263	122375	168
121092	218	121436	209	121704	268	121748	214	121791	268	121835	214	121878	268	122060	263	122376	168
121093	218	121437	209	121705	214	121748	268	121792	214	121835	268	121879	214	122061	263	122377	103
121094	218	121438	209	121705	268	121749	214	121792	268	121836	214	121879	268	122062	263	122378	175
121095	218	121439	209	121706	214	121749	268	121793	214	121836	268	121880	214	122063	263	122379	109
121096	218	121440	209	121706	268	121750	214	121793	268	121837	214	121880	268	122064	263	122380	137
121097	218	121441	210	121707	214	121750	268	121794	214	121837	268	121881	214	122065	263	122381	148
121098	218	121448	470	121707	268	121751	214	121794	268	121838	214	121881	268	122066	263	122382	57
121099	218	121449	470	121708	214	121751	268	121795	214	121838	268	121882	214	122067	263	122383	61
121100	218	121466	210	121708	268	121752	214	121795	268	121839	214	121882	268	122068	263	122384	137
121101	218	121467	210	121709	214	121752	268	121796	214	121839	268	121883	214	122069	263	122385	33
121102	218	121468	210	121709	268	121753	214	121796	268	121840	214	121883	268	122070	263	122386	67
121103	218	121469	210	121710	214	121753	268	121797	214	121840	268	121884	214	122071	263	122387	59
121104	218	121470	210	121710	268	121754	214	121797	268	121841	214	121884	268	122072	263	122388	55
121117	270	121471	210	121711	214	121754	268	121798	214	121841	268	121885	214	122073	263	122	

# Part Number Index

BradyID.com/s34

Part Number Index

Catalog #	Pg	Catalog #	Pg	Catalog #	Pg	Catalog #	Pg	Catalog #	Pg	Catalog #	Pg	Catalog #	Pg	Catalog #	Pg	Catalog #	Pg
122417	134	122523	177	122631	58	122735	121	122833	145	123241	468	123328	467	123465	35	123552	34
122418	90	122524	133	122632	103	122736	167	122834	142	123242	468	123329	467	123466	35	123553	34
122419	88	122525	33	122633	93	122737	169	122835	135	123243	468	123330	467	123467	35	123554	34
122421	88	122526	152	122635	92	122738	135	122836	147	123244	468	123331	467	123468	35	123555	34
122422	167	122527	90	122636	93	122739	135	122837	147	123245	468	123332	467	123469	35	123556	34
122423	167	122528	88	122637	77	122740	169	122838	64	123246	468	123333	467	123470	35	123557	158
122424	168	122530	88	122638	119	122741	169	122839	144	123247	468	123334	467	123471	35	123558	158
122425	167	122531	167	122639	34	122742	169	122840	125	123248	468	123335	467	123472	35	123559	158
122426	101	122532	167	122640	59	122743	127	122841	145	123249	468	123336	467	123473	35	123560	158
122427	108	122533	168	122641	55	122744	35	122842	65	123250	468	123337	467	123474	33	123561	158
122428	108	122534	167	122642	52	122745	169	122843	121	123251	468	123338	467	123475	33	123562	158
122429	102	122535	101	122643	51	122746	168	122844	86	123252	468	123339	467	123476	33	123563	128
122430	121	122536	108	122644	51	122747	169	122845	121	123253	468	123340	467	123477	33	123564	128
122431	167	122537	108	122645	50	122748	168	122846	146	123254	468	123341	467	123478	33	123565	128
122432	169	122538	102	122646	58	122749	168	122847	146	123255	468	123342	467	123479	33	123566	128
122433	135	122539	121	122647	56	122750	77	122848	123	123256	468	123343	467	123480	169	123567	128
122434	135	122540	167	122648	57	122752	103	122849	157	123257	468	123344	467	123481	169	123568	128
122435	169	122541	169	122649	83	122753	48	122850	32	123258	468	123345	467	123482	169	123569	151
122436	169	122542	135	122650	67	122754	38	122851	33	123259	468	123346	467	123483	169	123570	151
122437	169	122543	135	122651	100	122756	30	122852	33	123260	468	123347	467	123484	169	123571	151
122438	127	122544	169	122652	123	122757	92	122853	108	123261	468	123348	467	123485	169	123572	151
122439	35	122545	169	122653	157	122758	57	122854	31	123262	468	123349	467	123486	169	123573	151
122440	169	122546	169	122654	31	122760	65	122855	177	123263	468	123350	467	123487	169	123574	151
122441	168	122547	127	122655	133	122762	144	122856	33	123264	468	123351	467	123488	169	123575	150
122442	169	122548	35	122656	90	122764	109	122857	33	123265	468	123352	467	123489	35	123576	150
122443	168	122549	169	122658	167	122765	177	122858	109	123266	468	123353	467	123490	35	123577	150
122444	168	122550	168	122659	167	122766	87	122859	152	123267	468	123354	467	123491	35	123578	150
122447	175	122551	169	122660	168	122767	147	122860	134	123268	466	123355	467	123492	35	123579	150
122449	144	122552	168	122661	167	122768	33	122861	90	123269	466	123356	467	123493	35	123580	167
122451	109	122553	168	122662	108	122770	67	122862	88	123270	466	123357	467	123494	35	123587	150
122452	177	122554	77	122663	108	122774	105	122864	88	123271	466	123358	467	123495	87	123588	167
122453	87	122557	144	122664	108	122775	104	122865	167	123272	468	123359	467	123496	35	123589	167
122454	37	122559	177	122665	102	122776	118	122866	167	123273	468	123396	467	123497	35	123590	167
122455	147	122560	33	122666	121	122777	156	122867	168	123274	468	123397	467	123498	35	123591	167
122456	33	122562	67	122667	119	122778	119	122868	33	123275	468	123398	467	123499	35	123592	167
122458	67	122565	92	122671	167	122779	55	122869	167	123276	468	123399	467	123500	35	123593	167
122459	33	122566	104	122672	169	122780	52	122870	101	123277	468	123400	467	123501	35	123594	167
122463	103	122567	105	122673	135	122781	51	122871	108	123278	468	123401	467	123502	34	123595	167
122464	92	122568	34	122674	135	122782	51	122872	108	123279	468	123402	467	123503	34	123596	167
122465	104	122569	34	122675	169	122783	50	122873	102	123280	468	123403	467	123504	34	123597	167
122466	104	122570	104	122676	169	122784	58	122874	121	123281	468	123404	467	123505	34	123598	167
122467	105	122572	59	122677	169	122785	56	122875	167	123282	468	123405	467	123506	34	123599	167
122468	140	122573	42	122678	127	122786	57	122876	169	123283	468	123406	467	123507	34	123600	167
122469	77	122574	46	122679	35	122787	83	122877	135	123284	469	123407	467	123508	34	123601	167
122470	34	122575	38	122680	35	122788	89	122878	135	123285	469	123408	467	123509	34	123602	167
122471	104	122576	120	122681	169	122789	142	122879	169	123286	469	123409	467	123510	34	123603	167
122473	108	122577	123	122682	168	122790	103	122880	169	123287	469	123410	467	123511	34	123604	167
122474	134	122578	157	122683	169	122793	92	122881	169	123288	469	123411	467	123512	34	123605	84
122475	109	122579	90	122684	168	122794	104	122882	127	123289	469	123412	467	123513	34	123606	84
122476	90	122581	167	122685	168	122795	140	122883	35	123290	469	123413	467	123514	158	123607	84
122477	88	122582	167	122688	103	122796	140	122884	35	123291	469	123414	467	123515	158	123608	84
122479	88	122583	168	122689	38	122797	141	122885	169	123292	469	123415	467	123516	158	123609	84
122480	167	122584	167	122691	175	122798	77	122886	168	123293	469	123416	467	123517	158	123610	84
122481	101	122585	101	122692	144	122799	119	122887	169	123294	469	123417	467	123518	158	123611	90
122482	108	122586	108	122694	109	122800	34	122888	168	123295	469	123418	467	123519	158	123612	90
122483	108	122587	108	122695	177	122801	34	122889	168	123296	469	123419	467	123520	169	123613	90
122484	121	122588	108	122697	33	122802	59	122890	77	123297	469	123420	467	123521	169	123614	90
122485	35	122589	121	122702	103	122803	55	122892	103	123298	469	123421	467	123522	169	123615	90
122486	168	122590	119	122703	140	122804	52	122894	30	123299	469	123422	467	123523	169	123616	90
122487	168	122591	167	122705	92	122805	51	122895	73	123300	469	123423	467	123524	169	123617	29
122488	168	122595	169	122706	104	122806	51	122897	175	123301	469	123424	467	123525	169	123618	29
122489	77	122596	135	122707	105	122807	50	122898	65	123302	469	123425	467	123526	167	123619	29
122491	103	122597	135	122708	34	122808	58	122900	144	123303	469	123426	467	123527	167	123620	29
122493	175	122598	169	122709	34	122809	56	122902	109	123304	469	123427	467	123528	167	123621	29
122495	109	122599	169	122710	104	122810	57	122903	177	123305	469	123428	467	123529	167	123622	29
122496	138	122600	169	122712	59	122811	70	122904	87	123306	469	123429	467	123530	167	123623	84
122497	33	122601	127	122713	70	122812	83	122905	37	123307	469	123430	467	123531	167	123624	84
122499	67	122602	35	122714	29	122813	41	122906	138	123308	469	123431	467	123532	169	123625	84
122503	89	122603	169	122715	46	122814	125	122907	33	123309	469	123432	469	123533	169	123626	84
122505	77	122604	168	122716	120	122815	68	122909	67	123310	469	123433					

# Part Number Index

BradyID.com/s34

Catalog #	Pg	Catalog #	Pg	Catalog #	Pg	Catalog #	Pg	Catalog #	Pg	Catalog #	Pg	Catalog #	Pg	Catalog #	Pg		
123645	83	123738	126	123825	154	123912	141	124001	58	124092	53	124179	60	124266	82	124353	179
123646	83	123739	126	123826	154	123913	141	124002	58	124093	53	124180	60	124267	82	124354	179
123647	83	123740	126	123827	152	123914	141	124003	58	124094	53	124181	156	124268	82	124355	179
123648	83	123741	126	123828	152	123915	140	124004	58	124095	53	124182	156	124269	82	124356	180
123649	83	123742	126	123829	152	123916	140	124005	58	124096	53	124183	156	124270	82	124357	180
123650	83	123743	126	123830	152	123917	140	124006	58	124097	52	124184	156	124271	79	124358	180
123651	83	123744	126	123831	152	123918	140	124007	56	124098	52	124185	156	124272	179	124365	183
123652	83	123745	126	123832	152	123919	140	124008	56	124099	52	124186	156	124273	179	124366	183
123653	71	123746	126	123833	131	123920	140	124009	56	124100	52	124187	176	124274	120	124367	183
123654	71	123747	126	123834	131	123921	141	124010	56	124101	52	124188	176	124275	120	124368	184
123655	71	123748	126	123835	131	123922	141	124011	56	124102	52	124189	176	124276	120	124369	184
123656	71	123749	109	123836	131	123923	141	124012	56	124103	53	124190	176	124277	120	124370	184
123657	71	123750	109	123837	131	123924	141	124013	53	124104	53	124191	176	124278	120	124371	187
123658	71	123751	109	123838	131	123925	141	124014	53	124105	53	124192	176	124279	120	124372	187
123659	66	123752	109	123839	131	123926	141	124015	53	124106	53	124193	176	124280	65	124373	187
123660	66	123753	109	123840	131	123927	141	124016	53	124107	53	124194	176	124281	65	124374	187
123661	66	123754	109	123841	131	123928	141	124017	53	124108	53	124195	176	124282	65	124375	187
123662	66	123755	103	123842	131	123929	141	124018	53	124109	60	124196	176	124283	65	124376	187
123663	66	123756	103	123843	131	123930	141	124019	59	124110	60	124197	176	124284	65	124377	181
123664	66	123757	103	123844	131	123931	141	124020	59	124111	60	124198	176	124285	65	124378	181
123665	70	123758	103	123845	131	123932	141	124021	59	124112	60	124199	179	124286	82	124379	181
123666	70	123759	103	123846	131	123933	141	124022	59	124113	60	124200	179	124287	82	124380	181
123667	70	123760	103	123847	131	123934	141	124023	59	124114	60	124201	179	124288	82	124381	181
123668	70	123761	104	123848	131	123935	141	124024	59	124115	55	124202	179	124289	82	124382	181
123669	70	123762	104	123849	131	123936	141	124025	58	124116	55	124203	179	124290	82	124383	184
123670	70	123763	104	123850	131	123937	141	124026	58	124117	55	124204	179	124291	82	124384	184
123671	83	123764	104	123851	130	123938	141	124027	58	124118	55	124205	176	124292	145	124385	184
123672	83	123765	104	123852	130	123939	140	124028	58	124119	55	124206	176	124293	145	124386	178
123673	83	123766	104	123853	130	123940	140	124029	58	124120	55	124207	176	124294	145	124387	178
123674	83	123767	103	123854	130	123941	140	124030	58	124121	54	124208	176	124295	145	124388	178
123675	83	123768	103	123855	130	123942	140	124031	56	124122	54	124209	176	124296	145	124389	183
123676	83	123769	103	123856	130	123943	140	124032	56	124123	54	124210	176	124297	145	124390	183
123677	149	123770	103	123857	77	123944	140	124033	56	124124	54	124211	176	124298	156	124391	183
123678	149	123771	103	123858	77	123945	158	124034	56	124125	54	124212	176	124299	156	124392	181
123679	149	123772	103	123859	77	123946	158	124035	56	124126	54	124213	176	124300	156	124393	181
123680	149	123773	102	123860	77	123947	158	124036	56	124127	59	124214	176	124301	156	124394	181
123681	149	123774	102	123861	77	123948	158	124037	56	124128	59	124215	176	124302	156	124395	186
123682	149	123775	102	123862	77	123949	158	124038	56	124129	59	124216	176	124303	156	124396	186
123683	127	123776	102	123863	131	123950	158	124039	56	124130	59	124217	176	124304	87	124397	186
123684	127	123777	102	123864	131	123951	130	124040	56	124131	59	124218	176	124305	183	124398	187
123685	127	123778	102	123865	131	123952	130	124041	56	124132	59	124219	176	124306	183	124399	187
123686	127	123779	103	123866	131	123953	130	124042	56	124133	58	124220	176	124307	183	124400	187
123687	127	123780	103	123867	131	123954	130	124043	55	124134	58	124221	176	124308	181	124401	182
123688	127	123781	103	123868	131	123955	130	124044	55	124135	58	124222	176	124309	181	124402	182
123689	68	123782	103	123869	173	123956	130	124045	55	124136	58	124223	143	124310	181	124403	182
123690	68	123783	103	123870	173	123957	158	124046	55	124137	58	124224	143	124311	182	124404	180
123691	68	123784	103	123871	173	123958	158	124047	55	124138	58	124225	143	124312	182	124405	180
123692	68	123785	92	123872	173	123959	158	124048	55	124139	53	124226	143	124313	182	124406	180
123693	68	123786	92	123873	173	123960	158	124049	50	124140	53	124227	143	124314	187	124407	182
123694	68	123787	92	123874	173	123961	158	124050	50	124141	53	124228	143	124315	187	124408	182
123695	89	123788	92	123875	172	123962	158	124051	50	124142	53	124229	156	124316	187	124409	182
123696	89	123789	92	123876	172	123963	158	124052	50	124143	53	124230	156	124317	181	124410	181
123697	89	123790	92	123877	172	123964	158	124053	50	124144	53	124231	156	124318	181	124411	181
123698	89	123791	94	123878	172	123965	158	124054	50	124145	55	124232	156	124319	181	124412	181
123699	89	123792	94	123879	159	123966	158	124055	50	124146	55	124233	156	124320	181	124413	181
123700	89	123793	94	123880	159	123967	158	124056	50	124147	55	124234	156	124321	181	124414	181
123701	30	123794	94	123881	159	123968	158	124057	50	124148	55	124235	82	124322	181	124415	181
123702	30	123795	94	123882	159	123969	158	124058	50	124149	55	124236	82	124323	181	124416	186
123703	30	123796	94	123883	159	123970	159	124059	50	124150	55	124237	82	124324	181	124417	186
123704	30	123797	94	123884	159	123971	159	124060	50	124151	59	124238	82	124325	181	124418	186
123705	30	123798	94	123885	173	123972	159	124061	53	124152	59	124239	82	124326	180	124419	185
123706	30	123799	94	123886	173	123973	159	124062	53	124153	59	124240	82	124327	180	124420	185
123707	68	123800	94	123887	173	123974	159	124063	53	124154	59	124241	121	124328	180	124421	185
123708	68	123801	94	123888	173	123975	159	124064	53	124155	59	124242	121	124329	184	124422	185
123709	68	123802	94	123889	173	123976	159	124065	53	124156	59	124243	121	124330	184	124423	185
123710	68	123803	92	123890	173	123977	159	124066	53	124157	59	124244	121	124331	184	124424	185
123711	68	123804	92	123891	139	123978	159	124067	53	124158	59	124245	121	124332	181	124425	181
123712	68	123805	92	123892	139	123979	159	124068	53	124159	59	124246	121	124333	181	124426	181
123713	82	123806	92	123893	139	123980	159	124069	53	124160	59	124247	145	124334	181	124427	181
123714	82	123807	92	123894	139	123981	159	124070	54	124161	59	124248	145	124335	182	124428	186
123715	82	123808	92	123895	139	123											

# Part Number Index

BradyID.com/s34

Part Number Index

Catalog #	Pg	Catalog #	Pg	Catalog #	Pg	Catalog #	Pg	Catalog #	Pg	Catalog #	Pg	Catalog #	Pg	Catalog #	Pg	Catalog #	Pg
124446	186	124533	185	124620	178	124707	28	124794	30	124881	35	124973	57	125060	57	125147	52
124447	186	124534	185	124621	178	124708	28	124795	30	124882	35	124974	57	125061	56	125148	52
124448	186	124535	185	124622	153	124709	28	124796	30	124883	35	124975	57	125062	56	125149	52
124449	185	124536	185	124623	153	124710	28	124797	30	124884	35	124976	57	125063	56	125150	52
124450	185	124537	185	124624	153	124711	28	124798	30	124885	35	124977	56	125064	56	125151	53
124451	185	124538	185	124625	87	124712	28	124799	30	124886	35	124978	56	125065	56	125152	53
124452	187	124539	185	124626	87	124713	28	124800	30	124887	35	124979	56	125066	56	125153	53
124453	187	124540	185	124627	87	124714	28	124801	30	124888	35	124980	56	125067	56	125154	53
124454	187	124541	185	124628	87	124715	28	124802	30	124889	35	124981	56	125068	56	125155	53
124455	182	124542	186	124629	87	124716	28	124803	34	124890	35	124982	56	125069	56	125156	53
124456	182	124543	186	124630	87	124717	28	124804	34	124891	35	124983	57	125070	56	125157	52
124457	182	124544	186	124631	158	124718	28	124805	34	124892	35	124984	57	125071	56	125158	52
124458	180	124545	186	124632	158	124719	28	124806	34	124893	58	124985	57	125072	56	125159	52
124459	180	124546	186	124633	158	124720	28	124807	30	124894	58	124986	57	125073	56	125160	52
124460	180	124547	186	124634	159	124721	28	124808	34	124895	58	124987	57	125074	56	125161	52
124461	179	124548	186	124635	159	124722	28	124809	31	124898	58	124988	57	125075	56	125162	52
124462	179	124549	186	124636	159	124723	28	124810	31	124899	58	124989	56	125076	56	125163	52
124463	179	124550	185	124637	159	124724	28	124811	31	124900	58	124990	56	125077	56	125164	52
124464	184	124551	185	124638	159	124725	29	124812	31	124901	58	124991	56	125078	56	125165	52
124465	184	124552	185	124639	159	124726	29	124813	31	124902	58	124992	56	125079	56	125166	52
124466	184	124553	185	124640	140	124727	29	124814	31	124903	58	124993	56	125080	56	125167	52
124467	187	124554	185	124641	140	124728	29	124815	31	124904	58	124994	56	125081	56	125168	52
124468	187	124555	185	124642	140	124729	29	124816	31	124905	60	124995	56	125082	56	125169	54
124469	187	124556	185	124643	60	124730	29	124817	31	124906	60	124996	56	125083	56	125170	54
124470	187	124557	185	124644	60	124731	29	124818	31	124907	60	124997	56	125084	56	125171	54
124471	187	124558	186	124645	60	124732	29	124819	31	124908	60	124998	56	125085	57	125172	54
124472	187	124559	186	124646	60	124733	29	124820	31	124909	60	124999	56	125086	57	125173	54
124473	184	124560	186	124647	28	124734	29	124821	31	124910	60	125000	56	125087	57	125174	54
124474	184	124561	186	124648	28	124735	29	124822	31	124911	50	125001	57	125088	57	125175	54
124475	184	124562	58	124649	28	124736	29	124823	31	124912	50	125002	57	125089	57	125176	54
124476	186	124563	58	124650	28	124737	29	124824	31	124913	50	125003	57	125090	57	125177	54
124477	186	124564	58	124651	28	124738	29	124825	31	124914	50	125004	57	125091	60	125178	54
124478	186	124565	103	124652	28	124739	29	124826	31	124915	50	125005	57	125092	60	125179	54
124479	186	124566	103	124653	28	124740	29	124827	31	124916	50	125006	57	125093	60	125180	54
124480	186	124567	103	124654	28	124741	29	124828	31	124917	51	125007	56	125094	60	125181	54
124481	186	124568	104	124655	28	124742	29	124829	31	124918	51	125008	56	125095	60	125182	54
124482	186	124569	104	124656	28	124743	29	124830	31	124919	51	125009	56	125096	60	125183	54
124483	186	124570	104	124657	28	124744	29	124831	31	124920	51	125010	56	125097	53	125184	54
124484	186	124571	60	124658	28	124745	29	124832	31	124921	51	125011	56	125098	53	125185	54
124485	185	124572	60	124659	28	124746	29	124833	32	124922	51	125012	56	125099	53	125186	54
124486	185	124573	60	124660	28	124747	29	124834	32	124923	51	125013	56	125100	53	125187	55
124487	185	124574	60	124661	28	124748	29	124835	32	124924	51	125014	56	125101	53	125188	55
124488	185	124575	182	124662	28	124749	30	124836	32	124925	51	125015	56	125102	53	125189	55
124489	185	124576	182	124663	28	124750	30	124837	32	124926	51	125016	56	125103	53	125190	55
124490	185	124577	182	124664	28	124751	30	124838	32	124927	51	125017	56	125104	53	125191	55
124491	184	124578	182	124665	28	124752	30	124839	35	124928	51	125018	56	125105	53	125192	55
124492	184	124579	178	124666	28	124753	30	124840	35	124929	51	125019	57	125106	53	125193	55
124493	184	124580	178	124667	28	124754	30	124841	35	124930	51	125020	57	125107	53	125194	55
124494	184	124581	178	124668	28	124755	29	124842	35	124931	51	125021	57	125108	53	125195	55
124495	184	124582	178	124669	28	124756	29	124843	35	124932	51	125022	57	125109	55	125196	55
124496	184	124583	185	124670	28	124757	29	124844	35	124933	51	125023	57	125110	55	125197	55
124497	184	124584	185	124671	28	124758	29	124845	34	124934	51	125024	57	125111	55	125198	55
124498	184	124585	185	124672	28	124759	29	124846	34	124935	52	125025	57	125112	55	125199	53
124499	184	124586	185	124673	28	124760	29	124847	34	124936	52	125026	57	125113	55	125200	53
124500	184	124587	187	124674	28	124761	29	124848	34	124937	52	125027	57	125114	55	125201	53
124501	184	124588	187	124675	28	124762	29	124849	34	124938	52	125028	57	125115	52	125202	53
124502	184	124589	187	124676	28	124763	29	124850	34	124939	52	125029	57	125116	52	125203	53
124503	183	124590	187	124677	28	124764	29	124851	35	124940	52	125030	57	125117	52	125204	53
124504	183	124591	179	124678	28	124765	29	124852	35	124941	53	125031	56	125118	52	125205	53
124505	183	124592	179	124679	28	124766	29	124853	35	124942	53	125032	56	125119	52	125206	53
124506	186	124593	179	124680	28	124767	30	124854	35	124943	53	125033	56	125120	52	125207	53
124507	186	124594	179	124681	28	124768	30	124855	35	124944	53	125034	56	125121	55	125208	53
124508	186	124595	181	124682	28	124769	30	124856	35	124945	53	125035	56	125122	55	125209	53
124509	186	124596	181	124683	28	124770	30	124857	35	124946	53	125036	56	125123	55	125210	53
124510	186	124597	181	124684	28	124771	30	124858	35	124947	53	125037	57	125124	55	125211	54
124511	186	124598	181	124685	28	124772	30	124859	35	124948	53	125038	57	125125	55	125212	54
124512	186	124599	187	124686	28	124773	30	124860	35	124949	53	125039	57	125126	55	125213	54
124513	186	124600	187	124687	28	124774	30	124861	35	124950	53	125040	57	125127	52	125214	54
124514	186	124601	187	124688	28	124775	30	124862	35	124951	54	125041	57	125128	52	125215	54
124515	186	124602	187	124689	28	124776	30	124863	34	124952	54	125042	57	125129	52	125216	54
124516	186	124603	187	124690	28	124777	30	124864	34	124953	54	125043	57	125130	52	125217	55
124517	186	124604	187	124691	28	124778											





# Part Number Index

BradyID.com/s34

Catalog #	Pg	Catalog #	Pg	Catalog #	Pg	Catalog #	Pg	Catalog #	Pg	Catalog #	Pg	Catalog #	Pg	Catalog #	Pg
126825	84	126912	85	126999	88	127086	91	127173	101	127260	105	127347	100	127434	108
126826	84	126913	85	127000	88	127087	91	127174	101	127261	105	127348	100	127435	108
126827	84	126914	85	127001	88	127088	91	127175	101	127262	105	127349	100	127436	108
126828	84	126915	85	127002	89	127089	91	127176	101	127263	105	127350	100	127437	108
126829	84	126916	85	127003	89	127090	91	127177	101	127264	105	127351	100	127438	108
126830	84	126917	85	127004	89	127091	91	127178	101	127265	105	127352	100	127439	108
126831	84	126918	85	127005	89	127092	87	127179	101	127266	105	127353	100	127440	108
126832	84	126919	85	127006	89	127093	87	127180	101	127267	105	127354	100	127441	108
126833	84	126920	85	127007	89	127094	87	127181	101	127268	105	127355	100	127442	108
126834	84	126921	85	127008	89	127095	87	127182	101	127269	105	127356	100	127443	108
126835	84	126922	85	127009	89	127096	87	127183	101	127270	105	127357	100	127444	108
126836	84	126923	85	127010	89	127097	87	127184	101	127271	105	127358	100	127445	108
126837	84	126924	85	127011	89	127098	95	127185	101	127272	105	127359	100	127446	108
126838	84	126925	85	127012	89	127099	95	127186	101	127273	105	127360	100	127447	108
126839	84	126926	85	127013	89	127100	95	127187	101	127274	105	127361	100	127448	108
126840	85	126927	85	127014	89	127101	95	127188	102	127275	105	127362	100	127449	108
126841	85	126928	85	127015	89	127102	95	127189	102	127276	105	127363	100	127450	108
126842	85	126929	85	127016	89	127103	95	127190	102	127277	105	127364	100	127451	108
126843	85	126930	85	127017	89	127104	91	127191	102	127278	106	127365	100	127452	173
126844	85	126931	85	127018	89	127105	91	127192	102	127279	106	127366	100	127453	173
126845	85	126932	85	127019	89	127106	91	127193	102	127280	106	127367	100	127454	173
126846	85	126933	85	127020	89	127107	91	127194	102	127281	106	127368	100	127455	173
126847	85	126934	85	127021	89	127108	91	127195	102	127282	106	127369	100	127456	173
126848	85	126935	85	127022	89	127109	91	127196	102	127283	106	127370	100	127457	173
126849	85	126936	88	127023	89	127110	101	127197	102	127284	106	127371	100	127458	173
126850	85	126937	88	127024	89	127111	101	127198	102	127285	106	127372	100	127459	173
126851	85	126938	88	127025	89	127112	101	127199	102	127286	106	127373	100	127460	173
126852	85	126939	88	127026	90	127113	101	127200	103	127287	106	127374	109	127461	173
126853	85	126940	88	127027	90	127114	101	127201	103	127288	106	127375	109	127462	173
126854	85	126941	88	127028	90	127115	101	127202	103	127289	106	127376	109	127463	173
126855	85	126942	88	127029	90	127116	101	127203	103	127290	106	127377	109	127464	173
126856	85	126943	88	127030	90	127117	101	127204	103	127291	106	127378	109	127465	173
126857	85	126944	88	127031	90	127118	101	127205	103	127292	106	127379	109	127466	173
126858	85	126945	88	127032	90	127119	101	127206	103	127293	106	127380	109	127467	173
126859	85	126946	88	127033	90	127120	101	127207	103	127294	106	127381	109	127468	173
126860	85	126947	88	127034	90	127121	101	127208	103	127295	106	127382	109	127469	173
126861	85	126948	88	127035	90	127122	101	127209	103	127296	106	127383	109	127470	173
126862	85	126949	88	127036	90	127123	101	127210	103	127297	106	127384	109	127471	173
126863	85	126950	88	127037	90	127124	101	127211	103	127298	106	127385	109	127472	173
126864	85	126951	88	127038	90	127125	101	127212	102	127299	106	127386	109	127473	173
126865	85	126952	88	127039	90	127126	101	127213	102	127300	106	127387	109	127474	173
126866	85	126953	88	127040	90	127127	101	127214	102	127301	106	127388	109	127475	173
126867	85	126954	88	127041	90	127128	101	127215	102	127302	106	127389	109	127476	173
126868	85	126955	88	127042	90	127129	101	127216	102	127303	106	127390	109	127477	173
126869	85	126956	88	127043	90	127130	101	127217	102	127304	106	127391	109	127478	173
126870	85	126957	88	127044	90	127131	101	127218	104	127305	106	127392	109	127479	173
126871	85	126958	88	127045	90	127132	101	127219	104	127306	106	127393	107	127480	173
126872	85	126959	88	127046	90	127133	101	127220	104	127307	106	127394	107	127481	173
126873	85	126960	88	127047	90	127134	101	127221	104	127308	106	127395	107	127482	173
126874	85	126961	88	127048	90	127135	101	127222	104	127309	106	127396	107	127483	118
126875	85	126962	88	127049	90	127136	101	127223	104	127310	106	127397	107	127484	118
126876	85	126963	88	127050	91	127137	101	127224	104	127311	106	127398	107	127485	118
126877	85	126964	88	127051	91	127138	101	127225	102	127312	106	127399	107	127486	118
126878	85	126965	88	127052	91	127139	101	127226	102	127313	106	127400	107	127487	118
126879	85	126966	88	127053	91	127140	101	127227	102	127314	106	127401	107	127488	118
126880	85	126967	88	127054	91	127141	101	127228	102	127315	106	127402	107	127489	118
126881	85	126968	88	127055	91	127142	101	127229	102	127316	106	127403	107	127490	118
126882	85	126969	88	127056	86	127143	101	127230	102	127317	106	127404	107	127491	118
126883	85	126970	88	127057	86	127144	101	127231	102	127318	106	127405	107	127492	118
126884	85	126971	88	127058	86	127145	101	127232	102	127319	106	127406	107	127493	118
126885	85	126972	88	127059	86	127146	101	127233	102	127320	106	127407	107	127494	118
126886	85	126973	88	127060	86	127147	101	127234	102	127321	106	127408	107	127495	118
126887	85	126974	88	127061	86	127148	101	127235	102	127322	106	127409	107	127496	118
126888	85	126975	88	127062	86	127149	101	127236	105	127323	106	127410	107	127497	118
126889	85	126976	88	127063	86	127150	101	127237	105	127324	106	127411	107	127498	118
126890	85	126977	88	127064	86	127151	101	127238	105	127325	106	127412	107	127499	118
126891	85	126978	88	127065	86	127152	101	127239	105	127326	106	127413	107	127500	118
126892	85	126979	88	127066	86	127153	101	127240	105	127327	106	127414	107	127501	118
126893	85	126980	88	127067	86	127154	101	127241	105	127328	106	127415	107	127502	118
126894	85	126981	88	127068	33	127155	101	127242	105	127329	106	127416	107	127503	118
126895	85	126982	88	127069	33	127156	101	127243	105	127330	106	127417	107	127504	118
126896	85	126983	88	127070	33	127157	101	127244	105	127331	106	127418	107	127505	118
126897	85	126984	88	127071	33	127158	101	127245	105	127332	106	127419	107	127506	118
126898	85	126985	88	127072	33	127159	101	127246	105	127333	106	127420	107	127507	118
126899	85	126986	88	127073	33	127160	101	127247	105	127334	106	127421	107	127508	118
126900	85	126987	88	127074	86	127161	101	127248	105	127335	106	127422	107	127509	118
126901	85	126988	88	127075	86	127162	101	127249	105	127336	106	127423	107	127510	118
126902	85	126989	88	127076	86	127163	101	127250	105	127337	106	127424	107	127511	118
126903	85	126990	89	127077	86	127164	101	127251	105	127338	102	127425	107	127512	









# Part Number Index

BradyID.com/s34

Catalog #	Pg	Catalog #	Pg	Catalog #	Pg	Catalog #	Pg	Catalog #	Pg	Catalog #	Pg	Catalog #	Pg	Catalog #	Pg	Catalog #	Pg
131798	68	131898	75	131991	146	132085	121	132177	92	133207	164	134032	440	139607	98	139694	98
131799	68	131899	75	131992	146	132086	121	132178	92	133207	205	134033	447	139608	98	139695	98
131800	68	131900	75	131993	146	132087	121	132179	92	133208	205	134034	443	139609	98	139696	98
131801	68	131901	75	131994	146	132088	121	132180	92	133209	164	134035	444	139610	98	139697	98
131802	68	131902	75	131995	146	132089	121	132181	92	133209	205	134036	455	139611	98	139698	98
131803	67	131909	145	131996	146	132090	121	132182	92	133261	469	134086	265	139612	98	139699	98
131804	67	131910	145	131997	146	132091	121	132183	92	133262	469	134087	265	139613	98	139700	98
131805	67	131911	145	131998	146	132092	123	132184	94	133263	469	134088	265	139614	98	139703	98
131806	67	131912	145	131999	136	132093	123	132185	94	133264	469	134089	265	139615	98	139704	98
131807	67	131913	145	132000	136	132094	123	132186	94	133265	469	134090	265	139616	98	139705	98
131808	67	131914	145	132001	136	132095	123	132187	94	133266	469	134091	265	139617	98	139706	98
131809	67	131915	147	132002	136	132096	123	132188	94	133267	469	134092	265	139618	98	139707	98
131810	67	131916	147	132003	136	132097	123	132189	94	133268	469	134093	265	139619	98	139708	98
131811	67	131917	147	132004	136	132098	123	132190	94	133269	469	134094	265	139620	98	139709	98
131812	67	131918	147	132005	137	132099	123	132191	94	133270	469	134105	381	139621	98	139710	98
131813	67	131919	147	132006	137	132100	159	132200	91	133271	469	134106	381	139622	98	139711	98
131814	67	131920	147	132007	137	132101	159	132201	91	133272	469	134107	381	139623	98	139712	98
131815	67	131921	145	132008	137	132103	184	132214	47	133273	469	134108	381	139624	98	139713	98
131816	67	131922	145	132009	137	132104	87	132215	47	133274	469	134109	348	139625	98	139714	98
131817	67	131923	145	132010	137	132105	87	132216	47	133275	469	134110	348	139626	98	139715	98
131818	67	131924	145	132011	137	132106	87	132217	47	133276	469	134177	175	139627	98	139716	98
131819	66	131925	145	132012	137	132107	87	132218	47	133277	469	134178	175	139628	98	139717	98
131820	66	131926	145	132020	168	132108	87	132219	47	133278	469	134179	121	139629	98	139718	98
131821	66	131927	145	132021	168	132109	87	132220	47	133279	469	134180	121	139630	98	139719	98
131822	66	131928	145	132022	168	132110	87	132221	47	133280	469	134181	121	139631	98	139720	98
131823	66	131929	145	132023	168	132111	87	132222	114	133281	469	134182	121	139632	98	139721	98
131824	66	131930	145	132024	168	132112	87	132231	48	133282	469	134183	175	139633	98	139722	98
131825	66	131931	145	132025	168	132113	87	132232	48	133283	469	134184	175	139634	98	139723	98
131826	66	131932	145	132026	168	132114	87	132233	48	133284	469	134185	175	139635	98	139724	98
131829	67	131933	145	132027	135	132115	87	132234	48	133285	469	134186	175	139636	98	139725	98
131830	71	131934	145	132028	135	132116	87	132235	48	133286	469	134187	175	139637	98	139726	98
131831	70	131935	145	132029	135	132117	87	132236	48	133287	469	134188	175	139638	98	139727	98
131832	70	131936	145	132030	135	132118	87	132237	48	133288	469	134189	175	139639	98	139728	98
131833	70	131937	145	132031	135	132119	87	132238	48	133289	469	134190	175	139640	98	139729	98
131834	70	131938	145	132032	135	132120	87	132239	113	133290	469	134191	175	139641	98	139730	98
131835	70	131939	145	132033	135	132121	87	132240	48	133291	469	134192	175	139642	98	139731	98
131836	70	131940	145	132034	135	132122	87	132241	48	133292	469	134193	175	139643	98	140736	188
131837	70	131941	145	132035	135	132123	87	132242	48	133293	469	134194	175	139644	98	140737	188
131838	70	131942	145	132036	135	132124	87	132243	48	133294	469	134352	389	139645	98	140738	188
131839	70	131943	143	132037	135	132125	87	132244	48	133295	469	139559	98	139646	98	140739	188
131840	70	131944	143	132038	135	132126	87	132245	48	133296	469	139560	98	139647	98	140740	188
131841	70	131945	143	132039	135	132127	87	132246	48	133481	282	139561	98	139648	98	140741	188
131842	70	131946	143	132040	135	132128	87	132247	48	133482	282	139562	98	139649	98	140742	188
131843	70	131947	143	132041	167	132129	87	140883	393	133483	282	139563	98	139650	98	140743	188
131844	70	131948	143	132042	167	132130	87	132393	393	133484	282	139564	98	139651	98	140744	188
131845	70	131949	143	132043	167	132131	92	140884	393	133485	282	139565	98	139652	98	140745	188
131846	70	131950	143	132044	167	132136	102	132395	393	133486	282	139566	98	139653	98	140746	188
131853	70	131951	146	132045	167	132137	102	132421	232	133487	282	139567	98	139654	98	140747	188
131854	70	131952	146	132046	167	132138	102	132422	232	133488	282	139568	98	139655	98	140748	188
131859	66	131953	146	132047	167	132139	102	132423	232	133489	461	139569	98	139656	98	140749	189
131861	66	131954	146	132048	167	132140	102	132424	232	133490	461	139570	98	139657	98	140750	188
131862	66	131955	146	132049	178	132141	102	132425	232	133491	461	139571	98	139658	98	140751	188
131863	127	131956	146	132050	178	132142	102	132426	489	133492	461	139572	98	139659	98	140752	188
131864	127	131957	146	132051	178	132143	102	132427	489	133493	461	139573	98	139660	98	140753	188
131865	127	131958	146	132052	178	132144	102	132428	205	133494	461	139574	98	139661	98	140754	188
131866	127	131959	146	132053	178	132145	102	132429	205	133495	461	139575	98	139662	98	140755	189
131867	127	131960	146	132054	178	132146	102	132430	265	133496	461	139576	98	139663	98	140756	189
131868	127	131961	146	132055	178	132147	102	132431	265	133497	461	139577	98	139664	98	140757	188
131869	127	131962	146	132056	178	132148	102	132432	265	133498	461	139578	98	139665	98	140758	189
131870	127	131963	146	132057	30	132149	102	132433	265	133499	461	139579	98	139666	98	140759	189
131871	125	131964	146	132058	86	132150	102	132434	265	133544	461	139580	98	139667	98	140760	189
131872	125	131965	146	132059	86	132151	102	132435	265	133545	461	139581	98	139668	98	140761	189
131873	125	131966	146	132060	122	132152	92	132436	265	133546	461	139582	98	139669	98	140762	189
131874	125	131967	146	132061	122	132153	92	132437	265	133547	461	139583	98	139670	98	140763	189
131875	125	131968	146	132062	122	132154	92	132438	265	133548	461	139584	98	139671	98	140764	189
131876	125	131969	146	132063	122	132155	92	132439	265	133549	461	139585	98	139672	98	140765	189
131877	125	131970	146	132064	122	132156	92	132440	265	133550	461	139586	98	139673	98	140766	189
131878	125	131971	146	132065	122	132157	92	132441	265	133551	461	139587	98	139674	98	140767	189
131879	72	131972	146	132066	122	132158	92	132449	169	133552	461	139588	98	139675	98	140768	189
131880	72	131973	146	132067	122	132159	92	132451	169	133553	461	139589	98	139676	98	140769	189
131881	72	131974	146	132068	122	132160	92	132452									

# Part Number Index

BradyID.com/s34

Part Number Index

Catalog #	Pg	Catalog #	Pg	Catalog #	Pg	Catalog #	Pg	Catalog #	Pg	Catalog #	Pg	Catalog #	Pg	Catalog #	Pg
140788	189	141911	46	142161	269	142413	116	142500	117	142587	117	142746	397	143481	137
140789	189	141912	46	142161	386	142414	117	142501	116	142588	117	142747	397	143482	137
140790	189	141913	46	142162	269	142415	117	142502	116	142589	116	142748	397	143483	137
140791	189	141914	46	142162	386	142416	117	142503	116	142590	116	142749	397	143484	137
140792	189	141915	46	142163	269	142417	116	142504	116	142591	117	142750	397	143485	137
140793	189	141916	46	142163	386	142418	117	142505	117	142592	117	142753	397	143486	137
140794	189	141917	46	142164	269	142419	117	142506	116	142593	116	142754	397	143487	137
140795	188	141919	139	142164	386	142420	117	142507	117	142594	117	142755	397	143488	137
140796	188	141920	139	142165	269	142421	116	142508	117	142595	116	142756	397	143489	137
140797	188	141921	139	142165	386	142422	116	142509	116	142596	117	142757	397	143490	137
140798	188	141922	139	142166	269	142423	116	142510	116	142597	116	142758	397	143491	136
140799	189	141923	139	142166	386	142424	116	142511	116	142598	117	142759	397	143492	136
140800	189	141924	139	142167	269	142425	117	142512	117	142599	117	142760	397	143493	136
140801	188	141925	139	142167	386	142426	117	142513	116	142600	116	142762	397	143494	136
140802	188	141926	139	142168	269	142427	116	142514	117	142601	117	142763	397	143495	136
140803	188	141928	139	142168	386	142428	116	142515	117	142602	117	142764	397	143496	136
140804	189	141928	139	142169	269	142429	117	142516	117	142603	116	142765	397	143497	136
140805	189	141929	141	142169	386	142430	117	142517	117	142604	117	142766	397	143498	136
140806	189	141930	141	142170	269	142431	116	142518	117	142605	117	142767	397	143499	136
140807	189	141931	141	142170	386	142432	117	142519	117	142606	116	142768	397	143500	136
140808	189	141932	141	142171	269	142433	116	142520	116	142607	117	142769	397	143501	136
140809	189	141933	141	142171	386	142434	117	142521	116	142608	117	142770	397	143502	136
140810	189	141934	141	142172	269	142435	116	142522	117	142609	116	142771	397	143503	136
140811	189	141935	141	142172	386	142436	117	142523	117	142610	116	142772	397	143504	136
140812	189	141936	141	142173	269	142437	117	142524	117	142611	116	142773	397	143505	141
140813	189	141937	141	142173	386	142438	116	142525	116	142612	116	142774	397	143506	141
140814	189	141938	141	142174	269	142439	117	142526	117	142613	117	142775	397	143507	141
140815	189	141939	138	142174	386	142440	117	142527	117	142614	116	142776	397	143508	141
140816	189	141940	138	142175	269	142441	116	142528	117	142615	117	142777	397	143509	145
140817	189	141941	138	142175	386	142442	117	142529	116	142616	117	142778	398	143510	45
140818	189	141942	138	142176	269	142443	117	142530	116	142617	116	142779	398	143511	45
140819	188	141943	138	142176	386	142444	116	142531	116	142618	116	142780	398	143512	45
140820	188	141944	138	142177	266	142445	117	142532	116	142619	116	142781	398	143513	45
140821	188	141945	138	142178	266	142446	117	142533	117	142620	117	142782	397	143514	45
140822	188	141946	138	142179	266	142447	116	142534	117	142621	116	142783	397	143515	45
140823	188	141947	138	142180	266	142448	116	142535	116	142622	117	142784	397	143516	38
140824	189	141948	138	142181	266	142449	116	142536	116	142623	117	142785	397	143517	38
140825	189	141949	138	142267	300	142450	116	142537	117	142624	117	142786	398	143518	38
140826	188	141950	138	142268	300	142451	117	142538	117	142625	117	142787	398	143519	38
140827	189	141951	138	142269	342	142452	116	142539	116	142626	117	142788	398	143520	38
140828	188	141952	138	142270	342	142453	117	142540	117	142627	117	142789	398	143521	38
140829	188	141953	138	142271	342	142454	117	142541	116	142628	116	142790	398	143522	46
140830	188	141954	139	142272	342	142455	116	142542	117	142629	116	142791	397	143523	46
140831	188	141955	139	142273	342	142456	116	142543	116	142630	117	142792	397	143524	46
140832	189	141956	139	142274	342	142457	116	142544	117	142631	117	142793	397	143525	46
141660	174	141957	139	142275	342	142458	117	142545	117	142632	117	143123	466	143672	46
141661	174	141958	139	142276	342	142459	116	142546	116	142633	116	143126	468	143673	46
141662	174	141959	139	142277	342	142460	117	142547	117	142634	117	143128	468	143674	46
141663	174	141960	139	142278	342	142461	117	142548	117	142635	117	143130	468	143675	46
141664	174	141961	139	142279	342	142462	117	142549	116	142636	117	143132	468	143676	46
141665	174	141962	139	142280	342	142463	117	142550	117	142637	116	143134	468	143677	46
141666	174	141963	139	142281	342	142464	117	142551	117	142638	116	143136	468	143678	46
141667	174	141964	139	142282	342	142465	117	142552	116	142639	116	143138	468	143679	46
141668	174	141965	139	142283	342	142466	116	142553	117	142640	116	143140	468	143680	46
141669	174	141966	139	142284	342	142467	116	142554	117	142641	117	143142	468	143681	46
141670	174	141967	139	142285	342	142468	117	142555	116	142642	117	143144	468	143682	46
141671	174	141968	139	142286	342	142469	117	142556	116	142643	116	143146	468	143683	46
141672	174	141969	139	142287	342	142470	117	142557	116	142644	116	143148	468	143684	46
141673	174	141970	139	142288	342	142471	116	142558	116	142645	117	143150	466	143685	46
141674	174	141971	139	142289	342	142472	117	142559	117	142646	117	143152	466	143686	46
141675	174	141972	139	142290	342	142473	117	142560	116	142647	116	143154	466	143687	46
141676	174	141973	139	142291	342	142474	117	142561	117	142648	117	143156	466	143688	46
141677	174	142109	268	142292	342	142475	116	142562	117	142649	116	143158	466	143689	46
141678	174	142111	268	142296	342	142476	116	142563	116	142650	117	143160	466	143690	46
141679	174	142132	279	142297	342	142477	116	142564	116	142651	116	143162	466	143691	46
141680	174	142133	244	142298	342	142478	116	142565	116	142652	117	143164	466	143692	46
141681	174	142133	400	142302	342	142479	117	142566	117	142653	117	143166	466	143693	46
141682	174	142134	265	142303	342	142480	117	142567	116	142654	116	143168	466	143694	46
141683	174	142135	265	142304	342	142481	116	142568	117	142655	117	143169	466	143695	46
141684	174	142136	265	142395	116	142482	116	142569	117	142656	117	143170	466	143696	46
141685	174	142137	265	142396	116	142483	117	142570	117	142657	116	143171	466	143697	46
141686	174	142138	265	142397	117	142484	117	142571	117	142658	117	143172	466	143698	46
141687	174	142139	265	142398	116	142485	116	142572	117	142659	117	143173	466	143699	46
141688	174	142154	269	142399	117	142486	117	142573	117	142660	116	143174	466	143700	46
141689	174	142155	386	142400	117	142487	116	142574	116	142661	117	143175	466	143701	46
141690	174	142155	269	142401	116	142488	117	142575	116	142662	117	143176	466	143702	46
141691	174	142155	386	142402	116	142489	116	142576	117	142663	116	143177	466	143703	46
141692	174	142156	269	142403	1										



# Part Number Index

BradyID.com/s34

Catalog #	Pg	Catalog #	Pg	Catalog #	Pg	Catalog #	Pg	Catalog #	Pg	Catalog #	Pg	Catalog #	Pg
144660.....	44	144748.....	46	144835.....	36	144941.....	41	145056.....	45	145154.....	45	145246.....	49
144661.....	44	144749.....	46	144836.....	36	144942.....	41	145057.....	43	145155.....	45	145247.....	49
144662.....	45	144750.....	39	144837.....	36	144943.....	41	145058.....	43	145156.....	45	145248.....	49
144663.....	45	144751.....	39	144838.....	36	144944.....	41	145059.....	43	145157.....	45	145249.....	49
144664.....	45	144752.....	39	144839.....	36	144945.....	41	145060.....	43	145158.....	45	145250.....	47
144665.....	45	144753.....	39	144840.....	36	144946.....	41	145061.....	43	145159.....	45	145251.....	47
144666.....	45	144754.....	39	144841.....	36	144947.....	41	145062.....	43	145160.....	49	145252.....	47
144667.....	45	144755.....	39	144842.....	36	144948.....	41	145063.....	43	145161.....	49	145253.....	47
144668.....	45	144756.....	39	144843.....	36	144949.....	36	145064.....	43	145162.....	49	145254.....	47
144669.....	44	144757.....	39	144844.....	36	144950.....	36	145065.....	43	145163.....	49	145255.....	47
144670.....	44	144758.....	39	144845.....	36	144951.....	36	145066.....	43	145164.....	49	145256.....	47
144671.....	44	144759.....	39	144847.....	40	144952.....	36	145067.....	43	145165.....	49	145257.....	47
144672.....	44	144760.....	39	144850.....	40	144953.....	36	145068.....	43	145166.....	49	145258.....	47
144674.....	44	144761.....	39	144851.....	40	144954.....	36	145069.....	43	145167.....	45	145259.....	47
144675.....	44	144762.....	39	144852.....	40	144955.....	48	145070.....	37	145168.....	45	145260.....	47
144676.....	49	144763.....	39	144853.....	40	144956.....	48	145071.....	37	145169.....	45	145261.....	47
144677.....	49	144764.....	39	144854.....	40	144957.....	48	145072.....	37	145170.....	45	145262.....	39
144678.....	49	144765.....	39	144855.....	40	144958.....	48	145073.....	37	145171.....	45	145263.....	39
144679.....	49	144766.....	39	144856.....	40	144959.....	48	145074.....	37	145172.....	45	145264.....	39
144680.....	49	144767.....	39	144857.....	40	144960.....	48	145075.....	37	145173.....	45	145265.....	39
144681.....	49	144768.....	39	144858.....	36	144961.....	41	145076.....	43	145174.....	45	145266.....	39
144682.....	46	144769.....	39	144859.....	36	144963.....	41	145077.....	43	145175.....	45	145267.....	39
144683.....	46	144770.....	39	144860.....	36	144964.....	41	145078.....	43	145176.....	45	145268.....	47
144684.....	46	144771.....	39	144861.....	36	144965.....	41	145080.....	43	145177.....	45	145269.....	47
144685.....	46	144772.....	39	144862.....	36	144966.....	41	145081.....	43	145178.....	45	145270.....	47
144686.....	46	144773.....	39	144863.....	36	144967.....	41	145083.....	43	145179.....	45	145271.....	47
144687.....	46	144774.....	39	144864.....	40	144968.....	41	145084.....	43	145181.....	45	145272.....	47
144688.....	46	144775.....	39	144865.....	40	144969.....	41	145085.....	43	145182.....	45	145273.....	47
144689.....	46	144776.....	39	144866.....	40	144971.....	41	145086.....	43	145183.....	45	145274.....	39
144690.....	46	144777.....	39	144867.....	40	144972.....	41	145087.....	43	145184.....	45	145275.....	39
144691.....	46	144778.....	39	144868.....	40	144973.....	41	145088.....	43	145185.....	45	145276.....	39
144692.....	46	144779.....	39	144869.....	40	144974.....	41	145091.....	43	145186.....	45	145277.....	39
144693.....	46	144780.....	39	144870.....	40	144975.....	41	145093.....	43	145187.....	45	145278.....	39
144694.....	46	144781.....	39	144871.....	40	144976.....	41	145095.....	43	145188.....	45	145279.....	39
144695.....	46	144782.....	39	144872.....	40	144977.....	41	145096.....	43	145189.....	45	145280.....	47
144696.....	46	144783.....	39	144873.....	40	144978.....	41	145097.....	49	145190.....	45	145281.....	47
144697.....	46	144784.....	39	144874.....	40	144979.....	41	145098.....	49	145191.....	45	145282.....	47
144698.....	46	144785.....	39	144875.....	40	144980.....	41	145099.....	49	145192.....	45	145283.....	47
144699.....	46	144786.....	39	144876.....	40	144981.....	42	145100.....	49	145193.....	45	145284.....	47
144700.....	47	144787.....	39	144877.....	41	144982.....	42	145101.....	49	145194.....	45	145285.....	47
144701.....	47	144788.....	39	144878.....	41	144983.....	42	145102.....	49	145195.....	45	145286.....	39
144702.....	47	144789.....	39	144879.....	41	144984.....	42	145103.....	43	145196.....	45	145287.....	39
144703.....	47	144790.....	39	144880.....	41	144985.....	42	145104.....	43	145197.....	45	145288.....	39
144705.....	47	144791.....	36	144881.....	41	144986.....	42	145107.....	43	145198.....	38	145289.....	39
144706.....	47	144792.....	36	144882.....	41	144987.....	42	145108.....	43	145199.....	38	145290.....	39
144707.....	47	144793.....	36	144883.....	41	144988.....	37	145109.....	43	145200.....	38	145291.....	39
144708.....	47	144794.....	36	144884.....	41	144989.....	43	145110.....	43	145201.....	38	145438.....	173
144709.....	47	144795.....	36	144885.....	41	144990.....	37	145111.....	43	145202.....	38	145439.....	173
144710.....	47	144796.....	36	144886.....	41	144991.....	37	145112.....	43	145203.....	38	145440.....	173
144711.....	47	144797.....	40	144887.....	41	144992.....	37	145113.....	43	145204.....	38	145441.....	173
144712.....	37	144798.....	40	144888.....	41	144993.....	37	145114.....	43	145205.....	46	145442.....	173
144713.....	37	144799.....	40	144889.....	41	144994.....	43	145115.....	37	145206.....	46	145443.....	173
144714.....	37	144800.....	40	144890.....	41	144995.....	43	145116.....	37	145207.....	46	145549.....	475
144715.....	37	144801.....	40	144891.....	41	144996.....	43	145117.....	37	145208.....	46	145550.....	475
144716.....	37	144802.....	40	144892.....	36	144997.....	43	145118.....	37	145209.....	46	145551.....	475
144717.....	37	144803.....	40	144893.....	36	144998.....	43	145119.....	37	145210.....	46	145552.....	475
144718.....	38	144804.....	40	144894.....	36	144999.....	43	145120.....	37	145211.....	46	145553.....	475
144719.....	38	144805.....	40	144895.....	36	145000.....	43	145122.....	37	145212.....	46	145554.....	475
144720.....	38	144806.....	40	144896.....	36	145014.....	43	145123.....	37	145213.....	46	145579.....	472
144721.....	38	144807.....	40	144897.....	36	145015.....	43	145124.....	37	145214.....	46	145580.....	472
144722.....	38	144808.....	40	144898.....	36	145016.....	43	145125.....	37	145215.....	46	145586.....	273
144723.....	38	144809.....	40	144899.....	41	145017.....	43	145126.....	37	145216.....	46	236919.....	473
144724.....	38	144810.....	40	144900.....	41	145018.....	43	145127.....	37	145217.....	46	833918.....	489
144725.....	38	144811.....	40	144912.....	41	145019.....	43	145129.....	43	145218.....	46	871239.....	473
144726.....	38	144812.....	40	144913.....	41	145020.....	43	145130.....	43	145219.....	39	873367.....	486
144727.....	38	144813.....	40	144914.....	41	145022.....	43	145131.....	43	145220.....	39	AW124.....	418
144728.....	38	144814.....	40	144915.....	41	145024.....	43	145132.....	43	145221.....	39	AW1818.....	419
144729.....	38	144815.....	36	144916.....	41	145025.....	43	145133.....	43	145222.....	39	AW1818-2.....	419
144730.....	46	144816.....	36	144917.....	41	145026.....	43	145136.....	43	145223.....	39	AW412.....	418
144731.....	46	144817.....	36	144918.....	36	145031.....	43	145137.....	43	145224.....	39	AW430.....	418
144732.....	46	144818.....	36	144919.....	36	145032.....	43	145138.....	43	145225.....	46	AW806.....	418
144733.....	46	144819.....	36	144920.....	36	145034.....	43	145139.....	43	145227.....	46	AW99.....	419
144734.....	46	144820.....	36	144921.....	36	145035.....	43	145140.....	44	145228.....	46	B30-17-438.....	369
144735.....	46	144821.....	40	144922.....	36	145036.....	43	145141.....	44	145229.....	46	B30-18-438.....	369
144736.....	46	144822.....	40	144923.....	36	145037.....	43	145142.....	44	145230.....	46	B30-25-595-ANSICA.....	360
144737.....	46	144823.....	40	144924.....	41	145038.....	43	145143.....	44	145231.....	46	B30-25-595-ANSIDA.....	360
144738.....	46	144824.....	40	144925.....	41	145040.....	43	145144.....	44	145233.....	46	B30-25-595-ANSINO.....	360
144739.....	46	144825.....	40	144926.....	41	145041.....	43	145145.....	44	145234.....	46	B30-25-595-ANSIWA.....	360
144740.....	46	144826.....	40	144927.....	41	145042.....	43	145146.....	44	145238.....	39	B30-25-595-BLNKWT.....	360
144741.....	46	144827.....	40	144928.....	41	145045.....	43	145147.....	44	145239.....	39	B30-25-595-BLNKYL.....	360
144742.....	46	144828.....	40	144929.....	41	145046.....	43	145148.....	44	145240.....	44	B30-25-595-OSHACA.....	360
144743.....	46	144829.....	40	144936.....	41	145050.....	43	145149.....	44	145241.....	39	B30-25-595-OSHADA.....	360
144744.....	46	144830.....	40	144937.....	41	145051.....	43	145150.....	44	145242.....	39	B30-219-595-BLNKWT.....	360
144745.....	46	144832.....	40	144938.....	41	145053.....	43	145151.....	44	145243.....	39	B30-161-595-DIAM.....	364
144746.....	46	144833.....	36	144939.....	41	145054.....	43	145152.....	44	145244.....	49	B30-222-438.....	369
144747.....	46	144834.....	36	144940.....	41	145055.....	45	145153.....	45	145245.....	49	B30-241-595-ANSICA.....	360

Part Number Index

# Part Number Index

BradyID.com/s34

Catalog #	Pg	Catalog #	Pg	Catalog #	Pg	Catalog #	Pg	Catalog #	Pg	Catalog #	Pg	Catalog #	Pg
B30-241-595-ANSIDA	360	B30C-500-595-WT	368	B30C-3000-595-WT	358	B30EP-172-593-YL	366	B33-14-717	370	B33-55-424	364	B33-250-2-342YL	374
B30-241-595-ANSINO	360	B30C-500-595-YL	368	B30C-3000-595-YL	358	B30EP-173-593-BK	366	B33-14-718	370	B33-55-434	369	B33-250-2-7642	376
B30-241-595-ANSIWA	360	B30C-500-595-YL	368	B30C-3250-551-WT	358	B30EP-173-593-GN	366	B33-14-724	370	B33-55-435	369	B33-272-427	372
B30-241-595-BLNKWT	360	B30C-1125-595-WT	358	B30C-4000-526	362	B30EP-173-593-RD	366	B33-14-727	370	B33-55-483	367	B33-273-427	372
B30-241-595-BLNKYL	360	B30C-1125-595-WT	358	B30C-4000-549-WT	364	B30EP-173-593-SL	366	B33-17-422	368	B33-55-483	368	B33-375-2-342	374
B30-241-595-OSHACA	360	B30C-1125-595-YL	368	B30C-4000-549-YL	364	B30EP-173-593-WT	366	B33-17-423	368	B33-56-427	372	B33-375-2-342-2	374
B30-241-595-OSHADA	360	B30C-1125-595-YL	368	B30C-4000-569-BK	359	B30EP-173-593-YL	366	B33-17-424	364	B33-58-727	370	B33-375-2-342YL	374
B30-242-595-BLNKWT	360	B30C-1125-526	362	B30C-4000-569-BL	359	B30EP-174-593-BK	366	B33-17-425	363	B33-59-486	369	B33-375-2-7642	376
B30-244-595-CB	364	B30C-1125-549-WT	364	B30C-4000-569-BR	359	B30EP-174-593-GN	366	B33-17-428	369	B33-59-727	370	B33-500-2-342	374
B30-244-595-DIAM	364	B30C-1125-549-YL	364	B30C-4000-569-CL	359	B30EP-174-593-RD	366	B33-17-430	368	B33-68-498	367	B33-500-2-342-2	374
B30-244-595-HMIG	364	B30C-1125-569-BK	359	B30C-4000-569-GN	359	B30EP-174-593-SL	366	B33-17-432	368	B33-68-498	367	B33-500-2-342YL	374
B30-244-595-NFPA	364	B30C-1125-569-BL	359	B30C-4000-569-GY	359	B30EP-174-593-WT	366	B33-17-434	369	B33-68-499	367	B33-500-2-342YL-2	374
B30-245-595-CB	364	B30C-1125-569-BR	359	B30C-4000-569-LB	359	B30EP-174-593-YL	366	B33-17-435	367	B33-72-723	368	B33-500-2-7642	376
B30-245-595-NFPA	364	B30C-1125-569-CL	359	B30C-4000-569-OC	359	B30EP-175-593-BK	366	B33-17-483	368	B33-72-718	370	B33-750-2-342	374
B30-246-595-HMIG	364	B30C-1125-569-GN	359	B30C-4000-569-OR	359	B30EP-175-593-GN	366	B33-17-484	367	B33-72-727	370	B33-750-2-342-2	374
B30-246-595-NFR	364	B30C-1125-569-GY	359	B30C-4000-569-PK	359	B30EP-175-593-WT	366	B33-17-484	368	B33-73-427	372	B33-750-2-342YL	374
B30-255-551-ANSICA	360	B30C-1125-569-LB	359	B30C-4000-569-PL	359	B30EP-175-593-YL	366	B33-17-486	369	B33-74-427	372	B33-750-2-342-YL-2	374
B30-255-551-ANSIDA	360	B30C-1125-569-OC	359	B30C-4000-569-RD	359	B30EP-176-593-BK	366	B33-17-489	368	B33-75-427	372	B33-750-2-7642	376
B30-255-551-OSHADA	360	B30C-1125-569-OR	359	B30C-4000-569-SB	359	B30EP-176-593-GN	366	B33-18-422	368	B33-76-422	368	B33-1000-2-342	374
B30-255-551-WHT	360	B30C-1125-569-PK	359	B30C-4000-569-TN	359	B30EP-176-593-WT	366	B33-18-423	368	B33-76-486	369	B33-1000-2-342-2	374
B30-260-7569-CLP1	357	B30C-1125-569-PL	359	B30C-4000-569-WT	359	B30EP-176-593-YL	366	B33-18-424	364	B33-80-427	372	B33-1000-2-342YL	374
B30-260-7569-CLP2	357	B30C-1125-569-RD	359	B30C-4000-569-YL	359	B30EP-177-593-BK	366	B33-18-425	363	B33-81-427	372	B33-1000-2-342YL-2	374
B30-260-7569-CLP3A	357	B30C-1125-569-SB	359	B30C-4000-581-WT	363	B30EP-177-593-GN	366	B33-18-428	369	B33-82-427	372	B33-1000-2-7642	376
B30-260-7569-CLP3B	357	B30C-1125-569-TN	359	B30C-4000-581-YL	363	B30EP-177-593-WT	366	B33-18-430	368	B33-87-498	367	B33-1500-2-342	374
B30-260-7569-CLP4A	357	B30C-1125-569-WT	359	B30C-4000-584-OR	362	B30EP-177-593-YL	366	B33-18-432	368	B33-87-498	371	B33-1500-2-342-2	374
B30-260-7569-CLP4B	357	B30C-1125-569-YL	359	B30C-4000-584-SL	362	B30EP-167U-593-BK	365	B33-18-434	369	B33-88-498	367	B33-1500-2-342BK	374
B30-261-7569-CLP1	357	B30C-1125-581-WT	363	B30C-4000-584-YL	362	B30EP-167U-593-GN	365	B33-18-435	369	B33-88-498	371	B33-1500-2-342YL	374
B30-261-7569-CLP2	357	B30C-1125-581-YL	363	B30C-4000-595-BK	358	B30EP-167U-593-RD	365	B33-18-484	368	B33-89-498	367	B33-1500-2-342-YL-2	374
B30-261-7569-CLP3A	357	B30C-1125-584-OR	362	B30C-4000-595-BL	358	B30EP-167U-593-WT	365	B33-18-484	368	B33-89-498	371	B33-1500-2-7642	376
B30-261-7569-CLP3B	357	B30C-1125-584-SL	362	B30C-4000-595-BR	358	B30EP-167U-593-YL	365	B33-18-483	367	B33-90-498	367	B33-2000-2-7642	376
B30-261-7569-CLP4A	357	B30C-1125-584-YL	362	B30C-4000-595-CL	358	B30KIT-ARCLASH-W	378	B33-18-483	368	B33-90-498	371	B33-240-422	372
B30-261-7569-CLP4B	357	B30C-1125-595-BK	358	B30C-4000-595-GD	358	B30KIT-GENIUN	378	B33-18-486	369	B33-91-498	371	B33C-240-498	371
B30-262-7569-CLP1	357	B30C-1125-595-BL	358	B30C-4000-595-GN	358	B30KIT-LEANVW	378	B33-18-489	368	B33-94-2-342	374	B33C-312-422	372
B30-262-7569-CLP2	357	B30C-1125-595-BR	358	B30C-4000-595-GY	358	B30KIT-PIPE	378	B33-19-422	368	B33-94-2-342-2	374	B33-312-498	371
B30-262-7569-CLP3A	357	B30C-1125-595-CL	358	B30C-4000-595-OR	358	B30KIT-SFTY	378	B33-19-423	368	B33-94-2-342YL	374	B33C-375-422	372
B30-262-7569-CLP3B	357	B30C-1125-595-GD	358	B30C-4000-595-PL	358	B31-CCT	353	B33-19-424	364	B33-94-2-342YL-2	374	B33C-375-498	374
B30-262-7569-CLP4A	357	B30C-1125-595-GN	358	B30C-4000-595-RD	358	B31-CCT	355	B33-19-425	363	B33-94-2-7642	376	B33C-1000-437	373
B30-262-7569-CLP4B	357	B30C-1125-595-GY	358	B30C-4000-595-TN	358	B31-WIPER	353	B33-19-428	369	B33-95-498	367	B33C-1000-437YL	373
B30-263-595-CB	364	B30C-1125-595-OR	358	B30C-4000-595-YL	358	B31-WIPER	355	B33-19-432	368	B33-95-498	371	B33C-1000-437YL	373
B30-263-595-NFPA	364	B30C-1125-595-PL	358	B30C-4000-854-CAUT	361	B33-1-423	368	B33-19-434	369	B33-102-422	368	B33C-1000-472YL	373
B30-R4300	379	B30C-1125-595-RD	359	B30C-4000-854-DANG	361	B33-1-437	373	B33-19-435	369	B33-103-423	368	B33C-1125-565-SL	369
B30-R4400-WT	379	B30C-1125-855-WT	361	B30C-4000-854-WARN	361	B33-1-472	373	B33-19-483	367	B33-103-717	370	B33C-1500-437	373
B30-R4500-SV	379	B30C-1125-855-YL	361	B30C-4000-854-WT	361	B33-1-498	367	B33-19-483	368	B33-103-727	370	B33C-1500-437YL	373
B30-R6000	379	B30C-2250-526	362	B30C-4000-854-YL	361	B33-1-498	371	B33-19-484	367	B33-113-427	372	B33C-1500-472	373
B30-R6200	379	B30C-2250-549-WT	364	B30C-4000-855-CAUT	361	B33-1-718	370	B33-19-484	368	B33-115-427	372	B33C-1500-472YL	373
B30-R6400	379	B30C-2250-549-YL	364	B30C-4000-855-DANG	361	B33-1-724	370	B33-19-486	369	B33-116-427	372	B33C-2000-437	373
B30-R6600	379	B30C-2250-569-BK	359	B30C-4000-855-WARN	361	B33-1-727	370	B33-19-489	368	B33-118-427	372	B33C-2000-437YL	373
B30-R6700-WT	379	B30C-2250-569-BL	359	B30C-4000-855-WT	361	B33-2-437	373	B33-20-424	364	B33-119-427	372	B33C-2000-472	373
B30-R10000	379	B30C-2250-569-BR	359	B30C-4000-855-YL	361	B33-2-472	373	B33-25-424	364	B33-120-427	372	B33C-2000-472YL	373
B30-R10000-BL	379	B30C-2250-569-CL	359	B30C-4250-509-WT	363	B33-2-719	370	B33-26-427	372	B33-121-427	372	B33C-2250-565-SL	369
B30-R10000-GN	379	B30C-2250-569-GN	359	B30C-4250-509-YL	363	B33-2-724	370	B33-27-427	372	B33-125-2-342	374	B33C-3000-428	369
B30-R10000-MA	379	B30C-2250-569-GY	359	B30C-4250-551-WT	361	B33-2-727	370	B33-29-423	368	B33-125-2-342-2	374	B33C-3000-437	373
B30-R10000-OR	379	B30C-2250-569-LB	359	B30EP-167-593-BK	365	B33-3-423	367	B33-29-437	373	B33-125-2-342YL	374	B33C-3000-437YL	373
B30-R10000-RD	379	B30C-2250-569-OC	359	B30EP-167-593-GN	365	B33-4-724	370	B33-29-437YL	373	B33-125-2-342YL-2	374	B33C-3000-472L	373
B30-R10000-WT	379	B30C-2250-569-OR	359	B30EP-167-593-OR	365	B33-5-422	368	B33-29-472	373	B33-125-484	367	B33C-3000-472YL	373
B30-R10000-YL2	379	B30C-2250-569-PK	359	B30EP-167-593-WT	365	B33-5-423	368	B33-29-472YL	373	B33-125-484	368	B33C-4000-565-SL	369
B30C-500-569-BK	359	B30C-2250-569-PL	359	B30EP-167-593-YL	365	B33-5-425	363	B33-38-423	368	B33-125-2-7642	376	B33D-94-2-342	375
B30C-500-569-BL	359	B30C-2250-569-RD	359	B30EP-168-593-BK	365	B33-5-428	368	B33-38-718	370	B33-131-427	372	B33D-94-2-342BK	375
B30C-500-569-BR	359	B30C-2250-569-SB	359	B30EP-168-593-GN	365	B33-5-430	368	B33-38-719	370	B33-135-427AW	372	B33D-94-2-342YL	375
B30C-500-569-CL	359	B30C-2250-569-TN	359	B30EP-168-593-RD	365	B33-5-432	368	B33-38-727	370	B33-136-427	368	B33D-94-2-344	377
B30C-500-569-GN	359	B30C-2250-569-WT	359	B30EP-168-593-WT	365	B33-5-434	369	B33-42-719	370	B33-136-434	369	B33D-94-2-344BK	377
B30C-500-569-GY	359	B30C-2250-569-YL	359	B30EP-168-593-YL	365	B33-5-437	373	B33-43-423	368	B33-136-484	367	B33D-94-2-344YL	377
B30C-500-569-LB	359	B30C-2250-581-WT	363	B30EP-169-593-BK	365	B33-5-437YL	373	B33-43-717	370	B33-136-484	368	B33D-94-2-345	376
B30C-500-569-OC	359	B30C-2250-581-YL	363	B30EP-169-593-GN	365	B33-5-472	373	B33-43-718	370	B33-136-499	367	B33D-94-2-345BK	376
B30C-500-569-OR	359	B30C-2250-584-OR	362	B30EP-169-593-RD	365	B33-5-472YL	373	B33-43-719	370	B33-137-427AW	372	B33D-94-2-7642	376
B30C-500-569-PL	359	B30C-2250-584-SL	362	B30EP-169-593-WT	365	B33-5-484	367	B33-43-724	370	B33-137-499	367	B33D-125-2-342	375
B30C-500-569-RD	359	B30C-2250-584-YL	362	B30EP-169-593-YL	365	B33-5-484	368	B33-43-727	370	B33-143-499	367	B33D-125-2-342BK	375
B30C-500-569-SB	359	B30C-2250-595-BK	358	B30EP-170-593-BK	365	B33-5-483	367	B33-44-727	370	B33-144-499	367	B33D-125-2-342YL	375
B30C-500-569-TN	359	B30C-2250-595-BL	358	B30EP-170-593-GN	365	B33-5-483	368	B33-45-423	368				

# Part Number Index

BradyID.com/s34

Catalog #	Pg	Catalog #	Pg	Catalog #	Pg	Catalog #	Pg	Catalog #	Pg	Catalog #	Pg		
B33D-250-2-344	377	BM71-7-423	335	BM71-375-1-WT	322	BPU100	412	FLSP	163	LK907E	449	M-49-498	299
B33D-250-2-344BK	377	BM71-11-427	319	BM71-375-175-342	334	BPU200	412	FLT-ETSH9	239	LK980E	441	M-49-498	305
B33D-250-2-344YL	377	BM71-11-427	333	BM71-375-175-WT	322	BRU500	412	FLT-ETSH9A	239	LK981E	441	M-51-427	298
B33D-250-2-345	376	BM71-11-498	318	BM71-500-1-342	334	BR801B	212	FLT-ETSI51	239	LKP	441	M-51-427	304
B33D-250-2-345BK	376	BM71-11-498	332	BM71-500-1-WT	322	BRO150	414	GD01	286	LKX	445	M-51-427	306
B33D-250-2-7642	376	BM71-11-499	311	BM71-500-1-342YL	334	BRO152	414	GD02	286	LKX-Rack	445	M-51-427-YL	298
B33D-375-2-342	375	BM71-11-499	318	BM71-500-175-342	334	BRU152	412	GD03	286	LKXSET	445	M-51-427-YL	304
B33D-375-2-342BK	375	BM71-11-499	332	BM71-500-175-342YL	334	BPTLTB-498-240	318	GD03DL	286	LKX-TKLBOX	451	M-51-427-YL	306
B33D-375-2-342YL	375	BM71-12-109	317	BM71-500-175-WT	322	BPTLTB-498-318	318	GLOBOX	473	LM023E	487	M-53-427	298
B33D-375-2-344	377	BM71-12-109	331	BM71-1000-175-342	334	BPTLTB-498-375	318	GP30	412	LMS5TDCD	300	M-53-427	304
B33D-375-2-344BK	377	BM71-16-423	312	BM71-1000-175-WT	322	BRU150	412	GP100	412	LOCB	492	M-53-427	306
B33D-375-2-344YL	377	BM71-16-423	335	BM71C-125-342	334	BS07A-BU	477	GP100-B	412	LOSBI	213	M-53-427-YL	298
B33D-375-2-345	376	BM71-17-423	312	BM71C-187-342	334	BS07A-GN	477	GP200-B	412	LOSBI1	492	M-53-427-YL	304
B33D-375-2-345BK	376	BM71-17-423	335	BM71C-240-498	331	BS07A-RD	477	GP300	412	LOSC13	488	M-53-427-YL	306
B33D-375-2-7642	376	BM71-17-427	319	BM71C-250-342	334	BS07A-YW	477	GP500	412	LOSC13 BI	488	M-60-428	297
B33D-500-2-342	375	BM71-17-427	333	BM71C-318-498	331	BS08A-BU	477	GS-10	421	LOSF5	492	M-60-428	303
B33D-500-2-342BK	375	BM71-17-428	314	BM71C-375-342	334	BS08A-GN	477	HAZ99	419	LOSP22	213	M-60-428	307
B33D-500-2-342YL	375	BM71-17-428	335	BM71C-375-498	331	BS08A-RD	477	HAZ124	418	LOSP22	492	M-60-428	307
B33D-500-2-344	377	BM71-18-427	319	BM71C-500-342	334	BS08A-YW	477	HAZ214	418	LOSP8	163	M-60-483	297
B33D-500-2-344BK	377	BM71-18-427	333	BM71C-1000-342	334	BSC20	418	HAZ218	419	LOSP8	488	M-60-483	296
B33D-500-2-344YL	377	BM71-18-498	318	BM71C-1000-582	327	BSC40	418	HAZ1818-2	419	LOSP8SP	163	M-60-483	303
B33D-500-2-345	376	BM71-18-498	332	BM71C-1000-584-OR	327	BSCSK-CB	426	HT15	412	LOSP8SP	488	M-60-483	307
B33D-500-2-345BK	376	BM71-19-423	312	BM71C-1000-584-WT	327	BSM100	417	HT30	412	LR008E	471	M-60-483	308
B33D-500-2-7642	376	BM71-19-423	335	BM71C-1000-584-YL	327	BSM300	417	HT153	412	LR018E	471	M-61-483	303
B33D-750-2-342	375	BM71-19-427	319	BM71C-1000-854-OR	327	BSM3650	417	HT200	412	LR060E	471	M-61-483	306
B33D-750-2-342BK	375	BM71-19-427	333	BM71C-1000-854-YL	326	CABLE	475	HT215	412	LR360E	471	M-61-483	307
B33D-750-2-342YL	375	BM71-19-498	318	BM71C-1000-855-WT	326	CABLE-10FT	475	HT230	412	M-7-422	299	M-61-483	307
B33D-750-2-344	377	BM71-19-498	332	BM71C-1000-855-YL	326	CABLO	475	HT303	412	M-7-422	297	M-84-499	297
B33D-750-2-344BK	377	BM71-20-422	313	BM71C-2000-582	327	CABLO-10	475	HT303X	412	M-7-422	296	M-84-499	296
B33D-750-2-344YL	377	BM71-20-422	330	BM71C-2000-584-OR	327	CB305	420	HT350	412	M-7-422	303	M-84-499	303
B33D-750-2-345	376	BM71-20-423	312	BM71C-2000-584-WT	327	CB812	420	HT500	412	M-7-422	306	M-84-499	307
B33D-750-2-345BK	376	BM71-20-423	335	BM71C-2000-584-YL	327	CC400V	418	HT550	412	M-7-422	306	M-89-422	299
B33D-750-2-7642	376	BM71-20-424	315	BM71C-2000-854-CAU	326	CC440V	418	HT555	412	M-7-422	307	M-89-422	297
B33D-1000-2-342	375	BM71-20-424	328	BM71C-2000-854-DAN	326	CH15P	416	HTBB15	417	M-7-422	308	M-89-422	296
B33D-1000-2-342BK	375	BM71-20-428	314	BM71C-2000-854-WAR	326	CH30DP	416	HTBB30	417	M-7-498	299	M-89-422	303
B33D-1000-2-342YL	375	BM71-20-428	335	BM71C-2000-854-WT	326	CH100	416	HTBB100	417	M-7-498	305	M-89-422	306
B33D-1000-2-344	377	BM71-21-427	319	BM71C-2000-854-YL	326	CH200	416	IC326E	211	M-11-427	298	M-89-422	307
B33D-1000-2-344BK	377	BM71-21-427	333	BM71C-2000-855-CAU	326	CH303	416	IDPRO-BC	344	M-11-427	304	M-89-422	307
B33D-1000-2-344YL	377	BM71-23-427	319	BM71C-2000-855-DAN	326	CH1212	416	IDPRO-BP	344	M-11-498	299	M-89-427	298
B33D-1000-2-345	376	BM71-23-427	333	BM71C-2000-855-WAR	326	CH1212-50	416	IDPRO-HC	344	M-11-498	305	M-89-427	304
B33D-1000-2-345BK	376	BM71-29-423	312	BM71C-2000-855-WT	326	CHBB15	417	JS1	212	M-11-499	297	M-89-427	306
B33D-1000-2-7642	376	BM71-29-423	335	BM71C-2000-855-YL	326	CHBB30	417	K226A	456	M-11-499	296	M-90-422	296
B33D-1500-2-342	375	BM71-29-427	319	BMP-UBP	300	CHBB100	417	LOAE01A	113	M-11-499	303	M-90-422	297
B33D-1500-2-342BK	375	BM71-29-427	333	BMP-UBP-AC	300	CL-105-619	345	LOEWO3A	113	M-11-499	307	M-90-422	299
B33D-1500-2-342YL	375	BM71-29-498	318	BMP21-MAGNET	290	CL-111-502	345	LOFE15A	114	M-12-109	305	M-90-422	303
B33D-1500-2-344	377	BM71-29-498	332	BMP21-PLUS	290	CL-111-619	345	LOFEG1G	114	M-17-351	308	M-90-422	306
B33D-1500-2-344BK	377	BM71-30-427	319	BMP21-PLUS-BATT	290	CL-111-969	345	LOFL15A	113	M-20-351	308	M-90-422	307
B33D-1500-2-344YL	377	BM71-30-427	333	BMP21-PLUS-HC	290	CL-117-619	345	LOME02A	114	M-29-428	303	M-90-422	308
B33D-1500-2-345	376	BM71-31-427	319	BMP21-PLUS-KIT1	290	CL-311-502	345	LOM303A	115	M-29-428	307	M-90-427	298
B33D-1500-2-345BK	376	BM71-31-427	333	BMP21-PLUS-KIT2	290	CL-311-619	345	L0PH02A	115	M-29-428	308	M-90-427	304
B33D-1500-2-7642	376	BM71-32-427	319	BMP41	294	CL-311-969	345	LOSR03A	115	M-30-428	303	M-90-427	306
B33D-2000-2-7642	376	BM71-32-427	333	BMP41-AC	294	CL-317-619	345	LOSS03A	115	M-30-428	308	M-91-427	298
B85-DC	391	BM71-33-427	319	BMP41-BATT	294	CL-517-619	345	LOSWG4G	115	M-32-427	304	M-91-427	304
STYLUS-3PK	391	BM71-33-427	333	BMP41-HC	294	CL-917-619	345	L0TS024A	115	M-32-427	306	M-91-427	306
BBP31	353	BM71-34-427	319	BMP41-KIT-EL	294	CLT2	463	L0W002A	115	M-33-427	304	M-91-427-YL	298
BBP31-ARCFASH-KIT	353	BM71-34-427	333	BMP41-KIT-EL	295	CLT4	463	L3FE15A	113	M-33-427	306	M-91-427-YL	304
BBP31-ARCFASH-KIT	378	BM71-40-412	317	BMP41-KIT-GI	294	CS-CB18	421	LADXPRT-SER-USB	338	M-34-427	304	M-91-427-YL	306
BBP31-GENIND-KIT	353	BM71-40-412	330	BMP41-KIT-GI	295	CS-LFB10	421	LAD-EITH/L12	238	M-34-427	306	M-91-498	299
BBP31-GENIND-KIT	378	BM71-64-427	319	BMP41-KIT-VD	294	CSP	163	LAD-EITH12	238	M-47-422	299	M-91-498	305
BBP31-LEANVW-KIT	353	BM71-64-427	333	BMP41-KIT-VD	295	DGUARD9	422	LAD-EITL521	238	M-47-422	297	M-92-428-BB	297
BBP31-LEANVW-KIT	378	BM71-094-1-WT	322	BMP41-MAGNET	294	DGUARD14	422	LOC202E	456	M-47-422	296	M-92-428-BB	303
BBP31-MWL	353	BM71-094-175-WT	322	BMP41-QC	294	DGUARD910	422	LC203G	456	M-47-422	303	M-92-428-BB	308
BBP31-MWS	353	BM71-94-175-342YL	334	BMP41-USB	294	DGUARD1410	422	LC210G	457	M-47-422	306	M-102-427	298
BBP31-PIPE-KIT	353	BM71-107-427	319	BMP51	300	DPA24	422	LC211G	457	M-47-422	307	M-102-427	304
BBP31-PIPE-KIT	378	BM71-107-427	333	BMP51-KIT-AC	300	DPE	286	LC226A	456	M-47-422	308	M-102-427	306
BBP31-SFTY-KIT	353	BM71-109-427	319	BMP51-KIT-EL	309	DTA25	419	LC251M	452	M-47-422	298	M-111-145FR-GY	305
BBP31-SFTY-KIT	378	BM71-109-427	333	BMP51-KIT-GI	309	DT025	419	LC252M	452	M-47-427	304	M-115-427	304
BBP33-C	355	BM71-110-145-GY	331	BMP51-KIT-LMK	300	DZ-100	421	LC254M	452	M-47-428	297	M-115-427	306
BBP33-C-LMP	355	BM71-111-145-GY	331	BMP51-KIT-LS	309	EHMVSD	284	LC501E	456	M-47-428	303	M-116-427	304
BBP33-C-LMP-MWS	355	BM71-125-1-342	334	BMP51-KIT-VD	309	ENT-ETSH157	239	LC502E	456	M-47-428	307	M-116-427	306
BBP33-C-MWS	355	BM71-125-1-WT	322	BMP53	300	ENT-ETSH157A	239	LC517E	455	M-47-483	296	M-125-1-342	304
BBP85	391	BM71-125-175-342	334	BMP53-KIT-AC-BP	300	ENT-ETSI532	239	LC518E	455	M-47-483	307	M-125-075-342	298
BBP85-31-71-KIT	391	BM71-125-175-342YL	334	BMP53-KIT-EL	309	ENV50	414	LC744E	456	M-47-483	307	M-125-075-342	304
BBP85-31-KIT	391	BM71-125-175-WT	322	BMP53-KIT-GI	309	ENV100	414	LCDOI3P	284	M-47-483	303	M-128-499	297
BBP85-71-KIT	391	BM71-187-1-342	334	BMP53-KIT-LMK	300	ENV150	414	M-48-427	298	M-48-427	298	M-128-499	296
BBP85-MWL	391	BM71-187-1-342YL	334	BMP53-KIT-LS	309	ENV200	414	M-48-427	304	M-48-427	304	M-128-499	303
BCK	213	BM71-187-1-WT	322	BMP53-KIT-VD	309	ENV300	414	M-48-498	299	M-48-498	299	M-128-499	307
BH2010	213	BM71-187-175-WT	322	BMP71	309	ENV500	414	M-48-498	305	M-48-498	305	M-130-499	297
BH2023	213	BM71-187-175-342	334	BMP71-LM	324	ENV510	420	M-49-422	297	M-49-422	297	M-130-499	296
BLSP	163	BM71-187-175-342YL	334	BMP71-MW	324	ENV810</							



# Part Number Index

[BradyID.com/s34](http://BradyID.com/s34)

Catalog #	Pg	Catalog #	Pg	Catalog #	Pg	Catalog #	Pg	Catalog #	Pg	Catalog #	Pg	Catalog #	Pg
M-136-427	304	M21-750-595-YL	291	M71-20-486	328	M71-45-422	330	M71-R4400-WT	337	M71C-1900-499	332	MC-375-422	297
M-141-499	298	M21-1000-427	292	M71-21-427	333	M71-45-430	328	M71-R6000	337	M71C-2000-472	332	MC-375-422	296
M-141-499	305	M21-1250-427	292	M71-21-427-YL	333	M71-61-483	328	M71-R6200	337	M71C-2000-472-YL	332	MC-375-422	306
M-143-427	298	M21-1500-427	292	M71-21-472	332	M71-64-427	333	M71-R6400	337	M71C-2000-530	336	MC-375-422	306
M-143-427	304	M50-BATT-TRAY	300	M71-21-498	332	M71-65-483	328	M71-R6600	337	M71C-2000-581-WT	327	MC-375-422	303
M-143-427	306	M50-CABLE	300	M71-21-499	332	M71-66-427	333	M71-R6800-WT	337	M71C-2000-581-YL	327	MC-375-422	308
M-152-499	305	M50-HC	300	M71-21-642	333	M71-68-430	328	M71-R6900-BL	337	M71C-2000-595-BK	325	MC-375-498	299
M-163-498	299	M50-MAGNET	300	M71-22-423	335	M71-71-430	328	M71-R6900-GN	337	M71C-2000-595-BL	325	MC-375-498	303
M-163-498	305	M50-SC	300	M71-22-428	335	M71-78-499	332	M71-R6900-MA	337	M71C-2000-595-BR	325	MC-375-499	297
M-187-1-342	304	M420	286	M71-23-423	335	M71-80-488	328	M71-R6900-RD	337	M71C-2000-595-CL	325	MC-375-499	296
M-187-075-342	298	M71-1-423	335	M71-23-427	333	M71-81-488	328	M71-R6900-YL	337	M71C-2000-595-GD	325	MC-475-412	299
M-187-075-342	298	M71-2-423	335	M71-23-483	328	M71-88-427	333	M71-SC	324	M71C-2000-595-GN	325	MC-475-412	306
M-250-1-342	304	M71-2-717	336	M71-24-423-BK	335	M71-94-1-342	334	M71C-230-412	330	M71C-2000-595-GY	325	MC-475-412	306
M-250-075-342	298	M71-3-423	335	M71-25-423	335	M71-94-1-342YL	334	M71C-240-498	331	M71C-2000-595-LB	325	MC-475-422	299
M-250-075-342	298	M71-3-727	335	M71-25-718	336	M71-94-175-342	334	M71C-318-498	331	M71C-2000-595-OC	325	MC-475-422	303
M-375-1-342	304	M71-4-423	335	M71-26-423	335	M71-94-175-342YL	334	M71C-375-412	330	M71C-2000-595-OR	325	MC-475-422	297
M-375-075-342	298	M71-4-718	336	M71-26-428	335	M71-96-427	333	M71C-375-422	330	M71C-2000-595-PK	325	MC-475-422	296
M-375-075-342	298	M71-5-423	335	M71-27-423	335	M71-97-488	328	M71C-375-430	328	M71C-2000-595-PL	325	MC-475-422	306
M-AC-110937	290	M71-6-423	335	M71-28-423	330	M71-103-427	333	M71C-375-498	331	M71C-2000-595-RD	325	MC-475-422	306
M-AC-143110	300	M71-6-473	336	M71-28-423	335	M71-104-427	333	M71C-475-412	330	M71C-2000-595-SB	325	MC-475-422	308
MC-1000-427	304	M71-7-423	335	M71-28-427	333	M71-107-427	333	M71C-475-422	330	M71C-2000-595-TN	325	MC-500-422	297
MC-1000-427	306	M71-7-498	332	M71-28-473	336	M71-109-427	333	M71C-500-412	330	M71C-2000-595-WT	325	MC-500-422	296
MC-1500-427	304	M71-7-499	332	M71-28-499	332	M71-110-145FR-GY	331	M71C-500-422	330	M71C-2000-595-YL	325	MC-500-422	308
MC-1500-427	306	M71-9-423	335	M71-28-724	335	M71-110-145-GY	331	M71C-500-423	330	M71EP-167-593	329	MC-500-422	303
M21-125-C-342	292	M71-9-472	332	M71-29-423	335	M71-111-145FR-GY	331	M71C-500-423	335	M71EP-167-593-BK	329	MC-500-422	307
M21-125-C-342-YL	292	M71-9-473	336	M71-29-427	333	M71-111-145-GY	331	M71C-500-430	328	M71EP-167-593-GN	329	MC-500-499	297
M21-187-C-342	292	M71-9-718	336	M71-29-428	335	M71-125-1-342	334	M71C-500-483	328	M71EP-167-593-RD	329	MC-500-499	296
M21-187-C-342-YL	292	M71-9-724	335	M71-29-459	328	M71-125-1-342YL	334	M71C-500-498	332	M71EP-167-593-YL	329	MC-500-584	296
M21-250-423	293	M71-10-423	335	M71-29-472	332	M71-125-175-342	334	M71C-500-499	332	M71EP-168-593	329	MC-500-584	303
M21-250-430	293	M71-10-427	333	M71-29-483	328	M71-125-175-342YL	334	M71C-500-530	336	M71EP-168-593-BK	329	MC-500-584-YL	296
M21-250-430-WT-CL	293	M71-10-472	332	M71-29-486	328	M71-187-1-342	334	M71C-500-581-WT	327	M71EP-168-593-RD	329	MC-500-584-YL	303
M21-250-595-WT	291	M71-10-473	336	M71-29-489	328	M71-187-1-342YL	334	M71C-500-581-YL	327	M71EP-168-593-TN	329	MC-500-595-BK-WT	295
M21-250-595-YL	291	M71-10-498	332	M71-29-498	332	M71-187-175-342	334	M71C-500-595-BK	325	M71EP-168-593-YL	329	MC-500-595-BK-WT	302
M21-250-C-342	292	M71-10-727	335	M71-29-499	332	M71-187-175-342YL	334	M71C-500-595-BL	325	M71EP-169-593	329	MC-500-595-BL-WT	295
M21-250-C-342-YL	292	M71-11-427	333	M71-30-422	330	M71-250-1-342	334	M71C-500-595-BR	325	M71EP-169-593-BK	329	MC-500-595-BL-WT	302
M21-375-423	293	M71-11-498	332	M71-30-423-TEST	327	M71-250-1-342YL	334	M71C-500-595-CL	325	M71EP-169-593-GN	329	MC-500-595-CL-BK	295
M21-375-430	293	M71-11-499	332	M71-30-427	333	M71-250-175-342	334	M71C-500-595-GD	325	M71EP-169-593-RD	329	MC-500-595-CL-BK	302
M21-375-430-WT-CL	293	M71-12-109	331	M71-30-427-AW	333	M71-250-175-342YL	334	M71C-500-595-GN	325	M71EP-169-593-YL	329	MC-500-595-CL-WT	295
M21-375-488	293	M71-13-423	335	M71-30-427-BL	333	M71-375-1-342	334	M71C-500-595-GY	325	M71EP-171-593	329	MC-500-595-CL-WT	302
M21-375-499	292	M71-13-724	335	M71-30-427-PL	333	M71-375-1-342YL	334	M71C-500-595-LB	325	M71EP-171-593-BK	329	MC-500-595-CL-WT	307
M21-375-499-TB	293	M71-14-423	335	M71-30-427-RD	333	M71-375-175-342	334	M71C-500-595-OC	325	M71EP-171-593-GN	329	MC-500-595-GN-WT	295
M21-375-595-BK	291	M71-14-717	336	M71-30-428-CALL	327	M71-375-175-342YL	334	M71C-500-595-OR	325	M71EP-171-593-RD	329	MC-500-595-GN-WT	302
M21-375-595-BL	291	M71-15-423	335	M71-30-459	332	M71-500-1-342	334	M71C-500-595-PK	325	M71EP-171-593-SL	329	MC-500-595-OR-BK	297
M21-375-595-BR	291	M71-15-428	335	M71-30-472	328	M71-500-1-342YL	334	M71C-500-595-PL	325	M71EP-171-593-YL	329	MC-500-595-OR-BK	295
M21-375-595-BL	291	M71-15-472	332	M71-30-483	328	M71-500-175-342	334	M71C-500-595-PL	325	M71EP-173-593	329	MC-500-595-OR-BK	302
M21-375-595-GN	291	M71-16-423	330	M71-30-486	332	M71-500-175-342YL	334	M71C-500-595-SB	325	M71EP-173-593-BK	329	MC-500-595-OR-BK	303
M21-375-595-GY	291	M71-16-423	335	M71-30-498	328	M71-1000-1-342	334	M71C-500-595-TN	325	M71EP-173-593-GN	329	MC-500-595-OR-BK	296
M21-375-595-OR	291	M71-16-430	328	M71-30-499	332	M71-1000-1-342YL	334	M71C-500-595-WT	325	M71EP-173-593-RD	329	MC-500-595-RD-WT	295
M21-375-595-PL	291	M71-16-473	336	M71-31-351	336	M71-1000-175-342	334	M71C-500-595-WT	330	M71EP-173-593-SL	329	MC-500-595-RD-WT	302
M21-375-595-RD	291	M71-16-483	328	M71-31-352	336	M71-1000-175-342YL	334	M71C-500-595-YL	325	M71EP-173-593-YL	329	MC-500-595-RD-WT	295
M21-375-595-WT	291	M71-16-498	332	M71-31-423	335	M71-1000-483-BK-KT	269	M71C-625-412	330	M71EP-174-593	329	MC-500-595-RD-WT	295
M21-375-595-WT	293	M71-16-499	332	M71-31-427	333	M71-1000-483-BK-KT	326	M71C-625-422	330	M71EP-174-593-BK	329	MC-500-595-RD-WT	302
M21-375-595-YL	291	M71-16-724	335	M71-31-427-GN	333	M71-1000-483-BL-KT	269	M71C-785-412	330	M71EP-174-593-GN	329	MC-500-595-RD-WT	307
M21-375-C-342-YL	292	M71-16-727	335	M71-31-427-RD	333	M71-1000-483-BL-KT	326	M71C-1000-422	330	M71EP-174-593-RD	329	MC-500-595-RD-WT	295
M21-500-423	293	M71-17-351	336	M71-31-427-YL	333	M71-1000-483-GN-KT	269	M71C-1000-430	328	M71EP-174-593-SL	329	MC-500-595-RD-WT	302
M21-500-430	293	M71-17-352	336	M71-31-472	332	M71-1000-483-GN-KT	326	M71C-1000-472	332	M71EP-174-593-YL	329	MC-500-595-CL-BK	295
M21-500-430-WT-CL	293	M71-17-423	330	M71-31-483	328	M71-1000-483-OR-KT	269	M71C-1000-472-YL	332	M71EP-176-593	329	MC-500-595-CL-BK	302
M21-500-488	293	M71-17-423	335	M71-31-498	332	M71-1000-483-OR-KT	326	M71C-1000-483	328	M71EP-176-593-BK	329	MC-500-595-CL-WT	295
M21-500-499	292	M71-17-427	333	M71-31-499	332	M71-1000-483-RD-KT	269	M71C-1000-498	332	M71EP-176-593-GN	329	MC-500-595-CL-WT	307
M21-500-499-TB	293	M71-17-428	335	M71-31-642	333	M71-1000-483-RD-KT	326	M71C-1000-499	332	M71EP-176-593-RD	329	MC-625-412	299
M21-500-595-BK	291	M71-17-430	328	M71-32-423	335	M71-1000-483-WT-KT	269	M71C-1000-530	336	M71EP-176-593-YL	329	MC-625-412	306
M21-500-595-BL	291	M71-17-472	332	M71-32-427	333	M71-1000-483-WT-KT	326	M71C-1000-581-WT	327	M71FP-1-425	331	MC-625-422	297
M21-500-595-BR	291	M71-17-473	336	M71-32-427-YL	333	M71-1000-483-YL-KT	269	M71C-1000-581-YL	327	M71FP-2-425	331	MC-625-422	296
M21-500-595-GN	291	M71-17-483	328	M71-32-489	328	M71-1000-483-YL-KT	326	M71C-1000-595-BK	325	M71FT-1-425	331	MC-625-422	306
M21-500-595-GY	291	M71-17-486	328	M71-32-498	332	M71-2000-483-BK-KT	269	M71C-1000-595-BL	325	MC11E	212	MC-750-427	298
M21-500-595-OR	291	M71-17-489	328	M71-33-427	333	M71-2000-483-BK-KT	326	M71C-1000-595-BR	325	MC-125-342	298	MC-750-427	304
M21-500-595-PL	291	M71-17-498	332	M71-33-427-YL	333	M71-2000-483-BL-KT	269	M71C-1000-595-CL	325	MC-125-342	304	MC-750-499	297
M21-500-595-RD	291	M71-17-724	335	M71-33-498	332	M71-2000-483-BL-KT	326	M71C-1000-595-GD	325	MC-125-342-YL	298	MC-750-499	296
M21-500-595-WT	291	M71-18-427	333	M71-34-427	333	M71-2000-483-GN-KT	269	M71C-1000-595-GN	325	MC-125-342-YL	304	MC-750-584	296
M21-500-595-WT	293	M71-18-498	332	M71-35-428-PROP	327	M71-2000-483-GN-KT	326	M71C-1000-595-GY	325	MC-187-342	298	MC-750-584	303
M21-500-595-YL	291	M71-18-499	332	M71-36-10									

# Part Number Index

BradyID.com/s34

Part Number Index

Catalog #	Pg	Catalog #	Pg	Catalog #	Pg	Catalog #	Pg	Catalog #	Pg	Catalog #	Pg	Catalog #	Pg
MC-750-595-RD-WT	296	MRO15-DPS	412	PLUG3	422	PTL-16-422	313	PTL-23-427-OR	321	PTL-31-483	313	PTL-43-430	312
MC-750-595-RD-WT	295	MRO15P	412	PLUG4	422	PTL-16-422	317	PTL-23-427-PL	321	PTL-31-486	314	PTL-43-432	313
MC-750-595-RD-WT	302	MRO24-DP	412	PLUG6	422	PTL-16-423	312	PTL-23-427-RD	321	PTL-31-489	313	PTL-43-439	311
MC-750-595-WT-BK	295	MRO30	412	PS125E	163	PTL-16-430	312	PTL-23-427-YL	320	PTL-31-498	318	PTL-43-439-BK	311
MC-750-595-WT-BK	302	MRO30-DP	412	PS125S	163	PTL-16-435	314	PTL-23-483	313	PTL-31-499	311	PTL-43-439-BL	311
MC-750-595-WT-BK	307	MRO30P	412	PS127E	164	PTL-16-483	313	PTL-23-498	318	PTL-31-499	318	PTL-43-439-GR	311
MC-750-595-WT-BK	307	MRO50	412	PS128E	163	PTL-16-486	314	PTL-23-499	311	PTL-31-642	319	PTL-43-439-OR	311
MC-750-595-WT-RD	295	MRO100	412	PS135E	163	PTL-16-489	313	PTL-23-499	318	PTL-31-7546	315	PTL-43-439-RD	311
MC-750-595-WT-RD	302	MRO100-2	412	PS139E	164	PTL-16-498	318	PTL-24-423-BK	312	PTL-31-7566	315	PTL-43-439-YL	311
MC-750-595-YL-BK	295	MRO150DND	412	PS139S	164	PTL-16-499	311	PTL-24-428-BK	314	PTL-31-7576	315	PTL-43-483	313
MC-750-595-YL-BK	302	MRO300	412	PSPT-094-1-*	322	PTL-16-499	318	PTL-24-483-BK	317	PTL-32-422	313	PTL-43-489	313
MC-750-595-YL-BK	307	MRO315P	412	PSPT-094-1-WT	322	PTL-17-351	315	PTL-24-486-BK	314	PTL-32-423	312	PTL-44-422	313
MC-750-595-YL-BK	307	MRO350	412	PSPT-094-175-*	322	PTL-17-422	313	PTL-25-423	312	PTL-32-427	319	PTL-44-430	312
MC-1000-584	303	MRO350-DP	412	PSPT-094-175-WT	322	PTL-17-422	317	PTL-26-423	312	PTL-32-427	319	PTL-45-422	313
MC-1000-584-YL	303	MS-50	418	PSPT-125-1-*	322	PTL-17-423	312	PTL-26-428	314	PTL-34-427	319	PTL-45-430	312
MC-1250-427	304	MS-124	418	PSPT-125-1-WT	322	PTL-17-427	319	PTL-27-423	312	PTL-34-498	318	PTL-46-430	312
MC-1500-584	303	MS-412	418	PSPT-125-175-*	322	PTL-17-427-YL	320	PTL-28-423	312	PTL-37-423	312	PTL-55-412	317
MC-1500-584-YL	303	MS-806	418	PSPT-125-175-WT	322	PTL-17-428	314	PTL-28-427	319	PTL-37-483-WARNING	317	PTL-56-412	317
MC-1500-595-BK-WT	302	MSSP	164	PSPT-187-1-*	322	PTL-17-430	312	PTL-28-427-BL	320	PTL-38-423	312	PTL-57-412	317
MC-1500-595-BL-WT	302	MUL-EITHUSA01	239	PSPT-187-1-WT	322	PTL-17-432	313	PTL-28-427-BR	320	PTL-38-483-WARNING	317	PTL-58-412	317
MC-1500-595-BL-WT	307	MUL-EITHUSA01A	239	PSPT-187-175-*	322	PTL-17-435	314	PTL-28-427-GR	321	PTL-46-422	313	PTL-59-412	317
MC-1500-595-CL-BK	302	MUL-EITL230	239	PSPT-187-175-WT	322	PTL-17-483	313	PTL-28-427-GY	320	PTL-46-422	317	PTL-61-483	313
MC-1500-595-CL-BK	307	MUL-EITL535	239	PSPT-250-1-*	322	PTL-17-486	314	PTL-28-427-OR	321	PTL-32-427-BL	320	PTL-62-483	317
MC-1500-595-CL-WT	307	MVSD	284	PSPT-250-1-WT	322	PTL-17-489	313	PTL-28-427-PL	321	PTL-32-427-BR	320	PTL-63-483	317
MC-1500-595-CL-WT	307	MVSDL	284	PSPT-250-175-*	322	PTL-17-489	318	PTL-28-427-RD	321	PTL-32-427-GR	321	PTL-64-427	319
MC-1500-595-CL-WT	307	MVSDG	284	PSPT-250-175-WT	322	PTL-17-7546	315	PTL-28-427-YL	320	PTL-32-427-GY	320	PTL-65-483	313
MC-1500-595-GN-WT	302	MVSDM	284	PSPT-375-1-*	322	PTL-17-7566	315	PTL-28-430	312	PTL-32-427-OR	321	PTL-66-427	319
MC-1500-595-GN-WT	307	MVSDM	284	PSPT-375-1-WT	322	PTL-17-7576	315	PTL-28-498	318	PTL-32-427-PL	321	PTL-74-427	319
MC-1500-595-OR-BK	302	MW-13	422	PSPT-375-175-*	322	PTL-18-427	319	PTL-28-499	311	PTL-32-427-RD	321	PTL-75-427	319
MC-1500-595-OR-BK	307	MXO1000	414	PSPT-375-175-WT	322	PTL-18-427-YL	320	PTL-28-499	318	PTL-32-427-YL	320	PTL-77-461	319
MC-1500-595-RD-WT	302	MXP-C20	425	PSPT-500-1-*	322	PTL-18-498	318	PTL-29-422	313	PTL-32-435	314	PTL-78-427-AW	319
MC-1500-595-RD-WT	307	MXP-020	425	PSPT-500-1-WT	322	PTL-18-499	311	PTL-29-423	313	PTL-32-483	313	PTL-78-488	313
MC-1500-595-WT-BK	302	MXU-020	425	PSPT-500-175-*	322	PTL-18-499	318	PTL-29-427	319	PTL-32-486	314	PTL-78-499	311
MC-1500-595-WT-BK	307	MXU1000	412	PSPT-500-175-WT	322	PTL-19-422	313	PTL-29-427-BL	320	PTL-32-489	313	PTL-78-499	318
MC-1500-595-WT-BK	307	ODN08	420	PSPT-1000-1-*	322	PTL-19-423	312	PTL-29-427-BR	320	PTL-32-498	318	PTL-80-424	315
MC-1500-595-YL-BK	302	OIL99	419	PSPT-1000-1-WT	322	PTL-19-427	319	PTL-29-427-GR	321	PTL-33-427-BL	320	PTL-80-488	313
MC-1500-595-WT-BK	307	OIL124	418	PSPT-1000-175-*	322	PTL-19-427-BL	320	PTL-29-427-GY	320	PTL-33-427-BR	320	PTL-81-488	313
MC-1500-595-WT-RD	302	OIL412	418	PSPT-1000-175-WT	322	PTL-19-427-BR	320	PTL-29-427-OR	321	PTL-33-427-GR	321	PTL-81-499	311
MC-1500-595-WT-RD	307	OIL430	419	PTL-1-423	312	PTL-19-427-GR	321	PTL-29-427-PL	321	PTL-33-427-GY	320	PTL-81-499	318
MC-1500-595-YL-BK	302	OIL806	418	PTL-2-423	312	PTL-19-427-GY	320	PTL-29-427-RD	321	PTL-33-427-OR	321	PTL-84-499	311
MC-1500-595-YL-BK	307	OIL1818	419	PTL-3-423	312	PTL-19-427-OR	321	PTL-29-427-YL	320	PTL-33-427-PL	321	PTL-84-499	318
MC-1500-595-YL-BK	307	OIL1818-2	419	PTL-4-423	312	PTL-19-427-PL	321	PTL-29-428	314	PTL-33-427-RD	321	PTL-87-427	319
MC1-1000-422	296	ON030	420	PTL-5-422	313	PTL-19-427-RD	321	PTL-29-430	312	PTL-33-427-YL	320	PTL-87-499	311
MC1-1000-422	297	OP15	414	PTL-6-423	312	PTL-19-427-YL	320	PTL-29-435	314	PTL-33-498	318	PTL-88-427	319
MC1-1000-422	303	OP15-DP	414	PTL-6-423	312	PTL-19-483	313	PTL-29-483	313	PTL-34-427-BL	320	PTL-96-427	319
MC1-1000-422	307	OP15-DPS	414	PTL-6-430	312	PTL-19-486	314	PTL-29-486	314	PTL-34-427-BR	320	PTL-97-488	313
MC1-1000-422	308	OP15P	414	PTL-7-422	313	PTL-19-489	313	PTL-29-489	313	PTL-34-427-GR	321	PTL-100-483	313
MC1-1000-595-BK-WT	295	OP30	414	PTL-7-422	317	PTL-19-498	318	PTL-29-498	311	PTL-34-427-GY	320	PTL-100-489	313
MC1-1000-595-BK-WT	302	OP30-DP	414	PTL-7-423	312	PTL-19-499	311	PTL-29-498	318	PTL-34-427-OR	321	PTL-101-483	313
MC1-1000-595-BL-WT	295	OP30P	414	PTL-7-430	312	PTL-19-499	318	PTL-29-499	311	PTL-34-427-PL	321	PTL-101-489	313
MC1-1000-595-BL-WT	302	OP50	414	PTL-7-498	318	PTL-19-642	319	PTL-29-499	318	PTL-34-427-RD	321	PTL-102-427	319
MC1-1000-595-CL-BK	295	OP100	414	PTL-7-499	311	PTL-20-351	315	PTL-30-427	319	PTL-34-427-YL	320	PTL-103-427	319
MC1-1000-595-CL-BK	302	OP150DND	414	PTL-7-499	318	PTL-20-422	313	PTL-30-422	313	PTL-35-422-PROP	313	PTL-104-427	319
MC1-1000-595-CL-WT	295	OP300	414	PTL-8-422	313	PTL-20-423	312	PTL-30-423-CALI	312	PTL-35-422-PROP	314	PTL-105-427-AW	319
MC1-1000-595-CL-WT	302	OP315P	414	PTL-8-422	317	PTL-20-424	315	PTL-30-427-AW	319	PTL-36-109	317	PTL-107-427	319
MC1-1000-595-CL-WT	307	OP350-DP	414	PTL-8-423	312	PTL-21-427	319	PTL-30-427-BL	320	PTL-37-351	315	PTL-109-427	319
MC1-1000-595-GN-WT	295	OP550	414	PTL-8-428	314	PTL-20-428	314	PTL-30-427-BR	320	PTL-37-422	313	PTL-152-427	319
MC1-1000-595-GN-WT	302	PBL2	486	PTL-8-430	312	PTL-20-435	314	PTL-30-427-GR	321	PTL-37-424	315	PTL-160-499	311
MC1-1000-595-OR-BK	297	PBL4	486	PTL-8-432	313	PTL-20-483	313	PTL-30-427-GY	320	PTL-37-428	314	PTL-161-499	311
MC1-1000-595-OR-BK	295	PBL6	486	PTL-8-439	311	PTL-20-486	314	PTL-30-427-OR	321	PTL-37-435	314	PTLEP-167-593	316
MC1-1000-595-OR-BK	302	PBL8	486	PTL-8-439-BK	311	PTL-20-489	313	PTL-30-427-PL	321	PTL-37-483	313	PTLEP-167-593-BK	316
MC1-1000-595-OR-BK	303	PCK-5	310	PTL-8-439-BL	311	PTL-20-7546	315	PTL-30-427-RD	321	PTL-37-486	314	PTLEP-167-593-GN	316
MC1-1000-595-RD-WT	296	PCK-6	338	PTL-8-439-GR	311	PTL-20-7576	315	PTL-30-427-YL	320	PTL-37-489	313	PTLEP-167-593-RD	316
MC1-1000-595-RD-WT	295	PD001E	287	PTL-8-439-OR	311	PTL-21-427-BL	320	PTL-30-428-CALI	314	PTL-37-7576	315	PTLEP-167-593-YL	316
MC1-1000-595-RD-WT	302	PD205A	287	PTL-8-439-RD	311	PTL-21-427-BR	320	PTL-30-428-INS	314	PTL-38-422	313	PTLEP-168-593	316
MC1-1000-595-WT-BK	295	PD206A	287	PTL-8-439-YL	311	PTL-21-427-GR	321	PTL-30-428-TEST	314	PTL-38-424	315	PTLEP-168-593-BK	316
MC1-1000-595-WT-BK	302	PD228E	287	PTL-8-483	313	PTL-21-427-GY	320	PTL-30-435	314	PTL-38-428	314	PTLEP-168-593-GN	316
MC1-1000-595-WT-BK	303	PD240E	286	PTL-8-489	313	PTL-21-427-OR	321	PTL-30-483	313	PTL-38-435	314	PTLEP-168-593-RD	316
MC1-1000-595-WT-BK	307	PD241E	286	PTL-9-423	312	PTL-21-427-PL	321	PTL-30-486	314	PTL-38-486	314	PTLEP-168-593-YL	316
MC1-1000-595-WT-BK	307	PD244E	285	PTL-10-423	312	PTL-21-427-RD	321	PTL-30-489	313	PTL-38-489	313	PTLEP-169-593	316
MC1-1000-595-WT-RD	295	PD256E	287	PTL-10-427	319	PTL-21-427-YL	320	PTL-30-498	318	PTL-39-422	313	PTLEP-169-593-BK	316
MC1-1000-595-WT-RD	302	PD264E	284	PTL-10-427-YL	320	PTL-21-498	312	PTL-30-499	311	PTL-39-422	317	PTLEP-169-593-GN	316
MC1-1000-595-YL-BK	295	PD265E	285	PTL-10-432	313	PTL-21-499	311	PTL-30-499	318	PTL-40-412	317	PTLEP-169-593-RD	316
MC1-1000-595-YL-BK	302	PD322E	286	PTL-10-498	318	PTL-21-499	318	PTL-30-7566	315	PTL-42-422	313	PTLEP-169-593-YL	316
MC1-1000-595-YL-BK	303	PD325E	286	PTL-11-427	319	PTL-21-642							

# Part Number Index

BradyID.com/s34

Catalog #	Pg	Catalog #	Pg	Catalog #	Pg	Catalog #	Pg	Catalog #	Pg	Catalog #	Pg
PTLEP-174-593	316	SD02M	487	SKR-PP	425	V1ME02A	114	X-84-499	338	XSL-32-427	340
PTLEP-174-593-BK	316	SF647E	493	SM681A	211	V1MS03A	115	X-103-498	340	XSL-32-427	340
PTLEP-174-593-GN	316	SH182A	164	SM682A	211	V1PH02A	115	X-130-499	338	XSL-33-427	340
PTLEP-174-593-RD	316	SIR36	417	SP818V	114	V1RR02A	115	X-132-422	338	XSL-33-427	340
PTLEP-174-593-SL	316	SIR72	417	SP184L	114	V1RR45A	115	X-162-498	340	XSL-34-427	340
PTLEP-174-593-YL	316	SIR36150	417	SPC10	420	V1SR03A	115	X-162-499	338	XSL-34-427	340
PTLEP-176-593	316	SK-CAMO	426	SPC50	414	V1SS03A	115	X-163-498	340	XSL-96-427	340
PTLEP-176-593-BK	316	SK-CAMO-RS	426	SPC100	414	V1SSG4G	115	XC-240-498	341	XSL-102-427	340
PTLEP-176-593-GN	316	SKA-20	427	SPC100B	414	V1SWG4G	115	XC-318-498	341	XSL-102-427	340
PTLEP-176-593-RD	316	SKA-20-RESCUE	427	SPC105	414	V1TOG1G	115	XC-375-422	341	XSL-103-427	340
PTLEP-176-593-YL	316	SKA20-TAA	427	SPC150	414	V1TS024A	115	XC-375-498	341	XSL-103-427	340
PTLTB-498-318	318	SKA30	427	SPC152	414	V1WH45A	115	XC-375-499	338	XSL-115-427	340
PTLTB-498-375	318	SKA30-TAA	427	SPC156	414	V1W045A	115	XC-475-422	341	XSL-115-427	340
PTPSL-17-422	313	SKA-55	428	SPC200	414	V2EX01A	113	XC-500-499	338	XSL-116-427	340
PTPSL-17-424	315	SKA55-TAA	428	SPC300	414	V2MS24A	114	XC-500-595-CL-BK	339	XSL-116-427	340
PTPSL-17-428	314	SKA-55W	428	SPC318	420	V2SS24A	115	XC-500-595-BL-WT	339		
PTPSL-20-422	313	SKA65	428	SPC500	414	V3EW03A	113	XC-500-595-GN-WT	339		
PTPSL-20-424	315	SKA65-TAA	428	SPC510	420	V3F15A	113	XC-500-595-OR-BK	339		
PTPSL-20-428	314	SKA-65W	428	SPC518	420	V2MS21A	114	XC-500-595-RD-WT	339		
PTPSL-26-422	313	SKA-95	429	SPC810	420	V5I2P	413	XC-500-595-WT-BK	339		
PTPSL-26-428	314	SKA-ATK	426	SPC818	420	V575P	413	XC-500-595-WT-RD	339		
PTPSL-50-422	313	SKA-ATK-TAA	426	SPC1900	420	VSH12P	416	XC-500-595-YL-BK	339		
PTPSL-50-428	314	SKA-BKTACID	425	SPC5510	420	VSH75P	416	XC-500-595-YL-BK	341		
PVC18	422	SKA-BKTBASE	425	SPC19150	414	VSO12P	415	XC-750-499	338		
PVC24	422	SKA-BKT-TAA	425	SPC-ACID	421	VSO75P	415	XC-750-595-BL-WT	339		
PVC36	422	SKA-CFB	426	SPC-BASE	421	WKT2	462	XC-750-595-CL-BK	339		
PVC42	422	SKA-CFB-TAA	426	SPCUN1019	416	WKT3	462	XC-750-595-GN-WT	339		
RA624150	417	SKA-PP-TAA	425	SPCUN1113	416	WML-205-292-1	344	XC-750-595-OR-BK	339		
QB0033	485	SKA-SRP	425	SPCUN1113-50	416	WML-205-292-2S	344	XC-750-595-RD-WT	339		
R4310	323	SKA-BKT	425	SPCUN1719	416	WML-205-292-75	344	XC-750-595-WT-BK	339		
R4410-BL	323	SKA-K2	427	SPCUN3800	416	WML-211-292-1	344	XC-750-595-WT-RD	339		
R4410-RD	323	SKA-LT	430	SR100	414	WML-211-292-75	344	XC-750-595-YL-BK	339		
R4410-WT	323	SKA-PP	425	SR1825	414	WML-305-292	344	XC-1000-422	341		
R5300	344	SKA-SAK	426	SR3600	414	WML-305-292-2S	344	XC-1000-499	338		
R6010	323	SKA-XLT	430	SR3625	414	WML-305-499	344	XC-1000-595-BL-WT	339		
R6210	323	SKH-20	427	SR75P	413	WML-305-502	344	XC-1000-595-CL-BK	339		
R7300	344	SKH-20-RESCUE	427	SRP100	413	WML-311-292	344	XC-1000-595-GN-WT	339		
RAG1818	417	SKH30	427	SRP200	413	WML-317-292	344	XC-1000-595-OR-BK	339		
RAG36150	417	SKH-55	428	SRPH75P	416	WML-505-499	344	XC-1000-595-RD-WT	339		
RF100	413	SKH-55W	428	SRPH100	416	WML-505-499-2S	345	XC-1000-595-WT-BK	339		
RF300	413	SKH65	428	SRPH200	416	WML-505-502	344	XC-1000-595-WT-RD	339		
RF500	413	SKH-65W	428	SRPO75P	415	WML-505-502-2S	345	XC-1000-595-YL-BK	339		
RFD300	413	SKH-95	429	SRPO100	415	WML-511-292	345	XC-1000-595-YL-BK	341		
RFD328DP	413	SKH-95W	429	SRPO200	415	WML-511-499	344	XC-1500-595-BL-WT	339		
RFRANULAR	421	SKA-95W	429	SS-2DR	422	WML-511-502	344	XC-1500-595-CL-BK	339		
RF0412	418	SKH-ATK	426	SS-4DR	422	WML-517-292	345	XC-1500-595-GN-WT	339		
RFODP100	415	SKH-BKT	425	STYLUS-3PK	381	WML-705-499	344	XC-1500-595-OR-BK	339		
RFOP14P	415	SKH-CFB	426	SW46	418	WML-705-502	344	XC-1500-595-RD-WT	339		
RFOP28DP	415	SKH-K2	427	SXT15P	414	WML-711-292	345	XC-1500-595-WT-BK	339		
RFP28-DP	413	SKH-LT	430	SXT30DP	414	WML-711-499	344	XC-1500-595-WT-RD	339		
RFP100	413	SKH-PP	425	SXT100	414	WML-711-502	344	XC-1500-595-YL-BK	339		
RFP328-DP	413	SKH-SAK	426	SXT200	414	WML-717-292	345	XC-1500-595-YL-BK	341		
RFP314P	413	SKH-SRP	425	SXT300	414	WML-905-502	344	XPRT-HC-ABC	338		
RFP500	413	SKH-XLT	430	T218	474	WML-911-499	344	XPRT-HC-KEY	338		
RFP100	413	SKMA-20	427	T220	474	WML-911-502	344	XPS-125-1	339		
RFP30P	413	SKMA-30	427	TC8	463	WMS-111-321	345	XPS-125-CONT	339		
RK018A	211	SKMA-55	428	TH2	463	WSLO	485	XPS-125-CONT-YL-BK	339		
RK085A	211	SKMA-55W	428	TLS2200	310	X-7-422	338	XPS-187-1	339		
RK623E	212	SKMA-65	429	TLS2200-AC	310	X-7-422	341	XPS-187-CONT	339		
SB-1010	422	SKMA-65W	429	TLSHM-QUICKCH	310	X-7-498	340	XPS-187-CONT-YL-BK	339		
SB-1212	422	SKMA-95	429	TLSHM-QUICKCH	342	X-11-498	340	XPS-250-1	339		
SB-1226	422	SKMA-95W	429	TLSPC	310	X-11-499	338	XPS-250-CONT	339		
SB-1236	422	SKM-LT	430	TLSPC-AC	310	X-17-422	341	XPS-250-CONT-YL-BK	339		
SB-SL44	422	SKM-XLT	430	TLSPC-BP	310	X-17-422	341	XPS-375-1	339		
SB-SL46	422	SKO-20	427	TLSPC-CABLE	310	X-17-428-SV-BK	338	XPS-375-CONT	339		
SC-4	423	SKO-20-RESCUE	427	TM19	417	X-17-483	338	XSL-11-427	340		
SC-3000	423	SKO30	427	TM29	417	X-17-483	341	XSL-17-427	340		
SC-ACC	423	SKO-55	428	TM30	417	X-18-498	340	XSL-18-427	340		
SC-Cabinet	423	SKO-55W	428	TM58	417	X-19-422	338	XSL-19-427	340		
SC-Cart	423	SKO65	428	UXT15P	412	X-19-422	341	XSL-19-427	340		
SC-D15	423	SKO-95	429	UXT100	412	X-19-498	340	XSL-21-427	340		
SC-D40	423	SKO-95W	429	UXT200	412	X-20-428-SV-BK	338	XSL-21-427	340		
SC-DP2	422	SKO-ATK	426	UXT300	412	X-20-483	338	XSL-21-427-YL-BK	340		
SC-DP4	422	SKO-BKT	425	UXT30DP	412	X-20-483	341	XSL-21-427-YL-BK	340		
SC-DK	422	SKO-CFB	426	V1AE01A	113	X-21-498	340	XSL-23-427	340		
SC-DPR	422	SKO-65W	428	V1CP45A	115	X-23-498	340	XSL-23-427	340		
SC-MB	423	SKO-K2	427	V1DS24A	113	X-24-428-SVBB-BK	338	XSL-23-427-YL-BK	340		
SC-S02	422	SKO-LT	430	V1EP24A	113	X-29-422	341	XSL-23-427-YL-BK	340		
SCAF-STH132	238	SKO-PP	425	V1ESG1G	113	X-29-422	341	XSL-29-427	340		
SCAF-STH132A	238	SKO-SAK	426	V1EW03A	113	X-29-428-SV-BK	338	XSL-29-427	340		
SCAF-STH146	238	SKO-SRP	425	V1EWG1G	113	X-30-422	338	XSL-30-427	340		
SCAF-STSI593	238	SKO-XLT	430	V1FE15A	114	X-30-422	341	XSL-30-427	340		
SCAF-STSI594	238	SKR-20	427	V1FEG1G	114	X-30-428-SV-BK	338	XSL-31-427	340		
SCAF-STSI751	238	SKR-55	428	V1FHG1G	114	X-31-498	340	XSL-31-427	340		
SCAF2-STHUSA	238	SKR-95	429	V1FL15A	113	X-61-483	338	XSL-31-427-YL-BK	340		
SCAF2-STHUSAA	238	SKR-ATK	426	V1LS01A	114	X-61-483	341	XSL-31-427-YL-BK	340		



# Product Index

## BradyID.com/s34

15 Series Numbers & Letters .....	215
34 Series Number & Letters .....	214
5S+ Rapid Improvement Event .....	496
97 Series Number & Letters .....	215

## A

Absorbents & Spill Control .....	412
Accident Prevention Tags .....	230
Admittance Signs .....	28
Aisle Marking Tape .....	270
Aluminum Embossed Numbers & Letters .....	217
Aluminum Utility Panels .....	216
Aluminum Write-On Tags .....	236
Ansi Z535 Signs .....	36
Anti-Skid Floor Tape .....	272
Arc Flash Labels .....	218
Arc Flash Training Aids .....	219

## B

Badge Holder .....	282
Barricade Tape .....	274
BBP31 / BBP33 Label Materials .....	353
BBP31 / BBP33 Print Ribbons .....	379
BBP31 Sign & Label Printer .....	353
BBP33 Label Printer .....	355
BBP85 Label Materials .....	392
BBP85 Print Ribbons .....	396
BBP85 Sign & Label Printer .....	391
Benchtop Printer Comparison .....	346
Benchtop Printers .....	348
Bilingual Signs .....	50
Biohazard Signs .....	61
Biohazard Waste Bags .....	273
Biohazard Labels .....	273
Biohazard Tape .....	273
Blank HPHV Carrier .....	260
Blank Manila Tags .....	236
Blank Signs .....	62
Blank Tyvek White Tags .....	236
Blank Write-On Tags .....	236
BMP21-Plus Materials .....	291
BMP21-Plus Printer .....	290
BMP41 Materials .....	295
BMP41 Printer .....	294
BMP51 / BMP53 Materials .....	302
BMP51 / BMP53 Printer .....	300
BMP71 Materials .....	325
BMP71 Print Ribbons .....	337
BMP71 Printer .....	324
Bradycone Warning Cones .....	277
Bradyglo Marking Tape .....	273
BradyGlo Numbers & Letters .....	217
Bradylink Posts & Chain .....	276
Bradylite Numbers & Letters .....	216
Bradylock™ Fastener .....	260
Braille Signs .....	63
Brass Valve Tags .....	243

## C

Cabinet Label .....	226
Cable Lock Seals .....	282

Cable Lockouts .....	475
Chain Lockout Kit .....	448
Chemical Absorbents .....	416
Chemical Signs .....	64
Circuit Breaker Lockout Guide .....	478
Codesoft Software .....	409
Color-Coded Lock-On Tags .....	237
Color-Coded Plasti-Tags .....	237
Conduit & Voltage Labels .....	220
Confined Space Manhole Cover .....	84
Confined Space Procedure Writing Service .....	495
Confined Space Signs .....	82
Confined Space Tags .....	232
Construction Site Signs .....	85
Consulting Services .....	494
Container Label .....	227
Conveyor Labels .....	221
Custom GHS labels .....	206
Custom Signs .....	193
Custom Tank & Vessel Signs .....	207
Custom Valve Tags .....	240
Cylinder Status Tags .....	234

## D

Directional Flow Arrow Tape .....	259
Dispensers .....	284
Door Signs .....	86
DOT Placard Frames .....	81
DOT Placard Signs .....	79
Drum Cover Absorbents .....	419

## E

E-Vehicle Signs .....	174
Ear Plug Dispensers .....	285
Electrical Hazard Signs .....	88
Electrical Lockouts .....	482
Energy Source Tags .....	458
Envelopes .....	233
Exit & Directional Signs .....	91
Eye Protection Dispensers .....	284

## F

Fire Extinguisher Labels .....	227
Fire Safety Signs .....	100
First Aid Signs .....	107
Flag Style Blind Tag .....	232
Flagging Tape .....	275
Floor Signs .....	110
Floor Stands .....	277
Food & Beverage Arrow Tape .....	252
Food & Beverage Pipe Markers .....	252
Funny Signs .....	112

## G

Gas & Air Lockouts .....	487
Gas Cylinder Labels .....	225
Gauge Marking Labels .....	229
GHS Labels .....	204
GHS Training Aids .....	164
Globalmark Label Materials .....	382

Globalmark Label Printer.....	381
Globalmark Printer Ribbon.....	389
Glow-in-the-Dark Numbers & Letters.....	217
Gothic Quik-Align Number & Letters.....	217
Gothic Quik-Align Numbers & Letters.....	217
Granular Absorbents.....	421

## H

Hand Sealing Press.....	280
Handicapped Parking Signs.....	172
HandiMark Accessories.....	342
HandiMark Materials.....	342
Hard Hat Emblem Labels.....	228
Hazardous Material Shipping Labels.....	210
Hazardous Waste Labels.....	208
Heavy-Duty Mounting Clips.....	260
Helvetica Quik-Align Ten Packs.....	217
High Performance Pipe Marker.....	258
High Visibility Signs.....	113
Hospital Signs.....	116

## I

ID PRO Accessories.....	344
ID PRO Materials.....	344
IDXPRT Accessories.....	338
IDXPRT Materials.....	338
IAR Pipe Markers.....	249
IMO Signs.....	99
Inseption / Recharge Maintenance Tags.....	233
Inspection & Material Control Tags.....	233
InspectNTrack Software.....	407
ISO 14726 Pipe Banding Tape.....	259
ISO Prohibition Labels.....	220
ISO Warning Labels.....	220
Isolation Blind Tags.....	232

## L

Labelizer Label Materials.....	397
Labelizer Printer.....	397
Labelmark Software.....	408
Labels.....	218
Labels & Tags.....	218
Laminators.....	402
Lanyards.....	282
Link360 Lockout Procedure Software.....	406
Lock Boxes.....	472
Lockout Hasp.....	473
Lockout Hasps.....	474
Lockout Labels.....	493
Lockout Procedures.....	490
Lockout Signs.....	493
Lockout Stations.....	452
Lockout Tagout.....	440
Lockout Tagout Kits.....	440
Lockout Tagout Poster.....	163
Lockout Tagout Procedure Writing Service.....	494
Lockout Tagout Signs.....	118
Lockout Tagout Training.....	488
Lockout Tags.....	461

## M

Machine / Equipment Labels.....	222
Machine & Operational Signs.....	120
Magnet Numbers.....	166
Maintenance Signs.....	132
Marine Absorbents.....	420
Mat & Rug Absorbents.....	417
Medical Pipe Marker.....	255
Medical Roll Form Pipe Marker.....	255
Metal Ball Seals.....	282
Metal Seals.....	282
Metal Write-On Tags.....	237
Minimark Label Materials.....	349
Minimark Label Printer.....	348
Minimark Printer Ribbon.....	351
Mr. Ouch Transformer Labels.....	220
Muster Signs.....	98

## N

No Cellular Phones Signs.....	135
No Smoking Signs.....	136
Number & Letter Labels.....	214
Nylon Fasteners.....	381
Nylon Straps.....	260

## O

Oil Only Absorbents.....	414
Outdoor Numbers & Letters.....	216

## P

Packlock Storage.....	471
Padlock Labels.....	470
Padlock Plastic Seals.....	282
Padlocks.....	466
Parking Permits.....	282
Pavement Tape.....	193
Personal Hygiene Signs.....	142
Personal Protection Signs.....	143
Pillow Absorbents.....	419
Pipe Marker Blanks.....	401
Pipe Marker-TO-GO.....	254
Pipe Markers.....	249
Pipe Markers Banding Tape.....	259
Pipe Markers Fasteners.....	260
Portable Printer Comparison.....	288
Portable Printers.....	290
Post Driver.....	191
PPE Signs.....	143
Pre-printed KVA Markers.....	216
Procedure Writing Services.....	497
Production Tags.....	235
Pull-Tite Seals.....	282

## Q

Quik-Apply™ Nylon Straps.....	260
-------------------------------	-----



# Product Index

BradyID.com/s34

## R

Radiation & Laser Signs .....	155
Rail Signs.....	175
Recycle & Environment Signs .....	158
Red Tag Signs .....	263
Red Tags .....	263
Reflective Pipe Banding .....	259
Reflective Quik-Lite Numbers & Letters .....	216
Restroom Signs .....	159
Right To Know Labels.....	208
Ring-Loc Drum Seals .....	282
Road Construction Accessories.....	171
Road Construction Signs.....	171
Roll-Form Pipe Marker.....	253

## S

Safety & Regulatory.....	204
Safety Banners .....	160
Safety Information Centers .....	211
Safety Mirrors .....	278
Safety Posters.....	163
Safety Sign Slider Boards.....	188
Safety Sign Sliders .....	188
Safety Signs.....	28
Safety Slogan Signs .....	165
Safety Training And Seminars .....	496
Scaffolding Tags.....	238
Scoreboard Signs.....	166
Seals.....	282
Security.....	280
Security Badges .....	282
Security Camera.....	282
Security Signs.....	167
Self Sticking Pipe Markers.....	250
Self Sticking Vinyl Arrows .....	259
Self-Laminating Blank Tags.....	234
Self-Laminating Tags.....	234
self-sticking pipe marker - Food & Beverage.....	252
self-sticking pipe marker spanish .....	251
Self-Sticking Pipe Markers .....	250
Semiconductor Pipe Marker.....	255
Seriessystem Kit .....	215
Sign Accessories.....	190
Sign Base .....	191
Sign Blanks.....	400
Sign Fasteners.....	190
Sign Fence Bracket.....	192
Sign Mounting Tape.....	190
Sign Posts.....	190
Slow Moving Vehicle Sign .....	192
Snap-On Strap-on Pipe Marker .....	256
SOC Absorbents .....	418
Software.....	404
Solid Color Banding Tape.....	259
Spill Containment .....	422
Spill Kits.....	425
Stainless Steel Banding Heads .....	260
Stainless Steel Safety Wire .....	260
Stainless Steel Strapping .....	260
Stock IIAR Tape .....	259
Stock Plastic Truck Seals .....	282

## T

Tags.....	230
Tape Strip Rolls.....	260
Temporary Signs .....	169
Tensabarrier Barricades .....	278
TLS 2200 Materials.....	311
TLS 2200 Print Ribbons.....	323
TLS 2200 Printer .....	310
TLS PC Link Label Printer.....	310
Toughstripe Diecut Shapes .....	266
Toughstripe Floor Signs.....	267
Toughstripe for BMP71 .....	269
Toughstripe For Globalmark.....	269
Toughstripe Kits.....	268
Toughstripe Numbers & Letters.....	214
Toughstripe Pre-Printed Tape .....	269
Toughstripe Pre-Spaced Tape.....	266
Toughstripe Signs.....	111
Toughstripe Tape .....	265
Traffic Barrel .....	193
Traffic Barricades .....	193
Traffic Cones.....	193
Traffic Control .....	171
Traffic Emergency Road Triangles .....	192
Traffic Paddles.....	192
Traffic Signs .....	176

## U

U-Channel Posts.....	190
Underground Warning Tape .....	275
Universal Absorbents .....	412

## V

Valve Lockouts .....	476
Valve Tag Blanks .....	400
Valve Tags .....	243
Versaprinter Label & Sign Maker.....	397
Visual Workplace .....	270
Visual Workplace Audits .....	495
Visual Workplace Diecut Markers .....	271
Visual Workplace Installation Services .....	497
Visual Workplace Marking.....	270
Visual Workplace Marking Tape .....	270
Visual Workplace Production Services .....	497
Visual Workplace Training .....	279

## W

Warning Stakes .....	278
Workstation App Software .....	404
Wristbands .....	282
Write-On Inspection Labels.....	221
Write-On Magnetic Labels.....	229

## Z

Zip-Lock Envelopes.....	237
Zip Fasteners.....	260

CONTINUE  
SHOPPING AT

**BradyID.com/s34**

- View full product lines
- Additional product info, videos and photos
- Industry Expertise
- Manufacturer-suggested pricing
- Online ordering
- Browse additional Brady catalogs



Scan now or visit:  
**BradyID.com/s34**

# Trusted Safety Adviser for 100 Years



**BradyID.com/s34**

Your resource for safety, facility  
and equipment identification.

Order Online  
Product Videos  
Product Info

Industry Expertise  
Best practices  
And More!

**Custom solutions  
also available!**

Also find Brady on:



Brady warrants only to the buyer that the products and parts set forth herein will be free from defects in material and workmanship from the date of purchase for a period of one year. Brady's sole obligation under the above warranty shall be to repair or replace the defective products or parts during the warranty period. NO OTHER WARRANTIES, EXPRESS OR IMPLIED, ARE GIVEN, AND BRADY EXPRESSLY DISCLAIMS ALL OTHER WARRANTIES, INCLUDING AND WITHOUT LIMITATION, ANY IMPLIED WARRANTIES OF MERCHANTABILITY OR FITNESS FOR A PARTICULAR PURPOSE. All statements, technical information, or recommendations relating to the products or parts are based upon tests believed to be reliable, but do not constitute a guaranty or warranty. BRADY SHALL NOT UNDER ANY CIRCUMSTANCES WHATSOEVER BE LIABLE TO ANY PARTY FOR LOSS OF PROFITS, DIMINUTION OF GOOD WILL, OR ANY OTHER SPECIAL, CONSEQUENTIAL, OR INCIDENTAL DAMAGES WHATSOEVER WITH RESPECT TO ANY CLAIM IN CONNECTION WITH BRADY PRODUCTS AND/OR PARTS. Brady's maximum liability for warranty claims is limited to the invoice price of the product or price claimed defective.

PRICES AND AVAILABILITY ARE SUBJECT TO CHANGE WITHOUT NOTICE.

USA  
Customer Service: 1-888-272-3946  
Inside Sales: 1-888-311-0775  
www.BradyID.com

Canada  
Customer Service: 1-800-263-6179  
www.BradyCanada.ca

Mexico  
Customer Service: 1-800-262-7777  
Inside Sales: 1-800-262-7777 ext 177  
www.BradyLatinAmerica.com



© 2015 Brady Worldwide, Inc. All Rights Reserved.

**BRADY**  
WHEN PERFORMANCE MATTERS MOST™