

Contents

157 ▶ DISCONNECT SWITCHES

25A / 32A.....	158
50A / 63A.....	172
80A / 100A.....	183
Technical Specifications.....	196

Disconnect Switches

A modular and flexible range



Contact gap
7 mm

**Reversible
terminal feature**

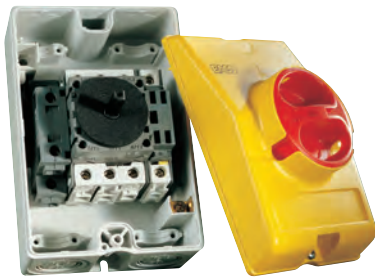

► IN ENCLOSURE

- Degree of protection: up to IP 66
- For 25A to 100A size switches
- Cable entries with pre-formed knockouts
- Tamper-proof cover with padlockable handle
- Recessed area for optional plate
- A wide choice of associated contact blocks and enclosures available

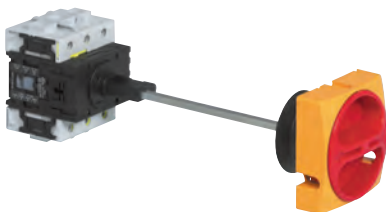

► WITH CLUTCH DRIVE

- Metal shafts can be cut to length required
- With or without door interlock system
- Short or long metal shafts available

25A / 32A

▶ DOOR/PANEL MOUNTING

 Technical Info (p. 196)

PADLOCKABLE PRESENTATION



0172001



0174101

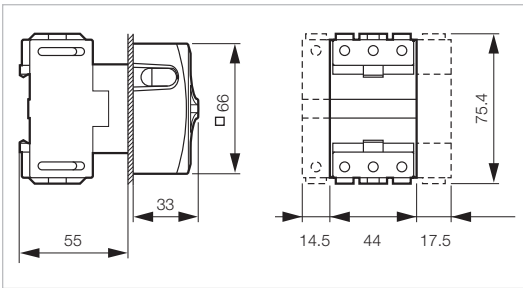

Yellow/Red Handle
Part Number

Grey Handle
Part Number

25 A

- 3P
- 3P + NC/NO
- 4P neutral on left
- 4P + NC/NO

- 0172001
- 0172011
- 0172021
- 0172031

- 0174001
- 0174011
- 0174021
- 0174031

32 A

- 3P
- 3P+NC/NO
- 4P neutral on left
- 4P + NC/NO

- 0172101
- 0172111
- 0172121
- 0172131

- 0174101
- 0174111
- 0174121
- 0174131

STANDARD VERSIONS IP40 RATED.

TO ORDER WITH IP65 GASKETS ADD -1 TO PART NUMBERS ABOVE.
IE. 0172001-1

COMPONENTS AND ACCESSORIES

Part Number



0172000

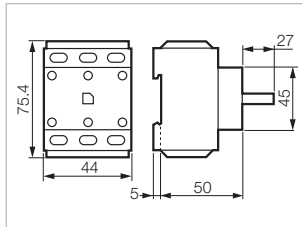

3-pole switch body without handle

- 25 A
- 32 A

- 0172000
- 0172100

Additional pole

- 25 A
- 32 A

- 0172075
- 0172175

Neutral pole

- 25 A
- 32 A

- 0172065
- 0172165

Junction block

Ground or Neutral

0172185

Auxiliary contact - 10A

NC/NO

0172179

IP65 Seal Kit

0172267

Replacement Handle

- 66 - Yellow/Red
- 66 - Grey

- 0172601
- 0174601



0172065

0172185

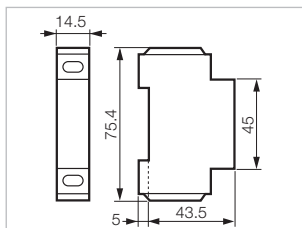

25A / 32A

▶ DOOR/PANEL MOUNTING

 Technical Info (p.196)

NON- PADLOCKABLE PRESENTATION

Yellow/Red Handle Part Number Grey Handle Part Number



0172002



0174102

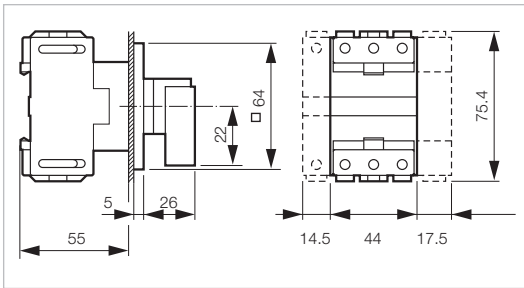

25 A

3P	0172002	0174002
3P + NC/NO	0172012	0174012
4P neutral on left	0172022	0174022
4P + NC/NO	0172032	0174032

32 A

3P	0172102	0174102
3P + NC/NO	0172112	0174112
4P neutral on left	0172122	0174122
4P + NC/NO	0172132	0174132

STANDARD VERSIONS IP40 RATED.
TO ORDER WITH IP65 GASKETS ADD -1 TO PART NUMBERS ABOVE.
IE. 0172002-1

COMPONENTS AND ACCESSORIES

Part Number



0172179

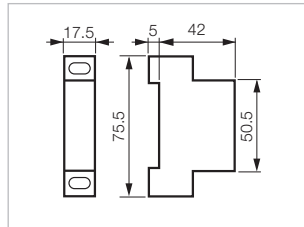

3-pole switch body without handle

25 A	0172000
32 A	0172100

Additional pole

25 A	0172075
32 A	0172175

Neutral pole

25 A	0172065
32 A	0172165

Junction block Ground or Neutral

0172185

Auxiliary contact - 10A

NC/NO	0172179
-------	----------------

IP65 Seal Kit

0172267

Replacement Handle, Plate, and Frame

<input type="checkbox"/> 64 - Yellow/Red	0172602
<input type="checkbox"/> 64 - Grey	0174602

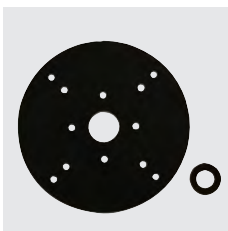

0172267

25A / 32A

▶ DOOR/PANEL MOUNTING

 Technical Info (p.196)

PADLOCKABLE PRESENTATION Ø 22 SINGLE-HOLE MOUNTING

Yellow/Red Handle
Part Number



0172003

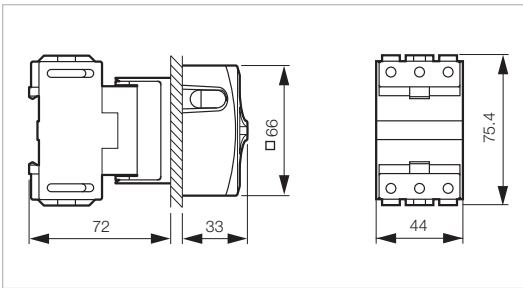

25 A

3P	0172003
3P + NC/NO	0172013
4P neutral on left	0172023
4P + NC/NO	0172033

32 A

3P	0172103
3P+NC/NO	0172113
4P neutral on left	0172123
4P + NC/NO	0172133

STANDARD VERSIONS IP65 RATED.

COMPONENTS AND ACCESSORIES

Part Number



0172000

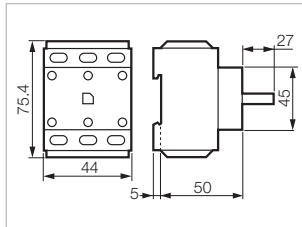

3-pole switch body without handle

25 A	0172000
32 A	0172100

Additional pole

25 A	0172075
32 A	0172175

Neutral pole

25 A	0172065
32 A	0172165

Junction block Ground or Neutral

0172185

Auxiliary contact - 10A

NC/NO	0172179
-------	---------

Replacement Handle

□ 66 - Ø 22 single-hole-mounting - Yellow/Red	0172603
---	---------



0172065 0172185

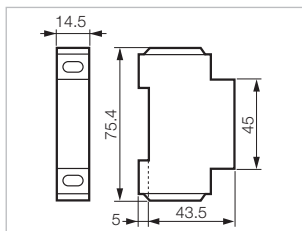

25A / 32A

▶ DOOR/PANEL MOUNTING

 Technical Info (p.196)

NON-PADLOCKABLE PRESENTATION Ø 22 SINGLE-HOLE MOUNTING

Yellow/Red Handle
Part Number



0172004

25 A

3P	0172004
3P+NC/NO	0172014
4P neutral on left	0172024

32 A

3P	0172104
3P+NC/NO	0172114
4P neutral on left	0172124

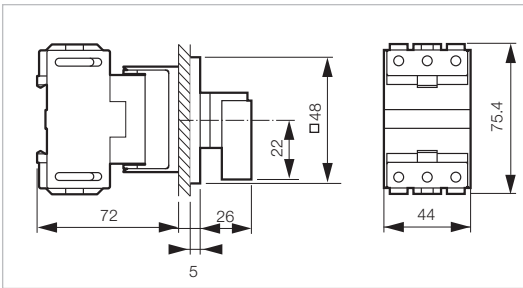

STANDARD VERSIONS IP65 RATED.

COMPONENTS AND ACCESSORIES

Part Number



0172179

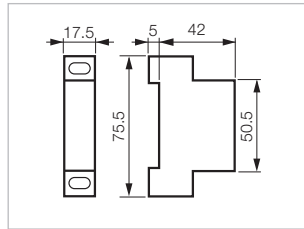

3-pole switch body without handle

25 A	0172000
32 A	0172100

Additional pole

25 A	0172075
32 A	0172175

Neutral pole

25 A	0172065
32 A	0172165

Junction block

Ground or Neutral	0172185
-------------------	----------------

Auxiliary contact - 10A

NC/NO	0172179
-------	----------------

Replacement Handle, Plate, and Frame

<input type="checkbox"/> 48 - Ø 22 single-hole-mounting - Yellow/Red	0172604
--	----------------

25A / 32A

► DIN-RAIL IN-PANEL MOUNTING

 Technical Info (p.196)

PADLOCKABLE PRESENTATION

Grey Handle
Part Number



0174005

25 A

3P
3P + NC/NO
4P neutral on left
4P + NC/NO

0174005
0174015
0174025
0174035

32 A

3P
3P+NC/NO
4P neutral on left
4P + NC/NO

0174105
0174115
0174125
0174135

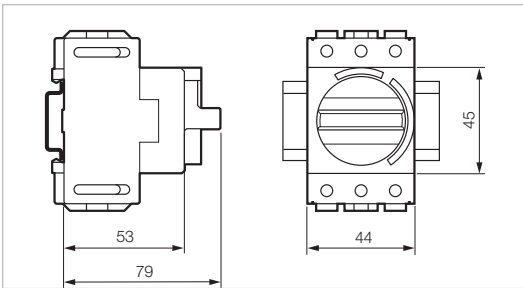

COMPONENTS AND ACCESSORIES

Part Number



0172000

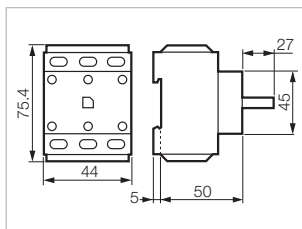

3-pole switch body without handle

25 A
32 A

0172000
0172100

Additional pole

25 A
32 A

0172075
0172175

Neutral pole

25 A
32 A

0172065
0172165



0172065

0172185

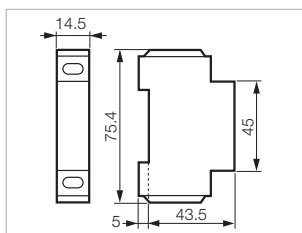

Junction block Ground or Neutral

0172185

Auxiliary contact - 10A

NC/NO

0172179

25A / 32A

▶ DOOR INTERLOCK MOUNTING - NO METAL SHAFT EXTENSION

 Technical Info (p.196)

PADLOCKABLE PRESENTATION

Yellow/Red Handle
Part Number

Grey Handle
Part Number



0165009NS

25 A

3P
3P + NC/NO
4P neutral on left
4P + NC/NO

0165009NS
0165019NS
0165029NS
0165039NS

0168009NS
0168019NS
0168029NS
0168039NS



0168109NS

32 A

3P
3P + NC/NO
4P neutral on left
4P + NC/NO

0165109NS
0165119NS
0165129NS
0165139NS

0168109NS
0168119NS
0168129NS
0168139NS

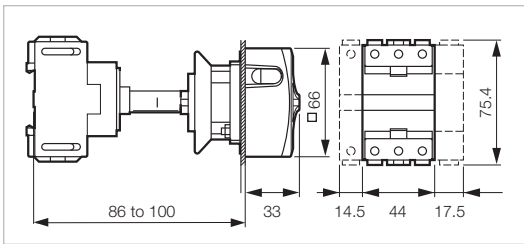

STANDARD VERSIONS IP40 RATED.
TO ORDER WITH IP65 GASKETS ADD -1 TO PART NUMBERS ABOVE.
IE. 0165009NS-1

COMPONENTS AND ACCESSORIES

Part Number



0172179

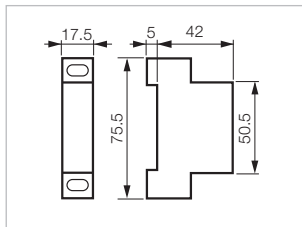

3-pole switch body without handle

25 A
32 A

0172000
0172100

Additional pole

25 A
32 A

0172075
0172175

Neutral pole

25 A
32 A

0172065
0172165

Junction block
Ground or Neutral

0172185

Auxiliary contact - 10A

NC/NO

0172179

IP65 Seal Kit

0174259

Replacement Handle

66 - Yellow/Red
 66 - Grey

0172601
0174601



0174259

25A / 32A

▶ DOOR INTERLOCK MOUNTING - SHORT METAL SHAFT EXTENSION



Technical Info (p.196)

PADLOCKABLE PRESENTATION

Yellow/Red Handle
Part Number

Grey Handle
Part Number

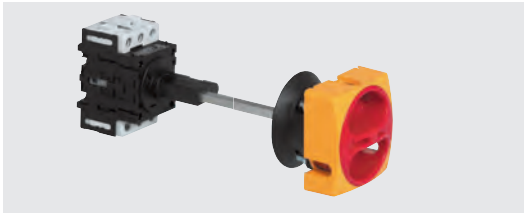

0165009SS

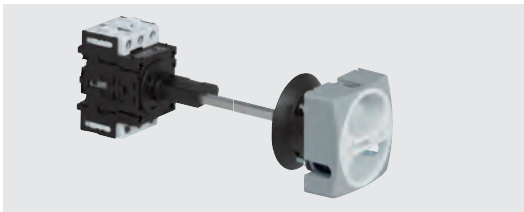

0168109SS

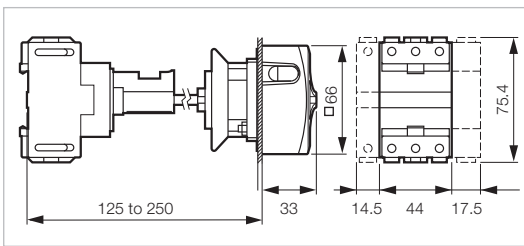

25 A

- 3P
- 3P + NC/NO
- 4P neutral on left
- 4P + NC/NO

- 0165009SS
- 0165019SS
- 0165029SS
- 0165039SS

- 0168009SS
- 0168019SS
- 0168029SS
- 0168039SS

32 A

- 3P
- 3P + NC/NO
- 4P neutral on left
- 4P + NC/NO

- 0165109SS
- 0165119SS
- 0165129SS
- 0165139SS

- 0168109SS
- 0168119SS
- 0168129SS
- 0168139SS

STANDARD VERSIONS IP40 RATED.

TO ORDER WITH IP65 GASKETS ADD -1 TO PART NUMBERS ABOVE.
IE. 0165009SS-1

COMPONENTS AND ACCESSORIES

Part Number



0172000

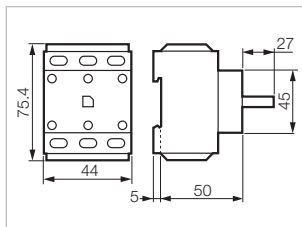

3-pole switch body without handle

- 25 A
- 32 A

- 0172000
- 0172100

Additional pole

- 25 A
- 32 A

- 0172075
- 0172175

Neutral pole

- 25 A
- 32 A

- 0172065
- 0172165

Junction block
Ground or Neutral

- 0172185

Auxiliary contact - 10A

- NC/NO

- 0172179

IP65 Seal Kit

- 0174259

Replacement Handle

- 66 - Yellow/Red
- 66 - Grey

- 0172601
- 0174601



0172065 0172185

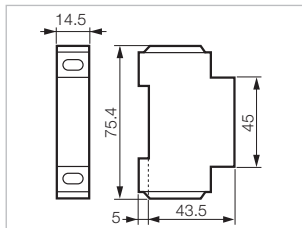

25A / 32A

▶ DOOR INTERLOCK MOUNTING - LONG METAL SHAFT EXTENSION



PADLOCKABLE PRESENTATION

Yellow/Red Handle
Part Number

Grey Handle
Part Number

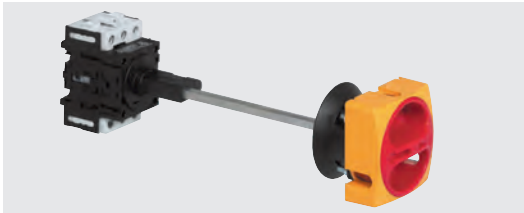

0165009LS

25 A

3P
3P + NC/NO
4P neutral on left
4P + NC/NO

0165009LS
0165019LS
0165029LS
0165039LS

0168009LS
0168019LS
0168029LS
0168039LS

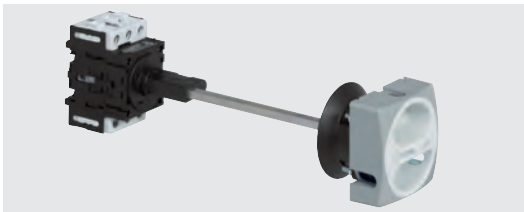

0168109LS

32 A

3P
3P + NC/NO
4P neutral on left
4P + NC/NO

0165109LS
0165119LS
0165129LS
0165139LS

0168109LS
0168119LS
0168129LS
0168139LS

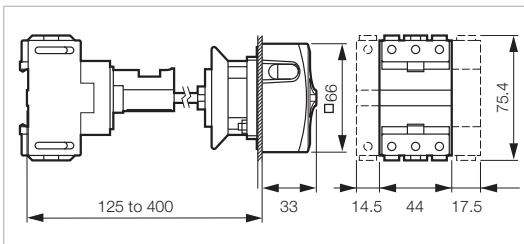

STANDARD VERSIONS IP40 RATED.

TO ORDER WITH IP65 GASKETS ADD -1 TO PART NUMBERS ABOVE.
IE. 0165009LS-1

COMPONENTS AND ACCESSORIES

Part Number



0172179

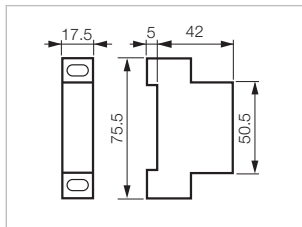

3-pole switch body without handle

25 A
32 A

0172000
0172100

Additional pole

25 A
32 A

0172075
0172175

Neutral pole

25 A
32 A

0172065
0172165

Junction block
Ground or Neutral

0172185

Auxiliary contact - 10A

NC/NO

0172179

IP65 Seal Kit

0174259

Replacement Handle

- 66 - Yellow/Red
- 66 - Grey

0172601
0174601



0174259

25A / 32A

► ENCLOSURES

 Technical Info (p.196)

PADLOCKABLE PRESENTATION



0172061

0174161

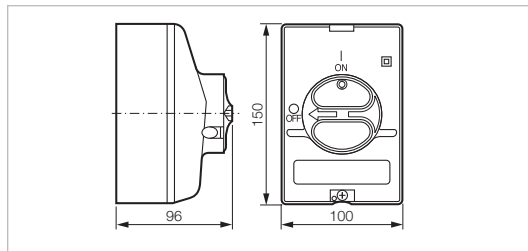

Cable entries: 6 x PG16 and 4 x M25

25 A

- 3P
- 3P + NC/NO
- 4P neutral on left
- 4P + NC/NO

Yellow/Red Handle
Part Number

- 0172061
- 0172071
- 0172081
- 0172091

Grey Handle
Part Number

- 0174061
- 0174071
- 0174081
- 0174091

32 A

- 3P
- 3P+NC/NO
- 4P neutral on left
- 4P + NC/NO

- 0172161
- 0172171
- 0172181
- 0172191

- 0174161
- 0174171
- 0174181
- 0174191

STANDARD VERSIONS IP66 RATED.

PADLOCKABLE PRESENTATION



0172009

0174109

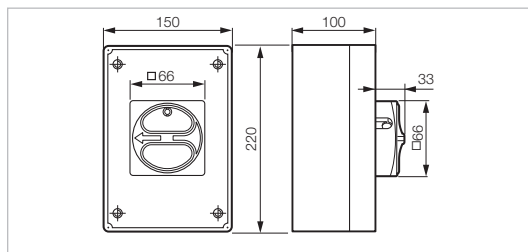

Cable entries: 4 x PG21

25 A

- 6P
- 6P + NC/NO

Yellow/Red Handle
Part Number

- 0172009
- 0172029

Grey Handle
Part Number

- 0174009
- 0174029

32 A

- 6P
- 6P+NC/NO

- 0172109
- 0172129

- 0174109
- 0174129

STANDARD VERSIONS IP40 RATED.
TO ORDER WITH IP65 GASKETS ADD -6 TO PART NUMBERS ABOVE.
IE. 0172009-6

CABLE GLANDS



PG16-GY

- PG16
- PG21

- Cable Range 10mm - 14mm
- Cable Range 13mm - 18mm

Part Number

- PG16-GY
- PG21-GY

25A / 32A

► ENCLOSURES

 Technical Info (p.196)

NON- PADLOCKABLE PRESENTATION



0172062

0174162

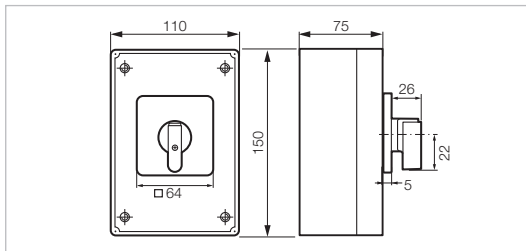

Cable entries: 4 x PG16

25 A

- 3P
- 3P + NC/NO
- 4P neutral on left
- 4P + NC/NO

Yellow/Red Handle
Part Number

- 0172062
- 0172072
- 0172082
- 0172092

Grey Handle
Part Number

- 0174062
- 0174072
- 0174082
- 0174092

32 A

- 3P
- 3P+NC/NO
- 4P neutral on left
- 4P + NC/NO

- 0172162
- 0172172
- 0172182
- 0172192

- 0174162
- 0174172
- 0174182
- 0174192

STANDARD VERSIONS IP40 RATED.

TO ORDER WITH IP65 GASKETS ADD -6 TO PART NUMBERS ABOVE.

IE. 0172062-6

NON-PADLOCKABLE PRESENTATION



0172019

0174119

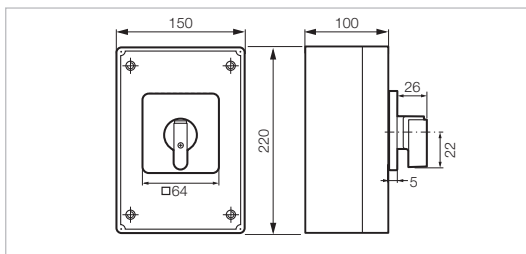

Cable entries: 4 x PG21

25 A

- 6P
- 6P + NC/NO

Yellow/Red Handle
Part Number

- 0172019
- 0172039

Grey Handle
Part Number

- 0174019
- 0174039

32 A

- 6P
- 6P+NC/NO

- 0172119
- 0172139

- 0174119
- 0174139

STANDARD VERSIONS IP40 RATED.

TO ORDER WITH IP65 GASKETS ADD -6 TO PART NUMBERS ABOVE.

IE. 0172019-6

CABLE GLANDS



PG16-GY

- PG16
- PG21

- Cable Range 10mm - 14mm
- Cable Range 13mm - 18mm

Part Number

- PG16-GY
- PG21-GY

25A / 32A

► BLOCKS

 Technical Info (p.196)

Part Number



0172000

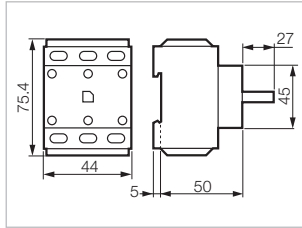

3-pole switch body without handle

25 A
32 A

0172000
0172100



0172065 0172185

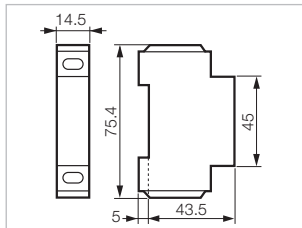

Additional pole
(for use in enclosure only)

25 A
32 A

0172075
0172175

Neutral pole

25 A
32 A

0172065
0172165

Junction block
Ground or Neutral

0172185



0172179

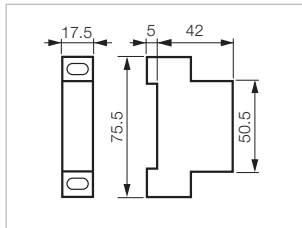

Auxiliary contact - 10A

NC/NO

0172179

1 pole early break

0172195



0172195

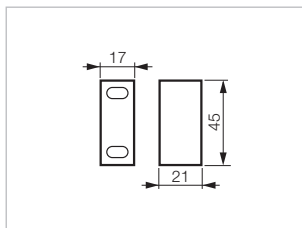

25A / 32A

▶ HANDLES

 Technical Info (p.196)

Part Number



0172601

Padlockable presentation

Padlock with $\varnothing 6$ to 8 mm

- 66 - Yellow/Red
- 66 - Grey
- 66 - $\varnothing 22$ single-hole-mounting - Yellow/Red

0172601
0174601
0172603

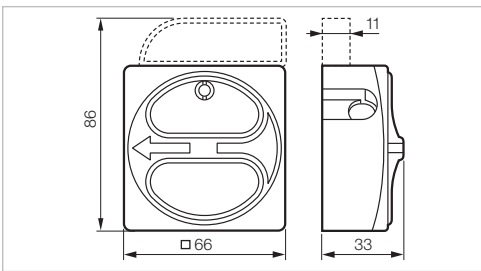

0172602

Dim. Ref. 0172602

- A: 64
- B: 80

Dim. ref. 0172604

- A: 48
- B: 65

With plate, frame and handle

- 64 - Yellow/Red
- 48 - $\varnothing 22$ single-hole-mounting - Yellow/Red

0172602

0172604

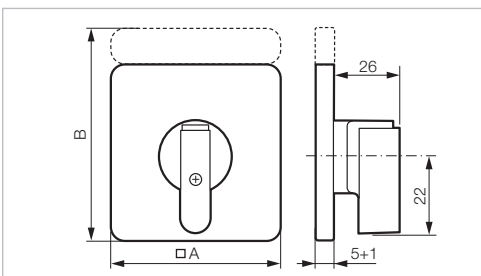

25A / 32A

▶ EMPTY ENCLOSURES

 Technical Info (p.196)

PADLOCKABLE PRESENTATION

Part Number



0172399

Dimensions 150 x 100 x 96 mm
 Supplied with padlockable handle,
 weatherproof seal and relay terminal
 For 3 and 4-pole switches with and without NC/NO
 Cable entries: 4 x PG16/M25

IP66-IK7

Grey base - yellow cover - red handle
 Grey base - grey cover - grey handle

0172399
 0174399

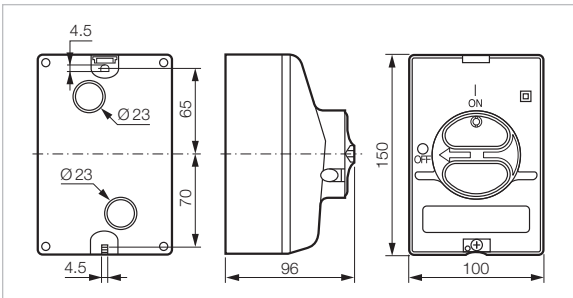

WITHOUT HANDLE



0172549

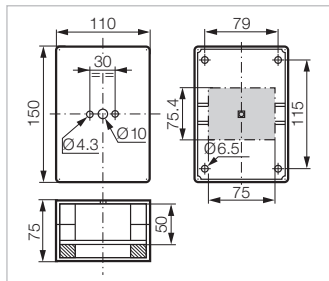

Grey - Up to 4 poles + auxiliary contact
 150 x 110 x 75 mm
 Cable entries: 4 x PG16

0172549



0172559

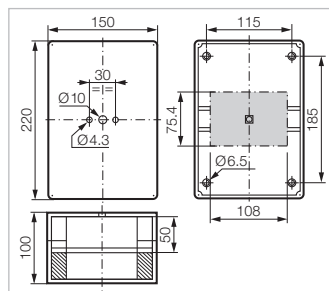

Grey - Up to 6 poles + auxiliary contact
 220 x 150 x 100 mm
 Cable entries: 4 x PG21

0172559

▶ ACCESSORIES

 Technical Info (p. 196)

Part Number



0172167



0174569



0172649

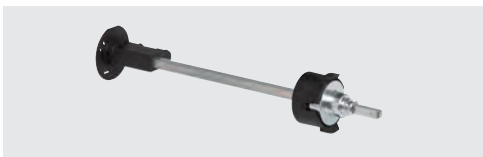

0174189



0174179



0174249

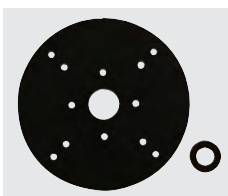

0172267



0174259



PG16-GY



STM25

Terminal covers

For 3-pole body switch **0172167**
 For additional pole, neutral pole or junction block **0172177**
 For auxiliary contact NC/NO (pair) **0172189**
 For early break auxiliary contact **0172199**

Connection terminal kit

Terminal connection for ground or neutral **0174449**

Self-adhesive plates (for enclosures)

Blank **0174599**
 Engraved MAIN SWITCH **0174569**

Duty labels

Blank **0172629**
 Engraved MAIN SWITCH **0172649**

Kit for clutch drive presentation

Short shaft without door interlock **0174189**
 Long shaft without door interlock **0174199**
 Without shaft and without door interlock **0174179**

Kit for door interlock

0174249

IP 65 seal kits

For front mounting switches and enclosures

Padlockable 66 or plate and frame 64 or 72 **0172267**

For rear mounting switches with clutch drive

Padlockable 66 or plate and frame 64 or 72 **0174259**

Cable Glands

PG16 Cable Range 10mm - 14mm **PG16-GY**
 PG21 Cable Range 13mm - 18mm **PG21-GY**

Stepped Gland

M25 Cable Range 5mm - 21mm **STM25**

50A / 63A

▶ DOOR/PANEL MOUNTING

 Technical Info (p.196)

PADLOCKABLE PRESENTATION

Yellow/Red Handle
Part Number

Grey Handle
Part Number



0172201



0174201

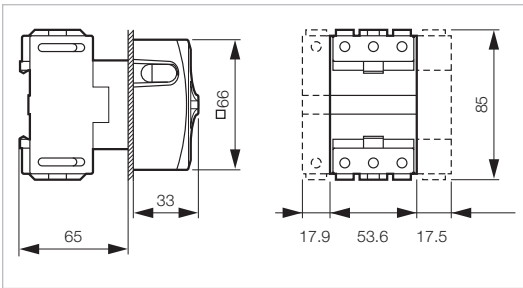

50 A

- 3P
- 3P + NC/NO
- 4P neutral on left
- 4P + NC/NO

- 0172201
- 0172211
- 0172221
- 0172231

- 0174201
- 0174211
- 0174221
- 0174231

63 A

- 3P
- 3P+NC/NO
- 4P neutral on left
- 4P + NC/NO

- 0172301
- 0172311
- 0172321
- 0172331

- 0174301
- 0174311
- 0174321
- 0174331

STANDARD VERSIONS IP40 RATED.
TO ORDER WITH IP65 GASKETS ADD -1 TO PART NUMBERS ABOVE.
IE. 0172201-1

COMPONENTS AND ACCESSORIES

Part Number



0172300

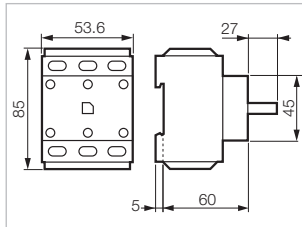

3-pole switch body without handle

- 50 A
- 63 A

- 0172200
- 0172300

Additional pole

- 50 A
- 63 A

- 0172275
- 0172375

Neutral pole

- 50 A
- 63 A

- 0172265
- 0172365

Junction block
Ground or Neutral

- 0172385

Auxiliary contact - 10A

NC/NO

- 0172179

IP65 Seal Kit

- 0172267

Replacement Handle

- 66 - Yellow/Red
- 66 - Grey

- 0172601
- 0174601



0172375

0172385

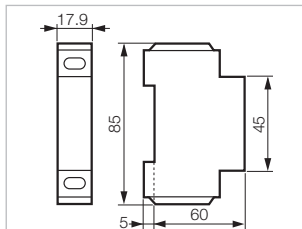

50A / 63A

▶ DOOR/PANEL MOUNTING

 Technical Info (p.196)

NON- PADLOCKABLE PRESENTATION

Yellow/Red Handle
Part Number

Grey Handle
Part Number



0172202



0174202

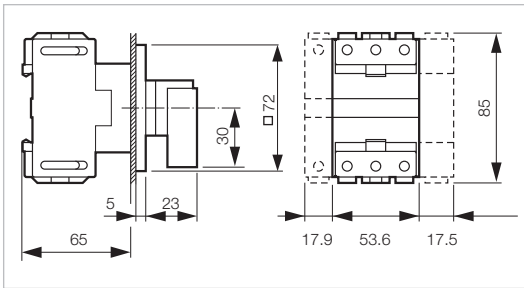

50 A

- 3P
- 3P + NC/NO
- 4P neutral on left
- 4P + NC/NO

- 0172202
- 0172212
- 0172222
- 0172232

- 0174202
- 0174212
- 0174222
- 0174232

63 A

- 3P
- 3P + NC/NO
- 4P neutral on left
- 4P + NC/NO

- 0172302
- 0172312
- 0172322
- 0172332

- 0174302
- 0174312
- 0174322
- 0174332

STANDARD VERSIONS IP40 RATED.
TO ORDER WITH IP65 GASKETS ADD -1 TO PART NUMBERS ABOVE.
IE. 0172002-1

COMPONENTS AND ACCESSORIES

Part Number



0172179

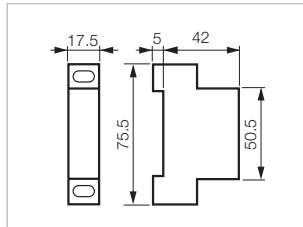

3-pole switch body without handle

- 50 A
- 63 A

- 0172200
- 0172300

Additional pole

- 50 A
- 63 A

- 0172275
- 0172375

Neutral pole

- 50 A
- 63 A

- 0172265
- 0172365

Junction block

Ground or Neutral

0172385

Auxiliary contact - 10A

NC/NO

0172179

IP65 Seal Kit

0172267

Replacement Handle

- 72 - Yellow/Red
- 72 - Grey

- 0172612
- 0174612



0172395

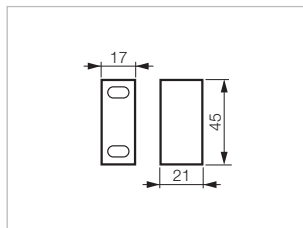

50 A / 63A

► DIN-RAIL IN-PANEL MOUNTING

 Technical Info (p.196)

PADLOCKABLE PRESENTATION

Grey Handle
Part Number



0174205

50 A

3P
3P + NC/NO
4P neutral on left
4P + NC/NO

0174205
0174215
0174225
0174235

63 A

3P
3P+NC/NO
4P neutral on left
4P + NC/NO

0174305
0174315
0174325
0174335

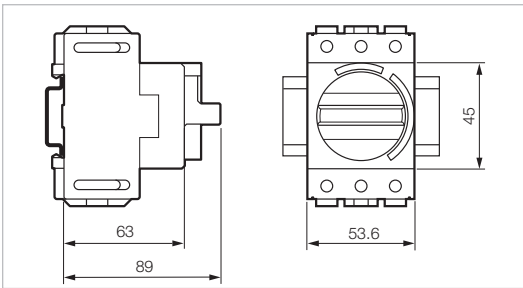

COMPONENTS AND ACCESSORIES

Part Number



0172300

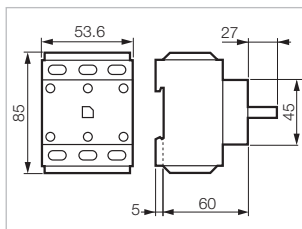

3-pole switch body without handle

50 A
63 A

0172200
0172300

Additional pole

50 A
63 A

0172275
0172375

Neutral pole

50 A
63 A

0172265
0172365

Junction block Ground or Neutral

0172385

Auxiliary contact - 10A

NC/NO

0172179



0172375

0172385

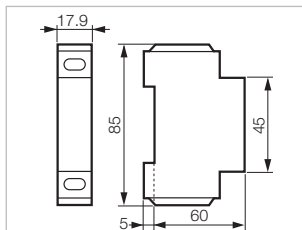

50A / 63A

▶ DOOR INTERLOCK MOUNTING - NO METAL SHAFT EXTENSION



PADLOCKABLE PRESENTATION

Yellow/Red Handle
Part Number

Grey Handle
Part Number



0165209NS

50 A

3P
3P + NC/NO
4P neutral on left
4P + NC/NO

0165209NS
0165219NS
0165229NS
0165239NS

0168209NS
0168219NS
0168229NS
0168239NS



0168209NS

63 A

3P
3P + NC/NO
4P neutral on left
4P + NC/NO

0165309NS
0165319NS
0165329NS
0165339NS

0168309NS
0168319NS
0168329NS
0168339NS

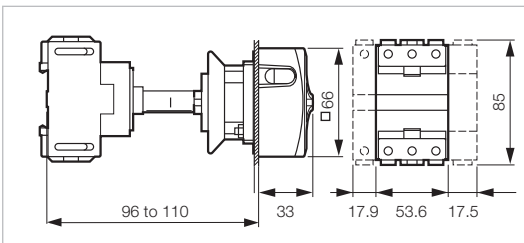

STANDARD VERSIONS IP40 RATED.

TO ORDER WITH IP65 GASKETS ADD -1 TO PART NUMBERS ABOVE.
IE. 0165209NS-1

COMPONENTS AND ACCESSORIES

Part Number



0172179

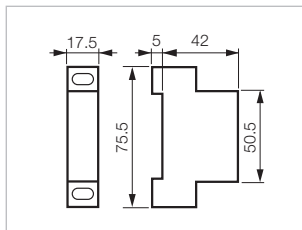

3-pole switch body without handle

50 A
63 A

0172200
0172300

Additional pole

50 A
63 A

0172275
0172375

Neutral pole

50 A
63 A

0172265
0172365

Junction block
Ground or Neutral

0172385

Auxiliary contact - 10A

NC/NO

0172179

IP65 Seal Kit

0174259

Replacement Handle, Plate, and Frame

- 66 - Yellow/Red
- 66 - Grey

0172601
0174601

50A / 63A

▶ DOOR INTERLOCK MOUNTING - SHORT METAL SHAFT EXTENSION



PADLOCKABLE PRESENTATION

Yellow/Red Handle
Part Number

Grey Handle
Part Number

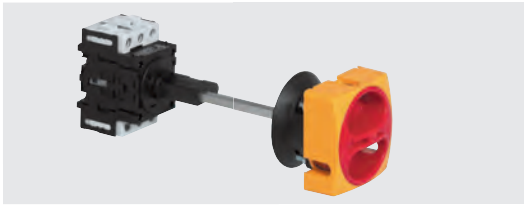

0165209SS

50 A

3P
3P + NC/NO
4P neutral on left
4P + NC/NO

0165209SS
0165219SS
0165229SS
0165239SS

0168209SS
0168219SS
0168229SS
0168239SS

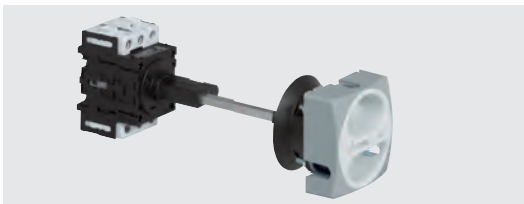

0168209SS

63 A

3P
3P + NC/NO
4P neutral on left
4P + NC/NO

0165309SS
0165319SS
0165329SS
0165339SS

0168309SS
0168319SS
0168329SS
0168339SS

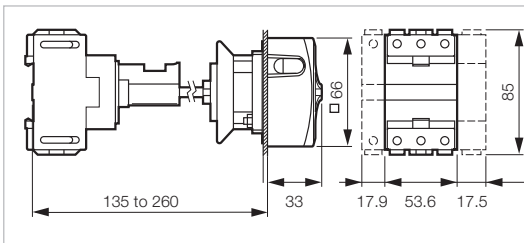

STANDARD VERSIONS IP40 RATED.

TO ORDER WITH IP65 GASKETS ADD -1 TO PART NUMBERS ABOVE.
IE. 0165209SS-1

COMPONENTS AND ACCESSORIES

Part Number



0172300

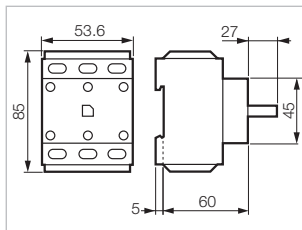

3-pole switch body without handle

50 A
63 A

0172200
0172300

Additional pole

50 A
63 A

0172275
0172375

Neutral pole

50 A
63 A

0172265
0172365

Junction block
Ground or Neutral

0172385

Auxiliary contact - 10A

NC/NO

0172179

IP65 Seal Kit

0174259

Replacement Handle

□ 66 - Yellow/Red
□ 66 - Grey

0172601
0174601



0172375

0172385

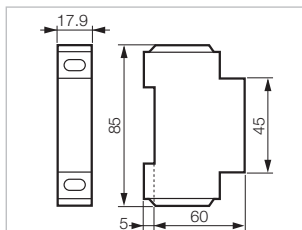

50A / 63A

▶ DOOR INTERLOCK MOUNTING - LONG METAL SHAFT EXTENSION



Technical Info (p.196)

PADLOCKABLE PRESENTATION

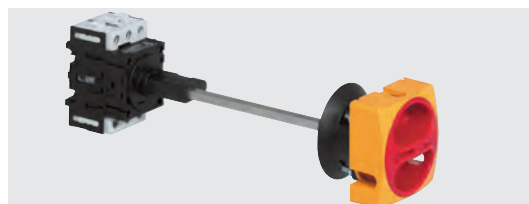

0165209LS

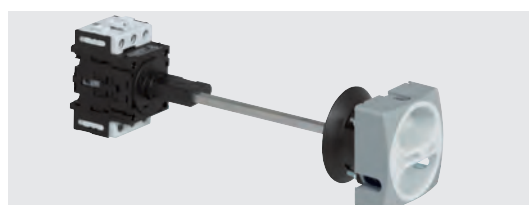

0168209LS

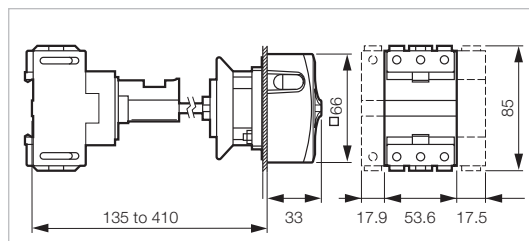

50 A

3P
3P + NC/NO
4P neutral on left
4P + NC/NO

Yellow/Red Handle
Part Number

0165209LS
0165219LS
0165229LS
0165239LS

Grey Handle
Part Number

0168209LS
0168219LS
0168229LS
0168239LS

63 A

3P
3P + NC/NO
4P neutral on left
4P + NC/NO

0165309LS
0165319LS
0165329LS
0165339LS

0168309LS
0168319LS
0168329LS
0168339LS

STANDARD VERSIONS IP40 RATED.

TO ORDER WITH IP65 GASKETS ADD -1 TO PART NUMBERS ABOVE.
IE. 0165209LS-1

COMPONENTS AND ACCESSORIES

Part Number



0172179

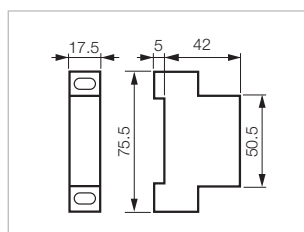

3-pole switch body without handle

50 A
63 A

0172200
0172300

Additional pole

50 A
63 A

0172275
0172375

Neutral pole

50 A
63 A

0172265
0172365

Junction block

Ground or Neutral

0172385

Auxiliary contact - 10A

NC/NO

0172179

IP65 Seal Kit

0174259

Replacement Handle

66 - Yellow/Red
 66 - Grey

0172601
0174601



0172395

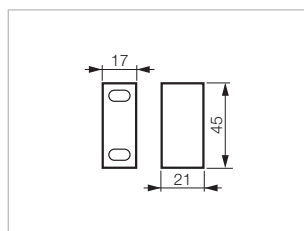

50A / 63A

ENCLOSURES

 Technical Info (p. 196)

PADLOCKABLE PRESENTATION



0172261

0174261

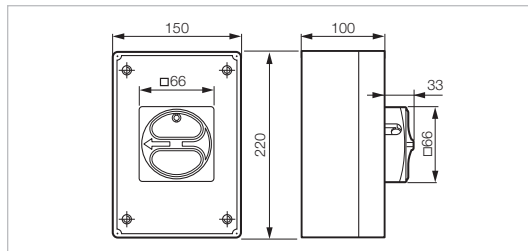

Cable entries: 4 x PG21

50 A

- 3P
- 3P + NC/NO
- 4P neutral on left
- 4P + NC/NO

Yellow/Red Handle
Part Number

- 0172261
- 0172271
- 0172281
- 0172291

Grey Handle
Part Number

- 0174261
- 0174271
- 0174281
- 0174291

63 A

- 3P
- 3P+NC/NO
- 4P neutral on left
- 4P + NC/NO

- 0172361
- 0172371
- 0172381
- 0172391

- 0174361
- 0174371
- 0174381
- 0174391

STANDARD VERSIONS IP40 RATED.

TO ORDER WITH IP65 GASKETS ADD -6 TO PART NUMBERS ABOVE.

IE. 0172261-6

PADLOCKABLE PRESENTATION



0172209

0174209

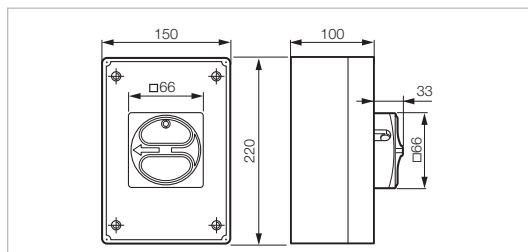

Cable entries: 4 x PG29

50 A

- 6P
- 6P + NC/NO

Yellow/Red Handle
Part Number

- 0172209
- 0172229

Grey Handle
Part Number

- 0174209
- 0174229

63 A

- 6P
- 6P+NC/NO

- 0172309
- 0172329

- 0174309
- 0174329

STANDARD VERSIONS IP40 RATED.

TO ORDER WITH IP65 GASKETS ADD -6 TO PART NUMBERS ABOVE.

IE. 0172209-6

CABLE GLANDS



PG21-GY

- PG21
- PG29

- Cable Range 13mm - 18mm
- Cable Range 18mm - 25mm

Part Number

- PG21-GY
- PG29-GY

50A / 63A

ENCLOSURES

 Technical Info (p.196)

NON- PADLOCKABLE PRESENTATION



0172262

0174262

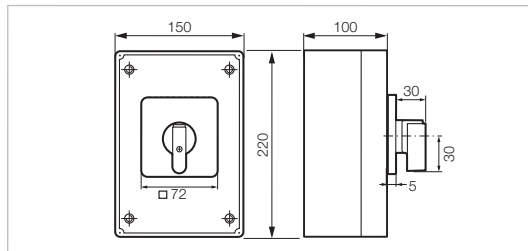

Cable entries: 4 x PG21

50 A

- 3P
- 3P + NC/NO
- 4P neutral on left
- 4P + NC/NO

Yellow/Red Handle
Part Number

- 0172262
- 0172272
- 0172282
- 0172292

Grey Handle
Part Number

- 0174262
- 0174272
- 0174282
- 0174292

63 A

- 3P
- 3P+NC/NO
- 4P neutral on left
- 4P + NC/NO

- 0172362
- 0172372
- 0172382
- 0172392

- 0174362
- 0174372
- 0174382
- 0174392

STANDARD VERSIONS IP40 RATED.

TO ORDER WITH IP65 GASKETS ADD -6 TO PART NUMBERS ABOVE.
IE. 0172262-6

NON- PADLOCKABLE PRESENTATION



0172219

0174219

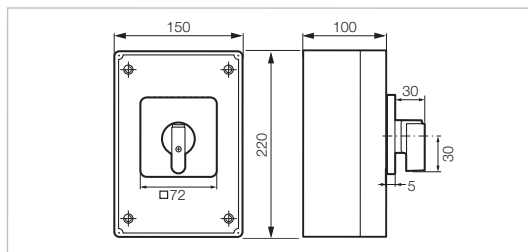

Cable entries: 4 x PG29

50 A

- 6P
- 6P + NC/NO

Yellow/Red Handle
Part Number

- 0172219
- 0172239

Grey Handle
Part Number

- 0174219
- 0174239

63 A

- 6P
- 6P+NC/NO

- 0172319
- 0172339

- 0174319
- 0174339

STANDARD VERSIONS IP40 RATED.

TO ORDER WITH IP65 GASKETS ADD -6 TO PART NUMBERS ABOVE.
IE. 0172219-6

CABLE GLANDS



PG21-GY

- PG21
- PG29

- Cable Range 13mm - 18mm
- Cable Range 18mm - 25mm

Part Number

- PG21-GY
- PG29-GY

50A / 63A

► BLOCKS

 Technical Info (p.196)

Part Number



0172300

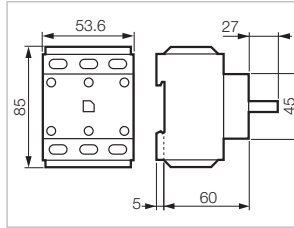

3-pole body switch without presentation

50 A
63 A

0172200
0172300



0172375

0172385

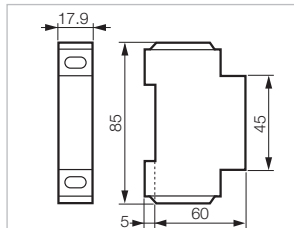

Additional pole
(for use in enclosure only)

50 A
63 A

0172275
0172375

Neutral pole

50 A
63 A

0172265
0172365

Junction block

Ground or Neutral

0172385



0172179

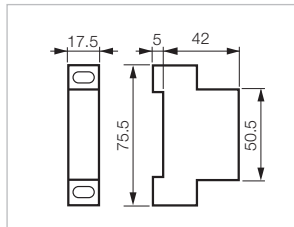

Auxiliary contact - 10A

NC/NO

1 pole early break

0172179

0172395



0172395

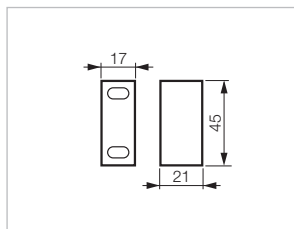

50A / 63A

► HANDLES

 Technical Info (p. 196)

Part Number



0172601

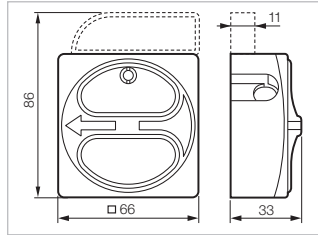

Padlockable presentation
Padlock: \varnothing 6 to 8 mm

- 66 - Yellow/Red
- 66 - Grey

0172601
0174601



0172612

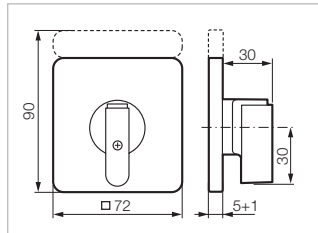

With plate, frame and handle

- 72 - Yellow/Red
- 72 - Grey

0172612
0174612

► EMPTY ENCLOSURES

WITHOUT HANDLE



0172569

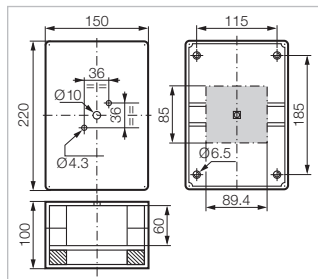

Grey - Up to 4 poles + auxiliary contact
220 x 150 x 100 mm
Cable entries: 4 x PG21

0172569



0172579

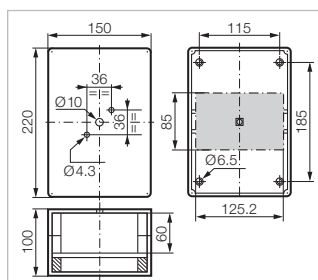







Grey - Up to 6 poles + auxiliary contact
220 x 150 x 100 mm
Cable entries: 4 x PG29

0172579

50A / 63A

▶ ACCESSORIES

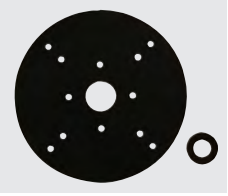
 Technical Info (p. 196)

		Part Number
		
0172367	Terminal covers	
	For 3-pole switch	0172367
	For additional pole, neutral pole or junction block	0172377
	For NC/NO auxiliary contact (pair)	0172189
	For early break auxiliary contact	0172199
		
0172649	Duty labels	
	Blank	0172629
	Engraved INTER PRINCIPAL	0172639
	Engraved MAIN SWITCH	0172649
		
0174189	Kit for clutch drive presentation	
	Short shaft without door interlock	0174189
	Long shaft without door interlock	0174199
	Without shaft and without door interlock	0174179
		
0174179	kit for door interlock	0174249
		
0174249	IP 65 seal kit	
	For front mounting switches and enclosures	
	Padlockable <input type="checkbox"/> 66 or plate and frame <input type="checkbox"/> 64 or <input type="checkbox"/> 72	0172267
	For rear mounting with clutch drive	
	Padlockable <input type="checkbox"/> 66 or plate and frame <input type="checkbox"/> 64 or <input type="checkbox"/> 72	0174259
		
0172267	Cable Glands	
	PG21	Cable Range 13mm - 18mm
	PG29	Cable Range 18mm - 25mm
		
0174259		PG21-GY
		PG29-GY
		
PG21-GY		

80A / 100A

▶ DOOR/PANEL MOUNTING

 Technical Info (p. 196)

PADLOCKABLE PRESENTATION



0172401



0174501

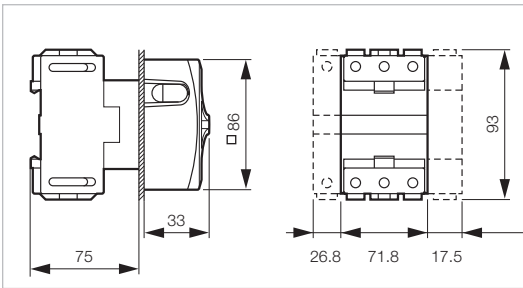

80 A

- 3P
- 3P + NC/NO
- 4P neutral on left
- 4P + NC/NO

Yellow/Red Handle
Part Number

- 0172401
- 0172411
- 0172421
- 0172431

Grey Handle
Part Number

- 0174401
- 0174411
- 0174421
- 0174431

100 A

- 3P
- 3P+NC/NO
- 4P neutral on left
- 4P + NC/NO

- 0172501
- 0172511
- 0172521
- 0172531

- 0174501
- 0174511
- 0174521
- 0174531

STANDARD VERSIONS IP40 RATED.
TO ORDER WITH IP65 GASKETS ADD -1 TO PART NUMBERS ABOVE.
IE. 0172401-1

COMPONENTS AND ACCESSORIES

Part Number



0172400

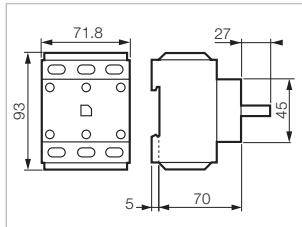

3-pole switch body without handle

- 80 A
- 100 A

- 0172400
- 0172500

Additional pole

- 80 A
- 100 A

- 0172475
- 0172575

Neutral pole

- 80 A
- 100 A

- 0172465
- 0172565

Junction block Ground or Neutral

0172585

Auxiliary contact - 10A

NC/NO

0172179

IP65 Seal Kit

0172277

Replacement Handle

- 86 - Yellow/Red
- 86 - Grey

- 0172621
- 0174621



0172475

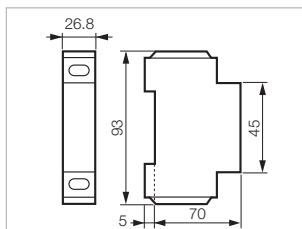

80A / 100A

▶ DOOR/PANEL MOUNTING

 Technical Info (p. 196)

NON- PADLOCKABLE PRESENTATION

Yellow/Red Handle
Part Number

Grey Handle
Part Number



0172402



0174502

80 A

- 3P
- 3P + NC/NO
- 4P neutral on left
- 4P + NC/NO

- 0172402
- 0172412
- 0172422
- 0172432

- 0174402
- 0174412
- 0174422
- 0174432

100 A

- 3P
- 3P + NC/NO
- 4P neutral on left
- 4P + NC/NO

- 0172502
- 0172512
- 0172522
- 0172532

- 0174502
- 0174512
- 0174522
- 0174532

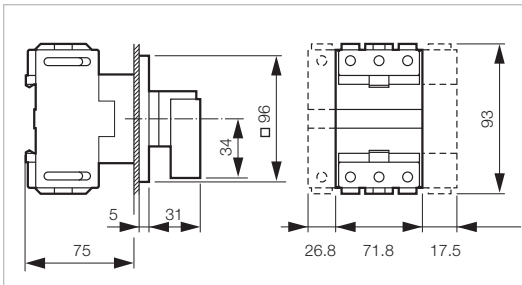

STANDARD VERSIONS IP40 RATED.

TO ORDER WITH IP65 GASKETS ADD -1 TO PART NUMBERS ABOVE.
IE. 0172402-1

COMPONENTS AND ACCESSORIES

Part Number



0172400

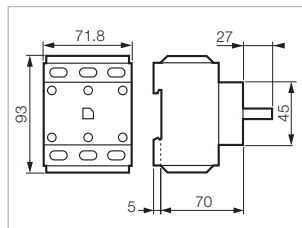

3-pole switch body without handle

- 80 A
- 100 A

- 0172400
- 0172500

Additional pole

- 80 A
- 100 A

- 0172475
- 0172575

Neutral pole

- 80 A
- 100 A

- 0172465
- 0172565

Junction block Ground or Neutral

- 0172585

Auxiliary contact - 10A

- NC/NO

- 0172179

IP65 Seal Kit

- 0172277

Replacement Handle

- g6 - Yellow/Red
- g6 - Grey

- 0172622
- 0174622



0172475

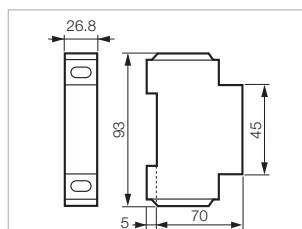

80A / 100A

► DIN-RAIL IN-PANEL MOUNTING



Technical Info (p. 196)

PADLOCKABLE PRESENTATION

Grey Handle
Part Number



0174405

80 A

- 3P
- 3P + NC/NO
- 4P neutral on left
- 4P + NC/NO

- 0174405
- 0174415
- 0174425
- 0174435

100 A

- 3P
- 3P+NC/NO
- 4P neutral on left
- 4P + NC/NO

- 0174505
- 0174515
- 0174525
- 0174535

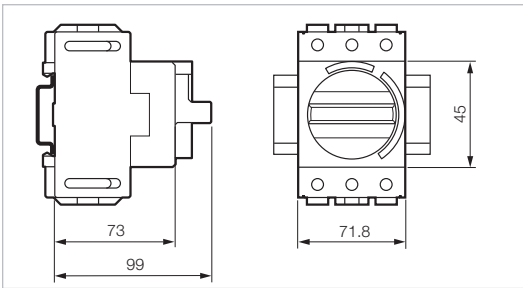

COMPONENTS AND ACCESSORIES

Part Number



0172179

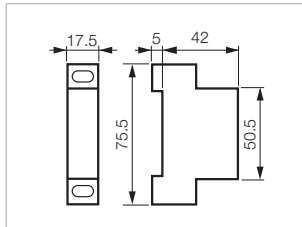

3-pole switch body without handle

- 80 A
- 100 A

- 0172400
- 0172500

Additional pole

- 80 A
- 100 A

- 0172475
- 0172575

Neutral pole

- 80 A
- 100 A

- 0172465
- 0172565

Junction block

Ground or Neutral

0172585

Auxiliary contact - 10A

NC/NO

0172179

80A / 100A

▶ DOOR INTERLOCK MOUNTING - NO METAL SHAFT EXTENSION

 Technical Info (p.196)

PADLOCKABLE PRESENTATION

Yellow/Red Handle
Part Number

Grey Handle
Part Number

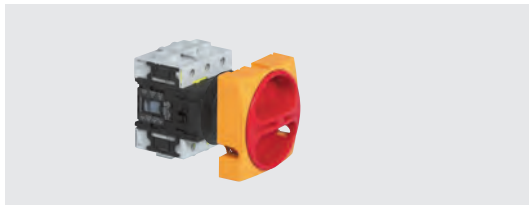

0165409NS

80 A

- 3P
- 3P + NC/NO
- 4P neutral on left
- 4P + NC/NO

- 0165409NS
- 0165419NS
- 0165429NS
- 0165439NS

- 0168409NS
- 0168419NS
- 0168429NS
- 0168439NS

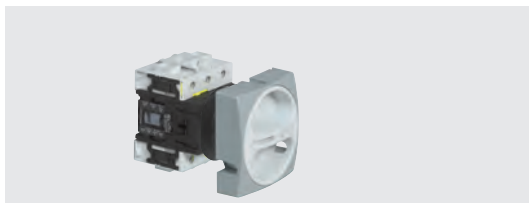

0168509NS

100 A

- 3P
- 3P + NC/NO
- 4P neutral on left
- 4P + NC/NO

- 0165509NS
- 0165519NS
- 0165529NS
- 0165539NS

- 0168509NS
- 0168519NS
- 0168529NS
- 0168539NS

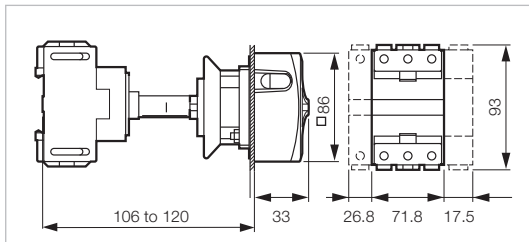

STANDARD VERSIONS IP40 RATED.
TO ORDER WITH IP65 GASKETS ADD -1 TO PART NUMBERS ABOVE.
IE. 0165409NS-1

COMPONENTS AND ACCESSORIES

Part Number



0172400

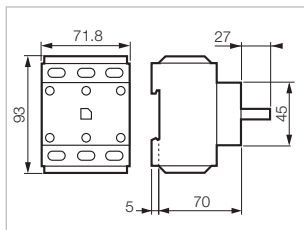

3-pole switch body without handle

- 80 A
- 100 A

- 0172400
- 0172500

Additional pole

- 80 A
- 100 A

- 0172475
- 0172575

Neutral pole

- 80 A
- 100 A

- 0172465
- 0172565

Junction block
Ground or Neutral

- 0172585

Auxiliary contact - 10A

- NC/NO

- 0172179

IP65 Seal Kit

- 0174269

Replacement Handle

- 86 - Yellow/Red
- 86 - Grey

- 0172621
- 0174621



0172475

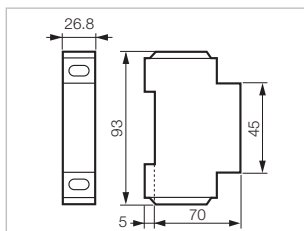

80A / 100A

▶ DOOR INTERLOCK MOUNTING - SHORT METAL SHAFT EXTENSION



Technical Info (p.196)

PADLOCKABLE PRESENTATION

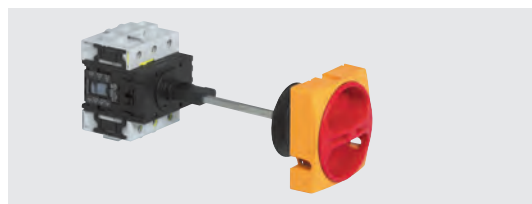

0165409SS

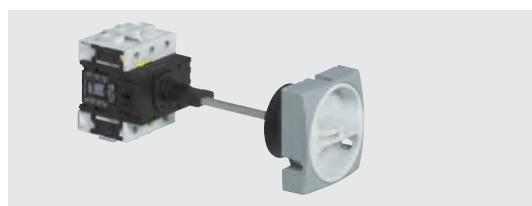

0168509SS

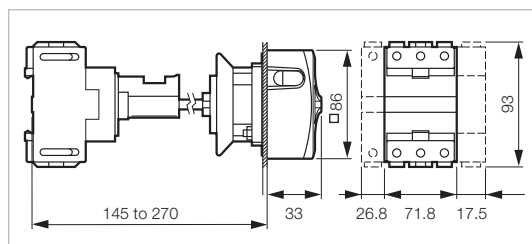

80 A

- 3P
- 3P + NC/NO
- 4P neutral on left
- 4P + NC/NO

- 0165409SS
- 0165419SS
- 0165429SS
- 0165439SS

- 0168409SS
- 0168419SS
- 0168429SS
- 0168439SS

100 A

- 3P
- 3P + NC/NO
- 4P neutral on left
- 4P + NC/NO

- 0165509SS
- 0165519SS
- 0165529SS
- 0165539SS

- 0168509SS
- 0168519SS
- 0168529SS
- 0168539SS

STANDARD VERSIONS IP40 RATED.

TO ORDER WITH IP65 GASKETS ADD -1 TO PART NUMBERS ABOVE.
IE. 0165409SS-1

COMPONENTS AND ACCESSORIES



0172179

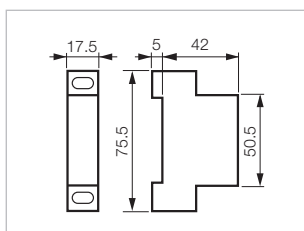

3-pole switch body without handle

- 80 A
- 100 A

- 0172400
- 0172500

Additional pole

- 80 A
- 100 A

- 0172475
- 0172575

Neutral pole

- 80 A
- 100 A

- 0172465
- 0172565

Junction block

Ground or Neutral

- 0172585

Auxiliary contact - 10A

NC/NO

- 0172179

IP65 Seal Kit

- 0174269

Replacement Handle

- 86 - Yellow/Red
- 86 - Grey

- 0172621
- 0174621

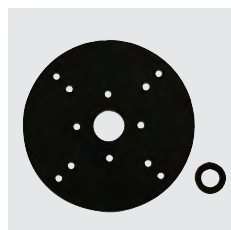

0174269

80A / 100A

▶ DOOR INTERLOCK MOUNTING - LONG METAL SHAFT EXTENSION



Technical Info (p.196)

PADLOCKABLE PRESENTATION

Yellow/Red Handle
Part Number

Grey Handle
Part Number

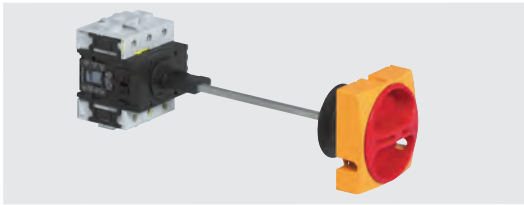

0165409LS

80 A

3P
3P + NC/NO
4P neutral on left
4P + NC/NO

0165409LS
0165419LS
0165429LS
0165439LS

0168409LS
0168419LS
0168429LS
0168439LS

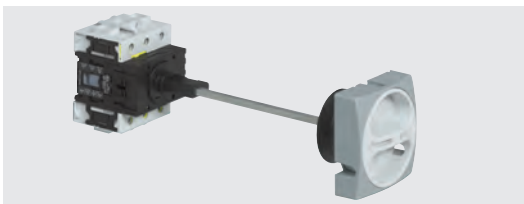

0168509LS

100 A

3P
3P + NC/NO
4P neutral on left
4P + NC/NO

0165509LS
0165519LS
0165529LS
0165539LS

0168509LS
0168519LS
0168529LS
0168539LS

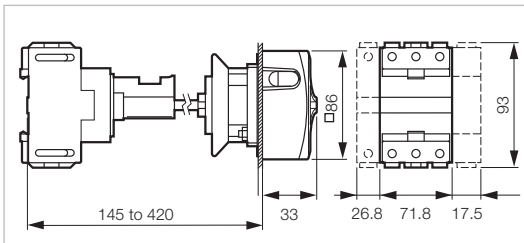

STANDARD VERSIONS IP40 RATED.

TO ORDER WITH IP65 GASKETS ADD -1 TO PART NUMBERS ABOVE.
IE. 0165409LS-1

COMPONENTS AND ACCESSORIES

Part Number



0172400

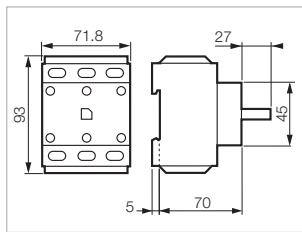

3-pole switch body without handle

80 A
100 A

0172400
0172500

Additional pole

80 A
100 A

0172475
0172575

Neutral pole

80 A
100 A

0172465
0172565

Junction block
Ground or Neutral

0172585

Auxiliary contact

NC/NO

0172179

IP65 Seal Kit

0174269

Replacement Handle

- 86 - Yellow/Red
- 86 - Grey

0172621
0174621



0172475

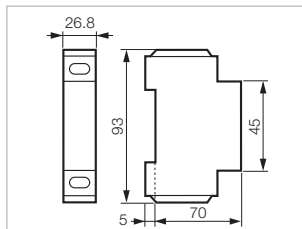

80A / 100A

► ENCLOSURES

 Technical Info (p.196)

PADLOCKABLE PRESENTATION



0172461

0174561

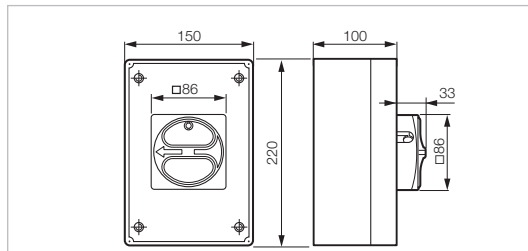

Cable entries: 4 x PG29

80 A

	Yellow/Red Handle Part Number	Grey Handle Part Number
3P	0172461	0174461
3P + NC/NO	0172471	0174471
4P neutral on left	0172481	0174481
4P + NC/NO	0172491	0174491

100 A

3P	0172561	0174561
3P+NC/NO	0172571	0174571
4P neutral on left	0172581	0174581
4P + NC/NO	0172591	0174591

STANDARD VERSIONS IP40 RATED.

TO ORDER WITH IP65 GASKETS ADD -6 TO PART NUMBERS ABOVE.

IE. 0172461-6

PADLOCKABLE PRESENTATION



0172409

0174509

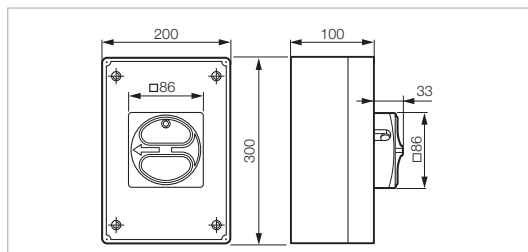

Cable entries: 4 x PG29 and 4 x PG21

80 A

6P	0172409	0174409
6P + NC/NO	0172429	0174429

100 A

6P	0172509	0174509
6P+NC/NO	0172529	0174529

STANDARD VERSIONS IP40 RATED.

TO ORDER WITH IP65 GASKETS ADD -6 TO PART NUMBERS ABOVE.

IE. 0172409-6

CABLE GLANDS



PG21-GY

		Part Number
PG21	Cable Range 13mm - 18mm	PG21-GY
PG29	Cable Range 18mm - 25mm	PG29-GY

80A / 100A

ENCLOSURES

 Technical Info (p.196)

NON- PADLOCKABLE PRESENTATION



0172462

0174562

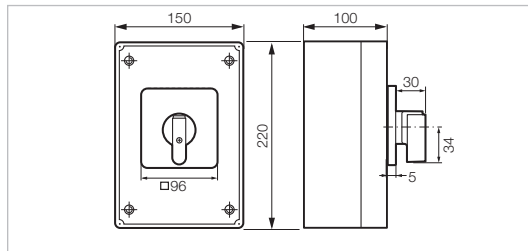

Cable entries: 4 x PG29

80 A

	Yellow/Red Handle Part Number	Grey Handle Part Number
3P	0172462	0174462
3P + NC/NO	0172472	0174472
4P neutral on left	0172482	0174482
4P + NC/NO	0172492	0174492

100 A

3P	0172562	0174562
3P+NC/NO	0172572	0174572
4P neutral on left	0172582	0174582
4P + NC/NO	0172592	0174592

**STANDARD VERSIONS IP40 RATED.
TO ORDER WITH IP65 GASKETS ADD -6 TO PART NUMBERS ABOVE.
IE. 0172462-6**

NON- PADLOCKABLE PRESENTATION



0172419

0174519

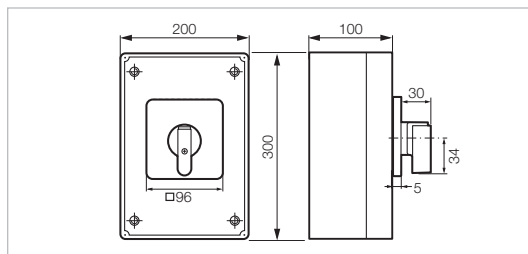

Cable entries: 4 x PG29 and 4 x PG21

80 A

6P	0172419	0174419
6P + NC/NO	0172439	0174439

100 A

6P	0172519	0174519
6P+NC/NO	0172539	0174539

**STANDARD VERSIONS IP40 RATED.
TO ORDER WITH IP65 GASKETS ADD -6 TO PART NUMBERS ABOVE.
IE. 0172419-6**

CABLE GLANDS



PG21-GY

		Part Number
PG21	Cable Range 13mm - 18mm	PG21-GY
PG29	Cable Range 18mm - 25mm	PG29-GY

80A / 100A

► BLOCKS

 Technical Info (p.196)

Part Number

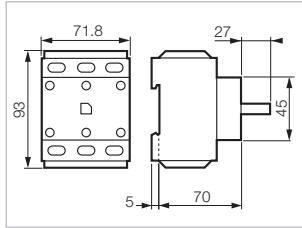

3-pole body switch without presentation

80 A
100 A

0172400
0172500

0172400



Additional pole
(for use in enclosure only)

80 A
100 A

0172475
0172575

0172475

0172465

Neutral pole

80 A
100 A

0172465
0172565

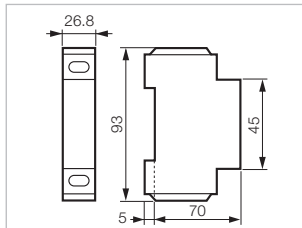

Junction block
Ground or Neutral

0172585

0172585

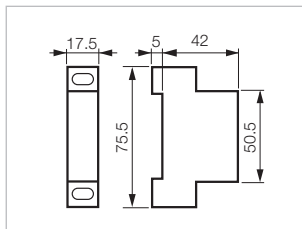

Auxiliary contact - 10A

NC/NO

0172179

1 pole early break

0172595

0172179

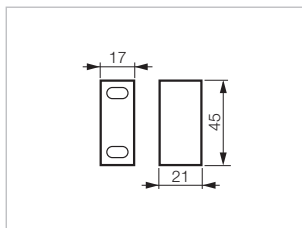

0172595

80A / 100A

► HANDLES

 Technical Info (p.196)

Part Number



0172621

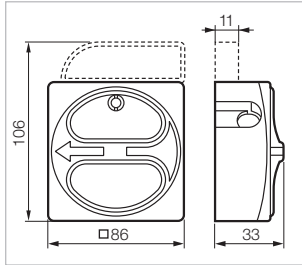

Padlockable presentation

Padlock: \varnothing 6 to 8 mm

- 86 - Yellow/Red
- 86 - Grey

0172621
0174621



0172622

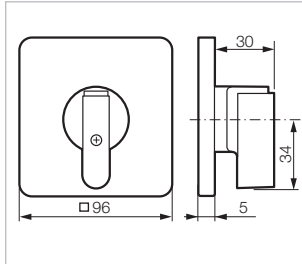

With plate, frame and handle

- 96 - Yellow/Red
- 96 - Grey

0172622
0174622

► EMPTY ENCLOSURES

WITHOUT HANDLE



0172589

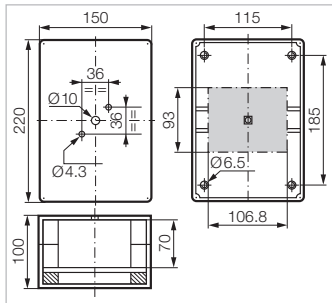

Grey - Up to 3 poles + auxiliary contact
220 x 150 x 100 mm
Cable entries: 4 x PG29

0172589



0172599

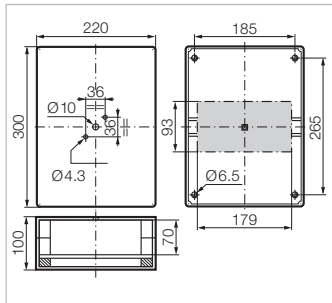







Grey - Up to 6 poles + auxiliary contact
300 x 200 x 100 mm
Cable entries: 4 x PG29 and 4 x PG21

0172599

80A / 100A

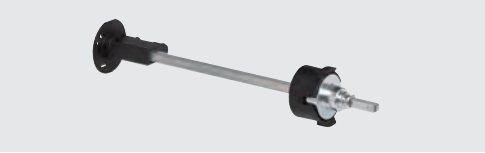
▶ ACCESSORIES

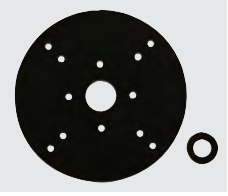
 Technical Info (p. 196)

		Part Number
 0172567	Terminal covers	
	For 3-pole body switch	0172567
	For additional pole, neutral pole or junction block	0172577
	For NC/NO auxiliary contact (pair)	0172189
	For early break auxiliary contact	0172199
 0172649	Duty labels	
	Blank	0172629
	Engraved MAIN SWITCH	0172649
 0174189	Kit for clutch drive presentation	
	Short shaft without door interlock	0174189
	Long shaft without door interlock	0174199
	Without shaft and without door interlock	0174179
 0174179	Kit for door interlock	
		0174249
 0174249	IP 65 seal kit	
	For front mounting switches and enclosures	
	Padlockable <input type="checkbox"/> 86 or plate and frame <input type="checkbox"/> 96	0172277
	For rear mounting with clutch drive	
	Padlockable <input type="checkbox"/> 86 or plate and frame <input type="checkbox"/> 96	0174269
 0172277	Cable Glands	
	PG21	Cable Range 13mm - 18mm
 0174269	PG29	Cable Range 18mm - 25mm
		PG21-GY
 PG21-GY		PG29-GY

Enclosure Selection Guide

► 25A / 32A



Example: switch disconnecter 32 A
Enclosed 4 poles,
padlockable presentation

Enclosure 150 x 100 x 96 mm

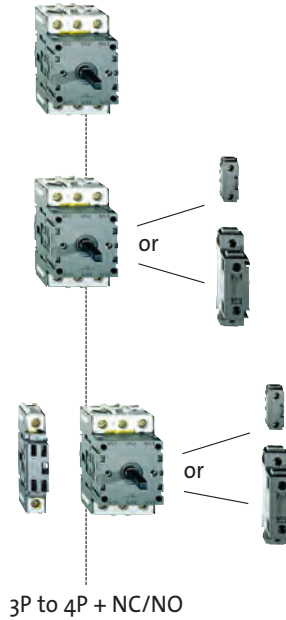

Enclosure 220 x 150 x 100 mm

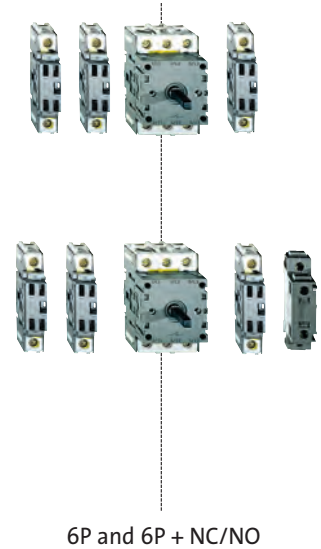

► 50A / 63A



Example: switch disconnecter 50 A
Enclosed 6 poles,
Plate, frame and handle presentation

Enclosure 220 x 150 x 100mm

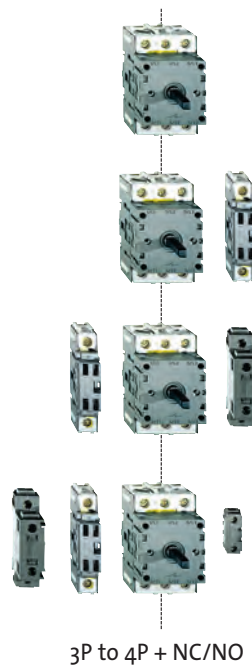

Enclosure 220 x 150 x 100 mm

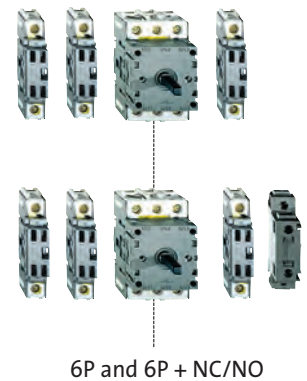

Enclosure Selection Guide

▶ 80A / 100A

Enclosure 220 x 150 x 100 mm

Enclosure 300 x 220 x 100 mm



Example: switch disconnector 100 A
Enclosed 4 poles,
padlockable presentation

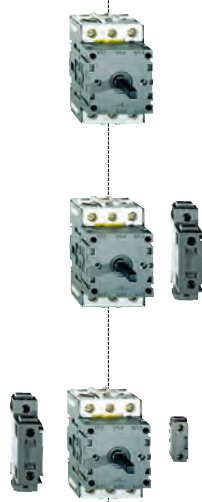

3P and 3P + NC/NO

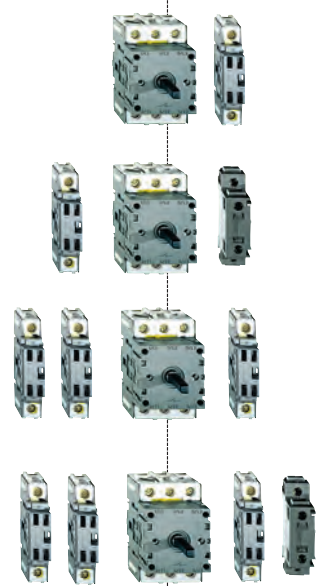

4P and 6P + NC/NO

LEGEND



basic 3-pole block



additional pole
additional neutral pole
junction block



Auxiliary contact NC/NO



early break auxiliary contact

Technical Specifications

▶ GENERAL

Characteristics	25 A	32 A	50 A	63 A	80 A	100 A
UL/cUL - suitable as motor disconnect						
▶ Rated voltage (V)	600	600	600	600	600	600
▶ General Use Current (A)	25	32	50	63	80	100
▶ Motor Ratings (hp)						
1 x 120 V	0.75	1	1.5	3	3	5
1 x 240 V	1.5	2	3	5	10	10
1 x 277 V	2	3	5	7.5	10	15
3 x 120 V	1.5	2	3	5	7.5	10
3 x 240 V	3	5	7.5	10	20	25
3 x 480 V	7.5	10	15	20	40	50
3 x 600 V	7.5	10	15	20	40	50
▶ Auxiliary Blocks						
NO/NC	A600					
Early Make	B300					
Early Break	B300					
▶ Wire Guage (AWG)						
3-Pole Body, Additional Pole, Late Break Neutral, Junction Block	8 - 14	8 - 14	4 - 14	4 - 14	1 - 14	1 - 14
Auxiliary Contacts	14 - 18	14 - 18	14 - 18	14 - 18	14 - 18	14 - 18
▶ Short Circuit Rating						
Fuse Type K5 (A)	5000	5000	5000	5000	5000	10000
Fuse Size (A)	40	40	80	80	125	125
Rated break capacity	330	330	800	800	800	800

Technical Specifications

▶ GENERAL

Characteristics	25 A	32 A	50 A	63 A	80 A	100 A
IEC						
▶ Rated insulation voltage U_i (V)	690	690	690	690	690	690
▶ Conventional free air thermal current I_{th} Uninterrupted rated current I_u (A)	25	32	50	63	80	100
▶ Conventional enclosed thermal current I_{the} (A)	20	25	40	50	63	80
▶ Rated impulse withstand voltage (overvoltage category III - pollution degree 3 U_{imp} (kV)	6	6	6	6	6	6
▶ Rated operating current I_e (A) AC - 21 A/22 A Conform to IEC 60947-3	25	32	50	63	80	100
▶ Rated operating power (kW)						
AC 23 A						
3 x 230 V	5.5	5.5	15	15	18.5	22
3 x 400 V	7.5	11	18.5	22	30	37
3 x 500 V	7.5	11	22	30	37	45
3 x 690 V	7.5	11	18.5	22	22	30
AC 3						
3 x 230 V	4	4	7.5	11	15	18.5
3 x 400 V	5.5	7.5	15	18.5	22	30
3 x 500 V	5.5	7.5	15	22	30	37
3 x 690 V	5.5	7.5	15	18.5	18.5	22
▶ Make - break characteristics ($I_{eff}/400$ V)						
Rated make capacity	710	710	1270	1270	1970	1970
Rated break capacity	330	330	800	800	800	800
▶ Short circuit characteristics						
Rated short term withstand current I_{cW} ($I_{eff}/400$ V/1 s)	350	430	500	760	1100	1500
Rated short circuit make capacity I_{cm} (kA peak/400 V)	1	1	1.8	1.8	2.8	2.8
Short circuit current (kA $I_{eff}/400$ V)	10	10	10	10	10	10
with fuse gI/gG (A)	25	32	50	63	80	100

Technical Specifications

▶ GENERAL

Characteristics	25 A	32 A	50 A	63 A	80 A	100 A
▶ Mechanical life AC 20 (million)	0.1	0.1	0.04	0.04	0.04	0.04
▶ Connections						
Stranded wire + (min/max) cap (mm ²)	0.75/6	0.75/6	1.5/16	1.5/16	2.5/35	2.5/35
Solid wire (mm ²)	10	10	25	25	50	50
▶ Operating and Storage temperature	-30°C to +70 °C , -22°F to +158°F					
▶ Protection rating	rear of panel: IPxxB front of panel IP 40 in standard version (IP 65 on request)					
▶ Conformity to standards	IEC 60697-3 -EN 60 947-3, UL508, CSA22.2, CB Certificate					
▶ Climatic resistance Tropical atmosphere according to	IEC 60068-2-30 Cyclic damp heat					

▶ AUXILIARY CONTACTS

Characteristics	25 A	32 A	50 A	63 A	80 A	100 A
▶ Rated insulation voltage Ui (V)	400	400	400	400	400	400
▶ Conventional free air thermal current I _{th}						
Continuous rated current I _u (A)	10	10	10	10	10	10
▶ Rated operating current I _e (A)						
AC 15						
230 V	6	6	6	6	6	6
400 V	4	4	4	4	4	4
▶ PROTECTION AGAINST SHORT CIRCUIT BY FUSE GG (A)	10	10	10	10	10	10
▶ Max. connection stranded wire (mm ²)	2 x 2.5	2 x 2.5	2 x 2.5	2 x 2.5	2 x 2.5	2 x 2.5

Technical Specifications

► ENCLOSURES

Characteristics	150x100x96	220x150x100	220x150x100	220x150x100	220x150x100	300x200x100
► Rating	25 and 32 A 3P to 4P +NC/NO	25 and 32 A 6P and 6P +NC/NO	50 and 63 A 3P to 4P +NC/NO	50 and 63 A 6P and 6P +NC/NO	80 and 100 A 3P and 3P +NC/NO	80 and 100 A 4P to 6P +NC/NO
► Cable inputs	2 x 2 PG 16 OR 2 x 2 M25	2 x 2 PG 21	2 x 2 PG 21	2 x 2 PG 29	2 x 2 PG 29	2 x 2 PG 21 2 x 2 PG 29
► Ø knockouts (mm)	PG 16: 22.5 ISO M25: 25	28.5	28.5	37.5	37.5	37.5 and 28.5
► No. of knockouts (top and bottom)	2	2	2	2	2	4
► Panel mount	by 2 screws	by 4 screws	by 4 screws	by 4 screws	by 4 screws	by 4 screws
► Base/cover assembly	by 1 screws self-tapping stainless steel	by 4 screws self-tapping stainless steel	by 4 screws self-tapping stainless steel	by 4 screws self-tapping stainless steel	by 4 screws self-tapping stainless steel	by 6 screws self-tapping stainless steel
► Switch/base assembly	on 35 mm DIN rail (this rail is notched for positioning the switch)					
► Handles mounting	screwing on shaft pre-pierced cover					
► Insulation	Class II installed (provided that the correct insulation plugs are used with the enclosure)					
► Impact withstand	IK07					
► Flameproof	650°C					
► Protection rating	IP 66	IP 40 (IP 65 upon request)				

► Contact operating diagram

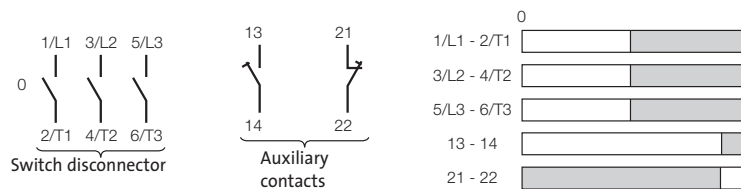

► Switch padlocking

In general: up to 3 padlocks \varnothing 4 to 8 mm
 Switch with 1 auxiliary contact NC/NO: up to 3 padlocks \varnothing 6 to 8 mm
 Modular presentation: 1 padlock \varnothing 6 to 8 mm

Technical Specifications

► MOUNTING - PANEL DRILLING

Panel/Door Handle Mounting

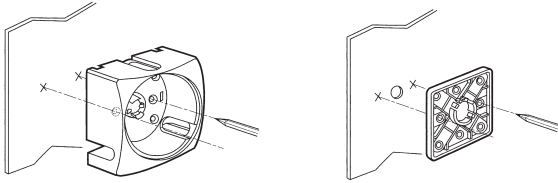

25A/32A

50A/63A/80A/100A

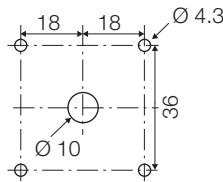
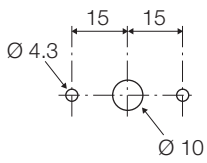

Ø22 Single Hole Mounting

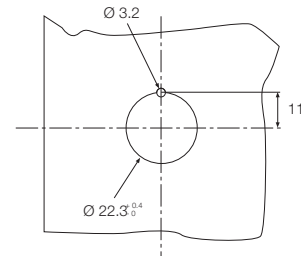

Door Interlock System

Short or Long Metal Shaft Version

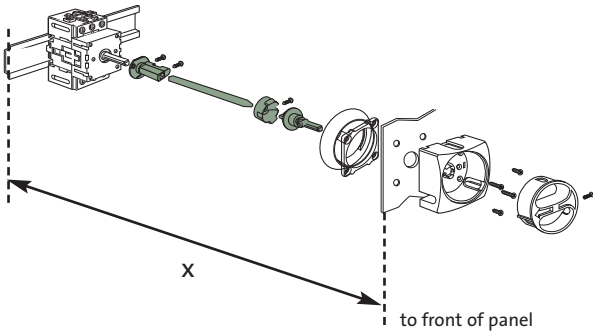

No Metal Shaft Version

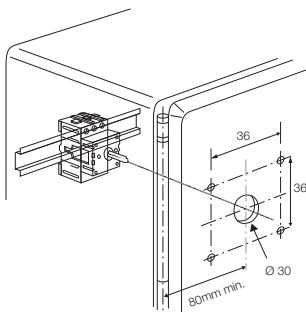
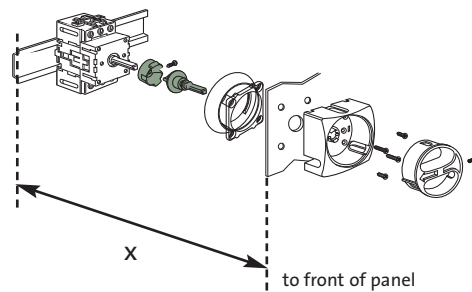

Minimum Distance to Hinge

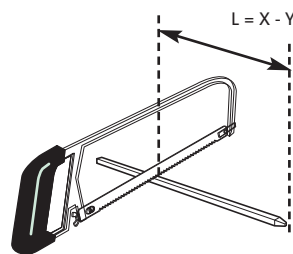

	X			Y
	without shaft	with short shaft	with long shaft	
25A / 32A	86 - 100 mm	125 - 250 mm	125 - 400 mm	92 mm
50A / 63A	96 - 110 mm	135 - 260 mm	135 - 410 mm	102 mm
80A / 100A	106 - 120 mm	145 - 270 mm	145 - 420 mm	112 mm