



Technical catalogue - Edition 2014.12

SACE Emax 2

New low voltage power circuit breakers to ANSI C37 / UL 1066 standards

Index

[Main characteristics](#)

1

[The ranges](#)

2

[Protection trip units](#)

3

[Communication devices and systems](#)

4

[Accessories](#)

5

[Installation](#)

6

[Overall dimensions](#)

7

[Wiring diagrams](#)

8

[Ordering codes](#)

9

SACE Emax 2

Consultation guide



Chapter 1

Main characteristics

Overview of the SACE Emax 2 family, distinctive features of the series, product conformity and service.

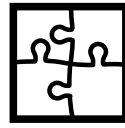

Chapter 5

Accessories

Accessories for SACE Emax 2 circuit breakers (signaling, control, interlocks, etc..) and for Ekip protection trip units (connectivity, measurements, protection, etc).

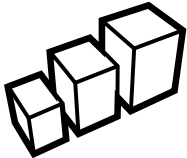

Chapter 2

The ranges

Electrical characteristics of automatic circuit breakers and switch disconnectors.



Chapter 6

Installation

Installation and circuit breaker performance in switchgear, installation environment, degree of protection and limiting curves.

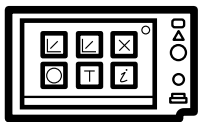

Chapter 3

Protection trip units

Latest generation Ekip protection trip units for power distribution, generator protection and power control.

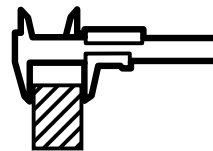

Chapter 7

Overall dimensions

Overall dimensions for fixed circuit breakers, drawout circuit breakers and accessories.



Chapter 4

Communication devices and systems

Supervision, Energy Management and complete integration in the systems with the possibility of communicating with all the main protocols used in the industrial sector.

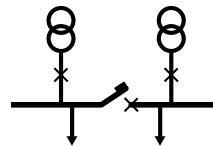

Chapter 8

Wiring diagrams

Circuit breaker and accessory wiring diagrams.



Chapter 9

Ordering codes

Ordering codes with configuration examples.

Main characteristics

Overview of the SACE Emax 2 family

Guide to selection	1/2
--------------------	-----

Distinctive features of the series

Efficiency	1/3
Control	1/4
Connectivity	1/5
Performance	1/6
Ease of use and safety	1/7

Product conformity

Approvals and certifications	1/9
Quality and Sustainability	1/10

ABB SACE Global Service	1/12
--------------------------------	-------------

Overview of the SACE Emax 2 family

1

Guide to selection

UL 1066 Automatic circuit breakers

IR @ 508VAC	Versione	800	1200	1600	2000	2500	3200	4000	5000	6000	
200	X-A	E4.2							E6.2		
125/150	L-A	E4.2							E6.2		
100	V-A	E2.2				E4.2			E6.2		
85	H-A	E2.2				E4.2			E6.2		
65	S-A	E1.2		E2.2			E4.2			E6.2	
50	N-A	E1.2		E2.2			E4.2			E6.2	
42	B-A	E1.2		E2.2			E4.2			E6.2	

UL 1066 Switch disconnectors

Withstand	Version	800	1200	1600	2000	2500	3200	4000	5000	6000	
50/100	X-A	E4.2							E6.2		
100	L-A	E4.2							E6.2		
85	V-A	E2.2				E4.2			E6.2		
65	S-A	E1.2		E2.2			E4.2			E6.2	
50	N-A	E1.2		E2.2			E4.2			E6.2	
42	B-A	E1.2		E2.2			E4.2			E6.2	

Protection trip units

Version	Application		
	Distribution	Power control	Generators
Ekip Dip	Protection	-	-
Ekip Touch	Protection and Measurement	Protection, Measurement and Load control	-
Ekip Hi-Touch	Protection, Measurement and Network Analyzer	Protection, Measurement, Network Analyzer and Load control	-
Ekip G Touch	-	Protection, Measurement and Load control	Protection and Measurement
Ekip G Hi-Touch	-	Protection, Measurement, Network Analyzer and Load control	Protection, Measurements and Network Analyzer

Distinctive features

SACE Emax 2 is a new series of low voltage power circuit breakers available up to 6000A and certified to ANSI C37 standards under UL 1066. With the ability to efficiently and simply control electrical installations – from the traditional to the more complex – with minimum impact, the new SACE Emax 2 circuit breakers represent the evolution of a circuit breaker into a Power Manager.

Efficiency

SACE Emax 2 power circuit breakers have been designed to manage, with maximum efficiency, all low voltage electrical installations: from industrial plants, naval applications, traditional and renewable power generation installations to buildings, shopping centres, data centres and communication networks.

Achieving maximum efficiency of an electrical installation in order to reduce consumption and waste requires intelligent management of power supplies and energy use. For this reason, the new technologies used in the SACE Emax 2 circuit breakers allow the productivity and reliability of installations to be optimized, and at the same time, power consumption to be reduced while fully respecting the environment.



1SDC200402F001_UL

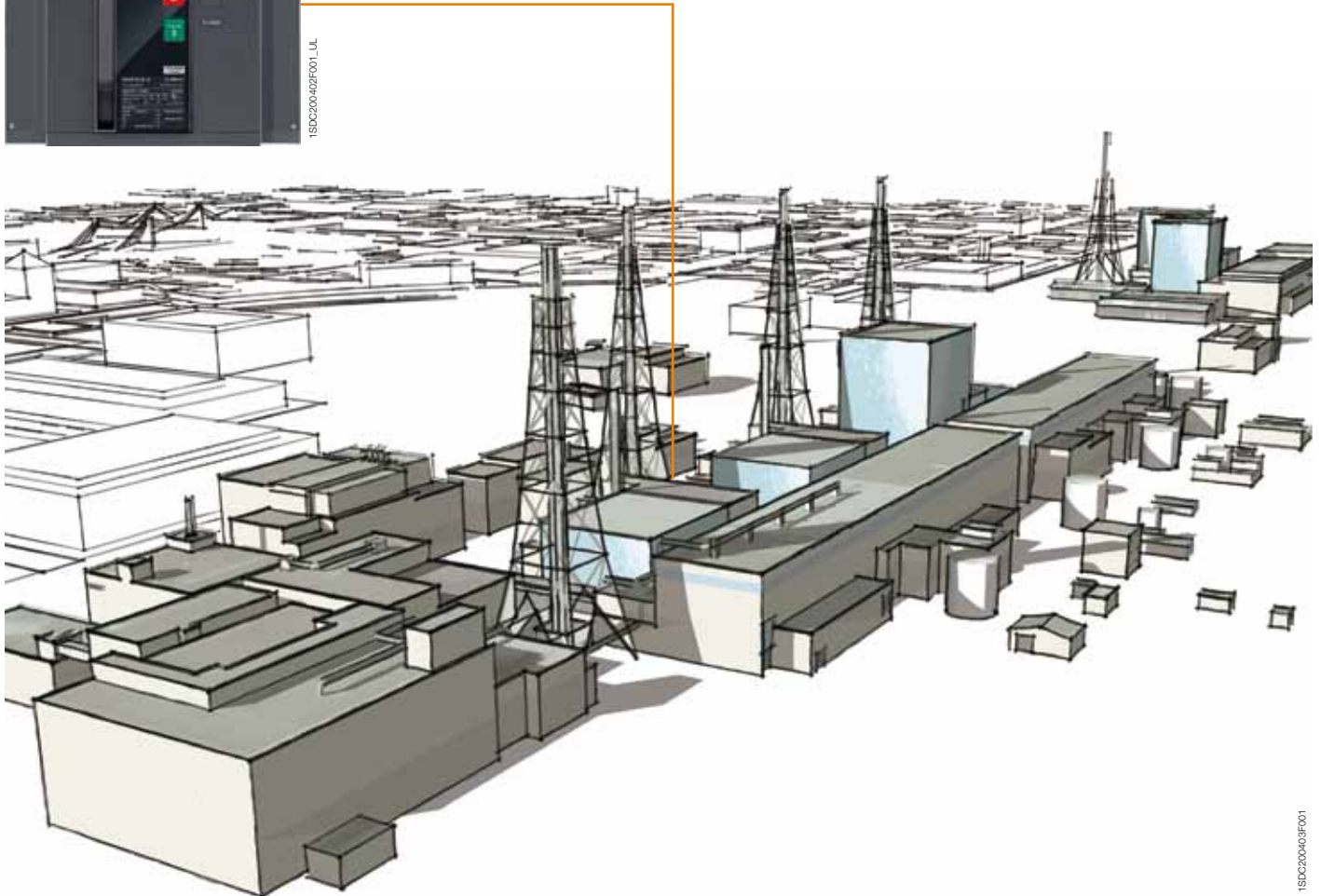

1SDC200403F001

Distinctive features

1

Control

The exclusive **Power Controller** function available on the new SACE Emax 2 circuit breakers monitors the power managed by the circuit breaker, keeping it below the limit set by the user. As a result of this more effective use, the peak of power consumed can be limited, allowing savings on electricity bills. The Power Controller, patented by ABB, disconnects non-priority utilities, such as electric car charging stations, lighting or refrigeration units, during the times when consumption limits need to be respected, and connects them again as soon as it is appropriate. When required, it automatically activates auxiliary power supplies such as generator sets. No monitoring system is required: it is sufficient to set the required load limit on Emax 2, which can control any circuit breaker located downstream, even if it is not equipped with a measurement function. In installations that are already equipped with energy management systems, the load limit can also be modified remotely.

SACE Emax 2 circuit breakers are equipped with a new generation of protection trip units that are easy to program and read. The Ekip Touch trip units measure power and energy with precision and store the most recent alarms, events and measurements, in order to prevent faults to the installation or trip effectively when necessary. The Ekip Hi-Touch does the same and also features the **Network Analyzer** function, which controls the quality of absorbed power in real time and with extreme precision and it is in agreement with *IEEE 1159 Recommended Practice for Monitoring Electric Power Quality* and *IEEE 1250; Guide for Identifying and Improving Voltage Quality in Power Systems*. In addition, the innovative Ekip Touch and Hi-Touch trip units in the G version include all the functions of generator protection switchgear, offering a safe control solution that is ready to use. No external devices, wiring or inspections are required. The Ekip G trip unit functions are in agreement with the parameters and settings detailed in *IEEE 242; IEEE Recommended Practice for Protection and Coordination of Industrial and Power Systems* and *IEEE C37.102; IEEE Guide for AC Generator Protection*.

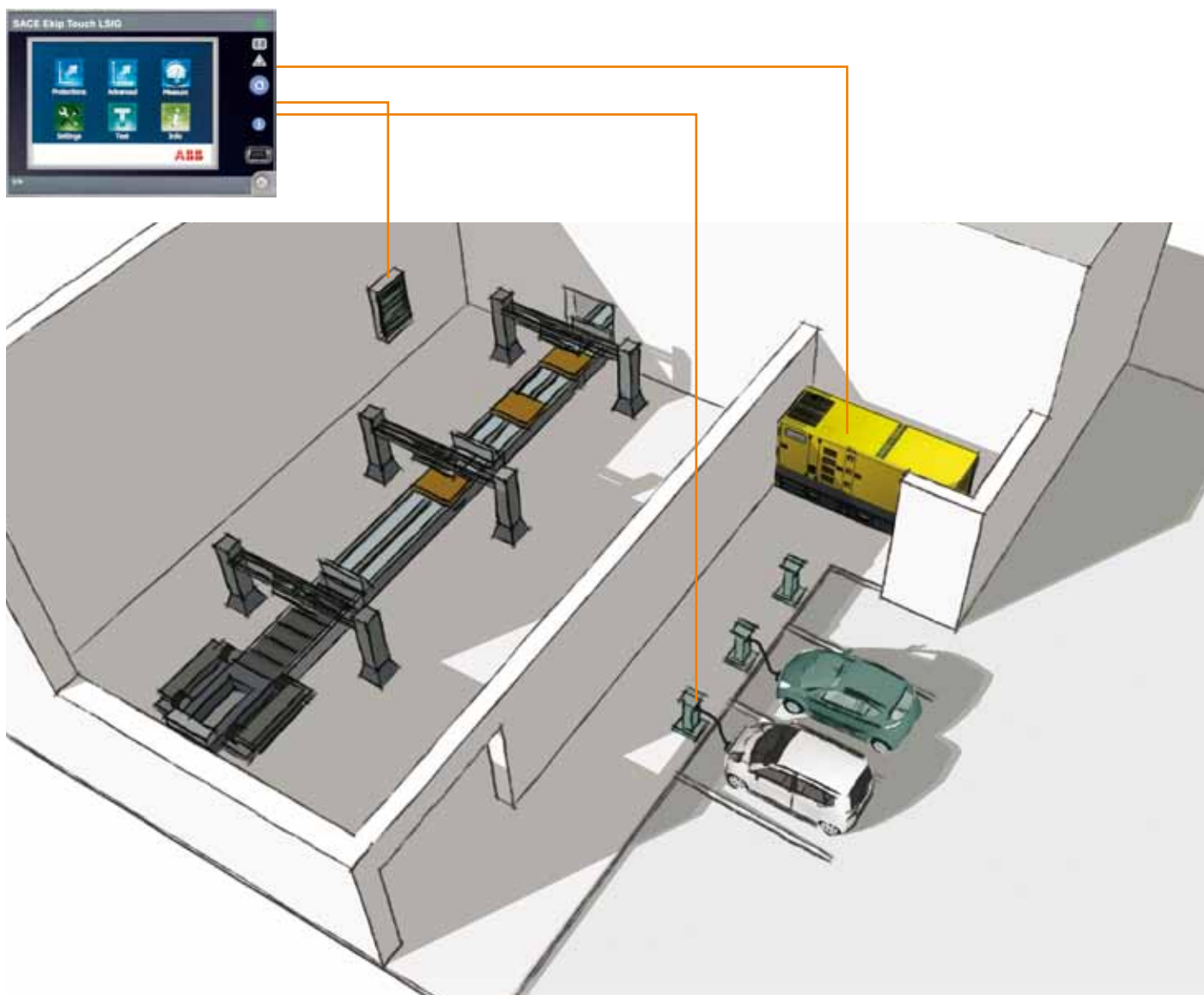

Connectivity

SACE Emax 2 series circuit breakers can be integrated perfectly into all automation and energy management systems to improve productivity and energy consumption and to carry out remote service.

All circuit breakers can be equipped with communication units available for direct use with Modbus, Profibus, and DeviceNet protocols as well as the modern Modbus TCP, Profinet and EtherNet IP protocols. The cartridge-type modules can be easily installed directly on the terminal box, even at a later date.

Furthermore, the integrated IEC61850 communication module enables connection to automation systems widely used in medium voltage power distribution to create intelligent networks (Smart Grids).

Accurate measurements of current, voltage, power and energy are all available by means of the communication modules.

The trip units themselves can be used as multimeters that display the measurements available, or the Ekip Multimeter can be connected in the front of the switchgear without the need for external instruments and bulky transformers.

All circuit breaker functions are also accessible via the Internet, in complete safety, through the Ekip Link switchgear supervision system and the Ekip Control Panel operator panel.

The power and auxiliary connections are optimized to simplify connection to the switchgear. The power terminals, which can be oriented horizontally or vertically, have been designed to easily mount to the most common busbar arrangements without modification, while the push-in connections of the auxiliaries ensure immediate and safe wiring.



1SDC200039D0201

Distinctive features

1

Performance

The SACE Emax 2 for UL 1066 range is made up of 4 sizes: E1.2, E2.2, E4.2 and E6.2 up to 6000A, which enable switchgear of compact dimensions and high ratings to be built with busbars of reduced length and cross-section.

The protection trip units, auxiliary connections and main accessories are the same throughout the range to simplify design and installation. Furthermore, the sizes from E2.2 to E6.2 have the same height and depth.

The rating levels are updated and uniform throughout the sizes to meet the demands and needs of today's installations, from 42kA to 200kA in both 508V and 635V, and to standardize switchgear projects.

High short-time withstand currents, together with the efficiency of the protection functions, guarantee complete selectivity in all situations. Accurate design and choice of materials enable optimization of the overall dimensions of the circuit breaker. In this way switchgear of compact dimensions can be built and outstanding savings at the same performance can be obtained.

In particular:

- **E1.2** offers 1200A with an interrupting rating of up to 65kA and a short-time withstand current of 50kA in an extremely compact structure. In the three and four pole version, it offers the sturdiness of SACE Emax with reduced dimensions and enables switchgear of 65kA to be built in units of 16 inches, which is indispensable in places where reduced dimensions are essential, such as naval and offshore installations.
- **E2.2** enables ratings of up to 2000A to be achieved in switchgear with a width of 16 inches when the three pole version is used. In addition, it provides an interrupting rating of up to 100kA and withstand current of up to 85kA.
- **E4.2** is the new standard for circuit breakers up to 3200A. It is designed for interrupting ratings up to 200kA at 508V and short-time withstand currents of up to 100kA without the need for particular precautions.
- **E6.2** is the top of the range, with an interrupting rating of 200kA, a withstand rating of up to 100kA and a structure that allows 6000A to be reached, even in complex installation conditions.

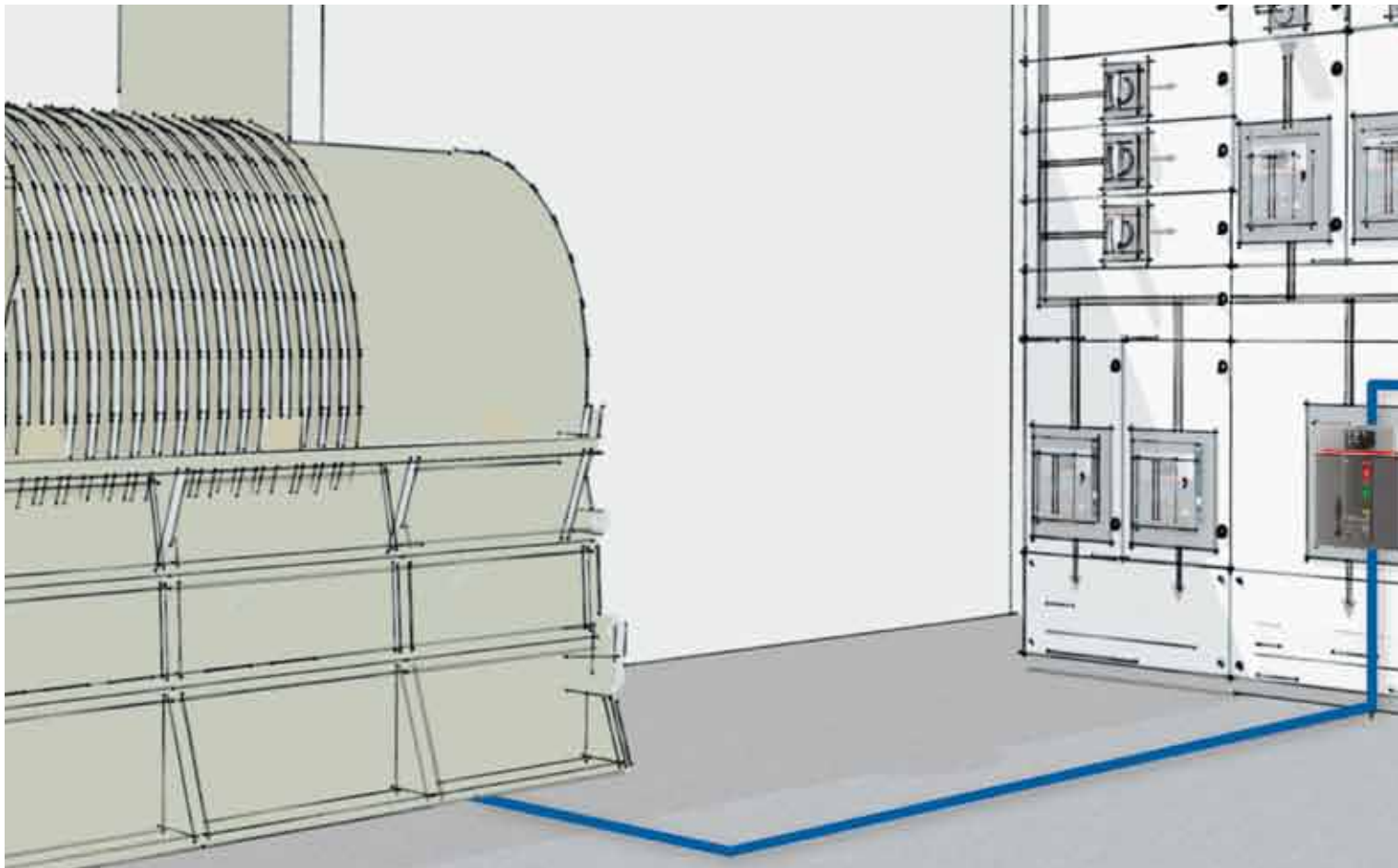

Ease of use and safety

The entire range is available in fixed and drawout versions, with double insulation between the front of the switchgear and the live parts to ensure operation in complete safety. The circuit breakers can be powered either from above or below.

All essential information is available in the central area of the front cover and enables immediate identification of the status of the circuit breaker: open, closed, ready to close, charged and discharged springs.

Maintenance is simple and safe. Thanks to the new front cover, the main accessories can be frontally accessed without exposing the operating mechanism or other components.

The drawout circuit breaker is inserted and removed via dedicated guide rails that can be fully extended outward and simplify movement. The correct movement from racked-in, test isolated, to racked-out position is guaranteed by a lock in each position. As a further guarantee of safety, the shutters of the cradle can be locked from the front when the circuit breaker is removed. The shutters of the upper terminals are independent of those of the lower terminals to facilitate checking and maintenance operations.

The Ekip Touch and Hi-Touch protection trip units are equipped with a large, color touch-screen display that enables safe and intuitive operation. Furthermore the Ekip units can be programmed and consulted from a tablet, smart phone or portable PC via the Ekip Connect application.

The trip units are easily interchangeable from the front of the circuit breaker, and all communication units can be installed directly on the terminal box with a few simple operations.

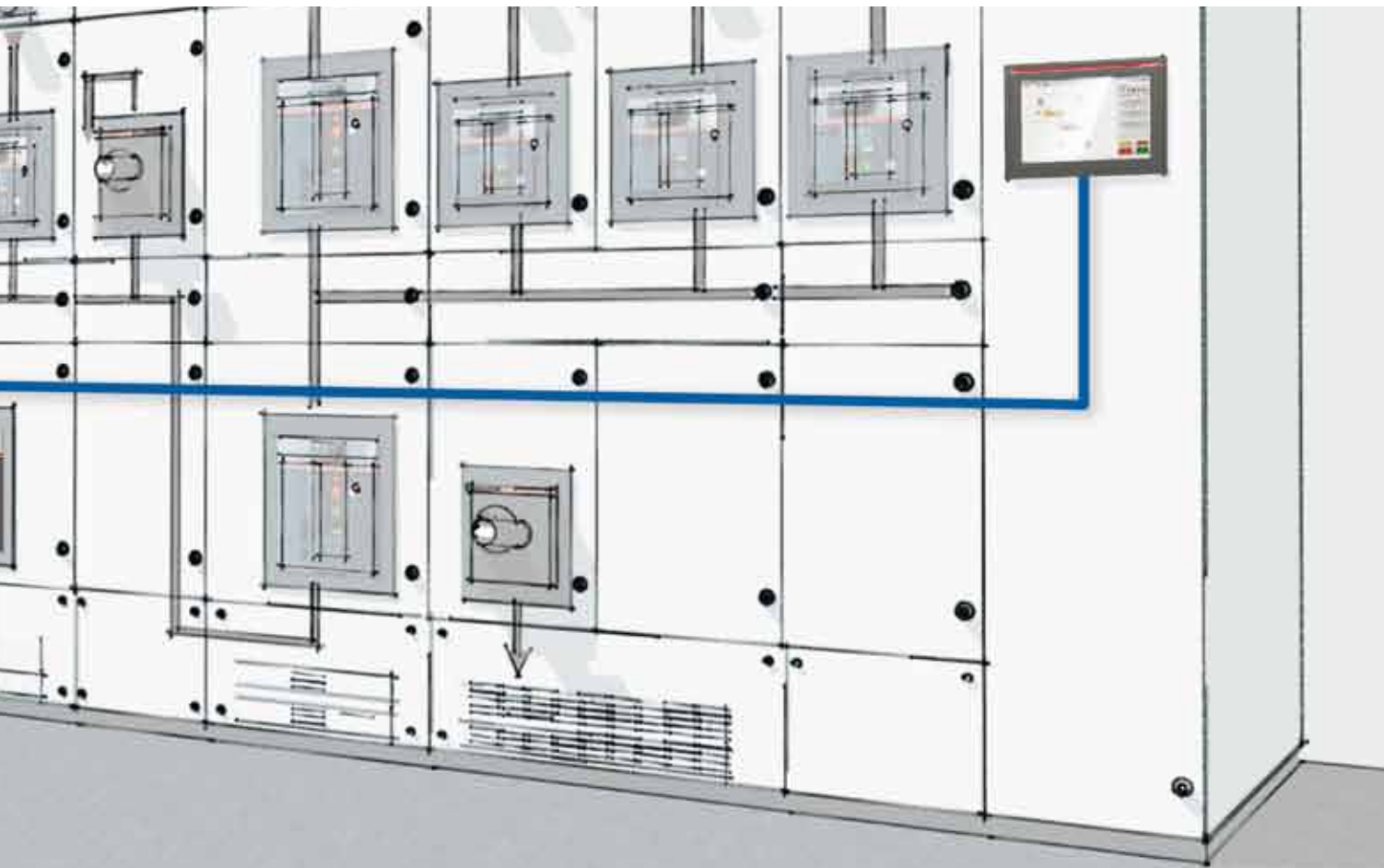

1SDC200039D0201

Distinctive features

1



Key

- 1 Trademark and size of circuit breaker
- 2 SACE Ekip protection trip unit
- 3 Pushbutton for manual opening
- 4 Pushbutton for manual closing
- 5 Lever to manually charge closing springs
- 6 Electrical rating plate
- 8 Signal for springs charged or discharged
- 9 Mechanical signalling of overcurrent release tripped
- 10 Size and serial number

Product conformity

The SACE Emax 2 circuit breakers and their accessories conform with ANSI C37.13, C37.16, C37.17 and C37.50 standards and are UL 1066 certified. The UL 1066 certification allows Emax 2 to be used in UL 1558 switchgear, UL 891 switchboards and CSA C22.2 no. 31 switchgear assemblies.

Approvals and certifications



The SACE Emax 2 family also includes a range that conforms to the international IEC 60947, EN 60947 (harmonized in 30 CENELEC countries), CEI EN 60947 and IEC 61000 Standards and complies with the following EC directives:

- “Low Voltage Directives” (LVD) no. 2006/95/EC
- “Electromagnetic Compatibility Directive” (EMC) no. 2004/108/EC.

The IEC range is also certified by the Russian certification body GOST (Russia Certificate of Conformity) and has achieved China CCC Certification (China Compulsory Certification).

Certification of conformity with the above-mentioned product Standards is carried out in compliance with the European EN 45011 Standard by the Italian certification body ACAE (Association for the Certification of Electrical Equipment), which is recognized by the European organization LOVAG (Low Voltage Agreement Group), and by the Swedish Intertek SEMKO certification organization Intertek Semko which is recognized by the international organization IECCE.

The main versions of the devices are approved by the following shipping registers

	<p>Registro Italiano Navale (RINA): Italian</p>		<p>Germanischer Lloyd (GL): Deutsch</p>		<p>Russian Maritime Register of Shipping (RMRS): Russian</p>
	<p>Lloyd's Register of Shipping (LR): English</p>		<p>Bureau Veritas (BV): French</p>		<p>Nippon Kaiji Kyokai (NKK): Japan</p>
	<p>American Bureau of Shipping (ABS): American</p>		<p>Det Norske Veritas (DNV): Norway</p>		

For the types of certified circuit breakers, certified ratings and corresponding validity, please contact ABB.

Product conformity

1

Quality and Sustainability: company efficiency and integrated management systems. Quality, Sustainability and Customer Satisfaction have always been ABB SACE's major commitment.

The involvement of all company departments and organization of processes have led ABB to develop, implement and certify management systems in compliance with international standards:

- ISO 9001 for quality management
- IRIS for the quality of supplies in the railway sector (International Railway Industry Standards)
- ISO 14001 for environmental management
- OHSAS 18001 for the management of the health and safety of employees in the workplace
- SA 8000 for the management of social responsibility.



The ABB SACE testing laboratory, accredited by ACCREDIA in compliance with the ISO/IEC 17025 Standard, provides both ABB and external customers with a qualified service of performing certification tests on devices and electric equipment of low and medium voltage in accordance with the relevant product Standards.

Thanks to the implementation of systems and their integration (Integrated Management System), ABB SACE, with a view to continuous improvement, has implemented processes with a focus on:

- quality, preventing defects and faults along the entire supply chain
- environment, reviewing production processes in terms of ecology and waste reduction, rationalizing the consumption of raw materials and energy, preventing pollution, containing noise emissions and reducing the quantity of rejects in the production processes
- health and safety of employees, offering a healthy and safe workplace in all of the various stages of work with a “zero accident objective”
- social responsibility, guaranteeing the respect of human rights and the absence of any discrimination throughout the supply chain, and offering a favourable and transparent working atmosphere.

A further commitment aimed at safeguarding the environment has been achieved by assessing products’ life cycles (LCA, Life Cycle Assessment). This includes the assessment and improvement of the environmental performance of products from the engineering stage throughout their entire life cycle. The materials, processes and packaging used are chosen with a view to optimising the actual environmental impact of each product, including its energy efficiency and recyclability.



ABB SACE Global Service

1

ABB's technical assistance service offers solutions aimed at supporting customers in all stages of the lifespan of the circuit breaker in service and covering the entire chain of value; ABB is present from the moment of selection to the end of the life of the product, thereby guaranteeing the investments of its customers.

ABB supplies annual updates regarding the evolution of the circuit breaker ranges (Life Cycle Management) and for each product it provides details of associated services and the level of support available, so that customers can choose the products and spare parts best suited to their needs.

ABB's organisation offers services that include installation and commissioning, technical training on the use and maintenance of products, the supply of original spare parts, corrective and preventive maintenance, equipment diagnostics, modernisation of systems with upgrades and retrofitting kits, consultancy services and personalised maintenance and service contracts. All this is supported by one of the most extensive global sales and service networks.

Retrofitting kit

Through continuous research targeted at the needs of the customer, ABB SACE Service has developed innovative retrofitting kits in order to simplify and speed up installation of a new circuit breaker, updating the customer's investment with the latest technology available and with very limited down times.

The retrofitting kit between Emax 2 and Emax is a refill solution: it is therefore possible to replace the drawout version of Emax with an equivalent Emax 2 model without changing the switchboard busbars, by simply removing the cradle of Emax replacing it with a cradle of Emax 2 which has been suitably modified with dedicated terminals.

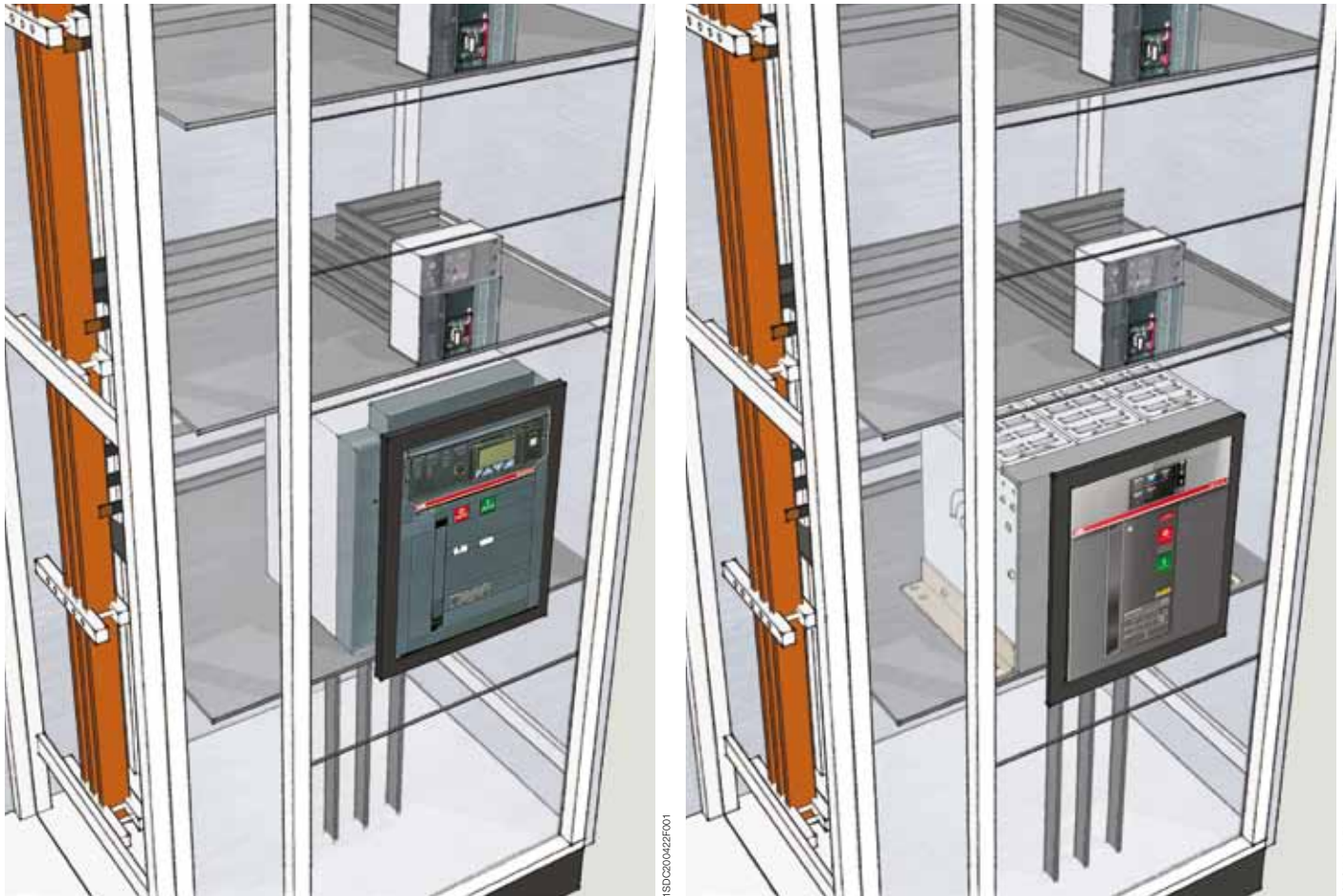

The Ranges

<u>SACE Emax 2 power circuit breakers UL 1066</u>	<u>2/2</u>
<u>SACE Emax 2 switch disconnectors UL 1066</u>	<u>2/4</u>
<u>SACE Emax 2 power circuit breakers IEC 60947</u>	<u>2/6</u>
<u>SACE Emax 2 switch disconnectors IEC 60947</u>	<u>2/8</u>
<u>SACE Emax 2 power circuit breakers and switch disconnectors for applications up to 1150V AC IEC 60947</u>	<u>2/10</u>
<u>SACE Emax 2 other versions</u>	<u>2/12</u>

SACE Emax 2 power circuit breakers UL 1066

2

Common data

Rated maximum voltage	[V]	635
Rated voltage	[V]	600
Test voltage (1min. 50/60 Hz)	[kV]	2.2
Frequency	[Hz]	50 - 60
Number of poles		3 - 4
Version		Fixed (F) - Drawout (W)



SACE Emax 2 for UL1066

SACE Emax 2 for UL1066			E1.2		
Performance levels			B-A	N-A	S-A
Current		[A]	800	800	250
		[A]	1200	1200	400
		[A]			800
		[A]			1200
		[A]			
		[A]			
Neutral pole current-carrying capacity for 4 pole CBs		[%Iu]	100	100	100
Interrupting rating at rated maximum voltage	254 V	[kA]	42	50	65
	508 V	[kA]	42	50	65
	635 V	[kA]	42	42	42
Rated short time current		[kA]	42	50	50
Trip times	Break time with fault current < rated short time current	[ms]	40	40	40
	Break time with fault current > rated short time current	[ms]	25	25	25
Overall dimensions	H - Fixed	[in/mm]	11.65 / 296		
	D - Fixed	[in/mm]	7.20 / 183		
	W - Fixed 3p	[in/mm]	8.27 / 210		
	W - Fixed 4p/4p full size	[in/mm]	11.02 / 280		
	H - Draw out	[in/mm]	14.33 / 363.5		
	D - Draw out	[in/mm]	11.06 / 281		
	W - Draw out 3p	[in/mm]	10.94 / 278		
	W - Draw out 4p/4p full size	[in/mm]	13.70 / 348		
Weights	Fixed 3p / 4p / 4p full size	[lbs/Kg]	30.9/35.3 lbs - 14/16 kg		
	Draw out 3p / 4p / 4p full size	[lbs/Kg]	90.4/102.5 lbs - 41/46.5 kg		

SACE Emax 2 for UL1066

SACE Emax 2 for UL1066			E1.2		
Mechanical life with regular ordinary maintenance prescribed by the manufacturer		[A]	< 800	800	1200
		[No. cycles x 1000]	20	20	20
	Frequency	[Cycles/Hour]	60	60	60
Electrical life with regular ordinary maintenance prescribed by the manufacturer	508 V	[No. cycles x 1000]	8	8	7
	635 V	[No. cycles x 1000]	8	8	6.5
	Frequency	[Cycles/Hour]	30	30	30

1) Version not yet available. Contact ABB.



E2.2					E4.2					E6.2				
B-A	N-A	S-A	H-A	V-A	S-A	H-A	V-A	L-A	X-A ¹⁾	H-A	V-A	L-A	X-A ¹⁾	
1600	1600	800	800	250	2500	2500	800	800	1600	4000	4000	4000	4000	
	2000	1200	1200	400	3200	3200	1600	1600	2000	5000	5000	5000	5000	
		1600	1600	800			2000	2000	2500	6000 ¹⁾	6000 ¹⁾	6000 ¹⁾	6000 ¹⁾	
		2000	2000	1200			2500	2500	3200					
				1600			3200	3200						
				2000										
100	100	100	100	100	100	100	100	100	100	50-100	50-100	50-100	50-100	
42	50	65	85	100	65	85	100	125	200	85	100	150	200	
42	50	65	85	100	65	85	100	125	200	85	100	150	200	
42	50	65	85	85	65	85	100	100	200	85	100	100	200	
42	50	65	85	85	65	85	100	100	50	85	100	100	100	
40	40	40	40	40	40	40	40	40	40	40	40	40	40	
25	25	25	25	25	25	25	25	25	25	25	25	25	25	
14.61/371					14.61/371					14.61/371				
10.63/270					10.63/270					10.63/270				
10.87/276					15.12/384					30.00/762				
14.41/366					20.08/510					34.96/888 - 39.92/1014				
16.73/425					16.73/425					16.73/425				
15.47/393					15.47/393					15.47/393				
12.48/317					16.73/425					31.61/803				
407/16.02					21.69/551					36.57/929 - 42.09/1069				
115/148 lbs - 52/67 Kg					Up to 2500A: 161/203 lbs - 73/92 kg 3200A: 201/256 lbs - 91/116 kg					314/360/406 lbs 142/163/184 kg				
up to 1600A: 128/150 lbs - 58/68 Kg 2000A: 135/239lbs - 61/108kg					Up to 2500A: 261/325 lbs - 118/147 kg 3200A: 300/377 lbs - 136/171 kg					486/554/620 lbs 220/251/281 kg				

E2.2			E4.2			E6.2		
< 1600	1600	2000	< 2500	2500	3200	4000	5000	6000
25	25	25	20	20	20	12	12	12
60	60	60	60	60	60	60	60	60
15	12	10	10	8	7	4	3	2
15	10	8	10	8	7	4	2	2
30	30	30	20	20	20	10	10	10

SACE Emax 2 switch disconnectors UL 1066

2

Common data		
Rated maximum voltage	[V]	635
Rated voltage	[V]	600
Test voltage (1min. 50/60 Hz)	[kV]	2.2
Frequency	[Hz]	50 - 60
Number of poles		3 - 4
Version		Fixed (F) - Drawout (W)



SACE Emax 2 for UL1066			E1.2	
Performance levels			B-A	N-A
Current		[A]	800	800
		[A]	1200	1200
		[A]		
		[A]		
		[A]		
Neutral pole current-carrying capacity for 4 pole CBs		[%Iu]	100	100
Rated short time current		[kA]	42	50 ¹⁾
Overall dimensions	H - Fixed	[in/mm]	11.65 / 296	
	D - Fixed	[in/mm]	7.20 / 183	
	W - Fixed 3p	[in/mm]	8.27 / 210	
	W - Fixed 4p/4p full size	[in/mm]	11.02 / 280	
	H - Draw out	[in/mm]	14.33 / 363.5	
	D - Draw out	[in/mm]	11.06 / 281	
	W - Draw out 3p	[in/mm]	10.94 / 278	
	W - Draw out 4p/4p full size	[in/mm]	13.70 / 348	

1) Rated short-time current is equal to 42kA at 635V.

SACE Emax 2 for UL1066			E1.2	
Mechanical life with regular ordinary maintenance prescribed by the manufacturer		[A]	800	1200
		[No. cycles x 1000]	20	20
	Frequency	[Cycles/Hour]	60	60
Electrical life with regular ordinary maintenance prescribed by the manufacturer	508 V	[No. cycles x 1000]	8	7
	635 V	[No. cycles x 1000]	8	6.5
	Frequency	[Cycles/Hour]	30	30

1) Version not yet available. Contact ABB.



1SDC200499F001_UL



1SDC200499F001_UL



1SDC200499F001_UL

E2.2			E4.2			E6.2		
N-A	S-A	V-A	S-A	V-A	L-A		L-A	
1600	800	800	2500	2500	800		4000	
2000	1600	1600	3200	3200	1600		5000	
	2000	2000			2000		6000 ¹⁾	
					2500			
					3200			
100	100	100	100	100	100	100	50-100	50-100
50	65	85	65	85	100	50	100	100
14.61/371			14.61/371			14.61/371		
10.63/270			10.63/270			10.63/270		
10.87/276			15.12/384			30.00/762		
14.41/366			20.08/510			34.96/888 - 39.92/1014		
16.73/425			16.73/425			16.73/425		
15.47/393			15.47/393			15.47/393		
12.48/317			16.73/425			31.61/803		
407/16.02			21.69/551			36.57/929 - 42.09/1069		

E2.2			E4.2			E6.2		
< 1600	1600	2000	< 2500	2500	3200	4000	5000	6000
25	25	25	20	20	20	12	12	12
60	60	60	60	60	60	60	60	60
15	12	10	10	8	7	4	3	2
15	10	8	10	8	7	4	2	2
30	30	30	20	20	20	10	10	10

SACE Emax 2 power circuit breakers IEC 60947

2

Common data

Rated service voltage Ue	[V]	690
Rated insulation voltage Ui	[V]	1000
Rated impulse withstand voltage Uimp	[kV]	12
Frequency	[Hz]	50 - 60
Number of poles		3- 4
Version		Fixed (F) - Drawout (W)
Isolation behaviour		IEC 60947-2



SACE Emax 2 for IEC 60947

			E1.2			
Performance levels			B	C	N	L
Rated uninterrupted current Iu @ 40°C		[A]	630	630	250	630
		[A]	800	800	630	800
		[A]	1000	1000	800	1000
		[A]	1250	1250	1000	1250
		[A]	1600	1600	1250	
		[A]			1600	
		[A]				
Neutral pole current-carrying capacity for 4-pole CBs		[%Iu]	100	100	100	100
Rated ultimate short-circuit breaking capacity Icu	400-415 V	[kA]	42	50	66	150
	440 V	[kA]	42	50	66	130
	500-525 V	[kA]	42	42	50	100
	690 V	[kA]	42	42	50	45
Rated service short-circuit breaking capacity Ics		[%Icu]	100	100	100 ¹⁾	100
Rated short-time withstand current Icw	(1s)	[kA]	42	42	50	15
	(3s)	[kA]	24	24	36	-
Rated short-circuit making capacity (peak value) Icm	400-415 V	[kA]	88	105	145	330
	440 V	[kA]	88	105	145	286
	500-525 V	[kA]	88	88	105	220
	690 V	[kA]	88	88	105	132
Utilization category (according to IEC 60947-2)			B	B	B	A
Breaking time	I<Icw	[ms]	40	40	40	40
	I>Icw	[ms]	25	25	25	10
Dimensions	H - Fixed/Withdrawable	[mm]	296/363.5	296/363.5	296/363.5	296/363.5
	D - Fixed/Withdrawable	[mm]	183/271	183/271	183/271	183/271
	W - Fixed 3p/4p/4p full size	[mm]	210/280			
	W - Withdrawable 3p/4p/4p full size	[mm]	278/348			
Weights (CB with trip unit and current sensor)	Fixed 3p/4p	kg	14/16			
	Withdrawable 3p/4p/4p full size including fixed part	kg	38/43			

1) Ics: 50kA for 400V...440V voltage; 2) Ics: 125kA for 400V...440V voltage; 3) E4.2H 3200A: 66kA Icw (3s)

SACE Emax 2 for IEC 60947

			E1.2			
Mechanical life with regular ordinary maintenance prescribed by the manufacturer		[Iu]	≤ 1000	1250	1600	1250 L
		[No. cycles x 1000]	20	20	20	20
	Frequency	[Oper./Hour]	60	60	60	60
Electrical life with regular ordinary maintenance prescribed by the manufacturer	440 V	[No. cycles x 1000]	8	8	8	3
	690 V	[No. cycles x 1000]	8	6.5	6.5	1
	Frequency	[Oper./Hour]	30	30	30	30



E2.2				E4.2				E6.2			
B	N	S	H	N	S	H	V	H	V	X	
1600	800	250	800	3200	3200	3200	2000	4000	4000	4000	
2000	1000	800	1000	4000	4000	4000	2500	5000	5000	5000	
	1250	1000	1250				3200	6300	6300	6300	
	1600	1250	1600				4000				
	2000	1600	2000								
	2500	2000	2500								
		2500									
100	100	100	100	100	100	100	100	50-100	50-100	50-100	
42	66	85	100	66	85	100	150	100	150	200	
42	66	85	100	66	85	100	150	100	150	200	
42	66	66	85	66	66	85	100	100	130	130	
42	66	66	85	66	66	85	100	100	100	120	
100	100	100	100	100	100	100	100 ²⁾	100	100	100	
42	66	66	85	66	66	85	100	100	100	120	
42	50	50	66	50	66	75 ³⁾	75	100	100	100	
88	145	187	220	145	187	220	330	220	330	440	
88	145	187	220	145	187	220	330	220	330	440	
88	145	145	187	145	145	187	220	220	286	286	
88	145	145	187	145	145	187	220	220	220	264	
B	B	B	B	B	B	B	B	B	B	B	
40	40	40	40	40	40	40	40	40	40	40	
25	25	25	25	25	25	25	25	25	25	25	
371/425	371/425	371/425	371/425	371/425	371/425	371/425	371/425	371/425	371/425	371/425	
270/383	270/383	270/383	270/383	270/383	270/383	270/383	270/383	270/383	270/383	270/383	
276/366				384/510				762/888/1014			
317/407				425/551				803/929/1069			
41/53				56/70				109/125/140			
54/99				110/136				207/234/260			

E2.2				E4.2				E6.2			
< 1600	1600	2000	2500	< 2500	2500	3200	4000	4000	5000	6300	
25	25	25	20	20	20	20	15	12	12	12	
60	60	60	60	60	60	60	60	60	60	60	
15	12	10	8	10	8	7	5	4	3	2	
15	10	8	7	10	8	7	4	4	2	2	
30	30	30	30	20	20	20	20	10	10	10	

SACE Emax 2 switch disconnectors IEC 60947

Switch disconnectors, identified with the abbreviation “/MS”, are devices that satisfy the isolating specifications provided by the IEC 60947-3 Standard. The switch disconnectors are derived from the corresponding automatic circuit breakers, and they have the same dimensions and accessory options. This version differs from the automatic circuit breakers only because of the absence of protection trip units.

2

Common data

Rated service voltage Ue	[V]	690
Rated insulation voltage Ui	[V]	1000
Rated impulse withstand voltage Uimp	[kV]	12
Frequency	[Hz]	50 - 60
Number of poles		3- 4
Version		Fixed (F) - Drawout (W)
Isolation behaviour		IEC 60947-3



SACE Emax 2 for IEC 60947

SACE Emax 2 for IEC 60947			E1.2	
Performance levels			B/MS	N/MS
Rated uninterrupted current Iu @ 40°C		[A]	630	250
		[A]	800	630
		[A]	1000	800
		[A]	1250	1000
		[A]	1600	1250
		[A]		1600
Neutral pole current-carrying capacity for 4-pole CBs		[%Iu]	100	100
Rated short-time withstand current Icw	(1s)	[kA]	42	50
	(3s)	[kA]	24	36
Rated short-circuit making capacity (peak value) Icm	400-415 V	[kA]	88	105
	440 V	[kA]	88	105
	500-525 V	[kA]	88	105
	690 V	[kA]	88	105
Utilization category (according to IEC 60947-3)			AC-23A	AC-23A
Dimensions	H - Fixed / Withdrawable	[mm]	296 / 363.5	296 / 363.5
	D - Fixed / Withdrawable	[mm]	183 / 271	183 / 271
	W - Fixed 3p/4p/4p full size	[mm]	210 / 280	
	W - Withdrawable 3p/4p/4p full size	[mm]	278 / 348	

SACE Emax 2 for IEC 60947

SACE Emax 2 for IEC 60947			E1.2		
Mechanical life with regular ordinary maintenance prescribed by the manufacturer		[Iu]	< 1000	1000	1600
		[No. cycles x 1000]	20	20	20
	Frequency	[Oper./Hour]	60	60	60
Electrical life with regular ordinary maintenance prescribed by the manufacturer	440 V	[No. cycles x 1000]	8	8	8
	690 V	[No. cycles x 1000]	8	6.5	6.5
	Frequency	[Oper./Hour]	30	30	30

The device, when in the open position, guarantees an isolating distance between the main contacts of the circuit breaker that is sufficient to ensure that the installation downstream is not live.

Furthermore the switch disconnectors, if used with an external protection relay with maximum delay of 500ms, enable a breaking capacity at a maximum rated operating voltage (Ue) equal to the value of rated short-time withstand current (Icw) for one second.



E2.2			E4.2			E6.2		
B/MS	N/MS	H/MS	N/MS	H/MS	V/MS	H/MS	X/MS	
1600	800	800	3200	3200	2000	4000	4000	
2000	1000	1000	4000	4000	2500	5000	5000	
	1250	1250			3200	6300	6300	
	1600	1600			4000			
	2000	2000						
	2500	2500						
100	100	100	100	100	100	50-100	50-100	
42	66	85	66	85	100	100	120	
42	50	66	36	66	75	100	100	
88	145	187	145	187	220	220	264	
88	145	187	145	187	220	220	264	
88	145	187	145	187	220	220	264	
88	145	187	145	187	220	220	264	
AC-23A	AC-23A	AC-23A	AC-23A	AC-23A	AC-23A	AC-23A	AC-23A	
371 / 425	371 / 425	371 / 425	371 / 425	371 / 425	371 / 425	371 / 425	371 / 425	
270 / 383	270 / 383	270 / 383	270 / 383	270 / 383	270 / 383	270 / 383	270 / 383	
276 / 366			384 / 510			762 / 888 / 1014		
317 / 407			425 / 551			803 / 929 / 1069		

E2.2				E4.2				E6.2			
< 1600	1600	2000	2500	< 2500	2500	3200	4000	4000	5000	6300	
25	25	25	20	20	20	20	15	12	12	12	
60	60	60	60	60	60	60	60	60	60	60	
15	12	10	8	10	8	7	5	4	3	2	
15	10	8	7	10	8	7	4	4	2	2	
30	30	30	30	20	20	20	20	10	10	10	

SACE Emax 2 power circuit breakers and switch disconnectors for applications up to 1150V AC

ABB SACE offers a solution designed for electrical applications with voltages up to 1150V in alternating current. The 1150V AC range, which maintains the same dimensions and accessories as the standard 690V AC range, is identified by the letters “/E”. The switch disconnectors are not equipped with Ekip protection trip units.

By means of external protection relay with 500 ms maximum timing, the Icu breaking capacity is equal to the value of Icw (1s).

2

Common data

Rated service voltage Ue	[V]	1150
Rated insulation voltage Ui	[V]	1250
Rated impulse withstand voltage Uimp	[kV]	12
Frequency	[Hz]	50 - 60
Number of poles		3- 4
Version		Fixed (F) - Drawout (W)
Isolation behaviour		IEC 60947-2 and -3



SACE Emax 2 power circuit breaker for applications up to 1150V AC

			E1.2
Performance levels			N/E
Rated uninterrupted current Iu @ 40°C	[A]		630, 800, 1000, 1250, 1600
Neutral pole current-carrying capacity for 4-pole CBs	[%Iu]		100
Rated ultimate short-circuit breaking capacity Icu	1000 V	[kA]	30
	1150 V	[kA]	25
Rated service short-circuit breaking capacity Ics	[%Icu]		100
Rated short-time withstand current Icw (1s)		[kA]	25
	(3s)	[kA]	25
Rated short-circuit making capacity (peak value) Icm	1000 V	[kA]	63
	1150 V Z	[kA]	53
Utilization category (according to IEC 60947-2)			B

SACE Emax 2 switch disconnector for applications up to 1150V AC

			E1.2
Performance levels			N/E MS
Rated uninterrupted current Iu @ 40°C	[A]		630, 800, 1000, 1250, 1600
Neutral pole current-carrying capacity for 4-pole CBs	[%Iu]		100
Rated short-time withstand current Icw	(1s)	[kA]	25
	(3s)	[kA]	25
Rated short-circuit making capacity (peak value) Icm	1000 V	[kA]	53
	1150 V	[kA]	53

SACE Emax 2 power circuit breaker and switch disconnector for applications up to 1150V AC

			E1.2		
Mechanical life with regular ordinary maintenance prescribed by the manufacturer	[Iu]		< 1000	1000	1600
	[No. cycles x 1000]		20	20	20
	Frequency [Oper./Hour]		60	60	60
Electrical life with regular ordinary maintenance prescribed by the manufacturer	1150 V	[No. cycles x 1000]	1	1	1
	Frequency	[Oper./Hour]	30	30	30



1SDC200425F001_UL



1SDC200426F001_UL



1SDC200427F001_UL

E2.2			E4.2			E6.2		
H/E			H/E			X/E		
800, 1000, 1250, 1600, 2000, 2500			3200, 4000			4000, 5000, 6300		
100			100			50 - 100		
30			50			65		
30			30			65		
100			100			100		
30			50			65		
30			30			65		
63			105			143		
53			105			143		
B			B			B		

E2.2			E4.2			E6.2		
H/E MS			H/E MS			X/E MS		
800, 1000, 1250, 1600, 2000, 2500			3200, 4000			4000, 5000, 6300		
100			100			50 - 100		
30			50			65		
30			30			65		
53			105			143		
53			105			143		

E2.2			E4.2			E6.2		
< 2000	2000	2500	< 3200	3200	4000	4000	5000	6300
25	25	20	20	20	15	12	12	12
60	60	60	60	60	60	60	60	60
2	2	2	1	1	1	1	1	1
30	30	30	20	20	20	10	10	10

SACE Emax 2 other versions

2

Switch disconnectors for applications up to 1000V DC IEC 60947

ABB SACE extends its solutions to applications in direct current with a range of switch disconnectors for applications up to 1000V, which comply with the international IEC60947-3 standard.

For all applications in which integrated protection is requested in addition to isolation, ABB SACE offers SACE Emax power circuit breakers with PR122/DC and PR123/DC. For further information, please refer to the technical catalogue "SACE Emax DC. Low voltage air circuit breakers for direct current applications".

Common data

Rated service voltage Ue	[V]	750 (3p) / 1000 (4p)
Rated insulation voltage Ui	[V]	1000
Rated impulse withstand voltage Uimp	[kV]	12
Number of poles		3- 4
Version		Fixed (F) - Drawout (W)
Isolation behaviour		IEC 60947-3



SACE Emax 2 DC for IEC 60947-3

				E1.2		
Performance levels				N/DC MS		
Rated uninterrupted current Iu @ 40°C		[A]		800, 1250		
Poles				3	4	4
Rated service voltage Ue				750	750	1000
Rated insulation voltage Ui				1000	1000	1000
Rated short-time withstand current Icw	(1s)	[kA]		20	25	20
Rated short-circuit making capacity (peak value) Icm	750 V	[kA]		20	25	20
	1000 V	[kA]				20
Utilization category (according to IEC 60947-3)						

SACE Emax 2 DC for IEC 60947-3

				E1.2	
Mechanical life with regular ordinary maintenance prescribed by the manufacturer		[lu]		< 1000	1250
		[No. cycles x 1000]		20	20
	Frequency	[Oper./Hour]		60	60
Electrical life with regular ordinary maintenance prescribed by the manufacturer	1000 V	[No. cycles x 1000]		1	1
	Frequency	[Oper./Hour]			

Note: by means of external protection relay with 500 ms maximum timing, the breaking capacity Icu at the maximum rated use voltage is equal to the value of Icw (1s).

Other versions

Corrosive substances, vibrations, shocks or very low temperatures can be present in particular applications. In this regard, SACE Emax 2 circuit breakers offer specific solutions developed precisely for:

- **Aggressive environments**, such as industrial processes for paper production, oil refining or water treatment, which are subject to high levels of sulphur dioxide (SO₂) and hydrogen sulphide (H₂S) contamination.
- **Antiseismic installations**, for areas with seismic risk where industrial and civil activities take place and where the continuity of critical processes must be guaranteed, even in the case of particular natural events.

For further detail, please contact ABB.



1SDC200439F001_LUL



1SDC200439F001_LUL



1SDC200439F001_LUL

E2.2 S/DC MS			E4.2 H/DC MS			E6.2 X/DC MS		
1250, 1600, 2000, 2500			1250, 1600, 2000, 2500, 3200, 4000			4000, 5000, 6300		
3	4	4	3	4	4	3	4	4
750	750	1000	750	750	1000	750	750	1000
1000	1000	1000	1000	1000	1000	1000	1000	1000
25	40	25	40	50	40	65	65	65
25	40	25	40	50	40	65	65	65
		25			40			65

E2.2			E4.2			E6.2		
< 2000	2000	2500	< 3200	3200	4000	4000	5000	6300
25	25	20	20	20	15	12	12	12
60	60	60	60	60	60	60	60	60
2	2	2	1	1	1	1	1	1

Protection trip units

Introduction 3/2

Architecture 3/4

Protection trip units for power distribution

Ekip Dip	3/6
Ekip Touch	3/10
Ekip Hi-Touch	3/20

Protection trip units for generators

Ekip G Touch	3/24
Ekip G Hi-Touch	3/29

Protection trip units for power control

Ekip Power Controller	3/32
-----------------------	------

Technical characteristics for protection trip units

Protection functions	3/38
Measurement functions	3/46

Protection trip units

Introduction

3

The SACE Emax 2 Ekip protection trip units are the new benchmark for the protection, measurement and control of low voltage electrical systems. The result of ABB SACE's experience and research, they make Emax 2 not only a circuit breaker, but an actual Power Manager with all the functions necessary for optimal management of the system without the need for external devices.

The protection units are divided into two families: Ekip for distribution protection and Ekip G for generator protection. The trip unit range is available with three levels of performance, Dip, Touch and Hi-Touch, to satisfy simple to advanced applications. Exclusive functions such as the Ekip Power Controller and Network Analyzer complete the range, enabling power management and analysis of energy quality.

The complete, flexible Ekip protection trip unit offering, which can be adapted to the actual level of protection required, is shown below:

	Fields of applications	Measurement and Protection of Current	Measurement of Voltage, Power, Energy	Measurement and Protection of Voltage, Power, Energy	Network Analyzer	Power Control
Ekip Dip		with Ekip Multimeter	–	–	–	–
Ekip Touch	Distribution	•	with Ekip Measuring	with Ekip Measuring Pro	–	with Ekip Power Controller
Ekip Hi-Touch		•	•	•	•	
Ekip G Touch	Generators	•	•	•	–	with Ekip Power Controller
Ekip G Hi-Touch		•	•	•	•	



Ekip Power Controller function monitors installation loads and generators, permitting the power consumed to be limited and allowing savings on electricity bills.

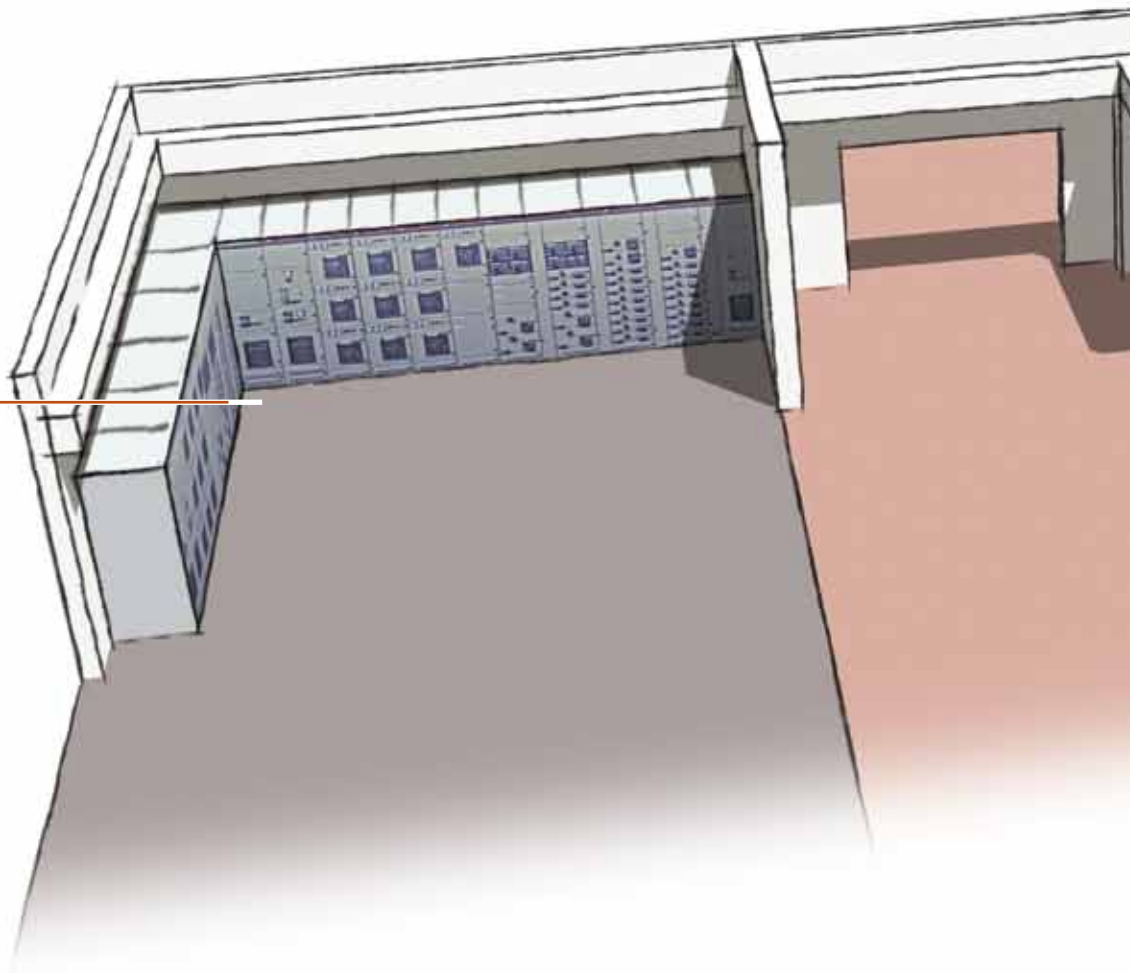

The **trip units for power distribution**, available in the LI, LSI and LSI G versions, are suited to all distribution systems. The Ekip trip units are designed to protect a vast range of applications, such as use with transformers, motors and drives. Ekip Dip, Ekip Touch or Ekip Hi-Touch can be selected, depending on the complexity of the system, the need to take voltage or energy measurements or to include control systems in switchgear.

The Ekip G range of trip units enables the **protection of generators** without the use of external devices that require dedicated relays and wiring. It was created to respect the parameters and settings detailed in IEEE 242; *IEEE Recommended Practice for Protection and Coordination of Industrial and Power Systems* and IEEE C37.102; *IEEE Guide for AC Generator Protection*, and offers a safe control solution that is ready to use. Ekip G increases efficiency from the design stage to installation, minimizing the time needed for realization and commissioning of the system, and ensuring high levels of accuracy and reliability of all protection devices required for running generators in applications such as naval, GenSet or cogeneration.

Ekip Power Controller is the new function that controls the power absorbed, thereby increasing the efficiency of the system. This ABB SACE patented function measures power and energy but also controls, loads and generators in order to optimize the power consumed, without the use of complex external automation logic.

Thanks to the **Network Analyzer** function integrated into all Hi-Touch versions, the quality of energy in terms of harmonics, micro-interruptions or voltage dips is monitored with no dedicated instrumentation required. The Network Analyzer function is in agreement with IEEE 1159; *Recommended Practice for Monitoring Electric Power Quality* and IEEE 1250; *Guide for Identifying and Improving Voltage Quality in Power Systems*. It not only acts as an Event Indicator, but provides recordings and statistics that allow effective preventive and corrective action to be implemented through accurate fault analysis, thereby improving the system's efficiency.

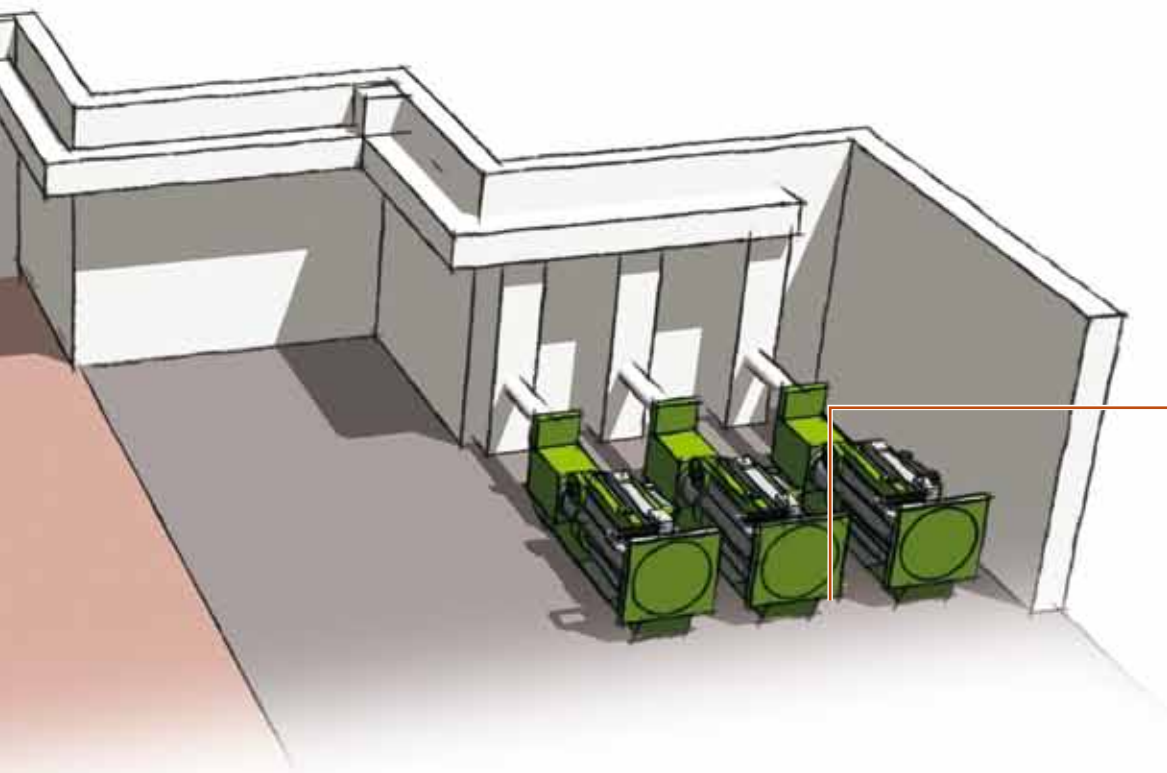

Ekip G enables the protection of generators without the use of external devices that require dedicated relays and wiring.

Protection trip units

Architecture

All SACE Emax 2 circuit breakers are equipped with protection trip units that are interchangeable from the front with just a few, simple operations by the customer. There is no need to dismantle the circuit breaker or access any internal or sensitive parts.

3

This enables personalization of the functions available, even during commissioning or when the circuit breaker has already been installed. In particular, SACE Ekip consists of:

- **Protection trip unit**, available with different interfaces and versions that range from basic to more complete; it contains a latest generation microprocessor that performs all the functions of protection and control.
- **Ekip Measuring Module**, connected internally to Emax 2, performs voltage, power and energy measurements with high accuracy without requiring any external connection or voltage transformer. The Ekip Measuring Pro version also performs all protection functions based on voltage and power without the need for external units, thereby simplifying design and construction of the system.
- **Interchangeable rating plug** enables all protection thresholds to be adjusted according to the rated current, increasing flexibility for the customer. It is useful in installations that are prepared for future development or in cases in which the power supplied may be limited temporarily.
- **Main board** is the mechanical housing of the trip unit, which includes a micro-controller for measuring currents and the self-protection functions. The separation of main board and protection trip unit ensures excellent reliability and immunity to conducted and radiated emissions. Integrated new generation Rogowski sensors, which are sensitive to the true r.m.s. value of the current, guarantee high accuracy of both measurements and protection.



1SDC20044F001

All protection trip units of the SACE Emax 2 family are self-powered by current that flows through the circuit breaker. They guarantee excellent reliability due to a system of self-controlled internal connections. The setting, testing and downloading of reports can be carried out directly from a Smartphone, Tablet or PC.

Easily installed cartridge type modules enable the units to be integrated into the most complex systems. Additional functions can be created, such as:

- **Synchrocheck**, checks the synchronization between two busbar systems before enabling circuit breaker closing;
- Communication with all **supervision systems** is available in the Modbus, Profibus and DeviceNet protocols as well as the modern Modbus TCP, Profinet and EtherNet/IP protocols;
- **Integration into Smart Grids** according to the IEC61850 standard (used to communicate with high and medium voltage substation automation systems), without the need for an external converter;
- Multi-voltage **supply module**, which enables the protection trip unit and modules present to be supplied with any auxiliary voltage available in direct or alternating current;
- Programmable logic management with **Ekip Signalling** modules that make a high number of electrical input and output contacts available;
- Logical interlocks between circuit breakers, which can be made with the **Ekip Link** proprietary communication protocol, avoiding complex wiring because of the transmission of all signals via bus.



Protection trip units for power distribution

Ekip Dip

Characteristics

Ekip Dip is the new protection trip unit of the SACE Emax 2 family for all applications in which high accuracy and reliable protection against overcurrent are required. Ekip Dip offers a complete set of standard protection functions. Dedicated LEDs allow the fault that caused tripping to be determined.

3

The unit is available in the following versions:

- Ekip Dip LI
- Ekip Dip LSI
- Ekip Dip LSIG

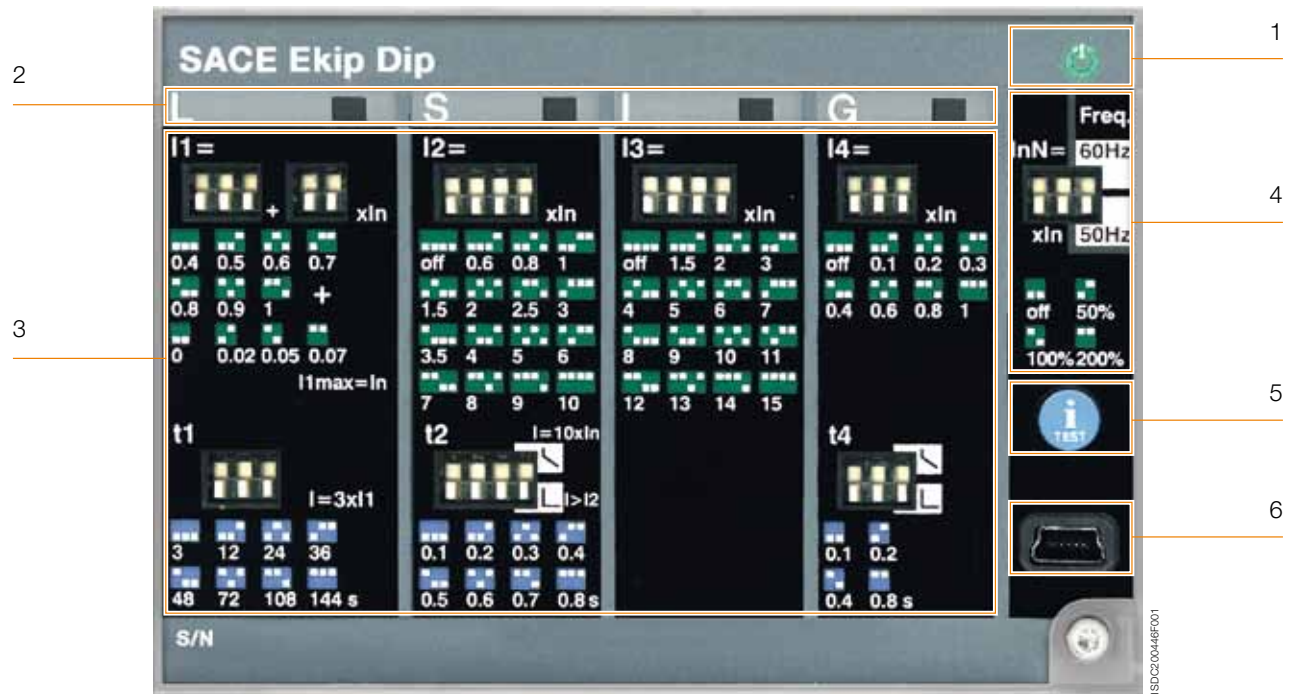

Key:

1. Power-on LED for signalling correct operation (watchdog)
2. LEDs for alarm signalling of L, S, I and G protection functions and diagnostics
3. Dip switches for setting the protection functions
4. Dip switches for setting the network frequency and neutral protection device
5. Pushbutton for test and for indicating the cause of tripping
6. Test and programming connector

Protection functions

Ekip Dip offers overcurrent protection functions and, in the event of tripping, controls the opening of the circuit breaker, preventing it from closing again unless it has been reset by the operator (lockout device – code ANSI 86).

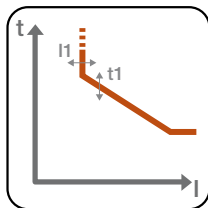

Overload (L - ANSI 49): with inverse long-time delay trip of the type $t = k/I^2$ available with 25 current thresholds and 8 curves, it provides effective protection of all systems. A pre-alarm warning is also available on reaching 90% of the threshold set.

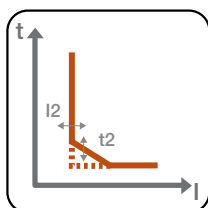

Time-delayed overcurrent (S - ANSI 51 & 50TD): with constant tripping time ($t = k$), or with constant specific let-through energy ($t = k/I^2$), it provides 15 current thresholds and 8 curves, for fine adjustment. The function can be excluded by setting the dip switch combination to “OFF”.

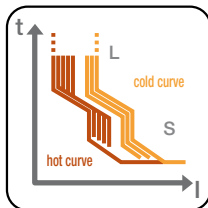

Thermal memory: for L and S protection functions, this is used to protect components, such as transformers, from overheating following an overload. The function, which can be enabled by the Ekip Connect software, adjusts the protection tripping time according to the length of time that has elapsed since the first overload, taking into account the amount of heat generated.

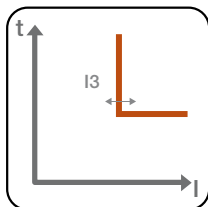

Instantaneous overcurrent (I - ANSI 50): with tripping curve without intentional delay, it offers 15 tripping thresholds and can be excluded by setting the dip switch combination to “OFF”.

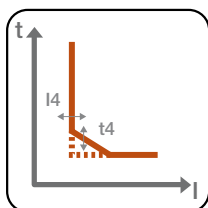

Ground fault (G - ANSI 51N & 50NTD): with tripping time independent of current ($t = k$) or constant specific let-through energy ($t = k/I^2$). The function can be excluded by setting the dip switch combination to “OFF”.

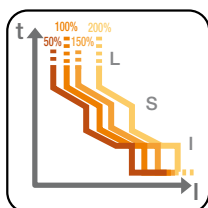

Neutral protection: available at 50%, 100% or 200% of the phase currents, or disabled, it is applied to the overcurrent protections L, S and I.

Protection trip units for power distribution

Ekip Dip

Measurements

The Ekip Dip unit measures phase and neutral current with great accuracy: 1% including the current transformers in the 0.2 ... 1.2 In range (class 1 in accordance with IEC 61557-12). Using the current sensors in the circuit breaker and without the need to install an external measuring system, it is possible to view the measurements from the display on the front of the Ekip Multimeter and Ekip Control Panel.

Ekip Dip also records the characteristics of the circuit breaker, to enable a rapid analysis during troubleshooting or maintenance:

- Maximum and average current values per phase;
- Date, time, fault current per phase and type of protection tripped over the last 30 trips;
- Date, time and type of operation of the last 200 events (for example: opening/closing of the circuit breaker, pre-alarms, editing settings);
- Number of mechanical and electric operations of the circuit breaker;
- Total operating time;
- Contact wear (endurance);
- Date and time of the last maintenance carried out, in addition to the estimate of the next maintenance required;
- Circuit-breaker identifying data: type, serial number, firmware version, name of the device as assigned by the user.

The values can be displayed on the front of the Ekip Multimeter or Ekip Control Panel or by Ekip Connect software on a Smartphone, Tablet or PC by using the communication units Ekip T&P or Ekip Bluetooth.

Watchdog

All the protection trip units of the SACE Emax 2 family ensure high reliability owing to an electronic circuit that periodically controls the continuity of the internal connections, such as trip coil, rating plug and each current sensor (Ansi 74). In the event of a malfunction, the LEDs indicate the corresponding alarm to enable the fault to be identified rapidly. Furthermore, Ekip Dip detects and indicates that the circuit breaker has been opened because one of the protection functions has been tripped (Ansi BF code). In order to preserve the correct operation of the unit, Ekip Dip is also provided with self-protection against abnormal temperature (OT) inside the protection trip unit. The user can set it to open the circuit breaker or to merely indicate an alarm.

User interface

Ekip offers a great variety of thresholds and trip times, the protections can be set by dip-switches. Up to 5 LEDs are also available (depending on the version) to indicate correct operation or alarms. The interface always enables the status of the installation to be identified clearly and quickly:

- correct operation (green LED)
- overcurrent pre-alarms or alarms
- presence of self-control functions alarms
- maintenance interval expired
- indication of tripped protection after a fault

The protection tripped indication is activated by pressing the iTest key, and operates without the need of an external power supply because a battery is installed inside the unit.

Communication

The Ekip Bluetooth wireless communication unit enables the operator to interact with the protection trip unit by computer, Smartphone or Tablet. In fact, the free Ekip Connect software for Smartphones, Tablets and PC, enables measurements and fault data to be read along with alarm status and information from the circuit breaker to be displayed. It is also possible to set parameters such as date, time and thermal memory and for records to be reset.

Test function

The test port on the front of the protection trip unit can be used to run circuit breaker tests by connecting one of the following devices:

- Ekip TT to run the trip test, the LEDs test and check absence of alarms detected by the watchdog function;
- Ekip T&P to permit not only the trip test and LEDs test but also to run the test of the individual protection functions and save the relative report;
- ITest key that is pressed to run the battery test when the circuit breaker is disconnected.

Supply

The Ekip Dip protection trip unit does not require an external supply for the protection functions or for the alarm indication functions because it is self-supplied by the current sensors installed on the circuit breaker. A three-phase 100A current suffices to activate the LED indications.

The Ekip Supply module enables an auxiliary supply to be easily connected and is able to receive both a direct current supply (24-48VDC or 110-240VDC) and an alternating current (110-240VAC) to activate additional functions such as:

- G protection at values below 100A or below 0.2 I_n;
- connecting to external devices such as Ekip Multimeter and Ekip Control Panel;
- recording the number of operations.

The Ekip Dip protection trip unit also has a battery that enables the indication of the cause of the fault to be viewed for an unlimited time after tripping. In addition to that, the battery enables date and time to be maintained and updated, thus ensuring the chronology of the events. On the other hand, when the unit is switched off, the battery test can be run by simply pressing the iTest key.

Supply	Ekip Supply	
Nominal voltage	24-48V DC	110-240V AC/DC
Voltage range	21.5 - 53V DC	105-265V AC/DC
Rated power (including modules)	10W max.	10W max.
Inrush current	~10 A for 5 ms	~10 A for 5 ms

Whenever cartridge modules are not used in the terminal box area, the trip unit can be supplied by means of a galvanically isolated 24V DC auxiliary voltage.

Protection trip units for power distribution

Ekip Touch

Characteristics

Ekip Touch is the new protection trip unit for SACE Emax 2 that provides a complete series of protections and high accuracy measurements of all electric parameters and can be integrated perfectly with the most common automation and supervision systems.

The simple and intuitive touch screen interface enables the operator to access all the information and settings rapidly and easily by minimizing installation and commissioning time.

The unit is available in the versions:

- Ekip Touch LI
- Ekip Touch LSI
- Ekip Touch LSI G



Key:

- | | |
|--|---|
| 1. Wide high-resolution color touch screen display | 4. Alarm LED |
| 2. Power-on LED to indicate correct operation (watchdog) | 5. Home pushbutton to return to home page |
| 3. Pre-alarm LED | 6. Pushbutton for test and indicating cause of trip |
| | 7. Test and programming connector |

Protection functions

Ekip Touch enables all the protection functions to be set with a few simple steps directly from the wide touchscreen display. If the circuit breaker is tripped it must be reset manually or electrically by the operator (lockout relay – code ANSI 86).

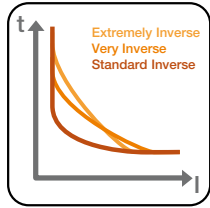

Overload (L - ANSI 49): available with three different types of trip curve:

1. $t = k/I^2$ with inverse long time;
2. IDMT in accordance with IEC 60255-3 for coordination with medium voltage protections, that are available according to the Standard Inverse (SI), Very Inverse (VI) and Extremely Inverse (EI) curves;
3. with $t = k/I^4$ curve for better coordination with upstream circuit breakers or with fuses.

The thresholds can be fine tuned (for example 1A for circuit breaker E1.2 1000A) and the timings to the second can be set directly from the display. The settable pre-alarm indicates the set threshold is reached before the protection is tripped. The protection can be disabled by rating plug L=off.

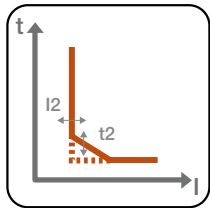

Time-delayed overcurrent (S - ANSI 51 & 50TD): with constant trip time ($t = k$), or constant specific let-through energy ($t = k/I^2$).

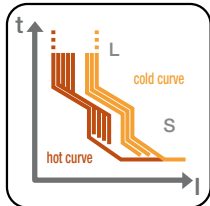

Thermal memory: for protections L and S it is used to protect the components, such as transformers, against overheating following overloads. The protection adjusts the trip time of the protection according to how much time has elapsed after the first overload, taking account of the overheating caused.

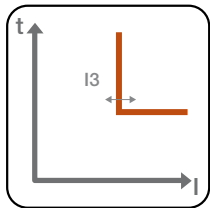

Instantaneous overcurrent (I - ANSI 50): with trip curve without intentional delay.

Closing on short-circuit (MCR): the protection uses the same algorithm of the protection I, limiting operation to a settable time window from the closing of the circuit breaker. The protection can be disabled, also alternatively to protection I. The function is active with an auxiliary supply.

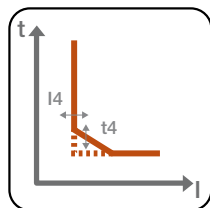

Ground fault (G - ANSI 51N & 50NTD): with trip time independent of the current ($t = k$) or with constant specific let-through energy ($t = k/I^2$). A pre-alarm indication is also available when 90% of the threshold is reached to activate corrective measures before the protection is tripped. The function also enables the trip to be excluded so that only the alarm is indicated, for use in installations where continuity of service is an essential requirement.

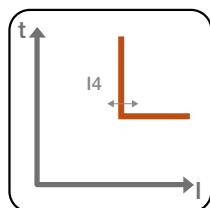

Instantaneous ground fault (G - ANSI 50N): with trip curve without intentional delay.

Protection trip units for power distribution

Ekip Touch

3

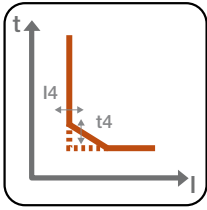

Ground fault on toroid (G ext - ANSI 51G & 50GTD): with trip time independent of the current ($t = k$) or with constant specific let-through energy ($t = k/I^2$). Pre-alarm that 90% threshold has been reached permit the fault to be reported to supervision systems without interruption of continuity. The protection uses the external toroid installed, for example, on the star centre of the transformer, and is an alternative to the G and Rc functions. The function is active with an auxiliary supply.

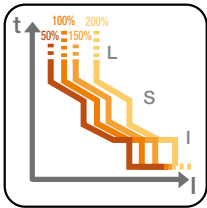

Neutral protection: available at 50%, 100%, 150% or 200% of the phase currents, or disabled, it is applied to the overcurrent protections L, S and I.

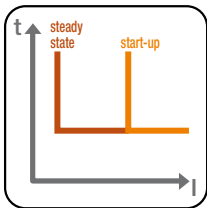

Start-up function: enables protections S, I and G to operate with higher trip thresholds during the starting phase, avoiding untimely trips due to high inrush currents of certain loads (motors, transformers, lamps). The starting phase lasts 100 ms to 30 s and is recognized automatically by the trip unit:

- at the closing of the circuit breaker with a self-supplied trip unit;
- when the peak value of the maximum current exceeds the set threshold ($0.1 \dots 10 \times I_n$) with an externally supplied trip unit; a new start-up is possible after the current falls below the threshold.

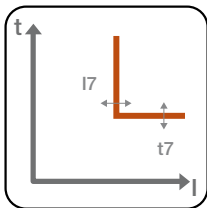

Current imbalance (IU - ANSI 46): with constant trip time ($t = k$), protects from an imbalance between the currents of the single phases protected by the circuit breaker.

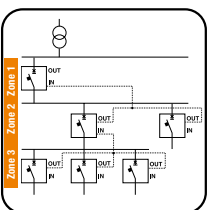

Zone selectivity for S and G protection (ANSI 68): can be used to minimize circuit breaker trip times closest to the fault. The protection is provided by connecting all the zone selectivity outputs of the trip units belonging to the same zone and feeding this signal to the trip unit input that is immediately upstream. Each circuit breaker that detects a fault reports it to the circuit breaker upstream; the circuit breaker that detects the fault but does not receive any communication from those downstream opens without waiting for the set delay to elapse. It is possible to enable zone selectivity if the fixed-time curve has been selected and the auxiliary supply is present.

Current thresholds: this function enables the realization of four independent thresholds to be indicated in order to enable corrective action implementation before the overload L protection trips the circuit breaker. For example, by disconnecting loads located downstream of the circuit breaker that are controlled by Ekip Signalling.

Power Controller: Power controller function (optional) with Ekip Measuring module.

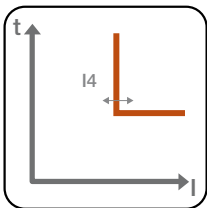

Second protection against instantaneous overcurrent (2I): the function is supplied as standard on all Ekip Touch and Hi-Touch versions. It is an instantaneous protection that permits opening of the circuit breaker faster than the standard I protection. It is independent from ANSI 50, with predetermined thresholds and is a temporarily activation. It can be activated for different uses in three ways:

- locally, directly on the input on the Ekip display unit
- remotely, via any Ekip Com module connected to the circuit breaker
- remotely, via a switch wired through an Ekip Signalling module.

When active, the Ekip display unit will show a confirmation of the activation and a red LED alarm will flash on the diagnosis bar.

Protection functions with Ekip Measuring Pro



1SDC2000467F001

The Ekip Touch protection functions can be further increased by using the Ekip Measuring Pro measuring and protection module. With this module, all the protection functions linked to voltage, frequency and power can be enabled, thus making Ekip Touch a multifunction unit that can measure, control and protect even the most complex installation.

A different operating mode can be chosen for each protection function:

1. Active: protection enabled by opening of the circuit breaker when the threshold is reached;
2. Only alarm: protection active, with only alarm indication when the threshold is reached;
3. Deactivated: protection disabled.

Furthermore, when the voltage and frequency protections are activated, they indicate an alarm status even when the circuit breaker is open so that a fault can be identified before the circuit breaker closes.

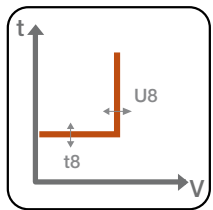

Undervoltage (UV - ANSI 27): with constant trip time ($t = k$), function is tripped when phase voltage falls below set threshold.

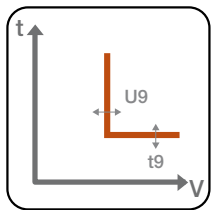

Overvoltage (OV - ANSI 59): with constant trip time ($t = k$), function is tripped when phase voltage exceeds the set threshold.

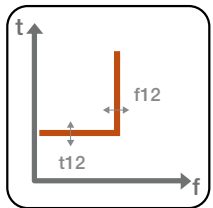

Underfrequency (UF - ANSI 81L): with constant trip time ($t = k$), function is tripped when network frequency falls below set threshold.

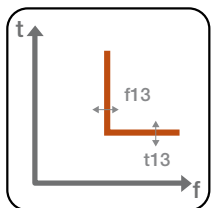

Overfrequency (OF - ANSI 81H): with constant trip time ($t = k$), function is tripped when network frequency exceeds the set threshold.

Protection trip units for power distribution

Ekip Touch

3

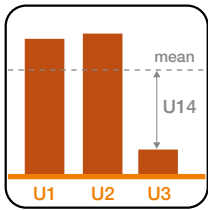

Voltage imbalance (VU – ANSI 47): with constant trip time ($t = k$), protects against an imbalance between the voltages of the individual phases that are protected by the circuit breaker.

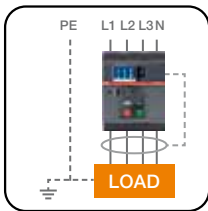

Residual current (Rc – ANSI 64 & 50NDT): with constant temperature ($t=k$) protects against indirect contacts and is integrated into Ekip Touch by a dedicated residual current rating plug and external toroid. The protection is an alternative to the functions G and Gext.

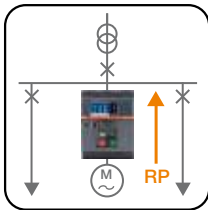

Reverse active power (RP - ANSI 32R): with constant trip time ($t = k$), function is tripped when total active power – in the opposite direction of the current - exceeds the set threshold.

In addition to the protection functions, the following indication and control functions are available to warn the user that a given condition has been reached. The active indications are always shown on the display and are also available by communication on the system bus (with Ekip Com modules) or electrical indication (with Ekip Signalling modules).

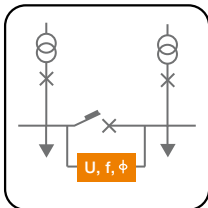

Synchrocheck (SC - ANSI 25): the synchronism control function compares the voltages in the module, the frequency and phase of the two circuits to which the circuit breaker is connected. Ekip Touch indicates that conditions have been reached that enable the two lines to be made parallel. The function is available with two work modes:

- In systems with both busbars supplied, where synchronism is determined by:
 1. voltage of the two half-busbars above the U_{live} threshold for the set time
 2. difference of the module of the two voltages below the threshold ΔU
 3. difference of the frequency of the two voltages below the threshold Δf
 4. difference of the phase of the two voltages below the threshold $\Delta \Phi$
 5. desirable time for synchronism condition t_{syn}
 6. circuit breaker open
- In systems with an out-of-service line (dead busbar), where the synchronism condition is determined by the concurrence of the following conditions for the t_{ref} set time:
 1. voltage of the active half-busbar above threshold U_{live}
 2. voltage of the dead half-busbar below threshold U_{dead}
 3. circuit breaker open

In both cases, synchronism consent is withdrawn when one of the above conditions is missing and it has not been less than 200ms from the change of the circuit breaker condition (when the relationship has been set). The indication of reached synchronism is available directly as an electrical indication via a contact that is always supplied with the module. The function can be activated simply by connecting the Ekip Synchrocheck module to any Ekip Touch provided with an Ekip Measuring Pro module.

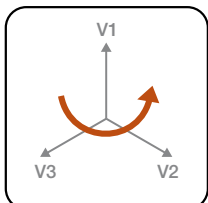

Cyclical direction of the phases (ANSI 47): indicates an alarm through inversion of the phases sequence.

Power factor (ANSI 78): available with a three-phase threshold, warns when the system operates with a power factor that is less than the set power factor.

Measurements



Measurements and meters

All versions of the Ekip Touch unit measure the RMS value of the currents of the three phases (L1, L2, L3) and of neutral (Ne) with 1% accuracy in the 0.2 to 1.2 I_n range (class 1 in accordance with IEC 61557-12). The complete range of measurement is from 0.03 to 16x I_n , where I_n is the value of the rating plug. The display shows the current of the most loaded phase both in numeric and analogue format on an ammeter with a 0-125% I_n scale for rapid identification of the load of the circuit breaker.



Alternatively, bar graphs that show the currents of the three phases and of neutral on a 0-125% I_n scale in addition to the numeric value of the most loaded phase can be selected as the default page. The bar graphs are yellow in the event of a pre-alarm and red in the event of an overload to enable an irregular condition to be identified immediately.

Where applicable, the measurement of the ground fault current is shown on a dedicated page. The ammeter can operate both in self-supplied mode and with auxiliary voltage. In the latter case, the display always has back lighting and the ammeter is also active at currents below 100A.



Adding the Ekip Measuring or Ekip Measuring Pro module to Ekip Touch enables Ekip Touch to be used as a multimeter to measure the values of:

- Voltage: phase-phase, phase-neutral (accuracy 0.5%);
- Power: active, reactive, apparent (accuracy 2%);
- Energy: active, reactive, apparent (accuracy 2%);
- Frequency (accuracy 0.2%);
- Power factor by phase and total;
- Peak factor.

Maximum values and values register

The Ekip Touch unit is able to supply the measurement trend of certain parameters over a settable period of time such as: average power, maximum power, maximum and minimum current, maximum and minimum voltage. The values of the last 24 time intervals are recorded in the unit with a relative timestamp and can be consulted directly from the display or remotely using one of the available communication protocols. The communication can also be used to synchronize the recording time interval.

Data logger

Ekip Touch is always supplied with the exclusive Data Logger (register) function that stores with high sampling frequency the instantaneous values of all the measurements in two memory buffer registers. The data can be easily downloaded by the Ekip Connect unit and transferred to any personal computer. This enables the current and voltage waveforms to be analyzed for rapid fault analysis. The function continuously stores and stops recording, with a selectable delay, whenever the event set by the user occurs (e.g. trip or alarm). In this manner, it is possible to analyze the complete evolution of the fault: from the start to its complete elimination.

Protection trip units for power distribution

Ekip Touch

3

Information on trip and opening data

If a trip occurs, Ekip Touch stores all the information that is required for rapid identification and elimination of the causes:

- Protection tripped
- Opening data (current, voltage or frequency)
- Time-stamping (data, time and consecutive opening number)

If the iTest key is pressed, the trip unit displays all these data directly on the display. No auxiliary supply is required. The information is also available to the user with the circuit breaker open or without current flow, due to the battery installed inside the unit.



Maintenance indicators

A complete set of information about the circuit breaker and its operation is available for effective fault analysis and preventive scheduling of maintenance. All the information can be seen from the display or from a PC using a communication unit.

In particular:

- Date, time, fault current by phase and type of protection tripped over the last 30 trips;
- Date, time and type of operation of the last 200 events (example: opening/closing of the circuit breaker, pre-alarms, editing of settings, ect.);
- Number of operations of the circuit breaker: divided into mechanical operations (no current), electrical operations (with current) and protection function (trip);
- Contact wear (endurance) estimated in function of the number and type of openings;
- Total operating time of the circuit breaker with circulating current;
- Date and time of the last maintenance session, scheduling of the next maintenance session;
- Circuit-breaker identifying data: type, serial number, firmware version, device name assigned by the user.

All the information can be viewed directly from the display and from a Smartphone, Tablet (with Ekip Bluetooth) or PC using the front port of the trip unit or the system communication.

Watchdog

All of the trip units in the SACE Emax 2 family ensure high reliability because of an electronic circuit that periodically controls continuity of the internal connections, such as trip coil, rating plug and each current sensor (Ansi 74). In the event of an alarm, a message is shown on the display, and if it is set during the installation phase, the trip unit can command the opening of the circuit breaker. If a protection function intervenes, Ekip Touch always checks that the circuit breaker has been opened by auxiliary contacts that indicate the position of the main contacts. Otherwise, Ekip Touch indicates an alarm (ANSI BF code - Breaker Failure) to be used to command the opening of the circuit breaker located upstream.

Ekip also contains self-protection that preserves the correct operation of the unit against abnormal temperatures (OT) inside the protection trip unit. The user disposes of the following indications or controls:

- "Warning" LED for temperature below -4°F/-20°C or above 158°F/70°C, at which the trip unit operates correctly with the display switched off
- "Alarm" LED for temperature outside the operating range, at which the trip unit commands the opening of the circuit breaker (if set during the configuration phase).

User interface



All Ekip Touch operations are simple and intuitive due to the wide graphic color touchscreen display. For example, all the main information is listed on one page (settable by default), thus enabling the state of the installation to be identified rapidly: maximum current, maximum voltage, active, reactive, apparent power and energy. In addition, the use of Ekip Touch is further simplified by the possibility of scrolling through the menu and reading the alarms in one of the languages that can be set directly from the display: Italian, English, German, French, Spanish, Portuguese, Chinese, Russian, Turkish and Thai.

The home pushbutton enables you to return, at any moment, to the main page and the iTest key enables the information to be viewed after a circuit breaker trip or test.

As in the previous generation of trip units, a password system is used to manage "Read" or "Edit" modes. The default password, 00001, can be edited by the user. The protection parameters (curve and trip thresholds) are settable in "Edit" mode whereas it is always possible to consult the information in "Read" mode.



On the front of the trip unit there are also two LEDs: a pre-alarm LED (square yellow LED) and an alarm LED (red triangular LED); a message on the display always accompanies the flashing of the LEDs for clear identification of the type of event. The list of all the alarms active at that moment can be viewed by simply touching the display on the white strip in the bottom left of the alarms zone.

Ekip Touch is also supplied with a front port that permits a temporary connection to devices for test, supply or communication (for example Ekip T&P).

Protection trip units for power distribution

Ekip Touch

Communication

Communication modules that can be installed inside the circuit breaker enable Ekip Touch to be integrated into the most modern supervision systems with protocols:

- IEC 61850
- Modbus TCP
- Modbus RS-485
- Profibus
- Profinet
- DeviceNet
- EtherNet/IP

The integration into communication systems enables measurements, statuses and alarms to be programmed and viewed by remote functions. If the circuit breaker has to be opened and closed remotely, the Ekip Com Actuator module can be installed in the circuit breaker front, in the right-hand accessories chamber.

For each circuit breaker, several communication modules with different protocols can be used simultaneously; for example, this enables the circuit breaker to be connected to the Ekip link system to obtain local supervision from the front of the switchgear and to simultaneously integrate it into a communication network. In addition, for applications requiring very high reliability, up to two modules of the same protocol can be inserted by use of the redundant version that enables two different addresses to communicate on the same bus.

Test function

For testing the circuit breaker, it is possible to use the test port and the iTest key positioned on the front of the protection trip unit. The available functions are:

- trip test, test of the display and of the LEDs and check of absence of alarms detected by the watchdog function using Ekip TT (always supplied with Ekip Touch);
- test of the single protection functions and saving of the report, in addition to the trip test and test of the display, using Ekip T&P;
- test of the battery with the circuit breaker switched off by pressing the iTest key.

Supply

The Ekip Touch protection trip unit is self-supplied by the current sensors and does not require an external supply for the basic protection functions or for the alarm indication functions. All protection settings are stored in a non-volatile memory that maintains the information, even without a power supply. To activate the indication functions the ammeter and the display, a 100A three-phase current suffices.

An auxiliary supply can easily be connected. The Ekip Supply module can be connected to supplies of both direct current and alternating current to activate additional functions such as:

- using the unit with circuit breaker open;
- using additional modules such as Ekip Signalling and Ekip Com;
- connection to external devices such as Ekip Multimeter and Ekip Control Panel;
- recording the number of operations;
- G protection with values below 100A or below 0.2 In;
- zone selectivity;
- Gext and MCR protection functions.

Supply	Ekip Supply	
Nominal voltage	24-48V DC	110-240V AC/DC
Voltage range	21.5-53V DC	105-265V AC/DC
Rated power (including modules)	10W max.	10W max.
Inrush current	~10 A for 5 ms	~10 A for 5 ms

The Ekip Supply module allows the cartridge modules to be used in the terminal box area. Otherwise, the trip unit can be supplied by means of a galvanically isolated 24 VDC auxiliary voltage.

The Ekip Measuring Pro module can supply the Ekip Touch trip unit with line voltage above 85V. In addition, if the module is installed with voltage pick-ups on the supply side, the trip unit can be used even if the circuit breaker is open.

The Ekip Touch protection trip unit is also supplied with a battery that enables the cause of the fault to be indicated after a trip, without a time limit. In addition, the battery enables date and time to be updated, thus ensuring the chronology of the events. When Ekip Touch is operating, it uses an internal control circuit to indicate automatically that the battery is flat. On the other hand, when the unit is switched off the battery test can be run by simply pressing the iTest key.

Protection trip units for power distribution

Ekip Hi-Touch

Characteristics

The Ekip Hi-Touch of SACE Emax 2 is a high-performance multifunction unit that is extraordinarily versatile and can be used in even the most complex installations. Ekip Hi-Touch, in fact, features exclusive functions such as: directional protection, restricted ground fault and dual setting of the protections. In addition, Ekip Hi-Touch is supplied with the exclusive Network Analyzer function that can monitor the quality of the power absorbed by the installation in accordance with IEEE 1159 and IEEE 1250.

Ekip Hi-Touch boasts all the features of Ekip Touch; as standard, it features the measuring and protection module Ekip Measuring Pro and can also be fitted, like Ekip Touch, with the additional features provided by the internal modules and by the external accessories.

The front interface of the unit, which is common to Ekip Touch, is extremely simple to use because of the touchscreen color display; it is able to show measurements, bar graphs and sine curves of the different electrical values.

The unit is available in the versions:

- Ekip Hi-Touch LSI
- Ekip Hi-Touch LSI G

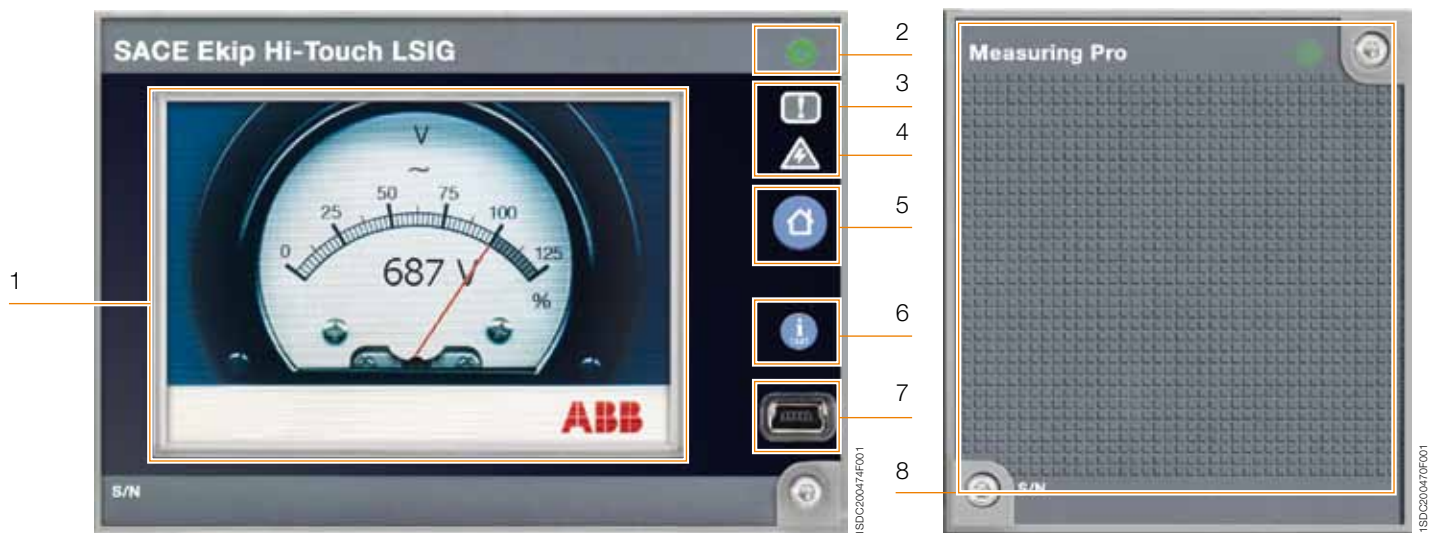

Key:

- | | |
|--|---|
| 1. Wide high-resolution color touch screen display | 5. Home pushbutton to return to home page |
| 2. Power-on LED indicating correct operation | 6. Pushbutton for test and for indicating cause of the trip |
| 3. Pre-alarm LED | 7. Test and programming connector |
| 4. Alarm LED | 8. Ekip Measuring Pro module, with relative LED power on |

Protection functions

The Ekip Hi-Touch trip unit shares the following protection functions with Ekip Touch:

- Overload (L – ANSI 49);
- Time-delayed overcurrent (S – ANSI 51 & 50TD);
- Thermal memory;
- Instantaneous overcurrent (I – ANSI 50);
- Closing on short-circuit (MCR);
- Ground fault (G – ANSI 51N & 50NTD);
- Instantaneous ground fault (G - ANSI 50N);
- Ground fault on toroid (G ext – ANSI 51G & 50GTD)
- Neutral protection;
- Start-up function;
- Zone selectivity for functions S and G (ANSI 68);
- Current imbalance (IU – ANSI 46);
- Undervoltage (UV – ANSI 27);
- Overvoltage (OV – ANSI 59);
- Underfrequency (UF – ANSI 81L);
- Overfrequency (OF – ANSI 81H);
- Voltage imbalance (VU – ANSI 47);
- Residual current (Rc – ANSI 64 & 50NTD);
- Reverse active power (RP – ANSI 32R);
- Synchrocheck (SC – ANSI 25, optional);
- Cyclical direction of the phases (ANSI 47);
- Power factor (ANSI 78);
- Current thresholds;
- Power Controller function (optional);
- Second protection against instantaneous overcurrent (2I).

The following protections are also available:

Second time-delayed overcurrent protection (S2 – ANSI 50TD): in addition to the standard protection S, a second (excludible) time-constant protection is available that enables two independent thresholds to be set in order to ensure precise selectivity, especially in highly critical conditions.

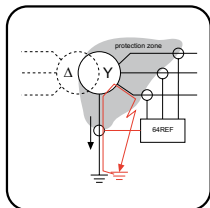

Second protection against ground fault (ANSI 50GTD/51G & 64REF): whereas with Ekip Touch the user has to choose between implementation of the protection G by internal current sensors (calculating the vector sum of the currents) or G ext external toroids (direct measurement of the ground fault current), Ekip Hi-Touch offers the exclusive feature of simultaneous management of both configurations by two independent ground fault protection curves. Owing to this characteristic, the trip unit is able to distinguish a non-restricted ground fault and then activate the opening of Emax 2, from a restricted ground fault, and to thus command the opening of the medium voltage circuit breaker.

Another possible configuration is with the residual current protection replacing the Gext protection, while the G protection remains active. The residual current protection is activated in the presence of the residual current rating-plug and of the toroid.

Protection trip units for power distribution

Ekip Hi-Touch

3

Directional overcurrent (D – ANSI 67): the protection is able to recognize the direction of the current during the fault period and thus detect if the fault is upstream or downstream of the circuit breaker. The protection, with fixed time trip curve ($t=k$), intervenes with two different time delays (t_{7bw} and t_{7fw}), according to the current direction. In ring distribution systems, this enables the distribution portion to be identified in which the fault occurred and to disconnect it while maintaining the operation of the rest of the installation.

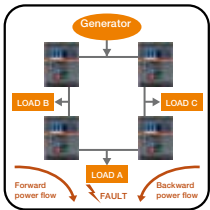

Zone selectivity for protection D (ANSI 68): enables the possibility to connect circuit breakers among them, that in case of fault rapidly isolate the fault area, disconnecting the installation only at the level nearest to the fault, maintaining the operation of the rest of the installation. The function is particularly useful in ring and grid installations where, in addition to the zone, it is also essential to define the flow direction of the power that supplies the fault. It is possible to enable directional zone selectivity alternatively to the zone selectivity of the protections S and G, and in the presence of an auxiliary supply.

Start-up function for protection D: enables higher trip thresholds to be set at the outgoing point, as available for protections S, I and G.

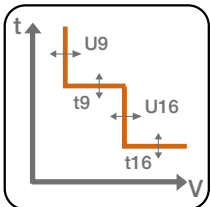

Second protection against undervoltage and overvoltage (UV2 and OV2 – ANSI 27 and 59): enables two minimum and maximum voltage thresholds to be set with different delays in order to be able to discriminate, for example, between voltage dip transients due to the start-up of a motor and an actual fault.

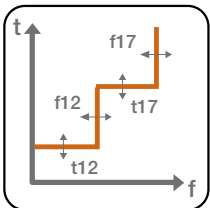

Second protection against underfrequency and overfrequency (UF2 and OF2 – ANSI 81L and 87H): enables two minimum and maximum frequency thresholds to be set simultaneously. For example, only an alarm can be set to be tripped when the first threshold is reached, and the circuit breaker can be set to be opened when the second threshold is reached.

Dual setting of protections: Ekip Hi-Touch can store a set of alternative parameters for all protections. This second series (set B) can replace, if necessary, the default series (set A) by an external control. The control can be given when the network configuration is edited, for example when an emergency source is activated in the system, changing the load capacity and the short-circuit levels. Another typical application is protecting the operator opposite the switchgear against the electric arc. In this case, protection delays are minimized to safeguard the operator (Set A), whereas in the absence of an operator the protections are set to ensure selectivity with the circuit breakers downstream (Set B). It is possible to activate series B by:

- Digital input available with an Ekip Signalling module;
- Communication network, by means of one of the Ekip Com communication modules;
- Directly from the Ekip Hi-Touch display;
- By a settable internal time, after the circuit breaker has closed.

Measurements

The Ekip Hi-Touch trip unit offers a complete series of measurements, common to Ekip Touch:

- Measurements and counters: currents, voltage, power, energy;
- Maximum values and value log;
- Data logger;
- Information on the trip and opening data;
- Maintenance indicators.

Ekip Hi-Touch integrates the exclusive **Network Analyzer** function, which analyzes the quality of energy consumed by the installation, in accordance with the provisions of international standards EN50160, IEC 61000-4-30, IEEE 1159 and IEEE 1250, in terms of harmonic content, average value and long or short term changes in voltage. Changes in the quality of energy can cause malfunctions in the switchgear and a reduction in their lifespan, as well as increasing losses and reducing the energy efficiency of the installation.

It is therefore increasingly important to assess the quality of the energy and the economic impact it has on the productive process, so that the appropriate preventive and corrective actions can be taken. With Ekip Hi-Touch, the causes of an increase in power lost in transformers or motors, or a reduction in the lifespan of cables and capacitors, can be identified without the need to install any external instrumentation.

The Network Analyzer function performs continuous monitoring of the quality of energy, and shows all results through a display or communication module. In particular:

- **Hourly average voltage value:** in accordance with international standards, this must remain within 10% of the rated value, but different limits can be defined according to the needs of the installation. The positive sequence voltage is obtained from the three line voltages and compared with the limits. If the limits are exceeded, Ekip Hi-Touch generates a signalling event. The quantity of these events is stored in a counter. The counter values are available for each of last 7 days, as well as the total. The measures available are the positive and negative sequence voltages and positive and negative sequence currents of the last interval monitored. The interval calculation time of the average values can be set between 5 minutes and 2 hours.
- **Interruptions / short dips in voltage** (voltage interruptions / voltage dip): if the voltage remains below the threshold for more than 40ms, Ekip Hi-Touch generates an event that is counted in a dedicated log. The voltage is monitored on all lines.
- **Short voltage spikes** (voltage transients, spikes): if the voltage exceeds the threshold for 40ms, set for a pre-determined time, Ekip Hi-Touch generates an event that is counted.
- **Slow voltage sags and swells** (voltage sag / voltage swell): when the voltage goes outside the range of acceptable limit values for a time greater than the one set, Ekip Hi-Touch generates an event that is counted. Three values can be configured for voltage sags and two for voltage swells, each of which associated to a time limit: this enables us to verify whether the voltage remains within a curve of values that are acceptable by equipment such as computers. The voltage is monitored on all lines.
- **Voltage imbalances:** if the voltages are not equal or the phase displacements between them are not exactly 120°, an imbalance occurs, which is manifested with a negative sequence voltage value. If this limit exceeds the threshold value set, an event is stored which is counted.
- **Harmonic analysis:** the harmonic content of voltages and currents, measured to the 50th harmonic, as well as the value of total harmonic distortion (THD), is available in real time on the display or through the communication modules. Ekip Hi-Touch also generates an alarm if the THD value or the magnitude of at least one of the harmonics exceeds the values set. The voltage is monitored on all lines and currents on all phases.

All information can be displayed directly on the screen or on a smartphone, tablet or PC using the front port of the trip unit (with Ekip Bluetooth) or installation communication.

Other functions

Ekip Hi-Touch integrates all the features in terms of user interface, communication, test and supply described for Ekip Touch equipped with Ekip Measuring Pro.

Protection trip units for generators

Ekip G Touch

Characteristics

Ekip G Touch by SACE Emax 2 is the new protection trip unit designed for use in applications with generators, such as Genset, cogeneration and marine applications, in conformity to international standards IEC 60034-1 and IEEE C37.102. Ekip G Touch has been approved by the main shipping registers and enables the number of components installed, such as external protection devices, current sensors, voltage transformers and the relative cabling, to be reduced. The reductions allow the installation to be significantly simplified. In addition, all the protection functions can be tested individually, using the Ekip T&P device that enables the function to be tested before commissioning.

The unit is available in the Ekip G Touch LSIG version and features all the characteristics provided by Ekip Touch. The Ekip Measuring Pro measuring and protection module is supplied as standard and, like Ekip Touch; the functions can be increased further using the internal modules and the external accessories.

The front interface of the unit, which is common to the Ekip Touch family, is characterised by a wide, high resolution touchscreen display that is simple to use and displays measurements and alarms clearly and accurately.

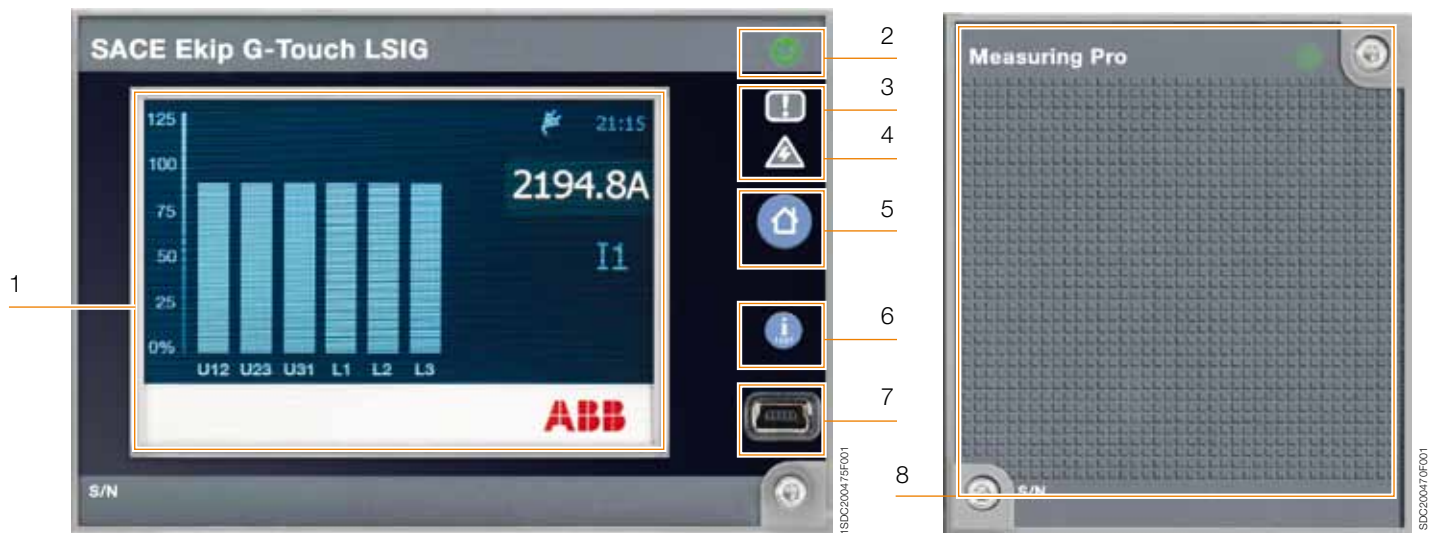

Key:

- 1. Wide, high resolution touchscreen display
- 2. Power-on LED indicating correct operation
- 3. Pre-alarm LED
- 4. Alarm LED
- 5. Home pushbutton to return to home page
- 6. Pushbutton for test and for indicating cause of the trip
- 7. Test and programming connector
- 8. Ekip Measuring Pro module with relative power-on LED

Protection functions

The Ekip G Touch trip unit provides all the protection functions of Ekip Touch and, in addition, provides a series of dedicated generator protections. If Ekip G is tripped, it opens the circuit breaker and prevents it from closing again until it has been reset manually or electrically by the operator (lockout relay – code ANSI 86).

The trip unit is provided with the following protection functions:

- Overload (L – ANSI 49);
- Time-delayed overcurrent (S – ANSI 51 & 50TD);
- Thermal memory;
- Instantaneous overcurrent (I – ANSI 50);
- Closing on short circuit (MCR);
- Ground fault (G – ANSI 51N & 50NTD);
- Instantaneous ground fault (G - ANSI 50N);
- Ground fault on toroid (G ext – ANSI 51G & 50GTD);
- Neutral protection;
- Start-up function;
- Zone selectivity for functions S and G (ANSI 68);
- Current imbalance (IU – ANSI 46);
- Undervoltage (UV – ANSI 27);
- Overvoltage (OV – ANSI 59);
- Underfrequency (UF – ANSI 81L);
- Overfrequency (OF – ANSI 81H);
- Voltage imbalance (VU – ANSI 47);
- Differential ground fault (Rc – ANSI 87N);
- Reverse active power (RP – ANSI 32R);
- Synchrocheck (SC – ANSI 25, optional);
- Cyclical direction of phases (ANSI 47);
- Power factor (ANSI 78);
- Current thresholds;
- Power Controller function (optional);
- Second protection against instantaneous overcurrent (2I).

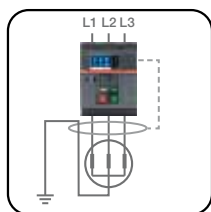

The following protection is also available:

Differential ground fault (Rc - ANSI 87N): protects against internal ground fault on generator winding. It is required that the toroid hugs the active conductors and the ground conductor. Rc protection is integrated by a dedicated residual current rating plug and the external toroid.

Protection trip units for generators

Ekip G Touch

The specific functions for generator protections are described below, for each of which it is possible to choose the operating mode: active, only alarm or deactivated. All the voltage and frequency protections also operate when the circuit breaker is open, enabling the fault to be identified before the closing of the circuit breaker.

3

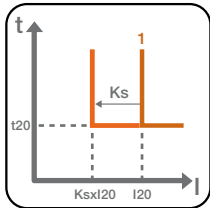

Voltage controlled overcurrent protection (S(V) - ANSI 51V): protection from maximum current with constant trip time ($t = k$) that is sensitive to the voltage value. The set current threshold, following a voltage drop, decreases by steps or linearly.

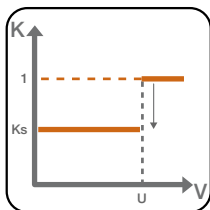

In step mode (controlled mode) the protection is tripped at the set threshold (I_{20}) if the voltage is above U , whereas it is tripped at the lower threshold of the factor K_s ($I_{20} * K_s$) if the voltage is below U .

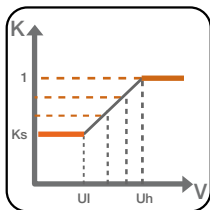

On the other hand, in linear mode (restrained mode) two voltage limits are selected within which the protection is tripped at the set threshold (I_{20}) reduced by the factor K corresponding to the measured voltage. The variation of the factor K is proportional to the voltage, and for voltages greater than the upper threshold (U_h) the threshold I_{20} works, whereas for voltages below the lower threshold (U_l) the minimum threshold ($I_{20} * K_s$) applies.

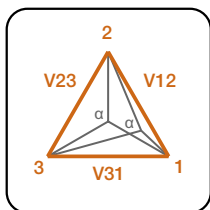

Residual overvoltage (RV - ANSI 59N): with constant trip time ($t = k$), protects against insulation loss in systems with insulated neutral or with neutral earthed with impedance.

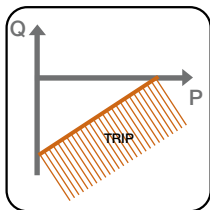

Loss of field or reverse reactive power (RQ – ANSI 40 or 32RQ): with constant trip time ($t = k$), is tripped when the total reactive power absorbed by the generator exceeds the set threshold. It is possible to select the constant threshold ($k=0$) or a function of the delivered active power of the generator ($k \neq 0$).

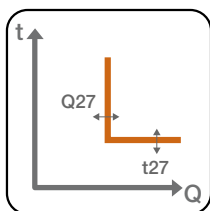

Reactive overpower (OQ – ANSI 32OF): with constant trip time ($t = k$), the function is tripped when reactive power exceeds the set threshold in the generator to network direction.

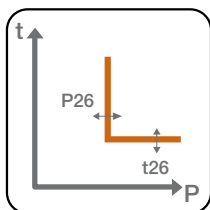

Active overpower (OP – ANSI 32OF): with constant trip time ($t = k$), the function is tripped when the active power exceeds the threshold set in the delivering direction of the generator.

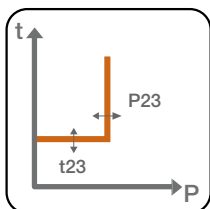

Active underpower (UP – ANSI 32LF): with constant trip time ($t = k$), the function is tripped when the active power delivered by the generator is lower than the set threshold. It is possible to disable the protection temporarily, to manage the start-up phase, by setting a time window from the closing of the circuit breaker, by using an electric signal or via incoming communication to a relay.

Protection trip units for generators

Ekip G Touch

Measurements

The Ekip G Touch trip unit provides a complete series of measurements, which are common to Ekip Touch:

- Measurements and meters: currents, voltage, power, energy, frequency;
- Maximum values and values register;
- Data logger;
- Information on trip and opening data;
- Maintenance indicators.

3

All the information can be viewed directly from the display of the trip-unit, by means of the external Ekip Multimeter display or by Smartphone, Tablet or PC using the front port of the trip unit (with Ekip Bluetooth) or the system communications.

Other functions

Ekip G Touch provides the same characteristics in terms of user interface, communication, test and power supply described for Ekip Touch equipped with Ekip Measuring Pro.

Protection trip units for generators

Ekip G Hi-Touch

Characteristics

SACE Emax 2's Ekip G Hi-Touch is the new benchmark for the protection of low voltage electric generators. It provides optimum protection, even in complex installations, due to exclusive functions such as protection against frequency creep and maximum directional current.

Ekip G Hi-Touch, like all Hi-Touch trip units, is supplied as standard with the Ekip Measuring Pro measuring and protection module and enables an independent second set of protections to be set. In addition, the Network Analyzer function enables it to monitor the quality of the power delivered by the generator.

Ekip G Hi-Touch is available in the LSIG version and ensures all the protection, measuring and control functions of Ekip Hi-Touch and the specific protections for Ekip G Touch generators. The user interface and the accessories are common to the rest of the family.



Key:

1. Wide, high resolution touchscreen display
2. Power-on LED indicating correct operation
3. Pre-alarm LED
4. Alarm LED
5. Home pushbutton to return to home page
6. Pushbutton for test and for indicating cause of the trip
7. Test and programming connector
8. Ekip Measuring Pro module with relative power-on LED

Protection trip units for generators

Ekip G Hi-Touch

Protection functions

The Ekip G Hi-Touch trip unit is provided with the following protection functions, common to Ekip Hi-Touch:

- Overload (L – ANSI 49);
- Time-delayed overcurrent (S – ANSI 51 & 50TD);
- Time-delayed overcurrent, second threshold (S2 – ANSI 50TD);
- Thermal memory;
- Instantaneous overcurrent (I – ANSI 50);
- Directional overcurrent (D – ANSI 67);
- Voltage controlled overcurrent protection (S(V) – ANSI 51V);
- Closing on short circuit (MCR);
- Ground fault (G – ANSI 51N & 50NTD);
- Instantaneous ground fault (G - ANSI 50N);
- Second protection against ground fault (ANSI 50GTD/51G & 64REF);
- Ground fault on toroid (Gext – ANSI 51G & 50GTD);
- Neutral protection;
- Start-up function;
- Zone selectivity for functions S and G (ANSI 68);
- Zone selectivity for directional protection D (ANSI 68)
- Start-up function for protection D;
- Current imbalance (IU – ANSI 46);
- Undervoltage (UV – ANSI 27);
- Undervoltage, second threshold (UV2 – ANSI 27);
- Overvoltage (OV – ANSI 59);
- Overvoltage, second threshold (OV2 – ANSI 59);
- Underfrequency (UF – ANSI 81L);
- Underfrequency, second threshold (UF2 – ANSI 81L);
- Overfrequency (OF – ANSI 81H);
- Overfrequency, second threshold (OF2 – ANSI 81H);
- Voltage imbalance (VU – ANSI 47);
- Residual overvoltage (RV – ANSI 59N);
- Differential ground fault (Rc – ANSI 87N);
- Loss of field or reverse reactive power (RQ – ANSI 40 or 32R);
- Reverse active power (RP – ANSI 32R);
- Reactive overpower (OQ – ANSI 32OF);
- Active overpower (OP – ANSI 32OF);
- Active underpower (UP - ANSI 32LF);
- Synchrocheck (SC – ANSI 25, optional);
- Cyclical direction of phases (ANSI 47);
- Power factor (ANSI 78);
- Current thresholds;
- Dual setting of protections;
- Power Controller function (optional);
- Second protection against instantaneous overcurrent (2I).

In addition, the following protections are also available:

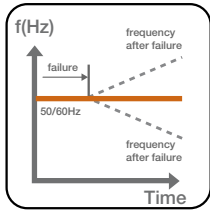

Rate of change of frequency (ROCOF – ANSI 81R): enables both positive and negative frequency variations to be detected rapidly. The protection is constant and is tripped when the frequency variation in Hz/s is greater than the set threshold.

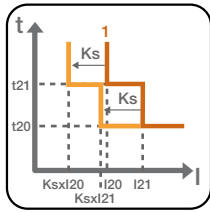

Second protection against voltage controlled overcurrent protection (S2(V) - ANSI 51V): available in addition to the protection S(V), enables total selectivity to be achieved in all installations.

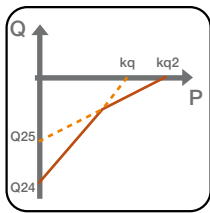

Second protection against loss of field or reverse reactive power (RQ – ANSI 40 or 32R): enables the generator’s de-energization curve to be followed very accurately, thereby avoiding any unnecessary disconnection.

Measurements

The Ekip G Hi-Touch trip unit provides all the measurements available with Ekip Hi-Touch:

- Network Analyzer, in conformity to EN50160 and IEC 61000-4-30;
- Measurements and meters: currents, voltage, power, energy, frequency;
- Maximum values and values register;
- Data logger;
- Information on trip and opening data;
- Maintenance indicators.

Other functions

Ekip G Hi-Touch has all the features of Ekip Touch equipped with Ekip Measuring Pro in terms of user interface, communication, test and power supply.

Protection trip units for power control

Ekip Power Controller

The exclusive Ekip Power Controller function, patented by ABB and available on new SACE Emax 2 circuit breakers, monitors installation loads and generators, permitting the power consumed to be limited and allowing savings on electricity bills.

3

Ekip Power Controller, which can be used with all Ekip Touch trip units of the Emax 2 series, effectively helps to improve energy efficiency by managing the entire low voltage electrical system. It is, in fact, able to adapt the demand for power according to the availability of the energy source, the time of day and the costs indicated in the current pricing plan.

In this way Ekip Power Controller is able to maintain power consumption within the limits defined, thereby optimizing the costs of managing the installation and reducing emissions.

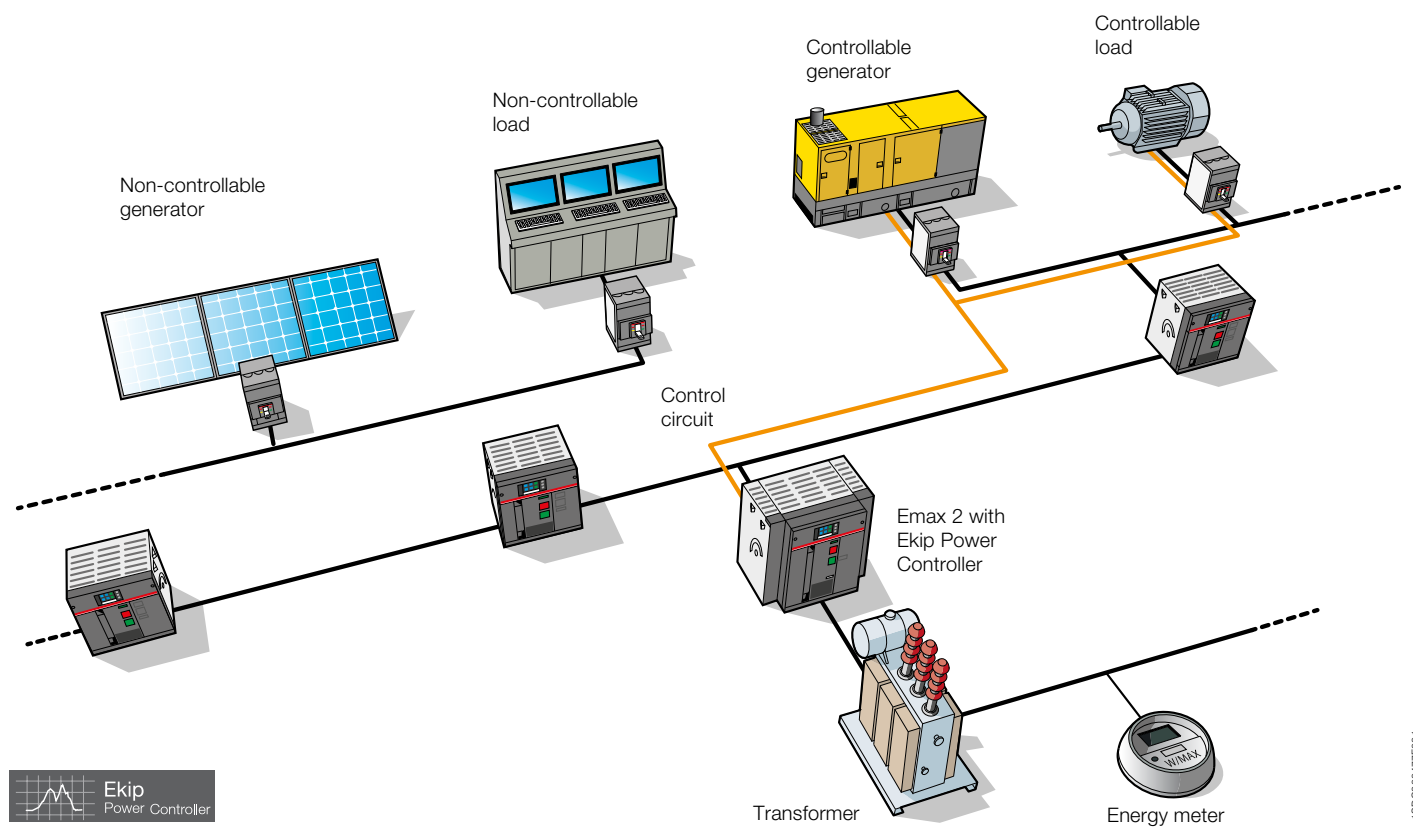

1SDC200477F001

Distinctive features

Reduction of energy costs with minimum impact. The loads are disconnected from the power supply for short periods, in the minimum number necessary and in a fixed order of priority, enabling power consumption peaks to be limited. This allows the contract drawn up with the energy provider to be renegotiated, reducing the power allocated, with a consequent reduction in total energy costs.

Power limited only when necessary. Ekip Power Controller manages up to four different time bands: it is therefore possible to respect a particular power limit according to whether it is during the day (peak) or night (off peak). In this way, consumption during the day when rates are at their highest can be limited.

Simple to install. Ekip Power Controller allows the installation to be managed efficiently with a simple architecture. Thanks to a patented design, it is sufficient to measure the total power of the installation without having to measure the power consumed by each load. Installation costs and times are thereby reduced to a minimum.

Ready to use. Ekip Power Controller does not require the writing, implementation and testing of complicated programs for PLCs or computers because the logic has already been implemented in the protection unit and is ready to use; it is sufficient to set the installation parameters from a smartphone or directly from the circuit breaker display.

Improvement of the efficiency of the electrical system. Ekip Power Controller significantly helps to flatten the load curve, limiting the use of peaking power plants in favor of base load power plants with greater efficiency.

Graph of daily load

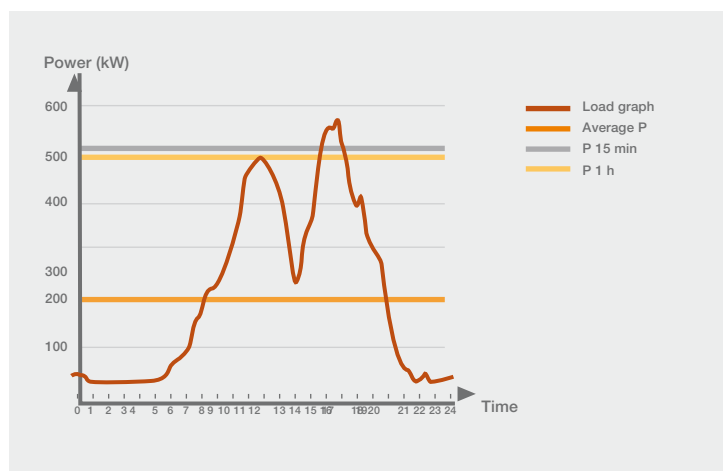

Perfect integration into intelligent networks. Because of integrated communication modules, Ekip Power Controller can receive the maximum absorbable power directly from the medium voltage control system, determining consumption for the next 15 minutes. Ekip Power Controller, according to the information received, manages the switching off of non-priority loads or the switching on of reserve generators. Ekip Power Controller gives maximum priority to non-programmable preferred energy sources, such as wind and solar, and they are therefore considered uninterruptable. In the event the production of internal power to the controlled network is reduced, due, for example, to decreased production of solar power, Ekip Power Controller will disconnect the necessary loads to respect the consumption limit set.

Perfect integration in self-generation systems. This benefit is used, for example, in installations with a system of cogeneration. Ekip Power Controller controls the total consumption drawn from the electrical network, interrupting non-indispensable loads when production is reduced and reconnecting them when generator power is sufficient to not exceed limits. There are multiple advantages: reduction in energy costs, maximum use of local production and greater overall energy efficiency.

Protection trip units for power control

Ekip Power Controller

Operating principle

Ekip Power Controller is an advanced system of control in real time that limits the average power consumed in each time range to a maximum, pre-determined value. This is achieved by delaying, only when necessary, the operation of controllable loads, which are then put back into operation as soon as possible without exceeding the limits of power set. In each instance, Ekip Power Controller optimizes the number of deactivated loads on the basis of a determined order of priority, constantly seeking to supply the most necessary part of the installation possible. If controllable generators are present such as, for example, diesel generators, Ekip Power Controller controls their switching on and off to limit the peak of power consumed. The types of loads that can be interrupted for a few minutes with a limited impact are many and vary according to the application, for example:

- industrial ovens, fridges;
- ventilation or air compression systems;
- electric car charging systems;
- electrical air conditioning/heating of corridors, stairways and passageways;
- electric kitchens in hotels/hospitals;
- swimming pool heating systems and circulation pumps.

The method of calculation

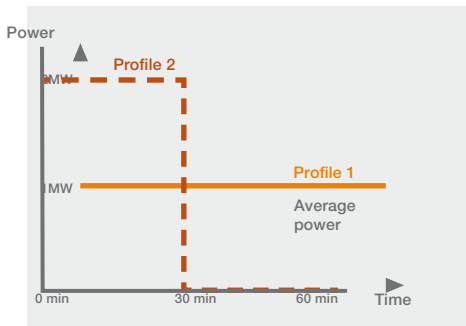

Ekip Power Controller controls the maximum power consumed by the installation, utilizing the same method as that used for fiscal metering, thereby achieving savings on the component connected to maximum power (\$/kW) on electricity bills. The power consumed is calculated by the energy meter as an average value over pre-determined time periods such as, 15 minutes, or even 1 hour. The user therefore pays the same bill both in the event that he consumes 1MW continuously (profile 1) or 2MW for 50% of the time and 0MW for the remaining 50% (profile 2), since the average power is the same.

Estimation of consumption

Ekip Power Controller uses this principle together with a predictive algorithm that estimates, moment by moment, power at the end of the period in order to decide whether to disconnect or connect loads and generators. This enables brief transient requests for high power to be tolerated, such as, for example, the starting up of motors, without causing the disconnection of loads as soon as the power exceeds the threshold set.

The operations of connection and disconnection therefore depend on the consumption from the beginning of the period up to the present moment: for example, if during the first few minutes of the period of reference consumption was very high, Ekip Power Controller will disconnect a greater number of loads in the minutes after; if, on the other hand, the initial consumption was low, it will leave a greater number of loads in operation.

Management of loads

According to the consumption estimate at the end of the period, Ekip Power Controller will take different actions:

- if the value estimated is greater than the power set as a target, Ekip Power Controller makes the decision to disconnect one of the loads controlled from the power supply, or to connect a generator;
- if the value estimated is equal or slightly less than the average power set as a target, Ekip Power Controller makes the decision to leave the conditions of the controlled loads and generators unchanged;
- if the value estimated is significantly lower than the average power set as a target, Ekip Power Controller makes the decision to reconnect one of the loads controlled to the power supply, or switch off a generator if one or more of these have been switched on previously.

This operation is carried out cyclically each time by calculating a new estimate: therefore, if the estimate of power consumed continues to be too high despite the fact that a load has been disconnected, Ekip Power Controller will proceed to disconnect another and so on, until the power limit is respected. In this way, the number of connected or disconnected loads varies dynamically, and always with the guarantee that only the minimum number needed to maintain the power limit are disconnected.

Priority of loads

If the decision made is to disconnect or re-connect one of the loads controlled, Ekip Power Controller proceeds according to an established order: the load indicated as the first will be that of least importance, or that for which a temporary period of deactivation is acceptable; the load indicated as the second will be the next one in order of importance, and so on. The loads that have been disconnected in that order will be re-connected in the reverse order, beginning with the load that is most important for the installation. In this way, the impact on the production process can be minimized, limiting the disconnection time for loads of the highest priority. Furthermore, by gradually connecting and disconnecting the loads in order of priority, voltage imbalances and consumption peaks that can affect the network are avoided.

Protection of the installation

Ekip Power Controller can be integrated perfectly into the installation's protection devices. In fact, if one of the controlled circuit breakers opens due to an overcurrent or by manual operation, Ekip Power Controller considers the load unavailable until the operator resets it, making it available again. In this way, safe operation of the installation is always guaranteed.

Protection trip units for power control

Ekip Power Controller

Architecture

Ekip Power Controller is installed on the main low voltage circuit breaker, immediately downstream of the transformer and energy meter. By using the high precision current and voltage sensors located inside the SACE Emax 2, it is able to measure the average power consumed by the installation, using the same method as that used for fiscal metering, over an established time period. To control this average power, Ekip Power Controller performs controlled opening and closing of the switching devices.

A Power Controller system consists of:

- a SACE Emax 2 circuit breaker with Ekip Touch protection trip unit equipped with Ekip Power Controller and Ekip Measuring. This circuit breaker is the power controller and meter, which implements the Power Controller function, determining the connection and disconnection of loads;
- up to 15 controlled loads and/or generators. The connection between Ekip Power Controller and users can be achieved:
 - with Ekip Signalling modules for connections inside the same switchboard. This allows circuit breakers or contactors installed on the power circuit to be commanded directly through available outputs. The opening and closing operations are always carried out in safety due to an input that receives feedback on the state of the controlled device.
 - with Ekip Signalling modules acting on the generator starting circuit or on the control circuit of the loads. This allows, the consumption of motors powered by drives to be reduced without interrupting the production cycle.
 - with Ekip Link communication modules for installations with circuit breakers in different switchboards. This enables wiring between switchboards to be simplified, requiring only one EtherNet cable.

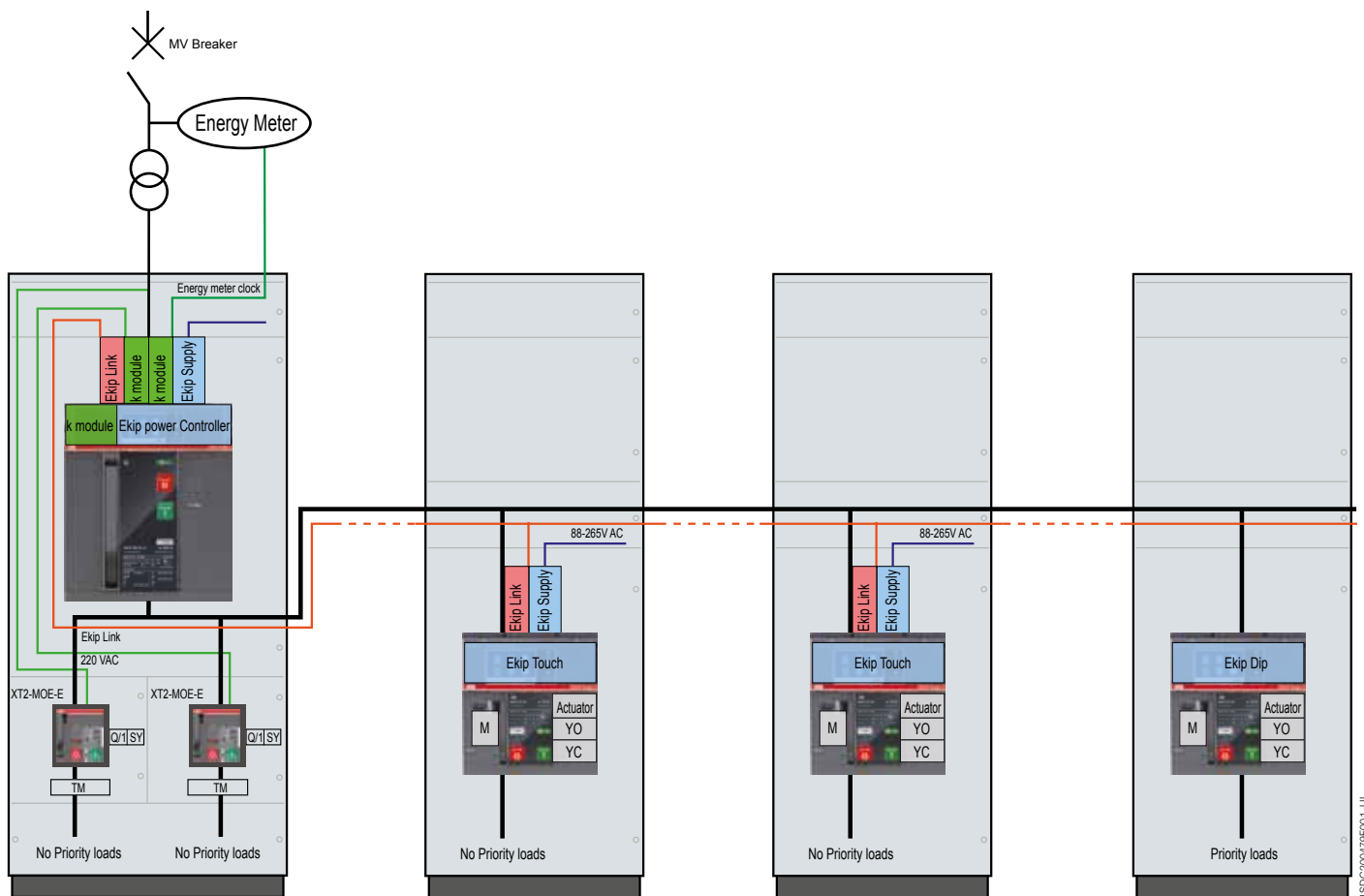

In the event that the installation is constructed with a single medium voltage delivery point and two or more transformers in parallel, Ekip Power Controller can acquire, via Ekip Link, the power measurement carried out by the other Emax 2 devices present. In this way the power limit can be respected at the medium voltage measuring point, without having to duplicate the control circuit of the loads.

Installation

Ekip Power Controller is not only simple to implement and use, it is also very flexible because of parameters which have been specially developed to satisfy the needs of all applications.

Installation parameters:

- Power limit: this is the average power that Ekip Power Controller respects, which can be selected in kW directly from the display.
- Evaluation window: this is the period in which the distributor of electrical energy evaluates the maximum power, which can be selected within a wide range to respect the local needs of each country.
- Synchronization input: this is used to synchronize the clock inside Ekip with that of the meter. It can also be used to signal a change in band.

Parameters of the user:

- Type of user: can be selected from among load and generator.
- Minimum disconnection time (T off min): this is the minimum time for which a load or generator is not supplied with power following disconnection. This is useful when you wish to avoid frequent operations on users that are at the top of the priority list. Ekip Power Controller reconnects the load or generator only after the time set has passed.
- Maximum disconnection time (T off max): this is the maximum time for which no power is permitted. It is required, for example, in the case of an oven to keep the temperature within the established limits. When the time has passed, Ekip Power Controller reactivates it automatically, disconnecting, if necessary, a load of a higher priority.
- Minimum connection time (T on min): minimum time for which a load or generator is kept powered following reconnection. It is useful in the event the generator has a minimum time for which it must remain connected. Until the time set has passed, Ekip Power Controller will not disconnect the load, connecting, if necessary, loads of a higher priority.
- Time window: this is the hours in the day when a load or generator can be operated. It is useful, for example, in the case of a cafeteria that cannot be disconnected during meal times, or a diesel generator that can not be operated at night due to noise pollution.
- Temporary unavailability: a user can be temporarily deactivated, for example, because it is undergoing maintenance, through the circuit breaker display or digital input connected to a manual/automatic selector. The digital input can also be used, for example, in the case of a fridge, to manage its interruptability: with active input the fridge cannot be disconnected as it is above the minimum temperature, with inactive input, on the other hand, it can be disconnected.

Power limit	can be set directly in kW
Time bands	up to 4
Synchronization with contactor	•
Evaluation time	5...120 min
Number of loads/generators	up to 15
Priority	from 1 to 15
t on min	1...360 min
t off min	1...360 min
t off max	1...360 min
Temporary disabling input	1 for each device
Controllable devices	load/generator
Type of control	- molded case or power circuit breaker - modular circuit breakers - contactors - control circuit of load/generator
Type of connections	- wired - with Ekip Link communication for ACB

Technical characteristics for protection units

Protection functions

3

ABB Code	ANSI/IEEE C37.2 Code	Function	Threshold
L	49	Overload protection	I1 = 0.4 - 0.42 - 0.45 - 0.47 - 0.5 - 0.52 - 0.55 - 0.57 - 0.6 - 0.62 - 0.65 - 0.67 - 0.7 - 0.72 - 0.75 - 0.77 - 0.8 - 0.82 - 0.85 - 0.87 - 0.9 - 0.92 - 0.95 - 0.97 - 1 x In
		Thermal memory	
		Tolerance	tripping between 1.05 and 1.2 x I1
S	51	Short-circuit selective protection	I2 = 0.6 - 0.8 - 1 - 1.5 - 2 - 2.5 - 3 - 3.5 - 4 - 5 - 6 - 7 - 8 - 9 - 10 x In
		Tolerance	± 7% If ≤ 6 x In ± 10% If > 6 x In
		Short-circuit selective protection	I2 = 0.6 - 0.8 - 1 - 1.5 - 2 - 2.5 - 3 - 3.5 - 4 - 5 - 6 - 7 - 8 - 9 - 10 x In
		Thermal memory	
		Tolerance	± 7% If ≤ 6 x In ± 10% If > 6 x In
I	50	Short-circuit instantaneous protection	I3 = 1.5 - 2 - 3 - 4 - 5 - 6 - 7 - 8 - 9 - 10 - 11 - 12 - 13 - 14 - 15 x In
		Tolerance	± 10%
G	51N	Ground fault protection	I4 ⁽¹⁾ = 0.1 - 0.2 - 0.3 - 0.4 - 0.6 - 0.8 - 1 x In ⁽³⁾
		Tolerance	± 7%
		Ground fault protection	I4 ⁽¹⁾ = 0.1 - 0.2 - 0.3 - 0.4 - 0.6 - 0.8 - 1 x In ⁽³⁾
		Tolerance	± 7%

(1) G protection below 100A or below 0.2 In available with auxiliary supply

(2) The minimum trip time is 1s, regardless of the type of curve set (self-protection)

(3) The maximum value for G protection is 1200A

The tolerances above apply to trip units already powered by the main circuit with current flowing in at least two-phases or an auxiliary power supply. In all other cases the following tolerance values apply

ABB Code	Trip threshold	Trip time
L	Trip between 1.05 and 1.2 x I1	± 20%
S	± 10%	± 20%
I	± 15%	≤ 60ms
G	± 15%	± 20%



Trip time	Excludibility	Pre Alarm	Trip curve	Ekip Dip
with I = 3 I _n , t ₁ = 3 - 12 - 24 - 36 - 48 - 72 - 108 - 144 s ⁽²⁾	No	50 ... 90 I _n Step 1%	t = k / I ²	●
	Yes			●
± 10% I _f ≤ 6 x I _n ± 20% I _f > 6 x I _n				
t ₂ = 0.1 - 0.2 - 0.3 - 0.4s	Yes	No	t = k	●
The better of the two data: ± 10% or ± 40 ms				
with I = 10 I _n , t ₂ = 0.1 - 0.2 - 0.3 - 0.4s	Yes	No	t = k / I ²	●
	Yes	No		
± 15% I _f ≤ 6 x I _n ± 20% I _f > 6 x I _n				
Instantaneous	Yes	No	t = k	●
≤ 30 ms				
t ₄ = 0.1 - 0.2 - 0.4 - 0.8s	Yes	No	t = k	●
The better of the two data: ± 10% or ± 40 ms				
t ₄ = 0.1 - 0.2 - 0.4 - 0.8s	Yes	No	t = k / I ²	●
± 15%				

Technical characteristics for protection trip units

Protection functions

3

ABB Code	ANSI Code	Function	Threshold	Threshold step	Tripping time	Time Step
L	49	Overload Protection	$I1 = 0.4 \dots 1 \times I_n$	$0.001 \times I_n$	with $I = 3 I1$, $t1 = 3 \dots 144 \text{ s}$	1s
		Thermal Memory				
	49	Tolerance	tripping between 1.05 and $1.2 \times I1$		$\pm 10\% I \leq 6 \times I_n$ $\pm 20\% I > 6 \times I_n$	
		Overload Protection	$I1 = 0.4 \dots 1 \times I_n$	$0.001 \times I_n$	with $I = 3 I1$, $t1 = 3 \dots 144 \text{ s}$ Standard inverse SI: $k=0.14 \alpha=0,02$ Very Inverse VI: $k=13.5 \alpha=1$ Extremely Inverse EI: $k=80 \alpha=2$ $t=k/14$: $k=80 \alpha=4$	1s
	Tolerance	tripping between 1.05 and $1.2 \times I1$		$\pm 10\% I \leq 6 \times I_n$ $\pm 20\% I > 6 \times I_n$		
S	50TD	Time-delayed overcurrent protection	$I2 = 0.6 \dots 10 \times I_n$	$0.1 \times I_n$	$t2 = 0.05 \dots 0.4 \text{ s}$	0.01s
	68	Zone selectivity			$t2\text{sel} = 0.04 \dots 0.2 \text{ s}$	0.01s
		Start up	Activation: $0.6 \dots 10 \times I_n$	$0.1 \times I_n$	Range: $0.1 \dots 30 \text{ s}$	0.01s
		Tolerance	$\pm 7\% I \leq 6 \times I_n$ $\pm 10\% I > 6 \times I_n$		The better of the two data: $\pm 10\% \text{ or } \pm 40 \text{ ms}$	
	51	Time-delayed overcurrent protection	$I2 = 0.6 \dots 10 \times I_n$	$0.1 \times I_n$	with $I = 10 I_n$, $t2 = 0.05 \dots 0.4 \text{ s}$	0.01s
	Thermal Memory					
	Tolerance	$\pm 7\% I \leq 6 \times I_n$ $\pm 10\% I > 6 \times I_n$		$\pm 15\% I \leq 6 \times I_n$ $\pm 20\% I > 6 \times I_n$		
S2	50TD	Time-delayed overcurrent protection	$I5 = 0.6 \dots 10 \times I_n$	$0.1 \times I_n$	$t5 = 0.05 \dots 0.4 \text{ s}$	0.01s
		Start up	Activation: $0.6 \dots 10 \times I_n$	$0.1 \times I_n$	Range: $0.1 \dots 30 \text{ s}$	0.01s
		Tolerance	$\pm 7\% I \leq 6 \times I_n$ $\pm 10\% I > 6 \times I_n$		The better of the two data: $\pm 10\% \text{ or } \pm 40 \text{ ms}$	
S(V)	51V	Voltage controlled overcurrent protection	$I20 = 0.6 \dots 10 \times I_n$	$0.1 \times I_n$	$t20 = 0.05 \dots 30 \text{ s}$	0.01s
		Step mode (controlled mode)	$UI = 0.2 \dots 1 \times U_n$	$0.01 \times U_n$		
			$Ks = 0.1 \dots 1$	0.01		
		Linear mode (restrained mode)	$UI = 0.2 \dots 1 \times U_n$	$0.01 \times U_n$		
			$Uh = 0.2 \dots 1 \times U_n$	$0.01 \times U_n$		
			$Ks = 0.1 \dots 1$	0.01		
	Tolerance	$\pm 10\%$		The better of the two data: $\pm 10\% \text{ or } \pm 40 \text{ ms}$		
S2(V)	51V	Voltage controlled overcurrent protection	$I21 = 0.6 \dots 10 \times I_n$	$0.1 \times I_n$	$t21 = 0.05 \dots 30 \text{ s}$	0.01s
		Step mode (controlled mode)	$UI2 = 0.2 \dots 1 \times U_n$	$0.01 \times U_n$		
			$Ks2 = 0.1 \dots 1$	0.01		
		Linear mode (restrained mode)	$UI2 = 0.2 \dots 1 \times U_n$	$0.01 \times U_n$		
			$Uh2 = 0.2 \dots 1 \times U_n$	$0.01 \times U_n$		
			$Ks2 = 0.1 \dots 1$	0.01		
	Tolerance	$\pm 10\%$		The better of the two data: $\pm 10\% \text{ or } \pm 40 \text{ ms}$		
I	50	Istantaneous overcurrent protection	$I3 = 1.5 \dots 15 \times I_n$	$0.1 \times I_n$	Instantaneous	-
		Start up	Activation: $1.5 \dots 15 \times I_n$	$0.1 \times I_n$	Range: $0.1 \dots 30 \text{ s}$	0.01s
		Tolerance	$\pm 10\%$		$\leq 30 \text{ ms}$	
2I	50	Istantaneous overcurrent protection	$I31 = 1.5 \dots 15 \times I_n$	$0.1 \times I_n$	Instantaneous	-
		Tolerance	$\pm 10\%$		$\leq 30 \text{ ms}$	
MCR		Closing on short-circuit protection	$I3 = 1.5 \dots 15 \times I_n$	$0.1 \times I_n$	Instantaneous Activation range: $40 \dots 500 \text{ ms}$	0.01s
		Tolerance	$\pm 10\%$		$\leq 30 \text{ ms}$	

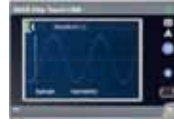

Excludibility	Excludibility trip	Pre-allarm	Trip curve	Ekip Touch	Ekip Hi-Touch	Ekip G Touch	Ekip G Hi-Touch
yes, with rating plug L=off yes	no	50...90% I1	$t = k / I^2$	●	●	●	●
yes, with rating plug L=off yes	no	50...90% I1	$t = \frac{k t1}{\left(\frac{I}{I1}\right)^\alpha - 1}$	●	●	●	●
yes yes yes	yes	no	$t = k$	●	●	●	●
yes yes	yes	no	$t = k / I^2$	●	●	●	●
yes yes	yes	no	$t = k$		●		●
yes	yes	no	$t = k$			●	●
yes	yes	no	$t = k$				●
yes yes	no	no	$t = k$	●	●	●	●
yes	no	no	$t = k$	●	●	●	●
yes	no	no	$t = k$	●	●	●	●

Table continued on next page

Technical characteristics for protection trip units

Protection functions

3

ABB Code	ANSI Code	Function	Threshold	Threshold step	Tripping time	Time Step
G	50N/50N TD	Ground fault protection	$I_4^{(1)} = I_{nst}, 0.1...1 \times I_n^{(2)}$	$0.001 \times I_n$	with $I > I_4, t_4 = 0.1...1s$	0.05s
		Zone selectivity			$t_{4sel} = 0.04...0.2s$	0.01s
	68	Start up	Activation: $0.2...10 \times I_n$	$0.2 \times I_n$	range: $0.1...30s$	0.01s
		Tolerance	$\pm 7\%$		The better of the two data: $\pm 10\%$ or $\pm 40 ms$	
	51N	Ground fault protection	$I_4^{(1)} = 0.1...1 \times I_n^{(2)}$	$0.01 \times I_n$	with $I = 4 I_n, t_4 = 0.1...1s$	0.05s
		Tolerance	$\pm 7\%$		$\pm 15\%$	
Gext	50G TD	Ground fault protection	$I_4^{(1)} = 0.1...1 \times I_n \text{ Toroid}^{(2)}$	$0.001 \times I_n \text{ Toroid}$	$t_4 = 0.1...1s$	0.05s
		Start up	Activation: $0.1...1 \times I_n$	$0.02 \times I_n$	range: $0.1...30s$	0.01s
		Tolerance	$\pm 7\%$		The better of the two data: $\pm 10\%$ or $\pm 40 ms$	
	51G	Ground fault protection	$I_4^{(1)} = 0.1...1 \times I_n^{(2)}$	$0.001 \times I_n$	with $I = 4 I_n, t_4 = 0.1...1s$	0.01s
		Tolerance	$\pm 7\%$		$\pm 15\%$	
	D	67	Directional overcurrent protection	$I_7 = 0.6...10 \times I_n$	$0.1 \times I_n$	$t_7 = 0.2...0.8s$
68		Zone selectivity			$t_{7sel} = 0.13...0.5s$	0.01s
		Start up	Activation: $0.6...10 \times I_n$	$0.1 \times I_n$	range: $0.1...0.8s$	0.01s
		Tolerance	$\pm 7\%$ $I_7 \leq 6 \times I_n$ $\pm 10\%$ $I_7 > 6 \times I_n$		The better of the two data: $\pm 10\%$ or $\pm 40 ms$	
IU	46	Current imbalance protection	$I_6 = 2...90\% I_n \text{ imbalance}$	$1\% I_n$	$t_6 = 0.5...60s$	0.5s
		Tolerance	$\pm 10\%$		The better of the two data: $\pm 10\%$ or $\pm 40 ms$	
Rc	64 50N TD 87N	Residual current protection Differential ground fault protection	$I_{\Delta n} = 3 - 5 - 7 - 10 - 20 - 30A$		$t_{\Delta n} = 0.06 - 0.1 - 0.2 - 0.3 - 0.4 - 0.5 - 0.8s$	
		Tolerance	$-20\% \div 0\%$		0.06s	
UV	27	Undervoltage Protection	$U_8 = 0.5...0.98 \times U_n$	$0.001 \times U_n$	$t_8 = 0.05...120s$	0.05s
		Tolerance	$\pm 5\%$		The better of the two data: $\pm 10\%$ or $\pm 40 ms$	
UV2	27	Undervoltage Protection	$U_{15} = 0.5...0.98 \times U_n$	$0.001 \times U_n$	$t_{15} = 0.05...120s$	0.05s
		Tolerance	$\pm 5\%$		The better of the two data: $\pm 10\%$ or $\pm 40 ms$	
OV	59	Overvoltage protection	$U_9 = 1.02...1.5 \times U_n$	$0.001 \times U_n$	$t_9 = 0.05...120s$	0.05s
		Tolerance	$\pm 5\%$		The better of the two data: $\pm 10\%$ or $\pm 40 ms$	
OV2	59	Overvoltage protection	$U_{16} = 1.02...1.5 \times U_n$	$0.001 \times U_n$	$t_{16} = 0.05...120s$	0.05s
		Tolerance	$\pm 5\%$		The better of the two data: $\pm 10\%$ or $\pm 40 ms$	
RV	59N	Residual overvoltage protection	$U_{22} = 0.1...0.5 \times U_n$	$0.001 \times U_n$	$t_{22} = 0.5...120s$	0.05s
		Tolerance	$\pm 5\%$		The better of the two data: $\pm 10\%$ or $\pm 40 ms$	
VU	47	Voltage imbalance protection	$U_{14} = 2...90\% U_n \text{ imbalance}$	$1\% U_n$	$t_{14} = 0.5...60s$	0.5s
		Tolerance	$\pm 10\%$		The better of the two data: $\pm 10\%$ or $\pm 40 ms$	
UF	81L	Underfrequency protection	$f_{12} = 0.9...0.99 \times f_n$	$0.01 \times f_n$	$t_{12} = 0.2...120s$	0.1s
		Tolerance	$\pm 5\%$		The better of the two data: $\pm 10\%$ or $\pm 40 ms$, min = 30 ms	
UF2	81L	Underfrequency protection	$f_{17} = 0.9...0.99 \times f_n$	$0.01 \times f_n$	$t_{17} = 0.2...120s$	0.1s
		Tolerance	$\pm 5\%$		The better of the two data: $\pm 10\%$ or $\pm 40 ms$, min = 30 ms	
OF	81H	Overfrequency protection	$f_{13} = 1.01...1.1 \times f_n$	$0.01 \times f_n$	$t_{18} = 0.2...120s$	0.1s
		Tolerance	$\pm 5\%$		The better of the two data: $\pm 10\%$ or $\pm 40 ms$	



Excludibility	Excludibility trip	Pre-allarm	Trip curve	Ekip Touch	Ekip Hi-Touch	Ekip G Touch	Ekip G Hi-Touch
yes	yes	90% I4	t = k	●	●	●	●
yes				●	●	●	●
yes				●	●	●	●
yes	yes	90% I4	t = k / I ²	●	●	●	●
yes	yes	90% I4	t = k	●	●	●	●
yes				●	●	●	●
yes	yes	90% I4	t = k / I ²	●	●	●	●
yes	yes	no	t = k		●		●
yes					●		●
yes					●		●
yes	yes	no	t = k	●	●	●	●
Attivabile with rating plug Rc	no	no	t = k	●	●	●	●
yes	yes	no	t = k	○	●	●	●
yes	yes	no	t = k		●		●
yes	yes	no	t = k	○	●	●	●
yes	yes	no	t = k		●		●
yes	yes	no	t = k			●	●
yes	yes	no	t = k	○	●	●	●
yes	yes	no	t = k	○	●	●	●
yes	yes	no	t = k		●		●
yes	yes	no	t = k	○	●	●	●

Table continued on next page

Technical characteristics for protection trip units

Protection functions

3

ABB Code	ANSI Code	Function	Threshold	Threshold step	Tripping time	Time Step
OF2	81H	Overfrequency protection	$f18 = 1.01 \dots 1.1 \times f_n$	$0.01 \times f_n$	$t18 = 0.2 \dots 120s$	0.1s
		Tolerance	$\pm 5\%$		The better of the two data: $\pm 10\%$ or $\pm 40ms$	
ROCOF	81R	Rate of change of frequency protection	$f28 = 0.4 \dots 10 \text{ Hz/s}$	0.2 Hz/s	with $f > f28$ $t28 = 0.5 \dots 10s$	0.1s
		Tolerance	$\pm 10\%$		The better of the two data: $\pm 20\%$ or $\pm 200ms$	
RP	32R	Reverse active power protection	$P11 = -1 \dots -0.05 S_n$	$0.001 S_n$	$t11 = 0.5 \dots 100s$	0.1s
		Tolerance	$\pm 10\%$		The better of the two data: $\pm 10\%$ or $\pm 40ms$	
RQ	40/32R	Loss of field or reverse reactive power protection	$Q24 = -1 \dots -0.1 S_n$ $Kq = -2 \dots 2$	$0.001 S_n$ 0.01	$t24 = 0.5 \dots 100s$	0.1s
		Loss of field or reverse reactive power protection	$Q25 = -1 \dots -0.1 S_n$ $Kq2 = -2 \dots 2$	$0.001 S_n$ 0.01	$t24 = 0.5 \dots 100s$	
		Tolerance	$\pm 10\%$		The better of the two data: $\pm 10\%$ or $\pm 40ms$	
OP	320F	Active overpower protection	$P26 = 0.4 \dots 2 S_n$	$0.001 S_n$	$t26 = 0.5 \dots 100s$	0.5s
		Tolerance	$\pm 10\%$		The better of the two data: $\pm 10\%$ or $\pm 40ms$	
OQ	320F	Reactive overpower protection	$Q27 = 0.4 \dots 2 S_n$	$0.001 S_n$	$t27 = 0.5 \dots 100s$	0.5s
		Tolerance	$\pm 10\%$		The better of the two data: $\pm 10\%$ or $\pm 40ms$	
UP	32LF	Active underpower protection	$P23 = 0.1 \dots 1 \times S_n$	$0.001 \times S_n$	$t23 = 0.5 \dots 100s$	0.5s
		Temporary deactivation			range from closing: $0.1 \dots 30s$ o with digital input	
		Tolerance	$\pm 10\%$		The better of the two data: $\pm 10\%$ or $\pm 40ms$	
Synchrocheck SC	25	Synchrocheck (Live busbars)	$U_{live} = 0.5 \dots 1.1 U_n$ $\Delta U = 0.02 \dots 0.12 U_n$ $\Delta f = 0.1 \dots 1 \text{ Hz}$ $\Delta \Phi = 5 \dots 50^\circ \text{ elt}$	$0.001 U_n$ $0.001 U_n$ 0.1 Hz 5° elt	$t_{ref} = 0.1 \dots 30s$ Time settings stability voltage time for live state = $0.1 \dots 30s$ Minimum matching Time = $0.1 \dots 3s$	0.1s
		Tolerance	$\pm 10\%$			
	47	Synchrocheck (Live, Dead busbars)	$U_{live} = 0.5 \dots 1.1 U_n$ $U_{dead} = 0.02 \dots 0.2 U_n$	$0.01 U_n$ $0.01 U_n$	$t_{ref} = 0.1 \dots 30s$	0.1s
		Tolerance	$\pm 10\%$			
	78	Cyclical direction of the phases	$1-2-3$ or $3-2-1$			
		3phase Power factor	$PF3 = 0.2 \dots 0.95$	0.01		
Current threshold		$LC1 = 50\% \dots 100\% I1$ $LC2 = 50\% \dots 100\% I1$ $I_w = 0.3 \dots 10 I_n$	1% 1% $0.01 \times I_n$			
	Tolerance	$\pm 10\%$				

1) G protection below 100A or $0.2 \times I_n$ available with auxiliary supply.

2) The maximum value for G protection is 1200A.

The tolerances above apply to trip units already powered by the main circuit with current flowing in at least two-phases or an auxiliary power supply.

In all other cases the following tolerance values apply:

ABB Code	Trip threshold	Trip time
L	Trip between 1.05 and $1.2 \times I1$	$\pm 20\%$
S	$\pm 10\%$	$\pm 20\%$
I	$\pm 15\%$	$\leq 60ms$
G	$\pm 15\%$	$\pm 20\%$
Other protection	$\pm 15\%$	$\pm 20\%$



Excludibility	Excludibility trip	Pre-allarm	Trip curve	Ekip Touch	Ekip Hi-Touch	Ekip G Touch	Ekip G Hi-Touch
yes	yes	no	t = k		●		●
yes	yes	no	t = k				●
yes	yes	no	t = k	●	●	●	●
yes	yes	no	t = k			●	●
yes	yes	no	t = k				●
yes	yes	no	t = k			●	●
yes	yes	no	t = k			●	●
yes	yes	no	t = k			●	●
yes	only signalling	no	-	○ ○○	○○	○○	○○
yes	only signalling	no	-				
yes	only signalling	no	-	○	●	●	●
yes	only signalling	no	-	○	●	●	●
yes	only signalling	no	-	●	●	●	●

Key:

- not available
- available
- available with Ekip Measuring and Ekip Measuring Pro
- available with Ekip Synchrocheck

Technical characteristics for protection trip units

Measurement functions

3

Instantaneous measurements		Displayed with Ekip Multimeter	Parameters
Currents (RMS)	[A]	•	L1, L2, L3, Ne
Ground fault current (RMS)	[A]	•	I _g
Record of values: of the parameter for each interval with time-stamping			Parameters
Current: minimum and maximum	[A]	•	I Min, I Max
Information on trip and opening data: after a fault with or without auxiliary supply			Parameters
Type of protection tripped		•	eg. L, S, I, G
Fault values per phase	[A]	•	eg. I1, I2, I3, neutral for S protection
Time-stamping		•	Date, time and progressive number
Maintenance indicators			Parameters
Information on last 30 trips		•	Type of protection, fault values and time-stamping
Information on last 200 events		•	Type of event, time-stamping
Number of mechanical operations ⁽¹⁾	[no]	•	Can be associated to alarm
Total number of trips	[no]	•	
Total operating time	[h]	•	
Wear of contacts	[%]	•	Prealarm >80%, Alarm = 100%
Date of maintenance operations performed		•	Last
Indication of maintenance operation needed		•	
Circuit-breaker I.D.		•	Type of circuit-breaker, assigned device name, serial number
Self-diagnosis			Parameters
Check of continuity of internal connections		•	Alarm due to disconnection: rating plug, sensors, trip coil
Failure of circuit-breaker to open (ANSI 50BF)		•	Alarm following non-tripping of protection functions
Temperature (T)		•	Pre-alarm and alarm for abnormal temperature

⁽¹⁾ with auxiliary supply present



Precision	Standard di riferimento	Ekip Dip
1%	Class 1 IEC 61557-12	●
2%		●
Window	Intervals	
Fixed, synchronizable by remote	Duration: 5...120min Number of intervals: 24	●
		●
		●
		●
		●
		●
		●
		●
		●
		●
		●
		●
		●
Note: Opening of the circuit-breaker can be set in the event of alarm		●
		●
		●

Technical characteristics for protection trip units

Measurement functions

3

Instantaneous measurements		Parameters
Currents (RMS)	[A]	L1, L2, L3, Ne
Ground fault current (RMS)	[A]	Ig
Phase-phase voltage (RMS)	[V]	U12, U23, U31
Phase-neutral voltage (RMS)	[V]	U1, U2, U3
Phase sequence		
Frequency	[Hz]	f
Active power	[kW]	P1, P2, P3, Ptot
Reactive power	[kVAR]	Q1, Q2, Q3, Qtot
Apparent power	[KVA]	S1, S2, S3, Stot
Power factor		PF1, PF2, PF3, PF total
Peak factor		total
Counters recorded from installation or from the last reset		Parameters
Active energy	[kWh]	Ep total, Ep positive, Ep negative
Reactive energy	[kVARh]	Eq total, Ep positive, Ep negative
Apparent energy	[KVAh]	Es total
Network Analyzer		Parameters
Hourly average voltage value	[V] [no]	- Umin= 0.75...0.95 x Un - Umax= 1.05...1.25 x Un - Events counter (nr. of events day by day in the last year plus the total events in the breaker's lifetime)
Short voltage interruptions	[no]	- Umin= 0.75...0.95 x Un - Events counter (nr. of events day by day in the last year plus the total events in the breaker's lifetime)
Short voltage spikes	[no]	- Umax= 1,05...1,25 x Un - Events counter (nr. of events day by day in the last year plus the total events in the breaker's lifetime)
Slow voltage sags and swells	[no]	- Umin1= 0.75...0.95 x Un - Umin2= 0.75...0.95 x Un - Umin3= 0.75...0.95 x Un - Umax1= 1.05...1.25 x Un - Umax2= 1.05...1.25 x Un - Events counter (nr. of events day by day in the last year plus the total events in the breaker's lifetime)
Voltage imbalance	[V] [no]	- U neg. seq.= 0.02...0.10 x Un - Events counter (nr. of events day by day in the last year plus the total events in the breaker's lifetime)
Harmonic analysis		Current and Voltage - up to 50° - Alarm THD: 5...20% - Single harmonic alarm: 3...10% plus a count of minutes the harmonic has been exceeded



	Ekip Touch	Ekip Hi-Touch	Ekip G Touch	Ekip G Hi-Touch
Precision				
1%	●	●	●	●
2%	●	●	●	●
0.5%	○	●	●	●
0.5%	○	●	●	●
	○	●	●	●
0.2%	○	●	●	●
2%	○	●	●	●
2%	○	●	●	●
2%	○	●	●	●
2%	○	●	●	●
2%	○	●	●	●
Precision				
2%	○	●	●	●
2%	○	●	●	●
2%	○	●	●	●
Intervals				
t = 5...120min	-	●	-	●
t <40ms	-	●	-	●
t <40ms	-	●	-	●
t = 0.02s...60s	-	●	-	●
t = 5...120min	-	●	-	●
	-	●	-	●

Technical characteristics for protection trip units

Measurement functions

3

Record of values: of the parameter for each interval with time-stamping		Parameters
Current: minimum and maximum	[A]	I Min, I Max
Phase-phase voltage: minimum and maximum	[V]	U Min, U max
Active power: average and maximum	[kW]	P Mean, P Max
Reactive power: average and maximum	[kVAR]	Q Mean, Q Max
Apparent power: average and maximum	[KVA]	S Mean, S Max
Data logger: record of high sampling rate parameters		Parameters
Currents	[A]	L1, L2, L3, Ne, Ig
Voltages	[V]	U12, U23, U31
Sampling rate	[Hz]	1200-9600
Maximum recording duration	[s]	18
Recording stop delay	[s]	0-10s
Number of registers	[no]	2 independent
Information on trip and opening data: after a fault without auxiliary supply		Parameters
Type of protection tripped		eg. L, S, I, G, UV, OV
Fault values per phase	[A/V/Hz w/VAR]	eg. I1, I2, I3, neutral for S protection V12, V23, V32 for UV protection
Time-stamping		Date, time and progressive number
Maintenance indicators		Parameters
Information on last 30 trips		Type of protection, fault values and time-stamping
Information on last 200 events		Type of event, time-stamping
Number of mechanical operations ⁽¹⁾	[no]	Can be associated to alarm
Total number of trips	[no]	
Total operating time	[h]	
Wear of contacts	[%]	Prealarm >80% Alarm = 100%
Date of maintenance operations performed		Last
Indication of maintenance operation needed		
Circuit-breaker I.D.		Type of circuit-breaker, assigned device name, serial number
Self-diagnosis		Parameters
Check of continuity of internal connections		Alarm due to disconnection: rating plug, sensors, trip coil
Failure of circuit-breaker to open (ANSI 50BF)		Alarm following non-tripping of protection functions
Temperature (OT)		Prealarm and alarm for abnormal temperature

(1) with auxiliary supply present

Communication devices and systems

Introduction 4/2

Supervision and control

Supervision of the switchgear compartment	4/4
Switchgear supervision	4/6
Supervision of the electrical installation	4/8

Software

Ekip Connect	4/10
Ekip View	4/12
Ekip T&P Interface	4/14

Communication devices and systems





Introduction

SACE Emax 2 circuit breakers provide a complete and flexible offering that can be adapted to the actual level of supervision and control required.

The rising need of systems that provide supervision and control for low voltage electrical distribution plants is being driven by the growing need to:





- optimize energy efficiency by analyzing energy consumption;
- ensure service continuity, minimizing the time needed to identify and rectify faults;
- guarantee efficient planning of maintenance activities.

4

Typical sector	Industrial	Hospital	OEMs	Naval
				
Level of supervision and control in low voltage systems	Switchgear compartment			
Solution with SACE Emax 2	<ul style="list-style-type: none"> - Ekip Touch trip units with high resolution display 		<ul style="list-style-type: none"> - Ekip trip units - Ekip Multimeter display on the front of switchgear 	
Benefit of the ABB solution	<ul style="list-style-type: none"> - simple and intuitive use - does not require an auxiliary power supply for safety 		<ul style="list-style-type: none"> - reduced dimensions - flexible installation - simultaneous reading of various electrical values 	

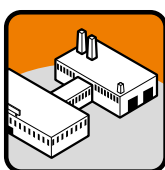
According to their complexity, the supervision of low voltage systems may involve different levels:

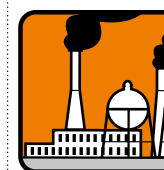
- **switchgear compartment:** for control of the main electrical values of the circuit breaker. It provides a general but precise indication of the level of absorption of the system (main circuit breaker) and the individual utilities (outgoing feeder circuit breakers).
- **electrical switchgear:** to display the data of all circuit breakers installed in the switchgear from a single point: in local mode via the operator panel on the front of the switchgear, or remotely via an Internet connection.
- **electrical system:** to manage complex systems in which devices must be integrated with automated industrial processes or in intelligent electrical networks, better known as smart grids.

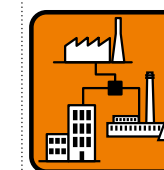
Industries of medium dimensions	Shopping centres	Office buildings	Oil & gas	Automated industrial processes	Data centers	Smart grids
						

Electrical switchgear	Electrical installation
<ul style="list-style-type: none"> - Ekip trip units - Ekip Link module - Ekip Control Panel operator panel with color touch screen - Standardized EtherNet components 	<ul style="list-style-type: none"> - Ekip Touch trip units - Ekip Com communication modules - Ekip View supervision software
<ul style="list-style-type: none"> - centralized control from front of the switchgear - access to the installation via the web - rapid installation - ease of use - ready to use system 	<ul style="list-style-type: none"> - wide range of protocols supported - installation times reduced to a minimum - redundancy of communication - ready to smart grid circuit breakers - complete network supervision

Communication devices and systems

Supervision of the switchgear compartment

The SACE Emax 2 circuit breakers equipped with Ekip electronic trip units enable electrical measurements and diagnostic data to be displayed on the front of the switchgear.

Solution with Ekip Touch trip units

The Ekip Touch electronic trip units are the ideal solution for supervision and control of the compartments in switchgear. In particular:

- their use is simple and intuitive thanks to a large, high resolution, color touch screen;
- they do not require an auxiliary power supply for safety; the Ekip Touch trip units are directly supplied by the current sensors integrated in the circuit breaker, thereby avoiding the use of external power supplies.

4

Ekip Touch



Ekip Multimeter

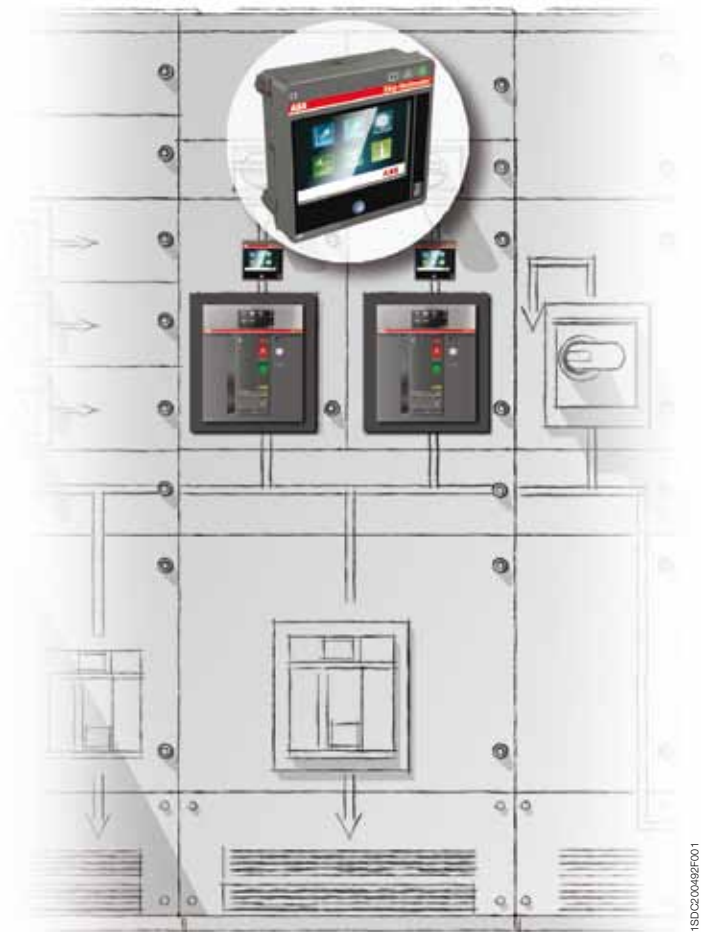

For the list of information available for each trip unit, consult chapter 3.

Solution with Ekip Multimeter Display on the front of the switchgear

The Ekip Multimeter is a display unit to be installed on the front of the switchgear for SACE Emax 2 power circuit breakers equipped with Ekip electronic trip units.

This device remotely displays the information about the system that is available in the trip unit to which it is connected.

The main characteristics of the Ekip Multimeter unit are:

- **Graphical and functional uniformity with the Ekip Touch trip units;** Ekip Multimeter uses the same display as the trip unit to which it is connected, ensuring perfect continuity between the graphic display and the menu items.
- **Reduced dimensions;** the Ekip Multimeter guarantees the precision of the trip unit to which it is connected and performs the function of a measuring instrument without requiring the installation of external current and voltage transformers.
- **Flexible installation;** the Ekip Multimeter can be installed up to 49 feet (15 meters) from the trip unit, enabling access to information from the most convenient point.
- **Simultaneous reading of the various electrical values;** the advanced connection system used allows several Ekip Multimeter devices to be connected to the same protection trip unit.

Furthermore, if connected to trip units equipped with a display, the Ekip Multimeter enables adjustment of the parameters and protection thresholds.

Electronic trip unit	Supervision of switchgear compartment			
	Ekip Dip	Ekip Touch	Ekip Touch + Ekip measuring module Ekip G Touch	Ekip Hi Touch Ekip G Hi-Touch
Solution	Ekip trip units + Ekip Multimeter			
Type of trip units connectable to Ekip Multimeter	Ekip trip units			
Number of trip units connectable to Ekip Multimeter	1			
Measurement functions				
Currents	•	•	•	•
Voltages	-	-	•	•
Powers	-	-	•	•
Energies	-	-	•	•
Harmonics	-	-	-	•
Network Analyzer	-	-	-	•
Adjustment functions				
Setting of thresholds	-	•	•	•
Setting of thresholds, second set	-	-	-	•
Resetting of alarms	•	•	•	•
Diagnostics				
Protection function alarms	•	•	•	•
Device alarms	•	•	•	•
Protection unit tripping details	•	•	•	•
Events log	•	•	•	•
Protection unit tripping log	•	•	•	•
Maintenance				
Number of operations	•	•	•	•
Number of trips	•	•	•	•
Contact wear (endurance)	•	•	•	•
Other data				
Status of circuit breaker	•	•	•	•
Circuit breaker position ¹⁾	•	•	•	•
Local/remote mode	•	•	•	•

1) Circuit breakers equipped with auxiliary contacts to indicate position

Communication devices and systems

Switchgear supervision

Ekip Link is a flexible and efficient solution for controlling and supervising low voltage electrical switchgear; it is a system that enables SACE Emax 2 circuit breakers to be connected to the Ekip Control Panel operator panel by means of Ekip Link interface modules.

Ekip Link system

The main characteristics of the Ekip Link System are:

- **centralized control;** from the Ekip Control Panel operator panel, all the main values of the installation (electrical measurements, system diagnostics, trends...) can be monitored and controlled.
- **adaptation to real requirements;** when only current needs to be monitored, the economic Ekip Dip trip unit can be connected to Ekip Link without having to use circuit breakers equipped with communication modules.
- **access via the Internet** to the installation by any Internet browser using the web server function performed by the Ekip Control Panel.
- **rapid installation,** through the use of standardized EtherNet components such as STP cables and RJ45 type connectors.
- **ease of use;** due to the Ekip Control Panel operator panel in front of the switchgear with color touch screen, the system mimic panel can be displayed so that the entire installation can be controlled rapidly and intuitively.
- **ready to use;** Ekip Control Panel is supplied with pre-configured software that requires no programming. It is only necessary to start scanning the Ekip Link system from the operator panel and in a few seconds communication with the connected devices is active.

Ekip Link enables supervision of electrical switchboard or switchgear containing up to 30 SACE Emax 2 circuit breakers. Tmax T and Tmax XT series circuit breakers equipped with Modbus RTU communication can also be easily integrated into the Ekip Link system using the multi-serial port fitted on the Ekip Control Panel.



1SDC20048F001

		Switchgear supervision			
Electronic trip unit	Ekip Dip	Ekip Touch	Ekip Touch + Ekip measuring module Ekip G Touch	Ekip Hi-Touch Ekip G Hi-Touch	
Solution	Ekip protection trip units equipped with the Ekip Link module + Ekip Control Panel operator panel + standard EtherNet components				
Type of trip units connectable	Ekip protection trip units				
Number of trip units connectable to the Ekip link system	up to 30 ¹⁾				
Data exchange rate of Ekip link system	100 Mbit/sec				
Supervision and control functions					
Circuit breaker opening and closing ²⁾	•	•	•	•	
Electrical value trends			I,V,P	I,V,P	
Log of electrical value trends			I,V,P	I,V,P	
Dynamic installation mimic panel	•	•	•	•	
Automatic scanning of the Ekip Link system	•	•	•	•	
Centralized synchronizing of time	•	•	•	•	
Web server function	• ³⁾	• ³⁾	• ³⁾	• ³⁾	
Measurement functions					
Currents	•	•	•	•	
Voltages	-	-	•	•	
Powers	-	-	•	•	
Energies	-	-	•	•	
Harmonics	-	-	-	•	
Network Analyzer	-	-	-	•	
Data logger	-	•	•	•	
Adjustment functions					
Setting of thresholds	-	•	•	•	
Resetting of alarms	•	•	•	•	
Diagnostics					
Protection function alarms	•	•	•	•	
Device alarms	•	•	•	•	
Protection unit tripping details	•	•	•	•	
Events log	•	•	•	•	
Protection unit tripping log	•	•	•	•	
Transmission of alarms via SMS	optional	optional	optional	optional	
Transmission of alarms via e-mail	optional	optional	optional	optional	
Maintenance					
Number of operations	•	•	•	•	
Number of trips	•	•	•	•	
Contact wear (endurance)	•	•	•	•	
Other data					
Circuit breaker status	•	•	•	•	
Circuit breaker position ⁴⁾	•	•	•	•	
Local/remote mode	•	•	•	•	

1) Ekip Control Panel is available in two versions that can manage a maximum of 10 or 30 circuit breakers. The number of circuit breakers may vary depending on their type. For details, contact ABB.

2) Circuit breakers equipped with actuation module, electric accessories, opening and closing releases and spring charging motor

3) Two client web accesses included in the licence

4) Circuit breakers equipped with auxiliary contacts to indicate position

Communication devices and systems

Supervision of the electrical installation

The integration of low voltage devices in communication networks is required in particular for: automated industrial processes, industrial and petrochemical sites, modern data centers and intelligent electricity networks, better known as smart grids.

Ekip Com Modules

Thanks to the wide range of communication protocols supported, SACE Emax 2 circuit breakers equipped with Ekip Touch electronic trip units can be directly integrated into communication networks without the need for external interface devices.

4

The distinctive characteristics of the SACE Emax 2 circuit breaker offering for industrial communication are:

- **Wide range of protocols supported;** the Ekip Com communication modules enable integration with the most common communication protocols based on RS485 serial lines and the most modern communication systems based on EtherNet infrastructures, which guarantee an exchange of data in the order of 100 Mbit/s.
- **Reduced installation times;** the plug & play technology of the communication modules enable them to be snapped directly into the terminal box, without needing to remove the electronic trip unit.
- **Repetition of communication for greater reliability of the system;** the circuit breaker can be equipped with two communication modules at the same time, allowing the information on two buses to be exchanged simultaneously.
- **Ready to smart grid;** the Ekip Com 61850 module is the solution for integrating SACE Emax 2 into the automated systems of electrical substations without the need for complex external devices.
- **Complete supervision** of Modbus RTU or Modbus TCP/IP networks via the Ekip View software for PCs.

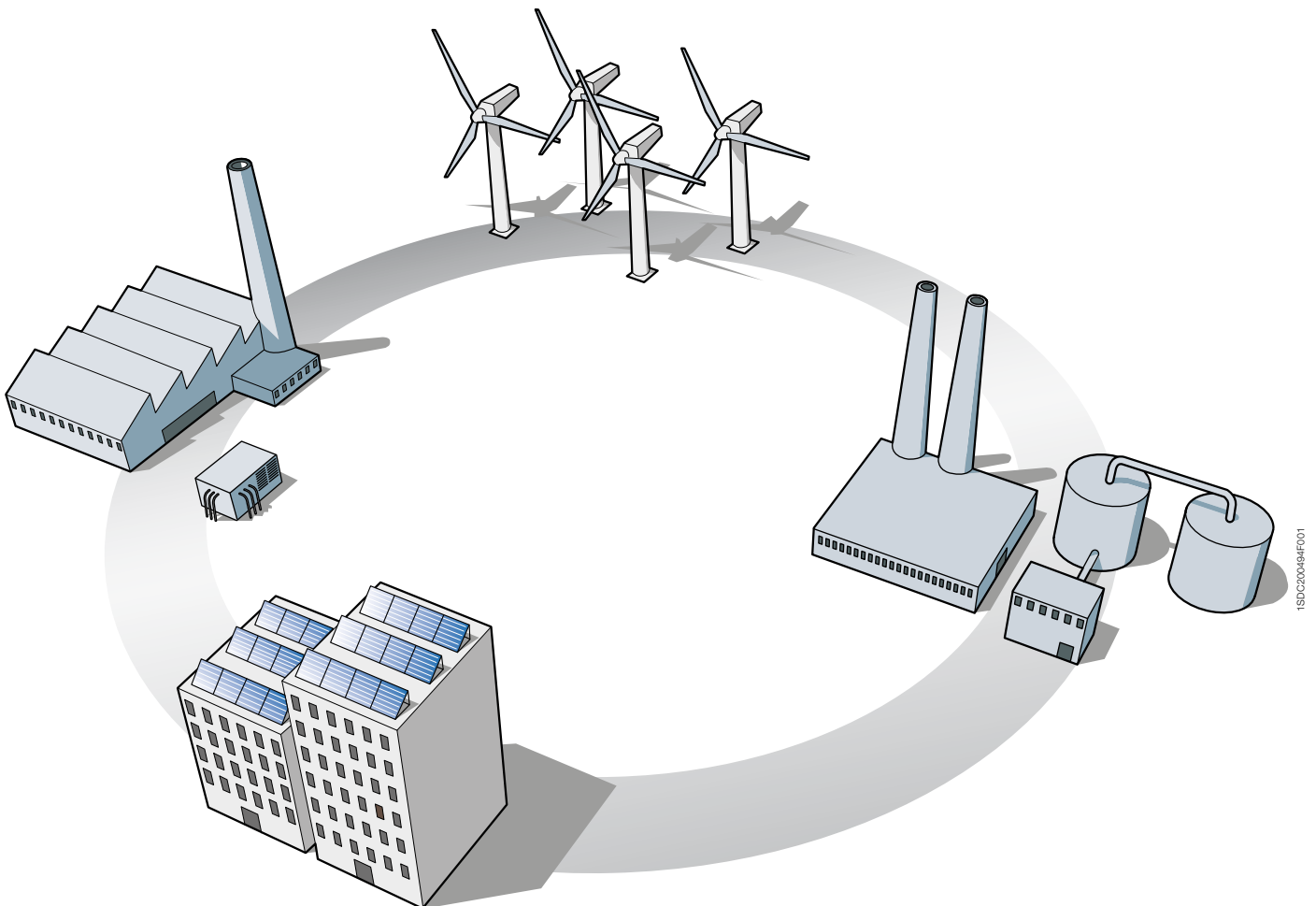

	Supervision of the electrical installation		
Electronic trip unit	Ekip Touch	Ekip Touch + Ekip Measuring module Ekip G Touch	Ekip Hi-Touch Ekip G Hi-Touch
Solution	Ekip Touch trip units + Ekip Com modules		
Protocols supported:			
Modbus RTU	Ekip Com Modbus RS-485		
Profibus-DP	Ekip Com Profibus		
DeviceNet	Ekip Com DeviceNet		
Modbus TCP/IP	Ekip Com Modbus TCP		
Profinet	Ekip Com Profinet		
EtherNet / IP	Ekip Com EtherNet/IP		
IEC61850	Ekip Com IEC61850		
Control functions			
Circuit breakers opening and closing ¹⁾	•	•	•
Measurement functions			
Currents	•	•	•
Voltages	-	•	•
Powers	-	•	•
Energies	-	•	•
Harmonics	-	-	•
Network Analyzer	-	-	•
Data logger	•	•	•
Adjustment functions			
Setting of thresholds	•	•	•
Resetting of alarms	•	•	•
Diagnostic			
Protection function alarms	•	•	•
Device alarms	•	•	•
Protection unit tripping details	•	•	•
Events log	•	•	•
Protection unit tripping log	•	•	•
Maintenance			
Number of operations	•	•	•
Number of trips	•	•	•
Contact wear (endurance)	•	•	•
Other data			
Circuit breaker status	•	•	•
Circuit breaker position ²⁾	•	•	•
Local/remote mode	•	•	•

1) Circuit breakers equipped with Ekip Com Actuator module, electrical accessories, opening and closing releases and spring charging motor
2) Circuit breakers equipped with auxiliary contacts to indicate position

Communication devices and systems

Supervision and control software

ABB offers software applications that allow the Ekip electronic trip units to be utilized to their fullest potential in terms of power management, acquisition and analysis of the electrical values, and testing of the protection, maintenance and diagnostic functions.

Overview of the software

An overview of the software available and their main characteristics are given below:

4

Software	Functions	Distinctive characteristics
Ekip Connect	<ul style="list-style-type: none"> - commissioning of circuit breakers - analysis of faults - testing of communication bus 	<ul style="list-style-type: none"> - simple and intuitive use - integrated with DOC electrical design software (IEC) - useable via EtherNet - automatic updating from the Internet - off-line mode - multi-media (smart phone, tablet or PC)
Ekip View	<ul style="list-style-type: none"> - supervision and control of communication networks - analysis of electrical value trends - condition monitoring 	<ul style="list-style-type: none"> - engineering free - analysis of past trends - customizable reports - access to the installation via the Internet - possibility of integrating third party devices
Ekip T&P interface	<ul style="list-style-type: none"> - testing of protection functions - ordinary maintenance of trip units 	<ul style="list-style-type: none"> - test signals can be pre-set or configured as desired - advanced graphical interface - generation of test reports

Ekip Connect

Ekip Connect enables data to be exchanged with one or more protection trip units, which:

- **Assists with system commissioning;** all system parameters and the protection thresholds can be set rapidly in the Ekip trip units because of to the easy and intuitive navigation pages of the software.
- **Permits rapid access to diagnostics;** it is possible to consult and download the records of events, alarms and trip history, thereby facilitating the identification and understanding of the anomalies.

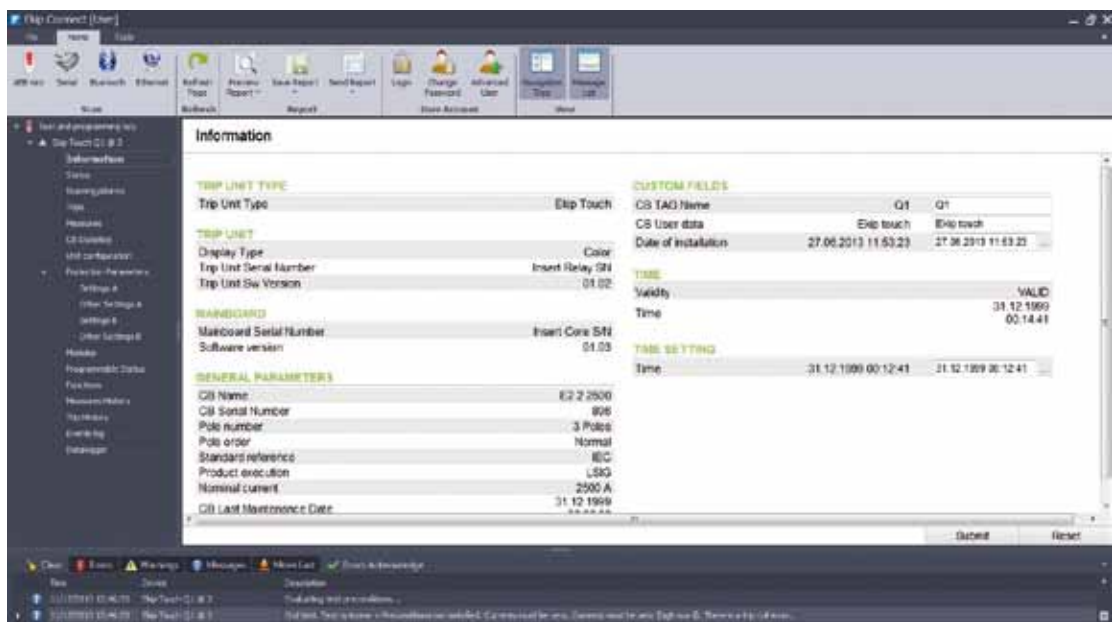

- **Enables testing of the communication network;** Ekip Connect performs an automatic scan of the Modbus RS-485 or Modbus TCP network and determines whether the circuit breakers have been correctly connected and, when necessary, signals incorrect configurations of the communication parameters (addresses, baud rate, parity).

The distinctive characteristics of the software are:

- **Integration with DOC electrical design software (IEC only);** the adjustments and settings calculated by the DOC software can be downloaded directly into the protection trip units, thereby reducing commissioning times and the potential for errors.
- **Ease of connection:** Ekip trip units equipped with Modbus TCP Ekip Com modules can be controlled directly by the EtherNet network.
- **Multi-media;** Ekip Connect is designed to operate on a PC or on the more modern tablet PCs and smart phones.
- **Automatic updating from the Internet;** if connected to the Internet, the software is able to constantly control the availability of any updates.

The software is available free of charge on the ABB website www.abb.com/lowvoltage.

Media	Ekip Connect Software				
	Personal PC			Smartphone/Tablet	iPhone/iPad
Operating system	Windows XP, Windows 7, Windows Vista			Android	iOS
Method of connection to the trip units	Communication network	Test connector	Wireless communication	Wireless communication	Wireless communication
SACE Emax 2 trip units	Ekip Com Modbus RS485 or TCP	Ekip T&P	Ekip Bluetooth	Ekip Bluetooth	Ekip Bluetooth
SACE Tmax XT trip units	Ekip Com	Ekip T&P	Ekip Bluetooth	-	-
SACE Emax, T7, X1, T8 trip units	PR120/D-M, PR330/D-M	Ekip T&P or BT030	BT030	-	-
SACE Tmax T trip units	PR222DS/PD, PR223DS; PR223/EF	Ekip T&P or BT030	BT030	-	-
Functions of reading and control					
Automatic network scan	•	-	-	-	-
Circuit breaker opening and closing ¹⁾	•	•	•	•	•
Setting of thresholds	•	•	•	•	•
Resetting of alarms	•	•	•	•	•
Reading of electrical measurements	•	•	•	•	•
Displaying of time-current curve	•	•	•	•	•
Reading of past records	•	•	•	•	•
DataLogger download	•	•	•	-	-
Other functions					
Report generation	•	•	•	•	•
Automatic updating from Internet	•	•	•	•	•
Integration with DOC (IEC)	•	•	•	•	•
Enabling of Ekip T&P Interface	•	•	•	•	•
Use via EtherNet	• ²⁾	-	-	-	-

1) Circuit breakers equipped with auxiliary contacts to indicate position

2) only in the presence of Modbus TCP Ekip Com modules

Communication devices and systems

Supervision and control software

Ekip View

Ekip View is the software for supervising devices connected to a communication network that uses a Modbus RTU or Modbus TCP protocol.

It is the ideal tool for all applications that require:

- remote control of the system,
- monitoring of power consumption,
- fault detection of the system,
- allocation of energy consumption to the different processes and departments,
- preventative planning of maintenance.

4

The main characteristics of Ekip View are:

- **Engineering free** and ready to use **software** which guides the user in the recognition and configuration of the protection units without the need for any supervision system engineering activities.
- **Dynamic mimic panel**; after automatic scanning of the network, for each of the devices found, Ekip View proposes a dynamic symbol that summarizes the most important information (status, electrical measurements, alarms). The extensive library of electrical symbols enables the entire electrical system to be depicted in detail.
- **Analysis of trends**; the instantaneous and past trends of currents, powers and power factors are represented graphically and can be exported into Microsoft Excel for detailed analysis.
- **Reports**; advanced reports can be created regarding system and communication network diagnostics. Using the Alarm Dispatcher option, the user can receive the most important indications via SMS or e-mail.
- **Access via web** to the installation, due to the Web Server function of Ekip View.

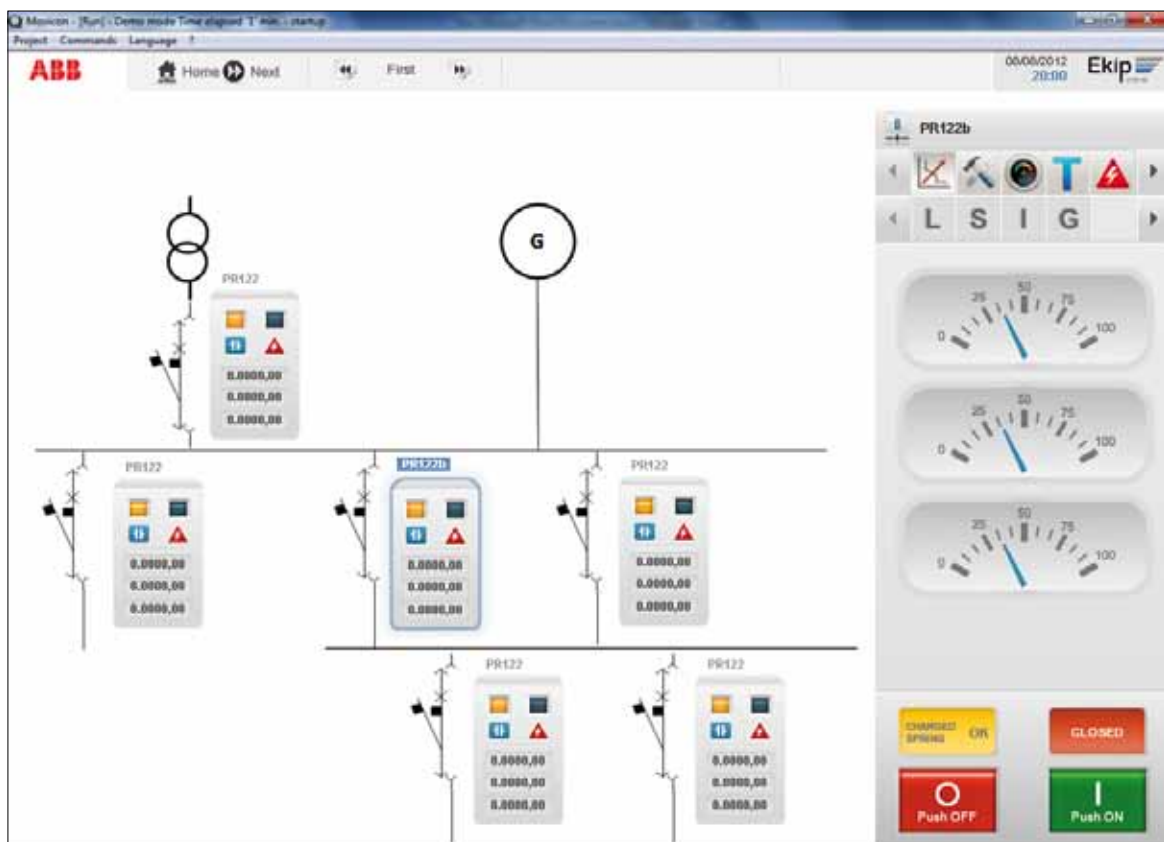

Ekip View Software

Communication characteristics

Protocol Supported	Modbus RTU	Modbus TCP
Physical layer	RS 485	EtherNet
Maximum data exchange rate	19200 bps	100 Mbps
Operating system	Windows XP, Windows 7, Windows Vista	

Devices supported

SACE Emax 2 trip units	Ekip com Modbus RS485	Ekip com Modbus TCP
SACE Emax, T7, X1, T8 trip units	PR120/D-M, PR330/D-M	-
SACE Tmax T trip units	PR222DS/PD, PR223DS	-
SACE Tmax XT trip units	Ekip com	-
Third party devices	optional ¹⁾	optional ¹⁾
Licences available	- up to 30 ²⁾ controllable devices - up to 60 ²⁾ controllable devices - unlimited number ³⁾ of controllable devices	

Supervision and control functions

Circuit breaker opening and closing ⁴⁾	•	•
Electrical value trends	•	•
Log of electrical value trends	•	•
Dynamic installation mimic panel	•	•
Automatic scanning	•	•
Centralized synchronizing of time	•	•
Web server function	• ⁵⁾	• ⁵⁾
Redundancy	optional	optional
OPC server-client	optional	optional

Measurement functions ⁶⁾

Currents	•	•
Voltages	•	•
Powers	•	•
Energies	•	•
Harmonics	•	•
Network Analyzer	•	•
Data logger	•	•

Adjustment functions

Setting of thresholds	•	•
Resetting of alarms	•	•

Diagnostics

Protection function alarms	•	•
Device alarms	•	•
Communication system alarms	•	•
Protection unit tripping details	•	•
Events log	•	•
Protection unit tripping log	•	•
Report generation	•	•
Transmission of alarms via SMS	optional	optional
Transmission of alarms via e-mail	optional	optional

Maintenance

Number of operations	•	•
Number of trips	•	•
Contact wear (endurance)	•	•

Other data

Circuit breaker status	•	•
Circuit breaker position ⁷⁾	•	•
local/remote mode	•	•

1) Contact ABB to integrate other devices in the Ekip View software

2) can be increased

3) within the physical limit of the protocol used

4) circuit breakers equipped with Ekip com Actuator module and electrical accessories

5) two client web accesses included in the licence, optional accesses for up to 5

6) according to the values supported by the trip units

7) circuit breakers equipped with auxiliary contacts for position indication

Communication devices and systems

Supervision and control software

Ekip T&P Interface

The Ekip T&P Interface software, used together with the Ekip T&P device, enables the electronic protection trip units to be tested for correct operation during the stages of commissioning and system maintenance.

As a result of advanced graphical interfaces, the user can simply select the test to perform: from simple current and voltage signals to more complex wave forms with the presence of harmonic distortion.

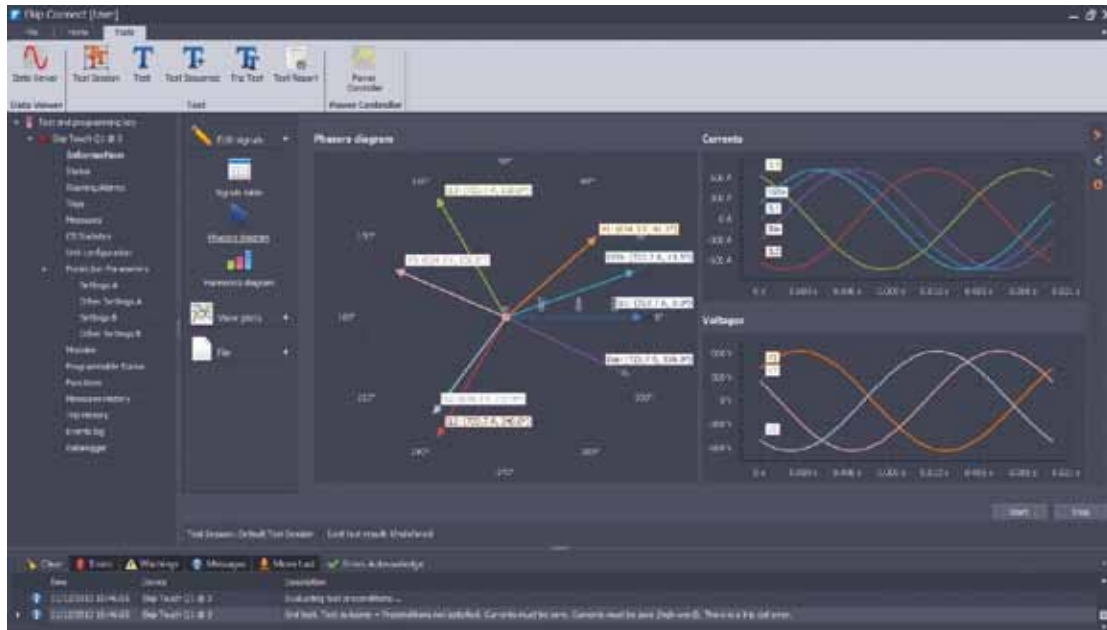

1SDC2000497F001

The software creates and stores all reports, keeping a record of the tests carried out and essential information such as the operator name, date, serial number of the circuit breaker, type of test and the result.

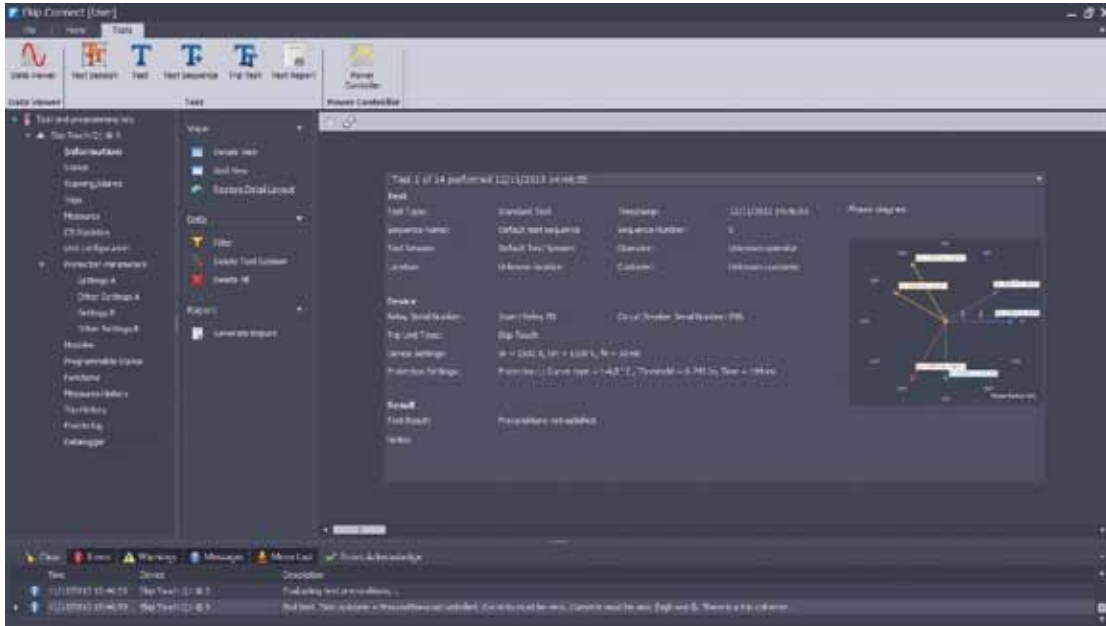

1SDC200488F001

Accessories

Functional areas	5/2
Standard supply	5/4
Circuit breaker accessories	5/6
Signalling	5/7
Control	5/10
Safety	5/15
Protection devices	5/16
Connections	5/18
Interlocks and switching devices	5/20
Ekip trip unit accessories	5/23
Power supply	5/25
Connectivity	5/25
Signalling	5/27
Measurements and protection	5/28
Displaying and supervision	5/32
Testing and programming	5/33
Spare parts	5/34

Accessories

Functional areas

The new SACE Emax 2 circuit breakers have been designed to optimize the installation and commissioning of accessories.

The front of the circuit breaker features two functional areas, which are protected by separate covers:

- **Accessories area** for the installation of accessories inside the circuit breaker and Ekip trip unit. The areas dedicated to accessories can be accessed by removing the flange and the accessories cover. On removal, the operating mechanism area remains segregated and protected, providing safety for operators.
- **Safety area**, for housing the stored energy operating mechanism of the circuit breaker. To carry out maintenance on the operating mechanism, the cover of the accessories and safety area must be removed.

5



As a result of two distinct functional areas that determine the operating spaces, the accessorizing logic of the circuit breakers has been considerably simplified.

The auxiliary connection terminal box also features two areas:

- **Terminal area** for housing and inserting the terminals for wiring the auxiliary connections. The terminals can be wired first and then installed in the circuit breaker terminal box, thereby facilitating cable connection for the operator.
- **Cartridge module area** for housing for the Ekip modules. These are installed directly on the upper part of the circuit breaker or of the cradle without having to remove the Ekip electronic trip unit, thereby minimizing the time required for the installation and commissioning of accessories.

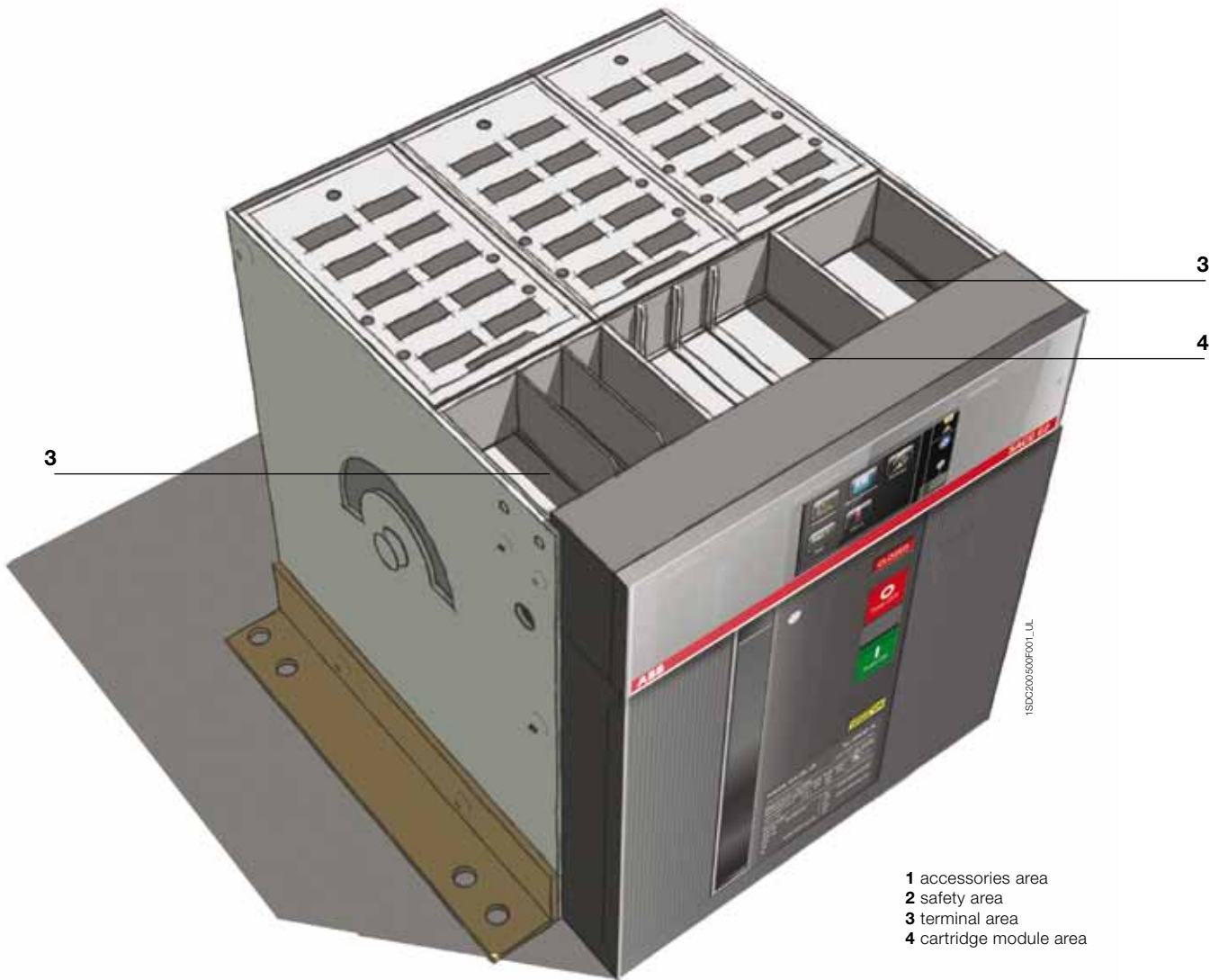

Accessories

Standard supply

The fixed versions of SACE Emax 2 automatic circuit breakers and switch disconnectors are always supplied as standard with the following accessories:

- IP30 protection for switchgear door (door escutcheon)
- lifting plates for E2.2 through E6.2 circuit breakers
- front terminals for E1.2 circuit breaker
- adjustable rear terminals for E2.2 through E6.2 circuit breakers, mounted in HR – HR configuration, with exception for E4.2 L version, E4.2 3200A and E6.2 6000A in which they are supplied in VR - VR configuration.

In addition, for fixed automatic circuit breakers only:

- four standard open/closed auxiliary contacts - AUX 4Q (4 Form C)
- four terminal blocks for auxiliary connections
- mechanical signalling of the tripping of the protection trip unit - TU Reset
- Ekip TT power supply and test unit, for displayed trip units
- trip signalling contact (S51 / bell alarm).

5

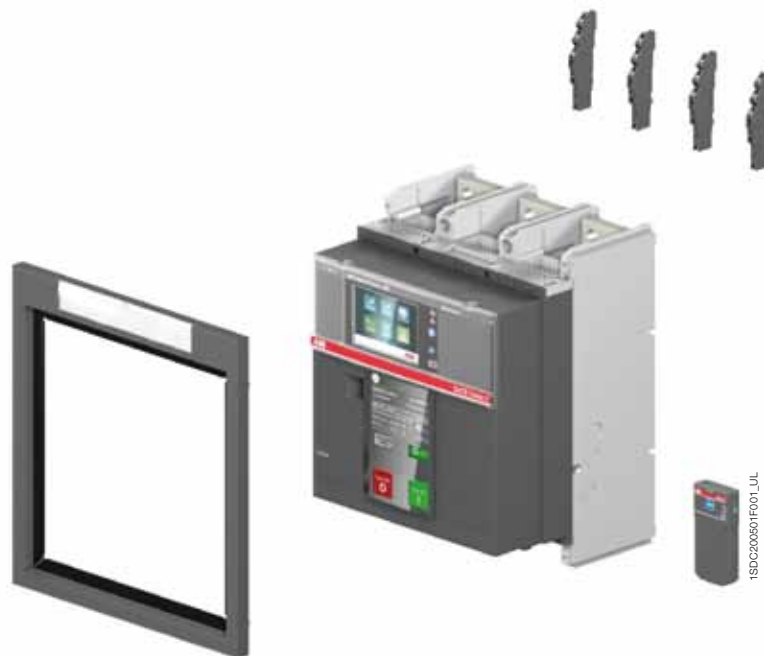

The drawout versions of circuit breakers and switch disconnectors are always supplied as standard with the following accessories:

- closed circuit breaker racked out mechanism lock
- lifting plates for E2.2 through E2.6 circuit breakers
- lever for racking in and racking out
- anti-insertion lock
- anti-racking out device (fail safe).

In addition, for drawout circuit breakers only:

- four standard open/closed auxiliary contacts - AUX 4Q (4 Form C)
- four terminal blocks for auxiliary connections
- mechanical signalling of the tripping of the protection trip unit - TU Reset
- Ekip TT power supply and test unit, for displayed trip units
- trip signalling contact (S51 / bell alarm).

The cradles feature:

- IP30 protection for switchgear door (door escutcheon)
- anti-insertion lock
- standard shutter lock – SL
- adjustable rear terminals, mounted in HR – HR configuration, with exception for E4.2 L version, E4.2 3200A and E6.2 6000A in which they are supplied in VR - VR configuration..



Accessories

Circuit breaker accessories

SACE Emax 2 circuit breakers offer a wide range of accessories developed to satisfy the application and installation requirements of every customer.

	Automatic circuit breaker		Switch disconnecter	
	E1.2	E2.2 - E4.2 - E6.2	E1.2	E2.2 - E4.2 - E6.2
Signalling				
Standard open/closed auxiliary contacts - AUX 4Q (4 Form C)	● / ●●	● / ●●	○ / ○○	○ / ○○
Open/closed auxiliary contacts - AUX 6Q (6 Form C)	-	○ / ○○	-	○ / ○○
Open/closed auxiliary contacts- AUX 15Q (15 Form C)	○ / ○○	○ / ○○	○ / ○○	○ / ○○
Auxiliary position contacts - AUP	●	●	●	●
Ready to close signalling contact - RTC	○ / ○○	○ / ○○	○ / ○○	○ / ○○
TU Reset mechanical signalling of the tripping of protection trip unit - TU Reset	● / ●●	● / ●●	-	-
Trip signalling contact - S51 / bell alarm	● / ●●	● / ●●	-	-
Contact signalling loaded springs – S33 M/2 (supplied with Motor)	○ / ○○	○ / ○○	○ / ○○	○ / ○○
Control				
Shunt trip / closing coil - YO/YC	○ / ○○	○ / ○○	○ / ○○	○ / ○○
Second shunt trip / closing coil - YO2/YC2	○ / ○○	○ / ○○	○ / ○○	○ / ○○
Undervoltage release - YU	○ / ○○	○ / ○○	○ / ○○	○ / ○○
Electronic time-delay device for undervoltage release - UVD (IEC only)	○ / ○○	○ / ○○	○ / ○○	○ / ○○
Motor - M	○ / ○○	○ / ○○	○ / ○○	○ / ○○
Remote reset - YR	○ / ○○	○ / ○○	-	-
Shunt trip and closing coil test unit - YO/YC Test Unit (IEC only)	○ / ●	○ / ●	○ / ●	○ / ●
Safety				
Anti-racking out device (fail safe) - FS	●●	●●	●●	●●
Key lock and padlock in open position - KLC and PLC	○ / ○○	○ / ○○	○ / ○○	○ / ○○
Key lock and padlock in racked in / test / racked out position - KLP and PLP	●	○○	●	○○
Shutter lock - SL	●	●	●	●
Lock for racking-out mechanism with circuit breaker in closed position	●	●●	●	●●
Lock for racking in / racking out the mobile part when the door is open - DLR	-	●	-	●
Lock to prevent door opening when circuit breaker is in racked in / test position - DLP	-	●	-	●
Lock to prevent door opening when circuit breaker is in closed position - DLC	○ / ○○	○ / ○○	○ / ○○	○ / ○○
Anti-insertion lock	● / ●●	● / ●●	● / ●●	● / ●●
Mechanical operation counter - MOC	○ / ○○	○ / ○○	○ / ○○	○ / ○○
Protection devices				
Protection device for opening and closing pushbuttons - PBC	○ / ○○	○ / ○○	○ / ○○	○ / ○○
IP30 Protection (door escutcheon)	● / ●	● / ●	● / ●	● / ●
IP54 Protection (door escutcheon)	○ / ●	○ / ●	○ / ●	○ / ●
Terminal covers - HTC / LTC	○ / ○○	-	-	-
Phase barriers - PB	○ / ○○	-	-	-
Connections				
Adjustable rear terminal - HR/VR	○	●	○	●
Front terminal - F	●	○	●	○
Other configurations	○ / ●	-	○ / ●	-
Interlocks and switching devices				
Mechanical interlock - MI	○ / ○○ / ●	○ / ○○ / ●	○ / ○○ / ●	○ / ○○ / ●
Automatic transfer switches - ATS (IEC only)	○ / ○○	○ / ○○	○ / ○○	○ / ○○

- Standard accessory for fixed circuit breaker
- Accessory on request for fixed circuit breaker
- Standard accessory for mobile part
- Accessory on request for mobile part
- Standard accessory for cradle
- Accessory on request for cradle



1SDC200039D0201

Signalling

Open / closed auxiliary contacts - AUX

SACE Emax 2 circuit breakers can be equipped with auxiliary contacts that signal the open or closed status of the circuit breaker. The first block of four standard contacts is always provided with the automatic circuit breakers. The switching contacts are available in the following configurations:

Open / closed auxiliary contacts - AUX 4Q (4 Form C)		E1.2	E2.2 ... E6.2
4 auxiliary contacts	standard	•	•
	digital signals	•	•
	mixed	•	•
Open / closed supplementary auxiliary contacts - AUX 6Q (6 Form C)			
6 auxiliary contacts	standard	-	•
	digital signals	-	•
	mixed	-	•
Open / closed external supplementary auxiliary contacts - AUX 15Q (15 Form C)			
15 auxiliary contacts	standard	•	•
	digital signals	•	•
Maximum number of open / closed auxiliary contacts that can be installed		19	25



1SDC200039D0201



1SDC200039D0201

		Standard contact	Contact for digital signals
Type		changeover contacts	changeover contacts
Minimum load		100mA @ 24V	1mA @ 5V
Breaking capacity			
DC	24V	-	0.1A
	125V	0.3A @ 0ms	-
	250V	0.15A @ 0ms	-
AC	250V	5A @ cosφ 1	-
		5A @ cosφ 0.7	-
		5A @ cosφ 0.3	-
	400V	3A @ cosφ 1	-
		2A @ cosφ 0.7	-
		1A @ cosφ 0.3	-

Electrical diagram reference: figure 1, 81, 91

Aux 6Q (6 Form C) is an alternative to the Ekip Signalling 4K module. AUX 15Q (15 Form C) is an alternative to the mechanical interlock (MI), the lock to prevent door opening when the circuit breaker is in the closed position (DLC) or the lock to prevent door opening when the circuit breaker is in the racked in or test position (DCP) if mounted on the right side.

Accessories

Circuit breaker accessories

5



1SDC2003060F001

Auxiliary position contacts - AUP

When the circuit breaker is a drawout version, the position of the mobile part can be signalled electrically by accessorizing the cradle with one of the following signalling contact units:

Auxiliary position contacts (AUP)		E1.2	E2.2 ... E6.2
6 auxiliary contacts	standard	•	-
	digital signals	•	-
5 auxiliary contacts	standard	-	•
	digital signals	-	•
5 supplementary auxiliary contacts	standard	-	•
	digital signals	-	•
Maximum number of auxiliary position contacts that can be installed		6	10
		Standard contact	Contact for digital signals
Type		changeover contacts	changeover contacts
Minimum load		100mA @ 24V	1mA @ 5V
Breaking capacity			
DC	24V	-	0.1A
	125V	0.3A @ 0ms	-
	250V	0.15A @ 0ms	-
AC	250V	5A @ cosφ 1	-
		5A @ cosφ 0.7	-
		5A @ cosφ 0.3	-
	400V	3A @ cosφ 1	-
		2A @ cosφ 0.7	-
		1A @ cosφ 0.3	-

Electrical diagram reference: figure 95, 96, 97



1SDC2003070F001

Ready to close signalling contact - RTC

The ready to close signalling contact – RTC – indicates that the circuit breaker is ready to receive the closing command. The circuit breaker is ready to close when the following conditions have been met:

- circuit breaker open
- springs loaded
- no opening command or locks on the opening command
- circuit breaker reset following tripping of Ekip protection trip unit.



1SDC2003080F001

		Standard contact	Contact for digital signals
Type		Switching	
Minimum load		100mA @ 24V	1mA @ 5V
Breaking capacity			
DC	24V	-	0.1
	250V	0.5A @ 0ms / 0.2A 10ms	-
AC	250V	3A @ cosφ 0.7	-

Electrical diagram reference: figure 71



1SDC20069F001

Mechanical signalling of the tripping of the protection trip unit - TU Reset

The automatic circuit breakers are always equipped with a mechanical device that signals the tripping status of the protection trip units. After the Ekip trip unit has tripped due to an electrical fault, the signalling device clearly indicates the tripping status on the front of the circuit breaker. The circuit breaker can be reset only after the signalling pushbutton has been restored to its normal operating position. The device conforms to the ANSI 86T standard.

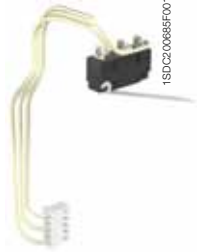

1SDC20069F001

Trip signalling contact - S51 / bell alarm

The contact signals the opening of the circuit breaker after the Ekip protection trip unit has tripped. The circuit breaker can only be closed after the "TU Reset" tripped trip unit mechanical signalling pushbutton has been restored to its normal operating position. The switching contact, which is always supplied with the standard version of the automatic circuit breakers, is also available on request in a version for digital signals. It can also be associated with an optional accessory for resetting by remote control - YR. For electromechanical characteristics, please refer to the RTC contact.

Electrical diagram reference: figure 11

Contact signalling loaded springs – S33 M/2

This contact is always supplied with a geared motor in its standard (250V) format. It remotely signals the spring status of the circuit breaker operating mechanism. It is available in both a standard version and a 24V version for digital signals.

		Standard contact	Contact for digital signals
Type		changeover contacts	changeover contacts
Minimum load		100mA @ 24V	1mA @ 5V
Breaking capacity			
DC	24V	-	0.1A
	125V	0.3A @ 0ms	-
	250V	0.15A @ 0ms	-
AC	250V	5A @ cosφ 1	-
		5A @ cosφ 0.7	-
		5A @ cosφ 0.3	-
	400V	3A @ cosφ 1	-
		2A @ cosφ 0.7	-
		1A @ cosφ 0.3	-

Electrical diagram reference: figure 12

Accessories

Circuit breaker accessories



Control

Shunt trip / closing coil - YO/YC

The shunt trip and closing coil enable the circuit breaker to be controlled remotely. Opening is always possible, while closing is available only when the closing springs of the operating mechanism are loaded and the circuit breakers is ready to close.

The releases operate by means of a minimum impulse current duration time of 100 ms.

Furthermore, they can operate in permanent service. In this case, if an opening command is given by means of the shunt trip, the circuit breaker can be closed by de-energizing the shunt trip and (after a time of at least 30ms) by supplying a closing command.

Electrical diagram reference: figure 75, 77

Second shunt trip / closing coil - YO2/YC2

For certain installations the redundancy of mechanisms and circuit breaker operating circuits is often requested. To answer these needs, SACE Emax 2 circuit breakers can be equipped with double shunt trips and double closing coils. The technical characteristics of the second accessories remain the same as those of the first.

A second closing coil can be used for E2.2, E4.2 and E6.2 circuit breakers. A second shunt trip can be used as an alternative to the undervoltage release or anti-racking out device on any breaker.

Electrical diagram reference: figure 72, 79

General characteristics

Power supply (Un)	AC	DC
24V	•	•
30V	•	•
48V	•	•
60V	•	•
110V...120V	•	•
120V...127V	•	•
220V...240V	•	•
240V...250V	•	•
277V	•	-
380V...400V	•	-
415V...440V	•	-
480V...500V	•	-
Operating limits	YO/YO2: 70%...110% Un YC/YC2: 85%...110% Un	
Inrush power (Ps)	300VA	300W
Continuous power (Pc)	3.5VA	3.5W
Opening time (YO/YO2)		
E1.2	35 ms	
E2.2 ... E6.2	35 ms	
Closing time (YC/YC2)		
E1.2	50 ms	
E2.2 ... E6.2	50 ms	

Shunt trip and closing coil test unit - YO/YC Test Unit (IEC only)

The shunt trip and closing coil test unit helps ensure that the various versions of releases are running smoothly, to guarantee a high level of reliability in controlling circuit breaker opening. The test unit ensures the continuity of the shunt trips and closing coils with a rated operating voltage between 24V and 250V (AC and DC), as well as verifies the functions of the electronic circuit.

Continuity is checked cyclically with an interval of 20s between tests. The unit has optic signals via LEDs on the front, which provide the following information:

- POWER ON:** power supply present
- TESTING:** testing in progress
- TEST FAILED:** signal following a failed test or lack of auxiliary power supply
- ALARM:** signal given following three failed tests.

Two relays with one change-over area also available on board the unit, to allow remote signalling of the following events:

- Failure of a test** - resetting takes place automatically when the alarm stops
- Failure of three tests** - resetting occurs only by pressing the manual RESET on the unit.

Characteristics of device	
Auxiliary power supply	24V...250V AC/DC
Specification of the signalling relays	
Maximum interrupted current	6A
Maximum interrupted voltage	250V AC

Accessories

Circuit breaker accessories



1SDC2005 (0P001)

Undervoltage release – YU

The undervoltage release opens the circuit breaker when there is a significant voltage drop or power failure to its control signal. It can be used for safe remote tripping, for blocking closing or to control the voltage in the primary and secondary circuits. The power supply for the release is therefore obtained on the supply side of the circuit breaker or from an independent source. Circuit breaker closing is permitted only when the release is powered. The undervoltage release is an alternative to a second shunt trip or the anti-racking out device.

General characteristics

Power supply (Un)	AC	DC
24V	•	•
30V	•	•
48V	•	•
60V	•	•
110V...120V	•	•
120V...127V	•	•
220V...240V	•	•
240V...250V	•	-
277V	•	-
380V...400V	•	-
415V...440V	•	-
480V...500V	•	-
Operating limits	70%...110% Un	
Inrush power (Ps)	300VA	300W
Continuous power (Pc)	3.5VA	3.5W
Opening time (YU)		
E1.2	30 ms	
E2.2 ... E6.2	50 ms	

Electrical diagram reference: figure 73

Time-delay device for undervoltage release - UVD (IEC only)

The undervoltage release can be combined with an external electronic time-delay device for the circuit breaker, allowing for delayed tripping with adjustable preset times. Use of the delayed undervoltage trip unit is recommended to prevent tripping when the power supply network for the trip unit is subject to brief voltage drops or power supply failures. Circuit breaker closing is inhibited when it is not powered. The time-delay device must be used with an undervoltage release with the same voltage.

General characteristics

Power supply (UVD)	AC	DC
24-30V	-	•
48V	•	•
60V	•	•
110-127V	•	•
220-250V	•	•
Adjustable opening time (YU + D):	0.5-1-1.5-2-3 s	

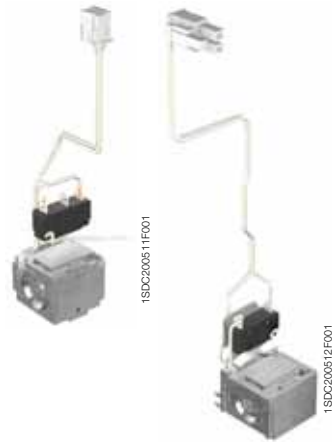

Remote reset - YR

The reset coil YR permits remote resetting of the circuit breaker after a release has tripped due to an overcurrent condition.

It is available for all automatic circuit breakers, in different voltage supplies:

General characteristics

Power supply (Un)	AC	DC
24V	•	•
110V	•	•
220V	•	•
Operating limits	90%...110% Un	

Electrical diagram reference: figure 14

Accessories

Circuit breaker accessories



Motor – M

The spring charge motor automatically loads the closing springs of the circuit breaker. The device, which can be installed from the front, automatically reloads the springs of the operating device when they are unloaded and power is present. In the event that no power is present, the springs can be manually loaded by a dedicated lever on the operating device. The motor is always supplied with the limit switch contact S33 M/2 which signals the status of the springs.

General characteristics

Power supply (Un)	AC	DC
24V-30V	•	•
48V-60V	•	•
100V...130V	•	•
220V...250V	•	•
277V ¹⁾	•	-
380V...415V	•	-
440V...480V (E2.2 ... E6.2)	•	-
Operating limits	85%...110% Un	
Inrush power (Ps)	300VA E1.2 500VA E2.2 ... E6.2	300W E1.2 500W E2.2 ... E6.2
Inrush time	200ms	
Continuous power (Pc)	100VA E1.2 150VA E2.2 ... E6.2	100W E1.2 150W E2.2 ... E6.2
Charging time		
E1.2	8 sec	
E2.2 ... E6.2	8 sec	

1) A 277V motor is available for E2.2 through E6.2
Electrical diagram reference: figure 13

Safety

Anti-racking out device / Fail safe - FS

The anti-racking out, or fail safe device prevents the moving part of a drawout circuit breaker from being racked out of the cradle when the springs are charged. It is always supplied with the moving part of a UL version drawout circuit breaker or switch and is an alternative to the undervoltage release or second shunt trip.



1SDC200515F001



1SDC200516F001



1SDC200517F001



1SDC200518F001



1SDC200519F001



1SDC200520F001



1SDC200521F001

Key lock in open position - KLC

Due to these safety devices, the SACE Emax 2 circuit breakers can be locked in the open position. The lock can also be used during maintenance activities when the shield of the accessories area is removed. The device is available as a lock with different keys – KLC-D (for only one circuit breaker) or with the same keys – KLC-S (for several circuit breakers).

Four different key numbers are available for the KLC-S.

SACE Emax 2 also allows alternative key locks to be installed. The following key lock adapters are also available:

- Ronis
- Profalux
- Kirk
- Castell

In this case, the key locks must be supplied by the customer.

Padlocks - PLC

The padlock options allow the circuit breaker to be kept open by acting directly on the mechanical operating device (opening pushbutton). Three different padlock versions are available:

- Locking device with plastic structure for up to a maximum of three padlocks of 4mm/0.15"
- Locking device with metal structure for up to a maximum of two padlocks of 8mm/0.31"
- Locking device with metal structure for one padlock of 7mm/0.27" or for padlock hasps

The padlocks must be supplied by the customer. This device is an alternative to the protection device for opening and closing pushbuttons (PBC).

Key lock in racked in / test / racked out position - KLP

This device enables the mobile part to be locked in one of the three positions: racked in, test and racked out.

This device can be supplied with locks with different keys – KLP-D or with the same keys – KLP-S. A second key lock option can be added for a maximum of two key locks per breaker. Locking in the racked in, test and racked out positions can be achieved by using other key locks – KLP-A. Adapters are offered for acceptance of Ronis, Profalux, Kirk and Castell locks, which are to be provided by the customer. With the exception of the Castell version, every circuit breaker can accept up to two key locks. Moreover, it is possible to allow locking only when in the racked out position with a supplementary lock in racked out position accessory.

Padlock in racked in / test / racked out position - PLP

This device can hold up to three padlocks of 8mm/0.31" in diameter. The structure housing the padlocks can also be used in combination with the 2nd key KLP keylock option. Furthermore, it enables the lock of the moving part in the racked out position only by means of the supplementary lock in racked out position.

Shutter lock – SL

When the mobile part of a drawout unit is in the test position, the shutters of the cradle close, maintaining the insulation distance and physically segregating the live parts of the of the cradle from the internal breaker compartment of the cradle. Using two dedicated mechanisms, the upper and lower shutters can be locked independently of one another. The shutter lock is always supplied with the cradle of the SACE Emax 2 circuit breakers and locks the shutters, using a maximum of three padlocks of 4mm/0.15", 6mm/0.23" or 8mm/0.31". The padlocks are supplied by the customer.

Accessories

Circuit breaker accessories



Protection devices

Lock for racking out mechanism with circuit breaker in closed position

SACE Emax 2 drawout circuit breakers are always supplied with a lock that prevents the mobile part from being racked in and racked out when the circuit breaker is in the closed position. To rack in the mobile part, the circuit breaker must be in the open position.

Lock for racking in / racking out the mobile part when the door is open - DLR

This accessory, which is mounted on the cradle, prevents the mobile part from being racked in or out when the switchgear door is open.

Lock to prevent door opening when the circuit breaker is in racked in / test position - DLP

This safety device prevents the switchgear door from being opened when the mobile part of the drawout version of the circuit breaker is in the racked in or test position.

The circuit breaker can only be racked in when the door is open. This accessory can be installed on either the right or left side of the cradle. It is available for the E2.2, E4.2 and E6.2 circuit breakers. If mounted on the right side, it is an alternative to the mechanical interlock, the AUX 15Q (15 Form C) or the DLC lock.



Lock to prevent door opening when the circuit breaker is in the closed position - DLC

This prevents the compartment door from being opened when the circuit breaker is in the closed position (and with the circuit breaker racked in for drawout circuit breakers). It also blocks the circuit breaker from closing when the compartment door is open. It is an alternative to the mechanical interlock, the AUX 15Q (15 Form C) or the DLP if mounted on the right side.

Anti-insertion lock

The withdrawable circuit breakers are equipped with special locks that allow the mobile part to be inserted only into the corresponding cradle.



Mechanical operation counter - MOC

The number of mechanical operations is often one of the elements that determines the frequency of ordinary maintenance operations on circuit breakers. With the mechanical operation counter, which is always visible on the front of the circuit breaker, the user knows how many mechanical operations the device has performed.



Protection device for opening and closing pushbuttons - PBC

This accessory is applied to the safety cover of the circuit breaker and is available in two versions:

- Pushbutton protection device, which blocks operations on both the opening and closing pushbuttons unless the special key is used.
- Padlockable pushbutton protection device, which makes it possible to block either or both pushbuttons and lock the covers in place. It does not trip the breaker as a standard "Padlock device" would.
- This device is an alternative to PLC padlocks.



IP30 Protection (door escutcheon)

Supplied with every circuit breaker, the cover frame is installed on the door of the switchgear to achieve an IP30 degree of protection on the front part of the circuit breaker.



IP54 Protection (door escutcheon)

This transparent cover completely protects the front of the circuit breaker, enabling an IP54 degree of protection to be achieved. This accessory is provided with double key lock (same or different keys).



Terminal covers – HTC / LTC

These accessories are installed over the terminal area, thereby reducing the risk of direct contact with the live parts of the circuit breaker. Two versions are available for E1.2: HTC high terminal covers and LTC low terminal covers.



Phase barriers - PB

These protection devices increase the insulation distance between adjacent phases. They are available for all the frames.

Accessories

Circuit breaker accessories

Connections

The SACE Emax 2 circuit breakers to ANSI C37 / UL 1066 offer a wide variety of terminals, thereby always guaranteeing an optimal solution for connection to the power circuit.

Solution for fixed circuit breakers

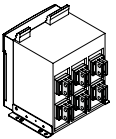
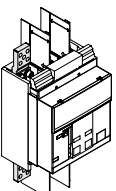
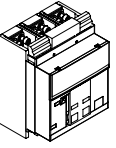
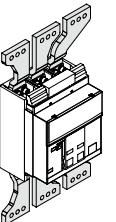
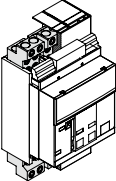
Type	Abbreviation		E1.2	E2.2	E4.2	E6.2
Rear adjustable terminal *	HR VR		Single stab design			
			○			
Extended front terminal	EF		Multiple stab design			
				●	●	●
Front terminal	F		●	○	○	○
Front spread terminal	ES		○			
Terminal for cable FcCuAl 4x500kcmil / 240mm ²	FcCuAl		○			

● Standard configuration

○ Configuration on request

(*) The adjustable terminals are supplied as standard in the HR – HR configuration, with exception for E4.2 L version, E4.2 3200A and E6.2 6000A in which they are supplied in VR - VR configuration.

Solutions for cradles, drawout circuit breakers

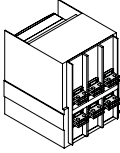
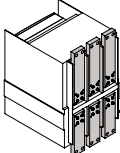
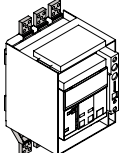
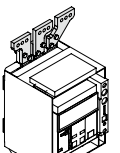
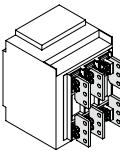
Type	Abbreviation		E1.2	E2.2	E4.2	E6.2
Rear adjustable terminal *	HR VR		Single stab design			
			●			
Front terminal	F		Multiple stab design			
				●	●	●
Extended front terminal	EF		○			
Front spread terminal	ES		○			
Terminal for cable FcCuAl 4x500kcmil / 240mm ²	Fc CuAl		○			

- Standard configuration
- Configuration on request

(*) The adjustable terminals are supplied as standard in the HR – HR configuration, with exception for E4.2 L version, E4.2 3200A and E6.2 6000A in which they are supplied in VR - VR configuration.

Accessories

Circuit breaker accessories

Interlocks and switching devices

Mechanical interlocks

These interlock systems enable various opening and closing configurations to be obtained between two or three circuit breakers. Four types of interlock configuration are available:

Types of interlock	Possible application	Logic	Circuit breakers																								
Type A Excludes the possibility of having two circuit breakers in the closed position at the same time.	Main line power supply and emergency power supply. 	<table border="1"> <thead> <tr> <th>1</th> <th>2</th> </tr> </thead> <tbody> <tr> <td>O</td> <td>O</td> </tr> <tr> <td>I</td> <td>O</td> </tr> <tr> <td>O</td> <td>I</td> </tr> </tbody> </table>	1	2	O	O	I	O	O	I	Available between circuit breakers of different sizes and with any fixed / drawout version																
1	2																										
O	O																										
I	O																										
O	I																										
Type B Permits a pair of circuit breakers to be closed if the third is open. The latter can only be closed when the pair is open.	Two power supplies from transformers and one emergency power supply. 	<table border="1"> <thead> <tr> <th>1</th> <th>2</th> <th>3</th> </tr> </thead> <tbody> <tr> <td>O</td> <td>O</td> <td>O</td> </tr> <tr> <td>I</td> <td>O</td> <td>O</td> </tr> <tr> <td>O</td> <td>O</td> <td>I</td> </tr> <tr> <td>I</td> <td>O</td> <td>I</td> </tr> <tr> <td>O</td> <td>I</td> <td>O</td> </tr> </tbody> </table>	1	2	3	O	O	O	I	O	O	O	O	I	I	O	I	O	I	O	Available between E2.2, E4.2 and E6.2 circuit breakers and with any fixed / drawout version						
1	2	3																									
O	O	O																									
I	O	O																									
O	O	I																									
I	O	I																									
O	I	O																									
Type C Permits two out of three circuit breakers to be closed at the same time.	Two half-busbars can be powered by a single transformer (bus-tie closed) or by both at the same time (bus-tie open). 	<table border="1"> <thead> <tr> <th>1</th> <th>2</th> <th>3</th> </tr> </thead> <tbody> <tr> <td>O</td> <td>O</td> <td>O</td> </tr> <tr> <td>I</td> <td>O</td> <td>O</td> </tr> <tr> <td>O</td> <td>I</td> <td>O</td> </tr> <tr> <td>O</td> <td>O</td> <td>I</td> </tr> <tr> <td>O</td> <td>I</td> <td>I</td> </tr> <tr> <td>I</td> <td>I</td> <td>O</td> </tr> <tr> <td>I</td> <td>O</td> <td>I</td> </tr> </tbody> </table>	1	2	3	O	O	O	I	O	O	O	I	O	O	O	I	O	I	I	I	I	O	I	O	I	Available between E2.2, E4.2 and E6.2 circuit breakers and with any fixed / drawout version
1	2	3																									
O	O	O																									
I	O	O																									
O	I	O																									
O	O	I																									
O	I	I																									
I	I	O																									
I	O	I																									
Type D Permits one out of three interlocked circuit breakers to be closed.	Three power supplies on the same busbar that must not operate in parallel. 	<table border="1"> <thead> <tr> <th>1</th> <th>2</th> <th>3</th> </tr> </thead> <tbody> <tr> <td>O</td> <td>O</td> <td>O</td> </tr> <tr> <td>I</td> <td>O</td> <td>O</td> </tr> <tr> <td>O</td> <td>I</td> <td>O</td> </tr> <tr> <td>O</td> <td>O</td> <td>I</td> </tr> </tbody> </table>	1	2	3	O	O	O	I	O	O	O	I	O	O	O	I	Available between E2.2, E4.2 and E6.2 circuit breakers and with any fixed / drawout version									
1	2	3																									
O	O	O																									
I	O	O																									
O	I	O																									
O	O	I																									

The mechanical interlocks offer multiple solutions for installation that simplify their integration into the switchgear. The interlocks can be mounted:

- vertically **VR**
- horizontally **HR**
- mixed **L**

Different types of interlocks can be supplied according to the maximum distance between two interlocked breakers:

Configuration		Type A	Type B, C, D
Horizontal		9ft/2750mm	5.25ft/1600mm
Vertical		3.25ft/1000mm	3.25ft/1000mm
Breakers	E1.2	•	-
	E2.2	•	•
	E4.2	•	•
	E6.2	•	•

For B, C and D types, the maximum distance between the two furthest breakers is 10.5ft/3200mm for horizontal configurations and 6.5ft/2000mm for vertical configurations. It is possible to make the mechanical interlock among three circuit-breakers disposed in "L position" by using the cables of three horizontal circuit-breakers interlock. Make sure the distance between the horizontal and vertical circuit-breakers respect the minimum and maximum distance. All cables can be cut to guarantee easy installation in switchboards. Mechanical interlocks are not compatible with AUX 15Q (15 Form C), the locks for preventing door opening when the circuit breaker is in the closed position (DLC) or when the circuit breaker is in the racked in or test position (DLP) if mounted on the right side.

Automatic Transfer Switches ATS (IEC only)

The ATS (Automatic Transfer Switch) is a network-unit transfer device used in installations where switching from the main power line to an emergency line is required in order to ensure that power is supplied to the loads in the case of power loss or abnormalities from the main line.

These devices are able to control the entire transfer procedure automatically, but also offer commands for performing the procedure manually. In the event of loss or anomalies in the main line voltage, the opening of the main line circuit breaker, the starting of the generator set (if present) and the closing of the emergency line are activated according to the parameters set by the user. In the same way, when the main line returns to normal, the reverse transfer procedure is performed automatically. The new generation of ATSs (ATS021 and ATS022) offers the most advanced and complete solution for ensuring service continuity. The ATS021 and ATS022 devices can also be used with all automatic circuit breakers and switch disconnectors of the Tmax XT family.

The ATS021 and ATS022 devices have been designed to be self-powered. ATS022 is also designed for the connection of an auxiliary supply, which enables the use of further functions.

The ATS021 and ATS022 devices can control both power supply lines and also analyze:

- phase imbalance;
- frequency imbalance;
- phase loss.

In addition to the standard control functions, the ATS022 unit also permits:

- the priority line to be selected;
- a third circuit breaker to be controlled;
- the device to be integrated into a supervision system with Modbus communication (auxiliary supply needed);
- parameters to be read and set, and measurements and alarms to be displayed by means of a graphical display.

Typical applications are: supply of UPS (Uninterrupted Power Supply) units, operating rooms and primary hospital services, emergency power for civil buildings, airports, hotels, databases and telecommunication systems and power supply of industrial lines requiring continuous processes.

For correct configuration, each circuit breaker connected to the ATS021 or ATS022 device must be fitted with the following accessories:

- mechanical interlock;
- motorized control of opening and closing ;
- contact for signalling status (open / closed) and contact for signalling tripping;
- contact for signalling circuit breaker racked in (for drawout circuit breaker).

Accessories

Circuit breaker accessories



Technical characteristics

		ATS021	ATS022	
General	Auxiliary supply voltage	Not required	Not required (24-110V DC is required only for Modbus communication and systems of 16 2/3 Hz)	
	Supply voltage, Un	Max 480V AC	Max 480V AC	
	Frequency, fn	50, 60 Hz	16 2/3, 50, 60, 400 Hz	
	Dimensions 	H in/mm	3.78/96	3.78/96
		W in/mm	5.67/144	5.67/144
		D in/mm	6.79/170	6.79/170
	Type of installation	Installation on front of switchgear Installation on DIN rail	Installation on front of switchgear Installation on DIN rail	
Operating mode	Automatic/Manual	Automatic/Manual		
Characteristics	Monitoring of normal and emergency line	•	•	
	Control of circuit breakers on normal and emergency line	•	•	
	Setting start-up of generator	•	•	
	Setting switch-off of generator with settable time delay	•	•	
	Third circuit breaker	-	•	
	Selection priority line	-	•	
	Modbus Rs485 communication	-	•	
	Display	-	•	
Environmental conditions	Protection degree	IP20	IP20	
	Operating temperature	-20 ... +60 °C / -4...+140°F	-20 ... +60 °C / -4...+140°F	
	Humidity	5% - 90% without condensation	5% - 90% without condensation	
Operating thresholds	Undervoltage	-30% ... -5% Un	-30% ... -5% Un	
	Overvoltage	+5% ...+30% Un	+5% ...+30% Un	
	Frequency thresholds	-10% / +10% fn	-10% ... +10% fn	
Tests	Test Mode	•	•	
	Mode Test Gen set	•	•	
Standards	Electronic devices for use in electrical installations	EN-IEC 50178	EN-IEC 50178	
	Electromagnetic compatibility	EN 50081-2	EN 50081-2	
		EN 50082-2	EN 50082-2	
	Environmental conditions	IEC 68-2-1	IEC 68-2-1	
		IEC 68-2-2	IEC 68-2-2	
IEC 68-2-3		IEC 68-2-3		

Electrical diagram reference: figures 100,101 and 102.

Accessories

Ekip trip unit accessories

The electronic trip unit accessories enable utilization of all the potential of Ekip protection trip units in terms of signalling, connectivity, protection functions and testing.

	Electronic trip unit				
	Ekip DIP	Ekip Touch	Ekip Hi-Touch	Ekip G Touch	Ekip G Hi-Touch
Power supply					
Ekip Supply	○	○	○	○	○
Battery for Ekip trip units	○	○	○	○	○
Connectivity					
Ekip Com		○	○	○	○
Ekip Com Redundant		○	○	○	○
Ekip Com Actuator	○	○	○	○	○
Ekip Link	○	○	○	○	○
Ekip Bluetooth	○	○	○	○	○
Signalling					
Ekip Signalling 2K		○	○	○	○
Ekip Signalling 4K ⁽¹⁾		○	○	○	○
Ekip Signalling 10K	○	○	○	○	○
Ekip Power Controller		○	○	○	○
Measurement and Protection					
Ekip Measuring Pro		○	●	●	●
Ekip Measuring		○			
Ekip AUP	○	○	○	○	○
Ekip RTC	○	○	○	○	○
Ekip Synchrocheck		○	○	○	○
Ekip LCD		○	○	○	○
Rating Plug	○	○	○	○	○
Homopolar toroid		○	○	○	○
Toroid for differential protection (IEC only)		○	○	○	○
Current sensor for external neutral	○	○	○	○	○
Displaying and Supervision					
Ekip Multimeter	○	○	○	○	○
Ekip Control Panel	○	○	○	○	○
Testing and Programming					
Ekip TT	○	●	●	●	●
Ekip T&P	○	○	○	○	○
Ekip Programming	○	○	○	○	○

- Standard accessory
 - Accessory on request
- ⁽¹⁾ not available for E1.2

Accessories

Ekip trip unit accessories

All accessories are automatically recognized by the Ekip units without the need for any specific configuration. Based on the installation method and connection of the trip units, the electronic accessories can be divided into:

Installation	Modules	Highlights
Terminal box	Cartridge modules: Ekip Com Ekip Link Ekip 2K Ekip Supply Ekip Synchrocheck	<ul style="list-style-type: none"> - The Ekip Supply module enables the trip units to be supplied with a wide range of control voltages - The Ekip Supply module must be present for the other modules to be used - The Ekip Supply module has a dedicated position in the installation area in the terminal box; the other modules can be installed as desired in the positions available - When fitted with the Ekip Supply module, up to 2 additional modules can be installed on E1.2, and up to 3 on E2.2, E4.2 and E6.2
Accessorizing area	Ekip LCD Ekip Com Actuator Ekip RTC Ekip AUP Ekip Measuring Ekip Signalling 4K Rating Plug Battery for Ekip	<ul style="list-style-type: none"> - These are installed in specific housings from the front of the circuit breaker - For all the trip units with a touch screen interface, an LCD version is available without any adjustment in the protection and measurements functions - Thanks to the optional modules Ekip RTC and Ekip AUP, all the Ekip trip units can acquire and monitor the ready to close state and the racked in/ test isolated/racked out position of the circuit breaker - The Ekip Signalling 4k module increases the remote signalling possibilities for E2.2, E4.2 and E6.2 and can be installed if the Ekip Supply module or another 24V auxiliary power supply is present
Ekip trip unit test port	Ekip T&P Ekip TT Ekip Bluetooth	<ul style="list-style-type: none"> - These can be connected to the front test port of the trip units even with the device in operation - Compatible with the SACE Tmax XT range
External	Ekip Multimeter Ekip Control Panel Ekip 10K External neutral sensor Homopolar toroid Differential toroid (IEC only)	<ul style="list-style-type: none"> - Ekip Multimeter can supply a 24V DC output to the trip unit it is connected to - Several Ekip units and / or Ekip Signalling 10K can be connected at the same time to the same Ekip trip unit - These are connected to the trip unit by the terminal box of the circuit breaker



Power supply

Ekip Supply Power Supply module

The Ekip Supply module supplies all Ekip trip units and modules present on the terminal box and of the circuit breaker with auxiliary power (in AC or DC) available in the switchgear. The module is mounted in the terminal box and permits the installation of the other advanced modules. It can be field installed at any time.

Two versions are available according to the control voltage available:

- Ekip Supply 110-240V AC/DC
- Ekip Supply 24-48V DC

Electrical diagram reference: figures 31, 32



Connectivity

The Ekip Com modules enable all SACE Emax 2 circuit breakers to be integrated in an industrial communication network for remote supervision and control of the circuit breaker. They are suitable for all distribution and generator protection versions of the Ekip Touch and Hi-Touch trip units.

Since they are mounted in the terminal box, communication can be maintained with withdrawable circuit breakers, even while in the racked out position.

Several Ekip Com modules can be installed at the same time, thereby enabling connection to communication systems that use different protocols.

The Ekip Com modules are supplied complete with auxiliary position contacts Ekip AUP and ready to close circuit breaker contacts Ekip RTC.

The Ekip Com modules for Modbus RTU, Profibus-DP and DeviceNet contain a terminating resistor and dip switch for optional activation to terminate the serial network or bus. The Profibus-DP module also contains a polarization resistor and dip switch for its activation. For industrial applications where superior reliability of the communication network is required, the Ekip Com R communication modules, installed together with the corresponding Ekip Com modules, guarantee redundant connection to the network.

The Ekip Com modules enable Ekip trip units to be connected to networks that use the following protocols:

Protocol	Ekip Com Module	Ekip Com Redundant Module
Modbus RTU	Ekip Com Modbus RS-485	Ekip Com R Modbus RS-485
Modbus TCP	Ekip Com Modbus TCP	Ekip com R Modbus TCP
Profibus-DP	Ekip Com Profibus	Ekip Com R Profibus
Profinet	Ekip Com Profinet	Ekip Com R Profinet
EtherNet / IP	Ekip Com EtherNet / IP	Ekip Com R EtherNet / IP
DeviceNet	Ekip Com DeviceNet	Ekip Com R DeviceNet
IEC61850	Ekip Com IEC61850	Ekip Com R IEC61850

Electrical diagram reference: figures from 51 to 57. Redundant version from 61 to 66.

Accessories

Ekip trip unit accessories



Ekip Link module

The Ekip Link module enables a SACE Emax 2 circuit breaker to be connected to the ABB communication system for locally supervising switchgear by means of the Ekip Control Panel and to act as Power Controller. It is suitable for all Ekip trip units and can be factory or field installed in the circuit breaker terminal box, even when Ekip Com communication modules are present. In this way, it is possible to have both local supervision of the switchgear by means of the Ekip Control Panel and supervision of the electrical system by means of the Ekip Com modules connected to the communication network.

The Ekip Link modules are supplied complete with auxiliary position contacts Ekip AUP and ready to close circuit breaker contacts Ekip RTC.

Electrical diagram reference: figure 58

5



Ekip Com Actuator module

The Ekip Com Actuator module enables the SACE Emax 2 circuit breakers to be opened and closed remotely.

The Ekip com Actuator is optional and can be ordered for all Ekip trip units equipped with Ekip Com or Ekip Link modules; it is installed on the front of the circuit breaker in the right-hand accessories area.

Electrical diagram reference: figure 76, 78



Ekip Bluetooth wireless communication unit

Ekip Bluetooth permits remote connection with the trip unit by portable PC, tablet or smart phone on which Ekip Connect software has been installed. The device is connected to the front test port found on all Ekip trip units of SACE Emax 2 and SACE Tmax XT circuit breakers and supplies power by means of a rechargeable Li-ion battery.

Signalling

Ekip 2K Signalling modules

The Ekip 2K Signalling modules supply two input and two output contacts for control and remote signalling of alarms and circuit breaker trips. They can be programmed from the trip unit's display or through the Ekip Connect software. Furthermore, when using Ekip Connect, combinations of events can be freely configured. They are suitable for all distribution and generator protection versions of the Ekip Touch and Hi-Touch trip units.

Three versions of the Ekip 2K Signalling modules are available: Ekip 2K-1, Ekip 2K-2, Ekip 2K-3. In this way, a maximum of three modules for E2.2, E4.2, E6.2, and two for E1.2 can be installed at the same time.

Electrical diagram reference: figures 41, 42, 43



Ekip 4K signalling module

The Ekip 4K Signalling module, available for E2.2, E4.2 and E6.2, supplies four input contacts and four output contacts for control and remote signalling. It can be programmed from the trip unit's display or through the Ekip Connect software. Furthermore, when using Ekip Connect, combinations of events can be freely configured.

It is installed in the housing provided in the front left of distribution and generator protection versions of the Ekip Touch and Hi-Touch trip units, without having to remove the trip unit itself and is an alternative to the AUX 6Q (6 Form C) auxiliary contacts unit..

Electrical diagram reference: figure 2



Ekip 10K signalling unit

Ekip 10K Signalling is an external signalling unit designed for DIN rail installation for SACE Emax 2 automatic circuit breakers. The unit provides ten contacts for electrical signalling of timing and tripping of protection devices.

If connected via the Ekip Connect software, the contacts can be freely configured in association with any event and alarm or combination of both.

Several Ekip 10K Signalling (max 4) can be installed at the same time on the same Ekip trip unit. The Ekip 10K Signalling module can be powered either by direct or alternating current and can be connected to Ekip Touch and Hi-Touch trip units via internal bus or Ekip Link modules.

Electrical diagram reference: figure 103



Accessories

Ekip trip unit accessories

5

Characteristics of output contacts		Number of contacts		
Type	Monostable	Ekip 2K	Ekip 4K	Ekip 10K
Maximum switching power (resistive load)	1250VA			
Maximum switching voltage	150V DC / 250V AC			
Maximum switching current		2 output + 2 input	4 output + 4 input	10 output + 11 input
30V DC	2A			
50V DC	0.8A			
150V DC	0.2A			
250V AC	4A			
Contact/coil insulation	2000 Vrms (1min @50Hz)			

Ekip 10K signalling unit power supply

Auxiliary supply	24-48V DC, 110-240V AC/DC
Voltage range	21.5-53V DC, 105-265V AC/DC
Rated power	8W



Signalling contacts for Ekip trip units (Ekip RTC and Ekip AUP)

Ekip trip units can acquire the status of circuit breaker ready to close (RTC) and the racked in, test, or racked out position through the optional signalling contacts Ekip RTC and Ekip AUP.

These contacts, housed in the accessories area of the circuit breakers, are available with Ekip Dip, Ekip Touch and Ekip Hi-Touch.

Ekip Com communication modules and Ekip Link modules are always supplied with Ekip AUP and Ekip RTC contacts.



Measurement and protection

Ekip Measuring module

The Ekip Measuring module enables the trip unit to measure the phase and neutral voltages, powers and energy.

The Ekip Measuring module is installed on the front, right housing of the distribution protection versions of the Ekip Touch trip units, without having to remove the trip unit itself. The voltage connections are installed by default on the lower terminals, but can be altered to the upper terminals on request.

The measuring module requires no external connection since it is connected internally to the lower or upper terminals of Emax 2. If necessary, the voltage outlet connection can be moved outside the circuit breaker by using voltmetric transformers and the alternative connection positioned in the terminal box. The use of external connections is obligatory for rated voltages that are higher than 690V. The module must be disconnected for dielectric strength tests on the main busbars.

Electrical diagram reference: figures 20, 21, 22, 23



1SDC200549F001

Ekip Measuring Pro module

The module has the same connection and installation characteristics as the Ekip Measuring module. In addition, the Ekip Measuring Pro version offers:

- Protection features for voltage and power values
- Ekip trip unit power supply from busbar voltage (for line voltages greater than 85V)
- LED signalling when voltage is detected on the main busbars.

The Ekip Measurement Pro module comes standard with the Ekip Hi-Touch, Ekip G Touch and Ekip G-Hi Touch trip units.

Electrical diagram reference: figures 20, 21, 22, 23



1SDC200551F001

Ekip Synchrocheck

This module enables the control of the synchronism condition when placing two lines in parallel. The module can be used with distribution and generator protection versions of the Ekip Touch and Hi-Touch trip units equipped with the Ekip Measuring Pro module.

Ekip Synchrocheck measures the voltages from two phases of one line through an external transformer and compares them to the measured voltages at the breaker utilizing the Ekip Measuring Pro Module. An output contact is available, which is activated upon reaching synchronism, and enables the circuit breaker to be closed by means of wiring with the closing coil.

Characteristics of output contacts		Number of contacts
Type	Monostable	Ekip Synchrocheck
Maximum switching power (resistive load)	120W / 1250VA	1 output
Maximum switching voltage	150V DC / 250V AC	
Maximum switching current		
30V DC	2A	
50V DC	0.8A	
150V DC	0.2A	
250V AC	4A	
Contact/coil insulation	2000 Vrms (1min @50Hz)	

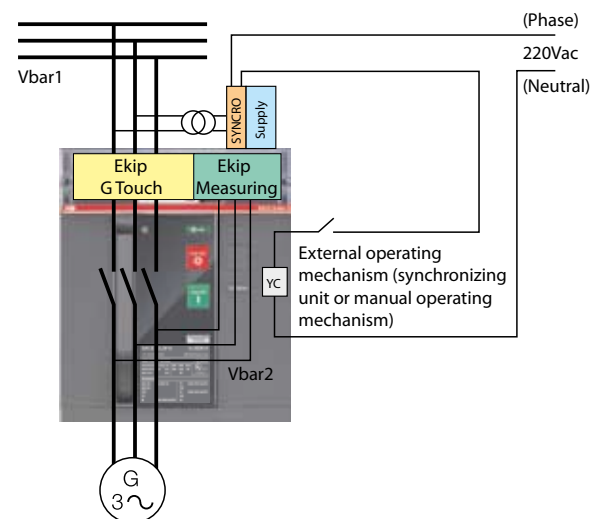

Electrical diagram reference: figure 48

Accessories

Ekip trip unit accessories



Ekip LCD display interface

For installations in particularly aggressive environments, such as low temperatures, high humidity or the presence of dust or chemical agents, the Ekip protection trip units can be requested with an LCD black and white display interface with pushbuttons for navigation. This version guarantees excellent immunity by integrating all functions, with regard to protection devices, measuring devices and the possibility of introducing the same accessories available on the color touch screen versions.



Rating Plug

The rating plugs are field interchangeable from the front on all trip units and enable the protection thresholds to be adjusted according to the actual rated current of the system. This function is particularly advantageous in installations that may require future expansion or in cases in which the power supplied needs to be limited temporarily (e.g. mobile Gen Set). The Overload (L) protection function can be disabled at any time by using an L OFF version of the rating plug. The L OFF versions of the rating plugs are IEC rated only.

Circuit-breaker	Rating plugs available (both in standard and L OFF ¹⁾ versions)
E1.2	400-600 ²⁾ -630 ¹⁾ -800-1000-1200 ²⁾ -1250 ¹⁾ -1600 ¹⁾
E1.2 250	100-200-250
E2.2	400-600 ²⁾ -630 ¹⁾ -800-1000-1200 ²⁾ -1250 ¹⁾ -1600-2000-2500 ¹⁾
E2.2 250	100-200-250
E4.2	400-600 ²⁾ -630 ¹⁾ -800-1000-1200 ²⁾ -1250 ¹⁾ -1600-2000-2500-3000 ²⁾ -3200-3600 ²⁾ -4000 ¹⁾
E6.2	400-600 ²⁾ -630 ¹⁾ -800-1000-1200 ²⁾ -1250 ¹⁾ -1600-2000-2500-3000 ²⁾ -3200-3600 ²⁾ -4000-5000-6000 ²⁾ -6300 ¹⁾

1) IEC rated; 2) UL rated (no L OFF version available)

Special rating plugs are also available for differential protection (residual current) against earthing faults in combination with a suitable toroid to be installed externally. These rating plugs are IEC rated only.

Circuit-breaker	Rating plug available for Rc protection (IEC rated)
E1.2	400-630-800-1250
E1.2 250	100-200-250
E2.2	400-630-800-1250-2000
E2.2 250	100-200-250
E4.2	400-630-800-1250-2000-3200-4000



Current sensor for external neutral

Intended for use with three-pole circuit breakers; it enables protection of the neutral phase to be achieved through connection to the Ekip trip unit. It is supplied on request.

Electrical diagram reference: figure 27



Homopolar toroid for the earthing conductor of main power supply (transformer star center sensor input)

The distribution and generator protection versions of the Ekip Touch and Hi-Touch trip units can be used with an external toroid positioned, for example, on the conductor that connects the star centre of the MV/LV transformer to earth (homopolar transformer): in this case, the earth protection is called Source Ground Return. There are four sizes of the toroid: 100A, 250A, 400A, 800A. The homopolar toroid is an alternative to the toroid for differential protection.

Electrical diagram reference: figure 25



Toroid for differential protection (Rc residual current protection sensor input) (IEC only)

Connected to the Ekip Touch LSIG and Hi-Touch LSIG trip units equipped with a rating plug for differential protection, this toroid enables earth fault currents of 3...30A to be monitored. To be installed on the busbar system, it is an alternative to the homopolar toroid.

Electrical diagram reference: figure 24

Accessories

Ekip trip unit accessories



Displaying and supervision

Ekip Multimeter Display on the front of switchgear

Ekip Multimeter is a display unit to be installed on the front of the switchgear for SACE Emax 2 circuit breakers equipped with Ekip electronic trip units. The device, 3.78"x3.78" / 96mmx96mm in size, is equipped with a large touch screen display and enables measurements to be displayed with the same levels of precision as the trip unit itself. If connected to trip units with a display, Ekip Multimeter enables the adjustment of parameters and protection thresholds.

Up to 4 Ekip Multimeter devices can be connected at the same time to the same Ekip protection trip unit to display currents, voltage, powers and energy.

Ekip Multimeter can be powered either in direct current (24-48V DC or 110-240V DC) or in alternating current (110-240V AC). It is equipped with a 24V DC output that supplies the trip unit to which it is connected.

Power supply	24-48V DC, 110-240V AC/DC
Tolerance	21.5-53V DC, 105-265V AC/DC
Rated Power	8W



Ekip Control Panel on the front of switchgear

The Ekip Control Panel enables SACE Emax 2 circuit breakers connected to the Ekip Link system to be controlled and monitored. It offers a 15" color LCD touchscreen display in a package that is 15.08"/383mm wide, 12.09"/307mm high and 3.09"/78.5mm deep.

The panel is supplied already equipped with supervision software and requires no programming. Ekip Control Panel requires a 24V DC power supply and is equipped with:

- 2 RJ45 EtherNet ports for connection to the Ekip Link system and to the local network for remote control via web server option
- 1 RS485 serial port for integration of the Modbus network if it is to be used with circuit breakers of the Tmax series
- 4 USB ports for downloading data.



1SDC200689F001

Testing and programming

Ekip TT testing and power supply unit (battery pack)

Ekip TT is a device that allows you to verify that the circuit breaker trip mechanism is functioning correctly (trip test).

It also allows a trip unit not provided with auxiliary power supply to be supplied with power so that the last protection device tripped can be displayed directly on the screen or by the lighting up of corresponding LEDs.

The device can be connected to the front test port of any Ekip trip unit of SACE Emax 2; it is supplied as standard with the versions for distribution and generator protection of the Ekip Touch, Hi-Touch trip units to set protection functions.



1SDC200561F001

Ekip T&P testing kit

Ekip T&P is a kit that includes different components for programming and testing the electronic protection trip units.

The kit includes:

- Ekip T&P unit;
- Ekip TT unit;
- adaptors for Emax and Tmax trip units;
- USB cable to connect the T&P unit to the Ekip trip units;
- installation CD for Ekip Connect and Ekip T&P interface software.

The Ekip T&P unit easily connects from your PC (via USB) to the trip unit (via mini USB) with the cable provided.

The Ekip T&P unit can perform simple manual or automatic tests on the trip unit functions. The Ekip T&P will also provide the ability to conduct more advanced function testing that allows the addition of harmonics and the shifting of phases to more accurately represent the real conditions of an application. Thus, leading to more concise protection function parameters that may be required for critical applications. It can also generate a test report as well as help you to monitor maintenance schedules.



1SDC200561F001

Ekip Programming Module

The Ekip Programming module is used for programming Ekip trip units via USB to a PC using the Ekip Connect software that can be downloaded on-line. This can be useful for uploading/downloading entire sets of parameters for multiple breakers both for set-up as well as for maintenance (for periodic cataloging breaker parameters in case of a catastrophic situation).

Accessories

Spare parts

Spare parts

The following original and guaranteed spare parts are available:

- Front shield and lateral covers
- Opening solenoid for Ekip protection trip unit
- Arc chamber
- Complete pole
- Operating mechanism and closing springs
- Loading lever for closing springs
- Racking out lever
- Racking out handle and plates
- Jaw isolating contact for the cradle of a drawout circuit breaker
- Shutters for the cradles
- Trip units - current transformers wires
- Transparent protection for trip unit
- Mainboard for protection trip units
- Terminal box and sliding contacts
- Grease and oil.

For further details, please refer to the ABB SACE Spare Parts Catalog.

Circuit breaker	6/2
Sizes	6/3
Versions	6/4
Poles	6/5
Terminals	6/6
Degree of protection	6/7
Power losses	6/7
Temperature derating	6/8

Installation environment

Temperature	6/9
Environmental conditions	6/9
Vibration	6/9
Electromagnetic compatibility	6/9

Installation in switchgear

	6/10
Position	6/11
Power supply	6/11
Insulation distances and connection	6/11
Busbar types	6/13
Busbar recommendation	6/13
Bars connection	6/13
Auxiliary connection	6/13
Accessories	6/14

Installation

Circuit breaker

The new SACE Emax 2 family maintains the traditional characteristics of strength and reliability that have always distinguished ABB SACE power circuit breakers.

The new SACE Emax 2 circuit breakers, available in four sizes, are extremely compact. With reduced depths and heights, combined with rationalized widths, they provide the answer to the most stringent installation requirements.

Safety is guaranteed because of double insulation of the live parts and total segregation of the phases. Furthermore, the new functional design of SACE Emax2 circuit breakers has been developed with the purpose of improving installation operations and the use of the devices and accessories; making them simple, intuitive and safe.

Distinctive characteristics	Benefits
<ul style="list-style-type: none"> - Ekip protection trip units are interchangeable from front of circuit breaker - Rapid configuration of the Ekip trip units - Electronic modules can be installed on terminal box without removing the electronic trip units and protection shield - Electrical plug-in accessories can be installed from the front of circuit breaker 	Reduced times during the stages of: <ul style="list-style-type: none"> - installation - wiring - configuration - commissioning - maintenance
Simplicity of use and safety <ul style="list-style-type: none"> - New push-in terminal box allows rapid auxiliary connections - Horizontal or vertical rear connections can be modified on-site by turning 90° - Accessorizing logic common to the entire family of circuit breakers - Accessory cabinet and terminal box are stamped with accessory codes for easy identification - Accessories area is separated functionally from the safety area - Mechanical safety locks in open position are active when the shield is removed - Guided racking in and out of the mobile part 	Increased level of safety

Sizes

SACE Emax 2 circuit breakers, available in 4 sizes up to 6000A, provide:

- **Versatility**, where installation space is a critical and influential factor, such as naval applications, wind turbine towers or switchgear
- **Opportunities**, optimization of the switchgear dimensions results in a potential reduction in materials used.

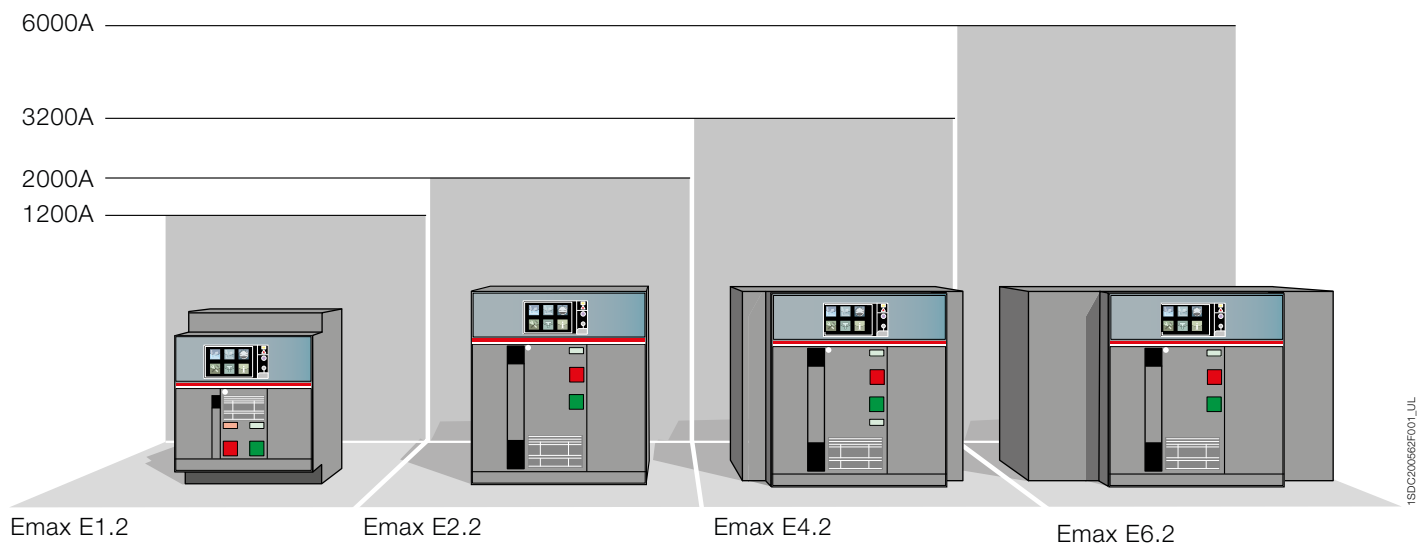

Installation

Circuit breaker

Versions

SACE Emax 2 circuit breakers are available in both fixed and drawout versions. The drawout version is recommended in applications in which service continuity is a fundamental requirement. Replacement of the moving part with a new device does not require any intervention on power connections or on auxiliary connections, thus permitting reset in the shortest time possible.

The fixed version, which is connected directly to power system through the circuit breaker terminals, is recommended in applications where the need for space means that compact products are required without compromising the performance and possibility of fitting accessories.

6

Fixed



Drawout



1. Moving part
2. Sliding contacts
3. Cradle
4. Terminal box
5. Racking out mechanism
6. Racking out guide rails
7. Pushbuttons
8. Data label and accessories

Poles

SACE Emax 2 circuit breakers are available in three-pole and four-pole versions and can be used in all types of distribution systems. Furthermore, with the possibility of connecting the external current sensor, three-pole circuit breakers can be used efficiently even in systems in which the neutral conductor cannot be isolated.

The four-pole circuit breakers E1.2, E2.2 and E4.2 are always provided with a full-size neutral pole with rated uninterrupted current-carrying capacity identical to the phase poles. The E6.2 circuit breakers, due to their modular construction, are available with the neutral set at 50% - normal supply – and with a full-size neutral, so that the customer does not need to oversize the neutral unless it is strictly necessary.

The standard supplied circuit breakers are suitable for connection of phases in the sequence L1, L2, L3 for three-pole circuit breakers or N, L1, L2 and L3 for four-pole circuit breakers with neutral on the left. A special optional kit enables the position of the circuit breaker neutral to be changed to the right, making the sequence L1,L2,L3,N available.

Circuit breaker	Standard version		Optional version with neutral on the right
	Three-pole	Four-pole	Four-pole
Emax E1.2			
Emax E2.2			
Emax E4.2			
Emax E6.2			

Installation

Circuit breaker

Terminals

The integration of the circuit breaker into an electrical system is simplified because of the connection terminals of the circuit breakers. The silver-plated copper terminals are designed to assist installation of connecting bars according to the change in the rated capacity of the circuit breaker. Each terminal has been created to the standard width of busbar for that amperage and is equipped with one, two or three terminal stabs for easy connection to multiple bus runs that may be required for the application. For particular installation requirements, the circuit breakers can be equipped with different combinations of terminals for the upper and lower part.

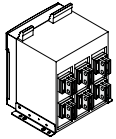
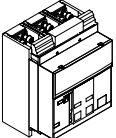
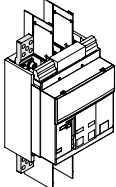
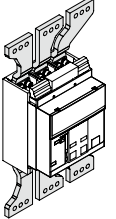
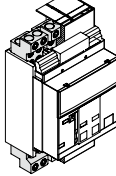
Type	Abbreviation		E1.2	E2.2	E4.2	E6.2
Rear adjustable terminal ⁽¹⁾	HR VR		F, W	F, W	F, W	F, W
Front terminal	F		F	F, W	F, W	F, W
Extended front terminal	EF		F, W			
Front spread terminal	ES		F, W			
Terminal for cable FcCuAl 4x500kcmil / 240mm ²	Fc CuAl		F			

(1) The rear adjustable terminals are supplied as standard in the HR-HR configuration, with exception for E4.2 L version, E4.2 3200A and E6.2 6000A in which they are supplied in VR - VR configuration.

Degree of protection

SACE Emax 2 circuit breakers guarantee the following degrees of protection:

- IP20 for circuit breakers in fixed or drawout versions, excluding the terminals.
- IP30 for the front parts of the circuit breaker when installed in switchgear with the IP30 flange mounted on the door.
- IP54 for circuit breakers equipped with optional IP54 transparent flange fixed on the door on the front of the switchgear.

Power losses

To guarantee the performance of the electrical switchgear in terms of rated uninterrupted current-carrying capacity, the design of the electrical switchgear must take into consideration the power losses by the circuit breaker and by live parts installed.

The values given in the table refer to total power for three and four pole circuit breakers with balanced loads with a current flow equal to rated uninterrupted current "I_u" at 60Hz.

Circuit breaker type		[W]/[A]	250	400	800	1200	1600	2000	2500	3200	3600	4000	5000
Fixed	E1.2 B-A, N-A, S-A	W	7	17	59	125							
	E2.2 B-A, N-A, S-A	W		15	48	100	170						
	E2.2 H-A, V-A / E2.2 2000A B-A, N-A, S-A	W		15	48	99	167	250					
	E4.2 S-A, H-A, V-A	W			44	86	143	211	310				
	E4.2 L-A / E4.2 3200A S-A, H-A, V-A	W			42	81	132	193	280	445			
	E6.2 H-A, V-A	W								323	395	476	700
	E6.2 L-A	W										476	700
Drawout	E1.2 B-A, N-A, S-A	W	14	35	118	250							
	E2.2 B-A, N-A, S-A	W		22	73	152	260						
	E2.2 H-A, V-A / E2.2 2000A B-A, N-A, S-A	W		22	68	138	233	350					
	E4.2 S-A, H-A, V-A	W			58	114	189	279	410				
	E4.2 L-A / E4.2 3200A S-A, H-A, V-A	W			49	111	181	264	384	610			
	E6.2 H-A, V-A	W								438	536	646	950
	E6.2 L-A	W										646	950

Installation

Circuit breaker

Temperature derating

Under certain installation conditions, the circuit breakers can operate at higher temperatures than the reference temperature of 40°C (104°F). In this case the current-carrying capacity of the circuit breaker may be lower than the rated current-carrying capacity at the reference temperature; therefore the derating coefficients shown in the table must be applied. Percentage values refer to drawout and fixed circuit breakers.

Emax 2 E1.2		Temperature [°C/°F]						
		<40/104	45/113	50/122	55/131	60/140	65/149	70/158
E1.2	250	100%	100%	100%	100%	100%	100%	100%
E1.2	400	100%	100%	100%	100%	100%	100%	100%
E1.2	800	100%	100%	100%	100%	100%	100%	100%
E1.2	1200	100%	98%	96%	95%	92%	90%	89%

Emax 2 E2.2		Temperature [°C/°F]						
		<40/104	45/113	50/122	55/131	60/140	65/149	70/158
E2.2	250	100%	100%	100%	100%	100%	100%	100%
E2.2	400	100%	100%	100%	100%	100%	100%	100%
E2.2	800	100%	100%	100%	100%	100%	100%	100%
E2.2	1200	100%	100%	100%	100%	100%	100%	100%
E2.2	1600	100%	100%	98%	95%	93%	91%	89%
E2.2	2000	100%	100%	97%	94%	92%	90%	88%

Emax 2 E4.2		Temperature [°C/°F]						
		<40/104	45/113	50/122	55/131	60/140	65/149	70/158
E4.2	800	100%	100%	100%	100%	100%	100%	100%
E4.2	1600	100%	100%	100%	100%	100%	100%	100%
E4.2	2000	100%	100%	100%	100%	100%	100%	100%
E4.2	2500	100%	98%	96%	94%	92%	90%	88%
E4.2	3200	Consult factory						

Emax 2 E6.2		Temperature [°C/°F]						
		<40/104	45/113	50/122	55/131	60/140	65/149	70/158
E6.2	4000	100%	100%	100%	100%	100%	100%	100%
E6.2	5000	100%	98%	96%	93%	91%	89%	87%
E6.2	6000	Consult factory						

Installation

Installation environment

SACE Emax 2 circuit breakers have been designed and tested in accordance with major international standards to manage with the electrical plant with maximum reliability. The installation requirements prescribed by the international standards are listed below. In addition, ABB provides instructions for the use of circuit breakers in nonstandard environments, for example personalized maintenance programs or installation solutions aimed at increasing performances and extending the lifecycle of the circuit breaker.

Temperature

SACE Emax2 circuit breakers can operate in the following environmental conditions:

	Temperature		
	Operating	Active Display	Storage
Emax 2 with Ekip DIP	-25°C ... +70°C / -13°F...+158°F	-	-40°C ... +70°C / -40°F...+158°F
Emax 2 with Ekip Touch, Hi-Touch	-25°C ... +70°C / -13°F...+158°F	-20°C ... +70°C / -4°F...+158°F	-30°C ... +70°C / -22°F...+158°F
Emax 2 with LCD	-25°C ... +70°C / -13°F...+158°F	-25°C ... +70°C / -13°F...+158°F	-40°C ... +70°C / -40°F...+158°F
Emax 2 swith-disconnectors	-25°C ... +70°C / -13°F...+158°F	-	-40°C ... +70°C / -40°F...+158°F

Environmental conditions

The devices can be installed in industrial environments with pollution level 3, IEC 60947. SACE Emax 2 circuit breakers also comply with:

- IEC60721-3-6 class 6C3
- IEC60721-3-3 class 3C2

Altitude

SACE Emax 2 air circuit breakers do not undergo changes in rated performance up to 6600 feet. Beyond this altitude, the properties of the atmosphere in terms of composition, dielectric capacitance, cooling power and pressure can vary and, therefore, the performance of the circuit breakers is subject to derating, which can be measured by means of the variation in maximum rated service voltage and rated uninterrupted current.

Altitude	[ft]	6600	9900	13200	16500
	[m]	2000	3000	4000	5000
Rated service voltage - Ue	[V]	600	600	500	440
Rated current	[% In]	100	98	93	90

Vibration

The circuit breakers have been tested according to:

- IEC60068-2-6
 - From 1 to 13 Hz with amplitude 1mm
 - From 13 to 100 Hz with constant acceleration 0.7g
- IEC60721-3-1
 - Storage: 1M3
- IEC60721-3-2
 - Transport: 2M2
- IEC60721-3-3
 - Operational conditions: 3M2
- Shipping registers or certifications

Electromagnetic compatibility

The use of specific devices in industrial installations may cause electromagnetic interference in the electrical system. SACE Emax 2 circuit breakers have been developed and tested for electromagnetic compatibility in accordance with IEC 60947-2; Appendices J and F, ANSI C37.90.1 and C37.90.2.

Installation

Installation in switchgear

Due to the four construction sizes and the reduced insulation distances required, SACE Emax 2 circuit breakers optimize the installation spaces of the compartments of electrical switchgear, thereby providing a rational solution to application needs.

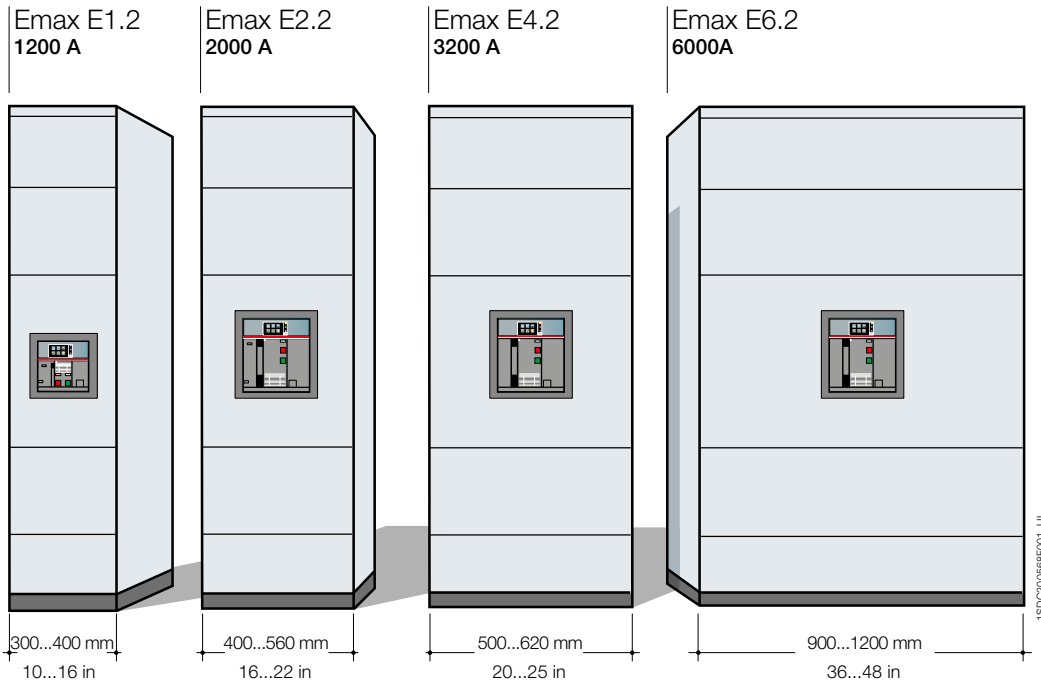

6

SACE Emax 2 circuit breakers enable the design of electrical switchgear to be improved, allowing optimization in terms of performance, and also in terms of materials used.

- **Copper:** because of the possibility of developing compact units, the length of the distribution system / busbar can be minimized.
- **Metal frame and structure:** reduced volume means less metal is used for panels and internal structures.
- **Space:** the optimization of the individual units benefits the entire switchgear, which is more compact and can therefore be installed taking up less space.

Traditional circuit breaker 3p lu 2000A

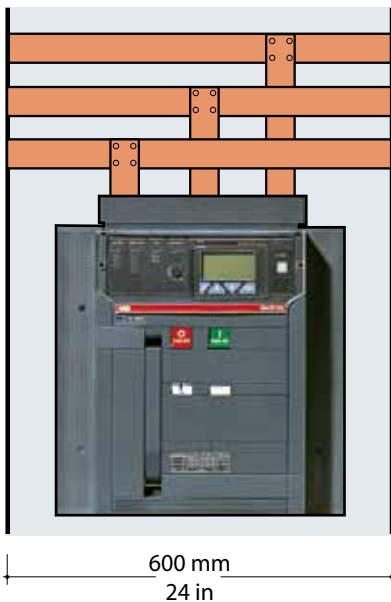

Emax E2.2 3p lu 2000A

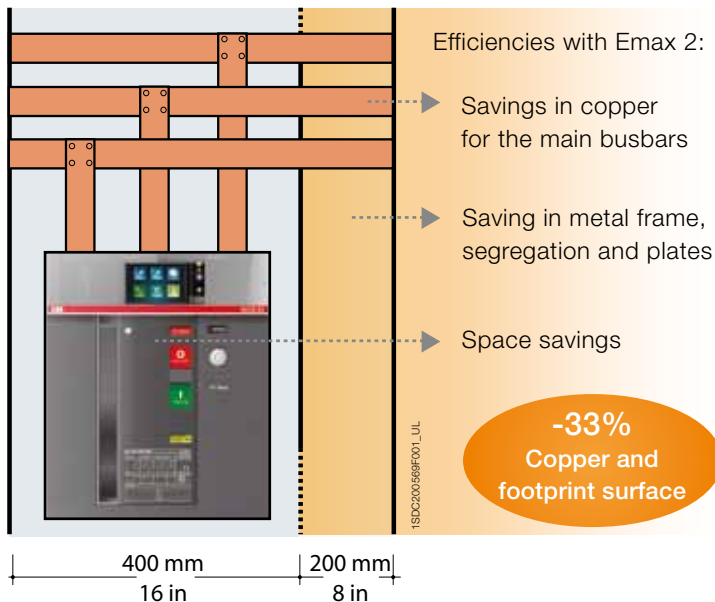

Installation

Installation in switchgear

Position

All SACE Emax 2 circuit breakers can be floor mounted in a vertical position inside the switchgear compartment. The E1.2 circuit breaker can also be installed in a horizontal position and wall mounted. Conveniently, the screens of the Ekip Touch and Hi-Touch versions rotate to a horizontal view for key data when the E1.2 is installed horizontally.

Power supply

The Emax 2 circuit breakers can be supplied, indifferently, from either the upper or lower terminals. In the event a measurement module is present, in order to make use of all information when the circuit breaker is in the open position, the voltage sockets must be installed on the power supply side.



1SDC200579F001

Insulation distances and connection

The circuit breakers can be connected to the main power system using the most common configurations and dimensions of copper bars. Installation of live parts must ensure:

– **Minimum insulation distances between the phases**

The use of phase barriers is recommended for fixed version circuit breakers used in voltages over 480V.

– **Minimum enclosure dimensions**

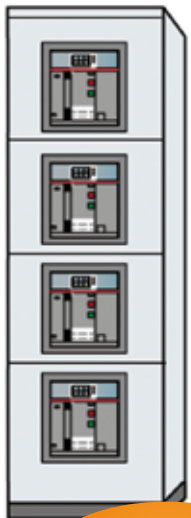

1SDC200579F001_LUL

Up to four Emax 2 at 100kA in one column!

Fixed circuit breakers

		Width		C - Height	D - Depth
		3p	4P		
E1.2	[mm]	250	322	382.5	130
	[inch]	9.84	12.67	15.05	5.11
E2.2	[mm]	400	490	500	221
	[inch]	15.74	19.29	19.68	8.7
E4.2	[mm]	500	620	500	221
	[inch]	19.68	24.41	19.68	8.7
E6.2	[mm]	900	1020	500	221
	[inch]	35.43	40.16	19.68	8.7
E6.2/f	[mm]	-	1200	500	221
	[inch]	-	47.24	19.68	8.7

Drawout circuit breakers

		Width		C - Height	D - Depth
		3p	4P		
E1.2	[mm]	280	350	440	252
	[inch]	11.02	13.77	17.32	9.92
E2.2	[mm]	400	490	440	355
	[inch]	15.74	19.29	17.32	13.97
E4.2	[mm]	500	620	440	355
	[inch]	19.68	24.41	17.32	13.97
E6.2	[mm]	900	1020	440	355
	[inch]	35.43	40.16	17.32	13.97
E6.2/f	[mm]	-	1200	440	355
	[inch]	-	47.24	17.32	13.97

- For Emax 2 "X" versions ask to ABB.

Installation

Installation in switchgear

6

– Anchorage plates

The electrodynamic force released during a short-circuit can cause high levels of mechanical stress to the devices and structures of the switchgear. To minimize this, fastening plates must be positioned near the circuit breaker terminals.

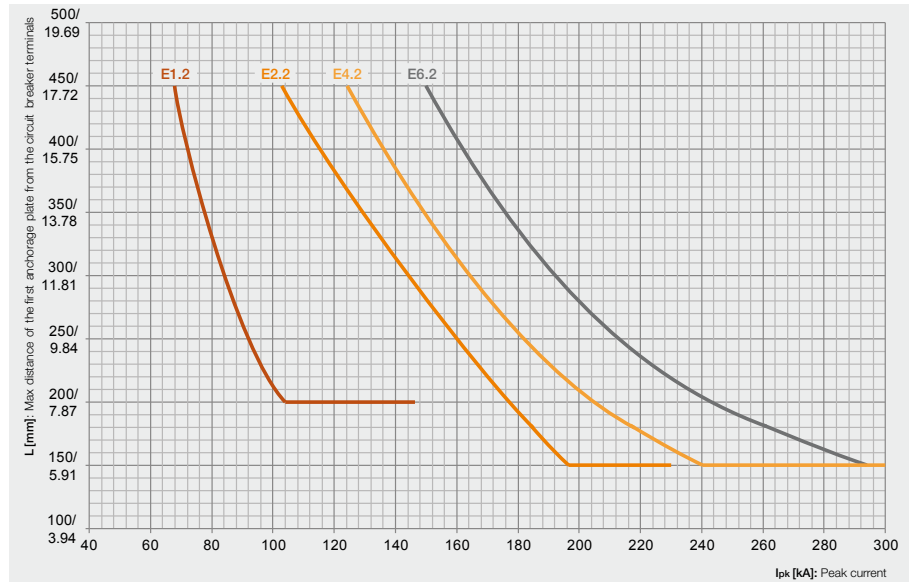

– Tightening torques

The following table indicates the values required for connecting the circuit breaker terminal and the connecting bars.

Terminals	E1.2	E2.2 / E4.2 / E6.2
Adjustable HR/VR rear	40 Nm / 354.03 lb-in	70 Nm / 619.55 lb-in
Spread rear	40 Nm / 354.03 lb-in	–
Front	40 Nm / 354.03 lb-in	70 Nm / 619.55 lb-in
Extended front	40 Nm / 354.03 lb-in	–
Spread front	70 Nm / 619.55 lb-in	–
Front for cables	43 Nm / 380.58 lb-in	–

– Segregation and separator plates

The rear part of the circuit breaker has been designed with specific slots in which insulating walls can be housed to facilitate segregation of live parts. In addition, phase barriers are available as an optional accessory for E1.2.

Earthing connection

To achieve continuity and equal potential of earthing between the Emax 2 circuit breaker and the protection circuit of the switchgear, customers can use either option below:

- Connect the Emax 2 fixed circuit breaker or the cradle of the drawout circuit breaker to the protective circuit by means of a cable with suitable cross-sectional area to fulfil the switchgear requirements.
- If the continuity of the circuit breaker frame with the switchboard earthing is guaranteed by the metal contact (support) between the circuit breaker and the metal structure of the switchboard (which is a part of the protective circuit) no connection is necessary (provided that no panels of insulating material are interposed between the circuit breaker and the metal frame of the switchboard). Emax E1.2, fixed version, does not require any earthing connection.

Busbar types

The circuit breakers, via the terminals, can be connected to the main distribution system by busbars of different types: copper, silver-plated copper and tinned aluminium when the main distribution system is made of aluminium.

The circuit breakers can be connected directly with copper or aluminium cables in the case of E1.2 circuit breakers, or indirectly by cable-carrying bars in the case of E2.2, E4.2 and E6.2.

Bars recommendation

Frame	lu	Vertical			Horizontal		
		Qty	Size (in)	Size (mm)	Qty	Size (in)	Size (mm)
E1.2	800	1	1/4 x 3	6.4 x 76.2	2	1/4 x 2	6.4 x 50.8
E1.2	1200	2	1/4 x 2	6.4 x 76.2	3	1/4 x 2	6.4 x 50.8
E2.2	1600	2	1/4 x 3	6.4 x 76.2	3	1/4 x 2.5	6.4 x 63.5
E2.2	1600	3	1/4 x 2	6.4 x 50.8	4	1/4 x 2	6.4 x 50.8
E2.2	2000	4	1/4 x 2	6.4 x 50.8	4	1/4 x 2.5	6.4 x 63.5
E4.2	2000	4	1/4 x 2	6.4 x 50.8	4	1/4 x 2.5	6.4 x 63.5
E4.2	2500	3	1/4 x 4	6.4 x 102	4	1/4 x 4	6.4 x 102
E4.2	3200	4	1/4 x 4	6.4 x 101	-	-	-
E6.2	4000	4	1/4 x 5	6.4 x 127	4	1/4 x 5	6.4 x 127
E6.2	5000	6	1/4 x 5	6.4 x 127	8	1/4 x 5	6.4 x 127

Note: The tables should be used solely as a general guideline for selecting products. Due to the extensive variety of switchgear construction shapes and conditions that can affect the behavior of the apparatus, the solution used must always be verified.



1SDC200691F001

Bars connection

The Emax 2 terminal design maximizes the thermal performance into the switchgear. Thanks to the busbar friendly, single to multiple stab design, it is possible to connect bars easily and smartly:

- a wide contact surface between terminals and bars improves the current carrying capacity;
- a spacing between stabs and multi bars increase the ventilation efficacy on E2.2, E4.2 and E6.2;
- a 1/4" spacing eliminates the need to bend bars and allows for an easier connection to the main busbars.

Auxiliary connection

The new terminal box uses spring clamp technology. All cables can be connected to each terminal without tools, guaranteeing time saving during the wiring activities.



Installation

Installation in switchgear

Accessories

SACE Emax 2 circuit breakers offer a wide range of accessories that improve safety levels for technicians working on the switchgear and circuit breakers. Furthermore, thanks to the different types of mechanical interlocks available, pre-determined coordination strategies can be achieved between the circuit breakers. In detail:

- Horizontal and vertical interlocks between circuit breakers
- Door lock with circuit breaker in closed position
- Switchgear door lock in racked in/out position
- Lock of racked out mechanism with door open
- Flange for switchgear door IP30 and IP54

For further accessory information, see chapter 5.

Dimensions

Fixed circuit breaker	7/2
E1.2	7/4
E2.2	7/8
E4.2	7/10
E6.2	7/13
Withdrawable circuit breaker	7/15
E1.2	7/17
E2.2	7/21
E4.2	7/21
E6.2	7/25

Dimensions

Fixed circuit breaker

E1.2

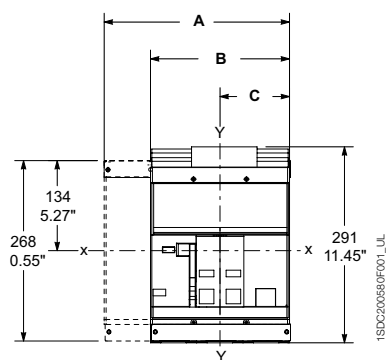

E2.2 - E4.2 - E6.2

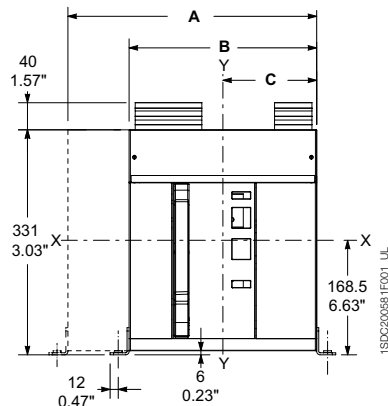

[mm/in]	A	B	C	
	4p	3p	3p	4p
E1.2	284/11.18	214/8.42	107/4.21	107/4.21
E2.2	366/14.40	276/10.86	138/5.43	138/5.43
E4.2	510/20.07	384/15.11	192/7.55	192/7.55
E6.2	888/34.96	762/30	318/12.42	444/17.48
E6.2/f	1014/39.92	-	-	444/17.48

7

Compartment door drilling

E1.2

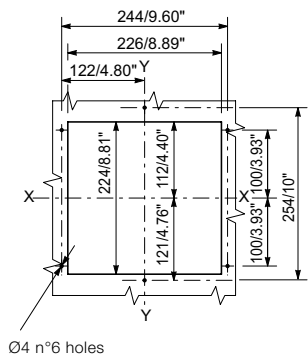

E2.2 - E4.2 - E6.2

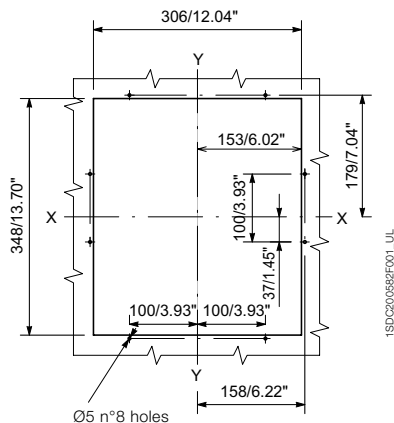

E1.2

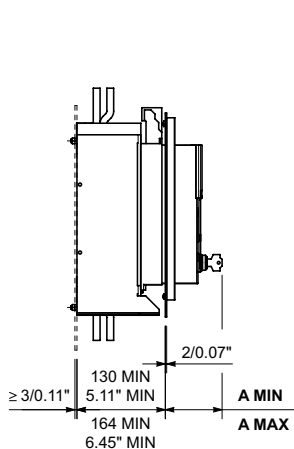

E2.2 - E4.2 - E6.2

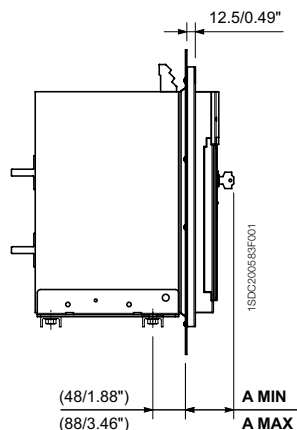

E1.2	Standard	Ronis/Profalux	Kirk	Castell
A MIN [mm/in]	49.5/ 1.94"	63.5/ 2.5"	63.5/ 2.5"	83.5/ 3.28"
A MAX [mm/in]	83.5/ 3.28"	97.5/ 3.83"	97.5/ 3.83"	117.5/ 4.62"

E2.2-E4.2-E6.2	Standard	Ronis/Profalux	Kirk	Castell
A MIN [mm/in]	29.5/ 1.16"	41.5/ 1.63"	46.5/ 1.83"	65/ 2.55"
A MAX [mm/in]	69.5/ 2.73"	81.5/ 3.20"	86.5/ 3.40"	105/ 4.13"

Dimensions of the compartment

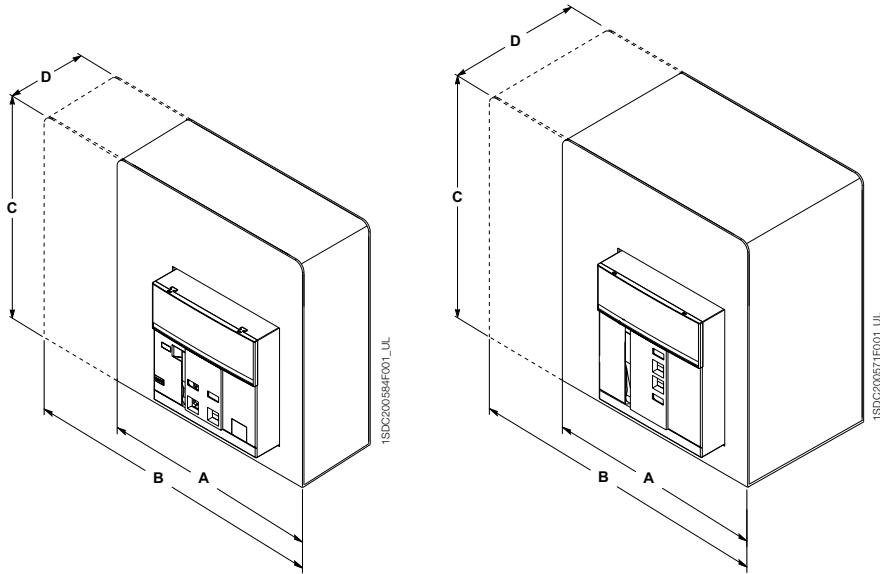

[mm/in]	A	B	C	D
	3p	4p		
E1.2	250/9.84	322/12.67	382.5/15.05	130/5.11
E2.2	400/15.74	490/19.29	500/19.68	221/8.70
E4.2	500/19.68	620/24.41	500/19.68	221/8.70
E6.2	900/35.43	1020/40.16	500/19.68	221/8.70
E6.2/f		1200/47.24	500/19.68	221/8.70

Floor fixing

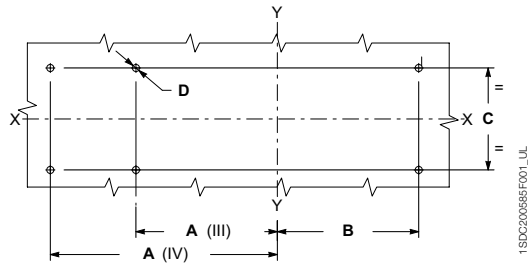

[mm/in]	A	B	C	D
	3p	4p		
E1.2	117/4.60	187/7.36	117/4.60	80/3.14
E2.2	154/6.06	244/9.60	154/6.06	150/5.90
E4.2	208/8.18	334/13.14	208/8.18	150/5.90
E6.2	460/18.11	460/18.11	334/13.14	150/5.90
E6.2/f	-	586/23.07	460/18.11	150/5.90

Wall fixing (only for E1.2)

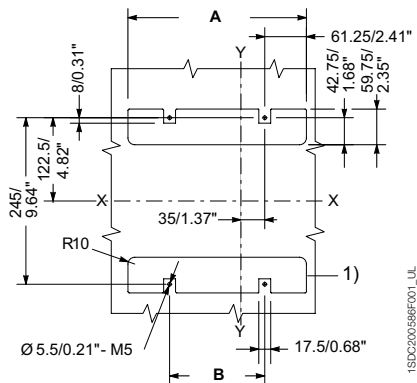

[mm/in]	3 p	4 p
A	192.5/7.57"	262.5/10.33"
B	70/2.75"	140/5.51"

1) for fixing with rear terminals

Earthing device E2.2 - E4.2 - E6.2

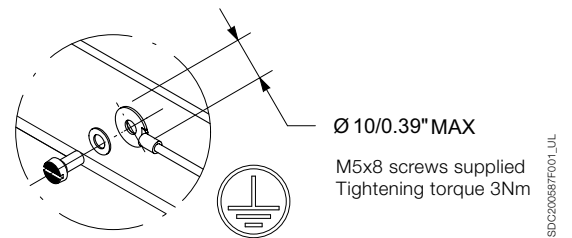

Dimensions

Fixed circuit breaker - E1.2

Front terminals – F

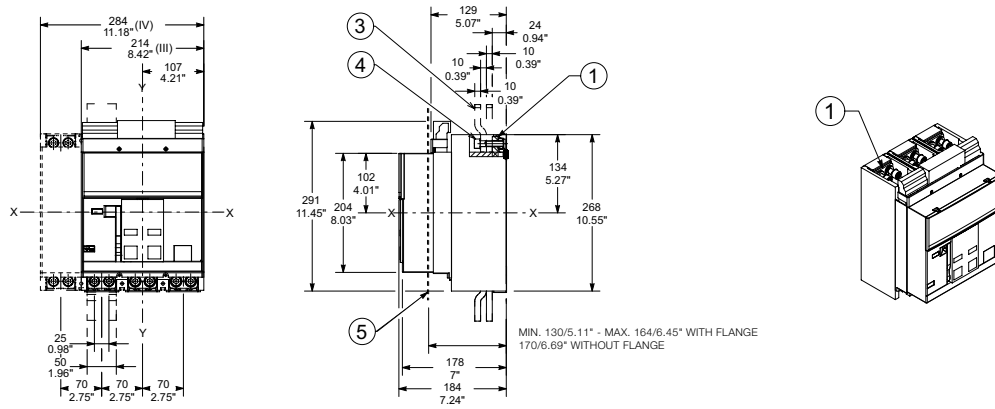

Extended front terminals – EF

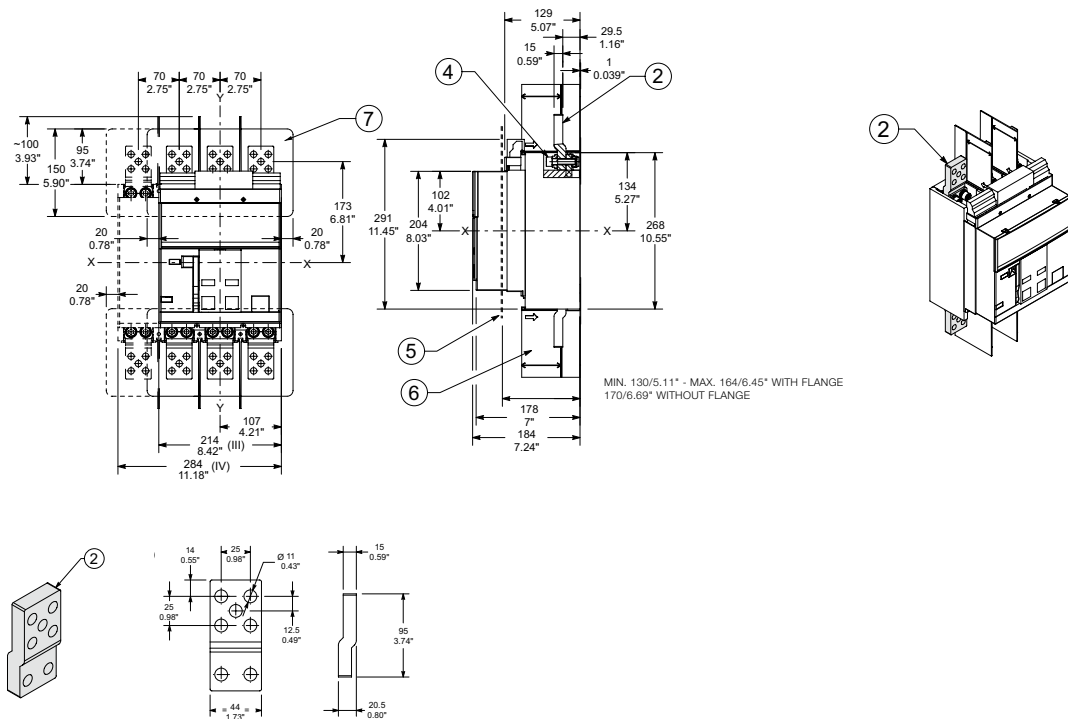

Key

- 1 Front terminals for flat connection
- 2 Extended front terminals
- 3 To be supplied by the customer
- 4 Tightening torque 18Nm - 159lb in
- 5 Door position - Ref. page 7/2
- 6 Obligatory phase separators 100mm/3.93in
- 7 Obligatory insulating plate to be supplied by the customer

Orientable rear terminals - HR/VR

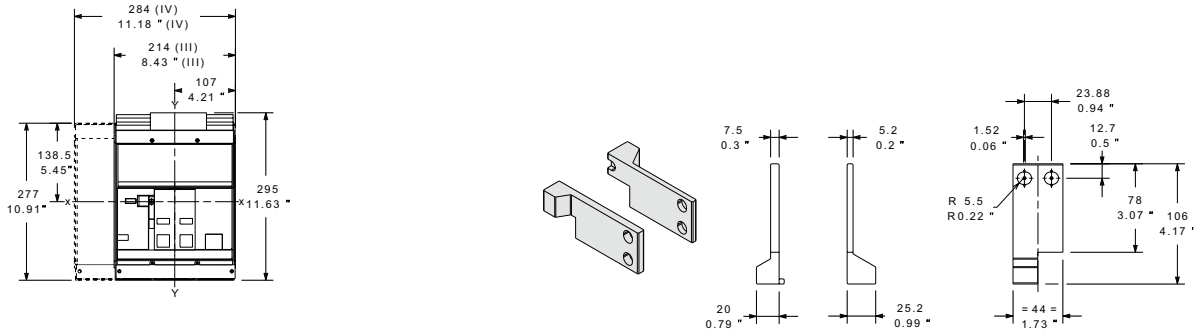

Terminals HR

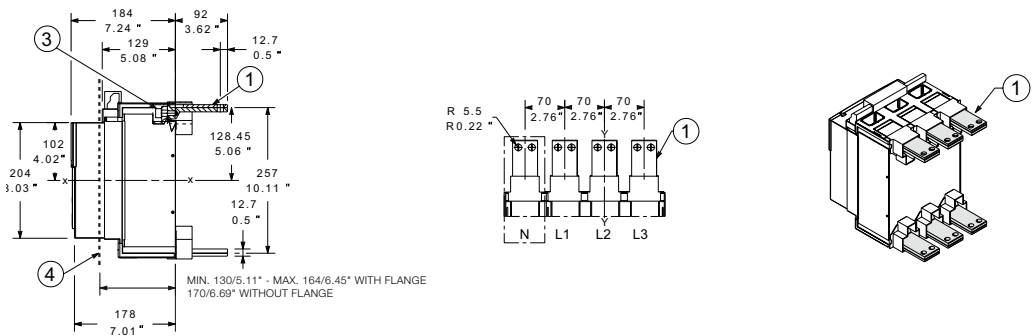

Terminals VR

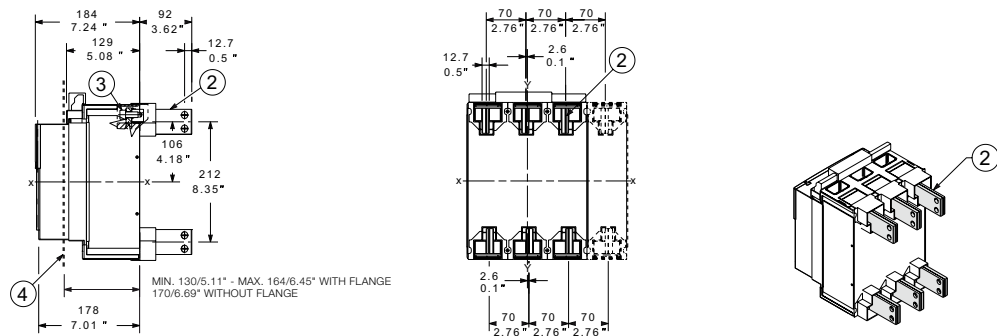

Key

- 1 Horizontal orientable terminals HR
- 2 Vertical orientable terminals VR
- 3 Tightening torque 20Nm - 177lb in
- 4 Door position - Ref. page 7/2

Dimensions

Fixed circuit breaker - E1.2

Spread extended front terminals - ES

3-pole version

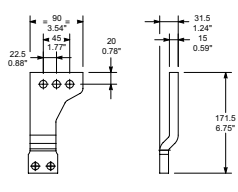
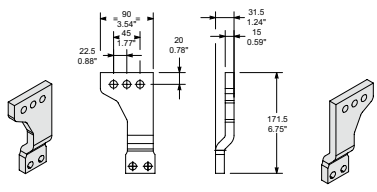
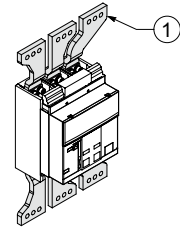
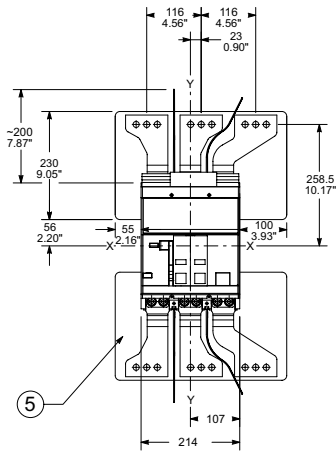

4-pole version

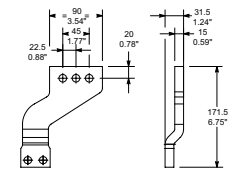
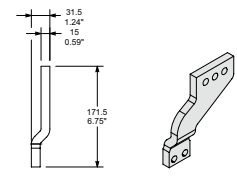
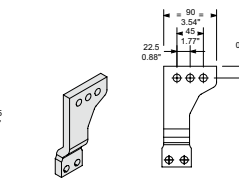
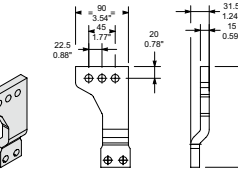
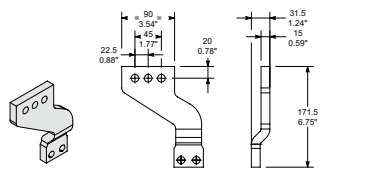
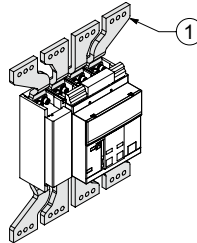
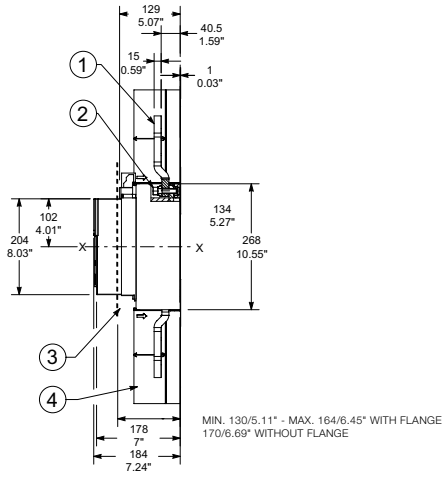
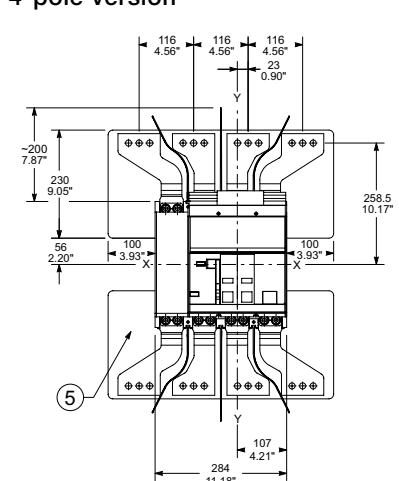

Key

- 1 Splayed extended front terminals
- 2 Tightening torque 18Nm - 159lb in
- 3 Door position - Ref. page 7/2
- 4 Obligatory phase separators 200mm/7.87in
- 5 Obligatory insulating plate to be supplied by the customer

Front terminals for cables – FcCuAl

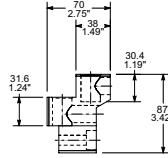
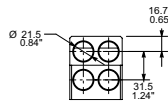
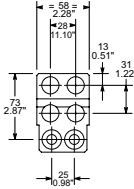
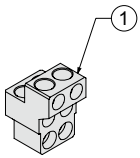
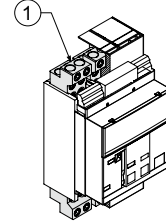
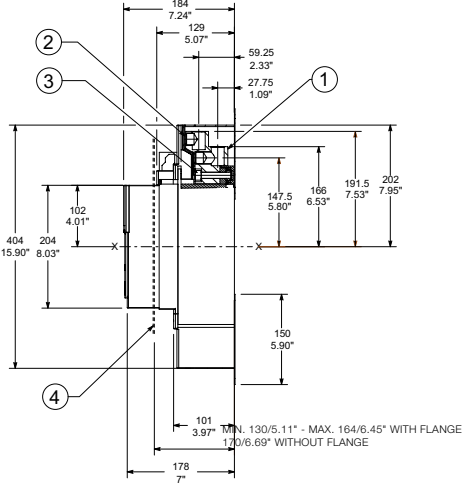
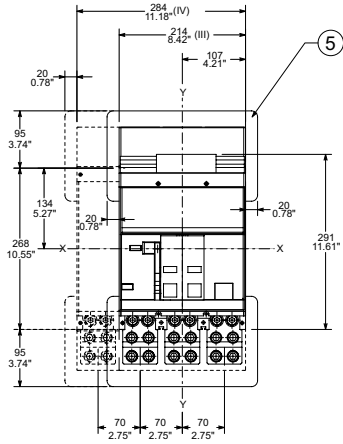

Key

- 1 Front terminals for cables FC CU AL
- 2 Tightening torque 43Nm - 379lb in
- 3 Tightening torque 18Nm - 159lb in

- 4 Door position - Ref. page 7/2
- 5 Obligatory insulating plate to be supplied by the customer

Dimensions

Fixed circuit breaker - E2.2

Orientable rear terminals - HR/VR

E2.2 B-A, N-A, S-A, H-A, V-A 250A - 2000A

VR adjustment

HR adjustment

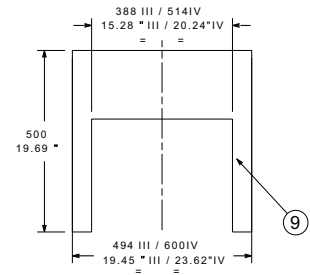
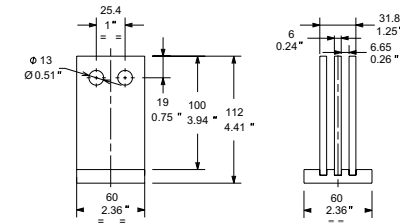
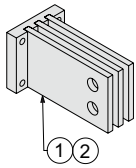
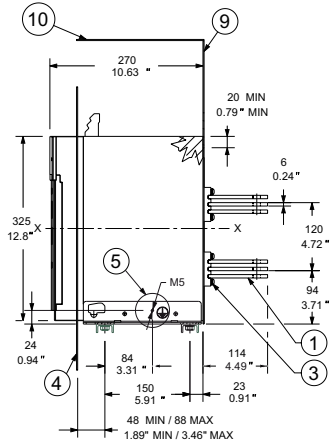
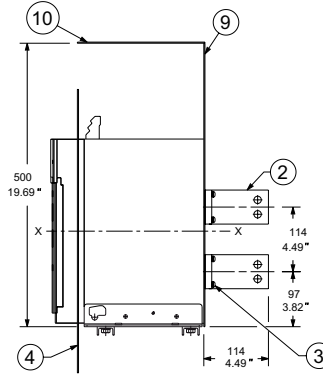
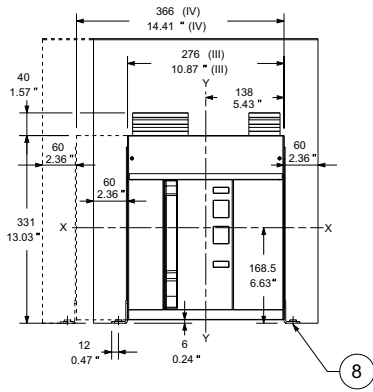

VR adjustment

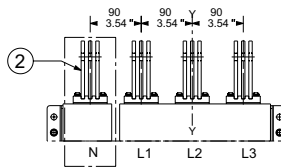

HR adjustment

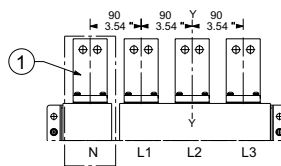

Key

- 1 Horizontal terminals 1600A-2000A
- 2 Vertical terminals 1600A-2000A
- 3 Tightening torque 8.6Nm - 76lb in

- 4 Door position - Ref. page 7/2
- 5 Grounding
- 8 Mounting outside feet

- 9 Insulating sheet or insulated metallic sheet
- 10 Metallic sheet

Front terminals – F

E2.2 B-A, N-A, S-A, H-A, V-A 250A - 2000A

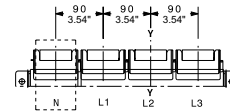
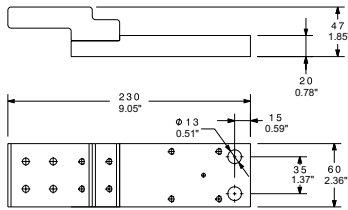
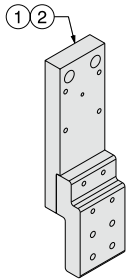
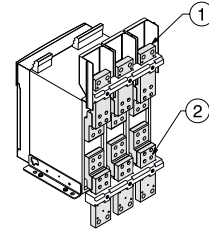
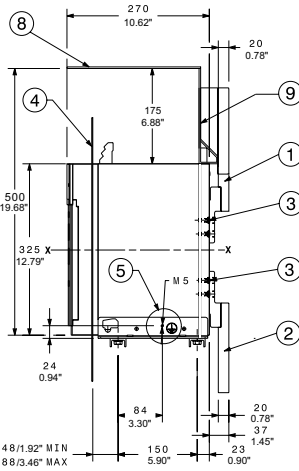
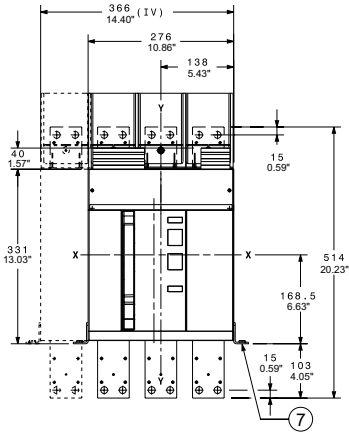

Key

- 1 Upper front terminals
- 2 Lower front terminals
- 3 Tightening torque 8.6Nm - 76lb in
- 4 Door position - Ref. page 7/2
- 8 External fixing point.
Recommended screws M10x25 high class

Vertical rear terminals - VR

E4.2 S-A, H-A, V-A, L-A 3200A

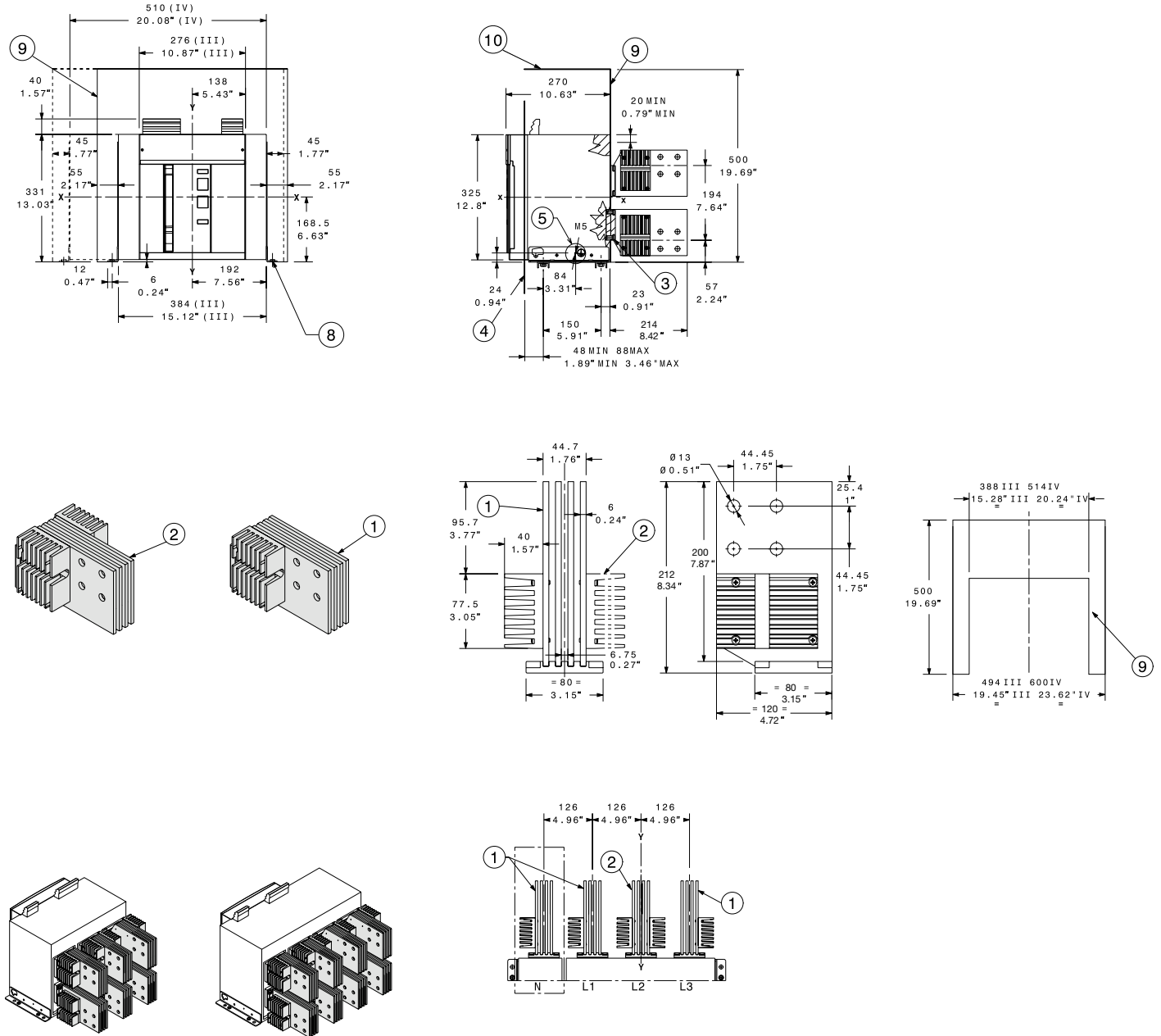

Key

- 1 Lateral vertical terminals 3200A
- 2 Central vertical terminals 3200A
- 3 Tightening torque 20Nm - 177lb in

- 4 Door position - Ref. page 7/2
- 8 Mounting outside feet.
Recommended screws M10x25 high class

- 9 Insulating sheet or insulated metallic sheet
- 10 Metallic sheet

Dimensions

Fixed circuit breaker - E4.2

Front terminals – F

E4.2 S-A, H-A, V-A, L-A 800A - 3200A

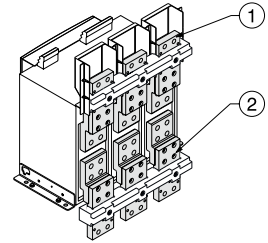
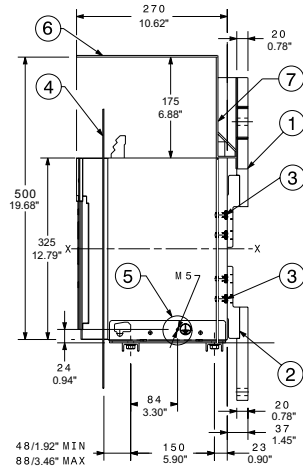
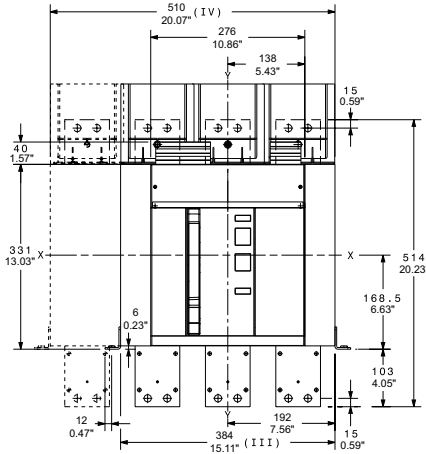

7

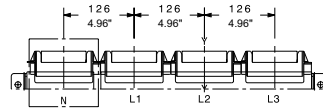
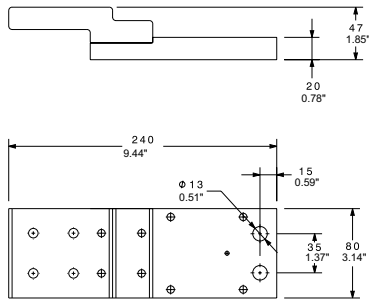
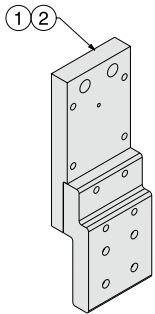

Key

- 1 Upper front terminals
- 2 Lower front terminals
- 3 Tightening torque 8.6Nm - 76lb in
- 4 Door position - Ref. page 7/2
- 5 Earthing device - Ref. page 7/3
- 6 Metallic sheet
- 7 Insulating sheet or insulated metallic sheet

Dimensions

Fixed circuit breaker - E6.2

Orientable rear terminals - HR/VR

E6.2 H-A, V-A, L-A 4000A - 5000A

VR adjustment

HR adjustment

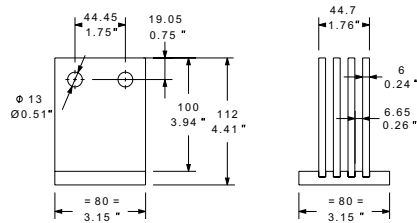
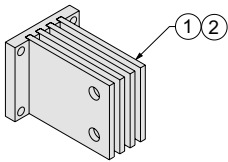
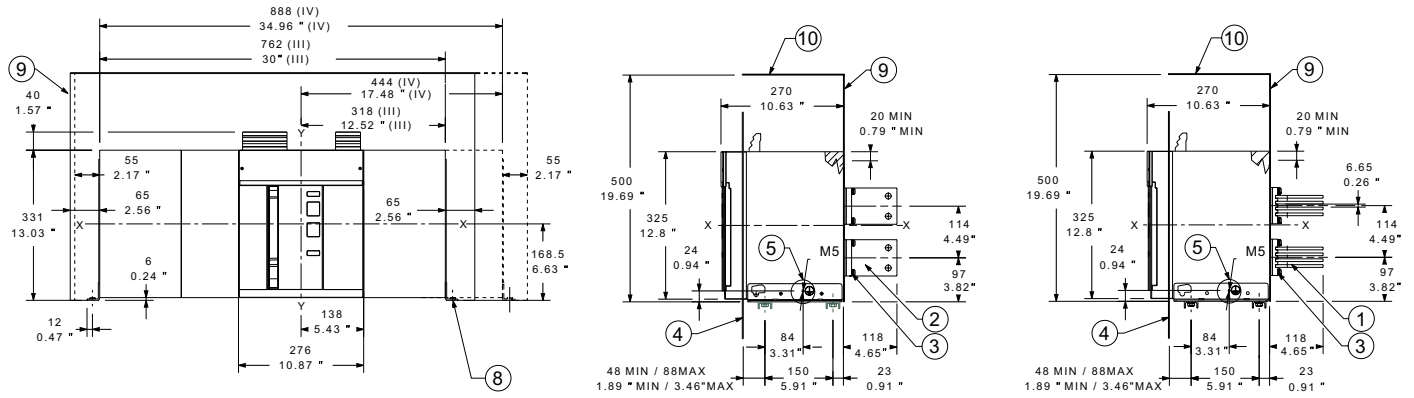

VR adjustment

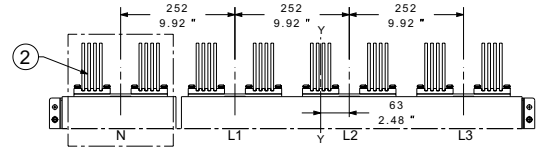
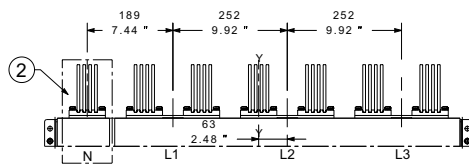
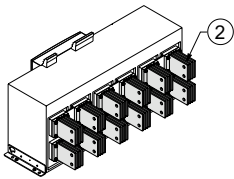

HR adjustment

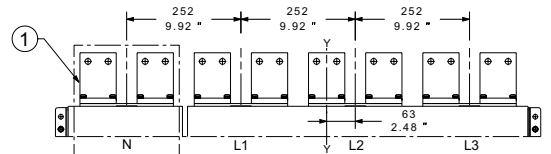
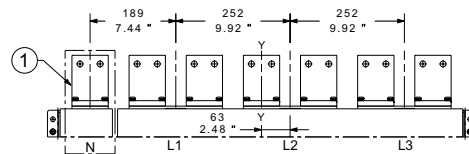
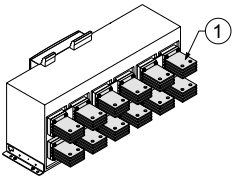

Key

- 1 Horizontal terminals 5000A
- 2 Vertical terminals 5000A
- 3 Tightening torque 20Nm - 177lb in
- 4 Door position

- 5 Grounding
- 6 Ferrule for grounding
- 7 Screws M5x8 provided
Tightening torque 3Nm - 26lb in

- 8 Mounting outside feet
- 9 Insulating sheet or
insulated metallic sheet
- 10 Metallic sheet

1SDC200039D0201_L1L

Dimensions

Fixed circuit breaker - E6.2

Front terminals – F

E6.2 H-A, V-A, L-A 4000A - 5000A

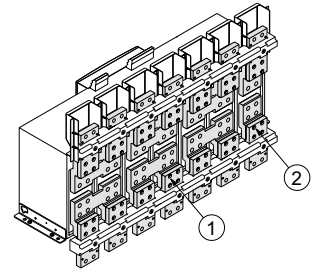
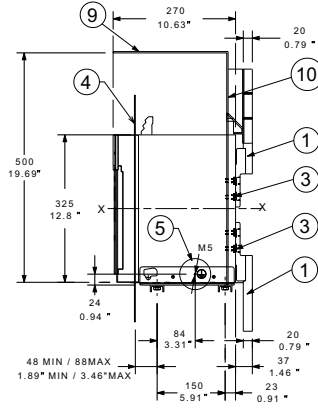
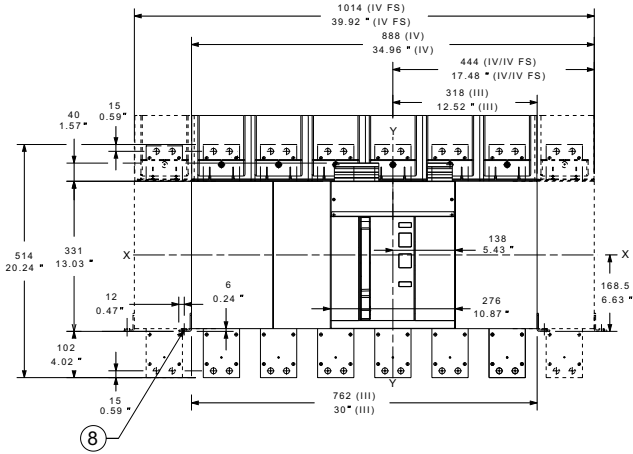

7

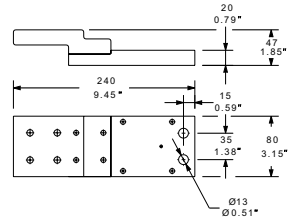
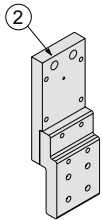
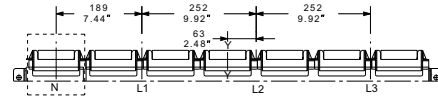
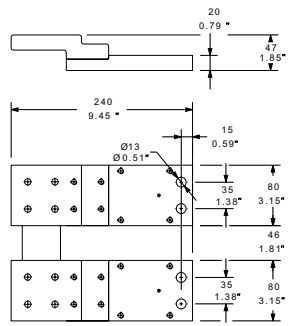
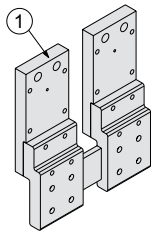

Key

- | | | |
|-------------------------------------|---------------------------------|---|
| 1 Upper and lower front terminals | 4 Door position - Ref. page 7/2 | 9 Metallic sheet |
| 2 Single front terminals | 5 Grounding | 10 Insulating sheet or insulated metallic sheet |
| 3 Tightening torque 20Nm - 177lb in | 8 Mounting outside feet | |

Dimensions

Withdrawable circuit breaker

E1.2

E2.2 - E4.2 - E6.2

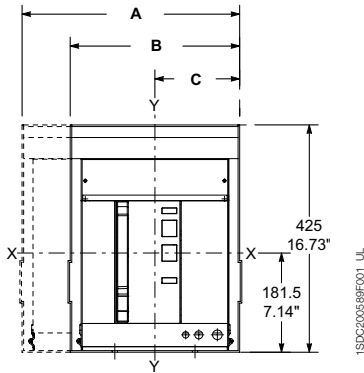
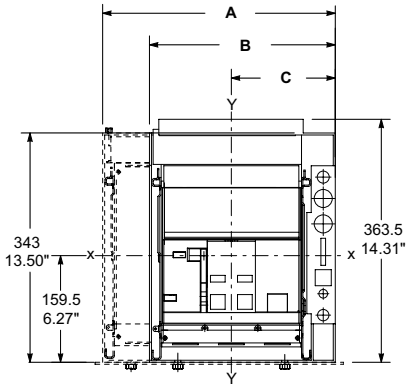

[mm/in]	A 4p	B 3p	C 3p	4p
E1.2	348/13.70	278/10.94	155.5/6.12	155.5/6.12
E2.2	407/16.02	317/12.48	158.5/6.24	158.5/6.24
E4.2	551/21.69	425/16.73	212.5/8.36	212.5/8.36
E6.2	929/36.57	803/31.61	338.5/13.32	464.5/18.28
E6.2/f	1055/41.53	-	-	464.5/18.28

Compartment door drilling

E1.2

E2.2 - E4.2 - E6.2

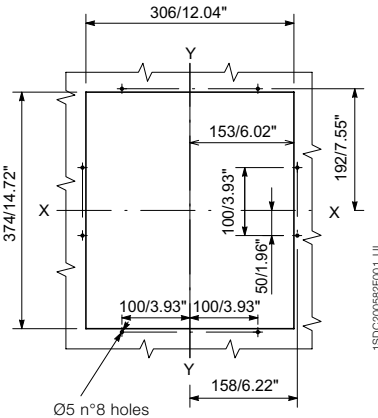
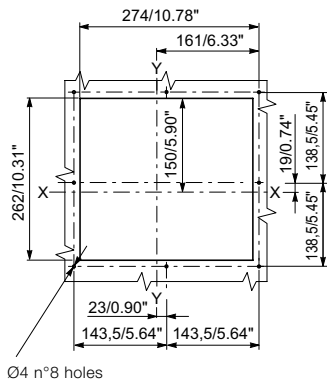

Distance from connected to isolated position

E1.2

E2.2 - E4.2 - E6.2

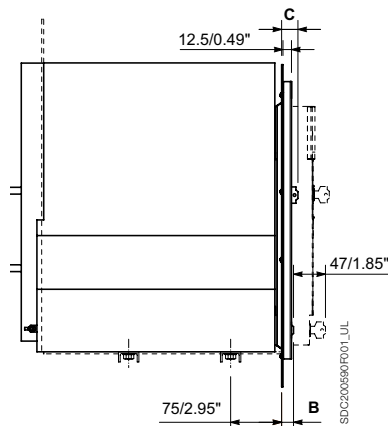
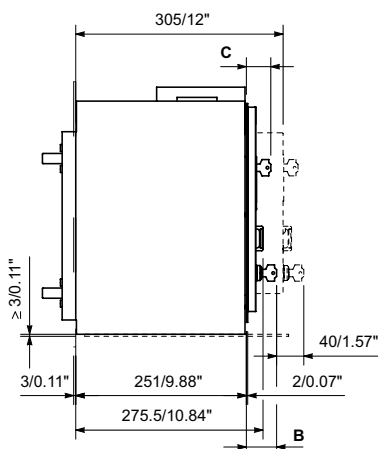

E1.2	Standard	Ronis/Profalux	Kirk	Castell	
B	[mm/in]	44.5/1.75	55/2.16	55/2.16	85
C	[mm/in]	36/1.41	46.5/1.83	46.5/1.83	76.5
E2.2-E4.2	Standard	Ronis/Profalux	Kirk	Castell	
B	[mm/in]	22/0.86	34/1.33	39/1.53	57.5/2.26
C	[mm/in]	23/0.90	35/1.37	40/1.57	58.5/2.30

B refers to KLC; C refers to KLP

Dimensions

Withdrawable circuit breaker

Dimensions of the compartment

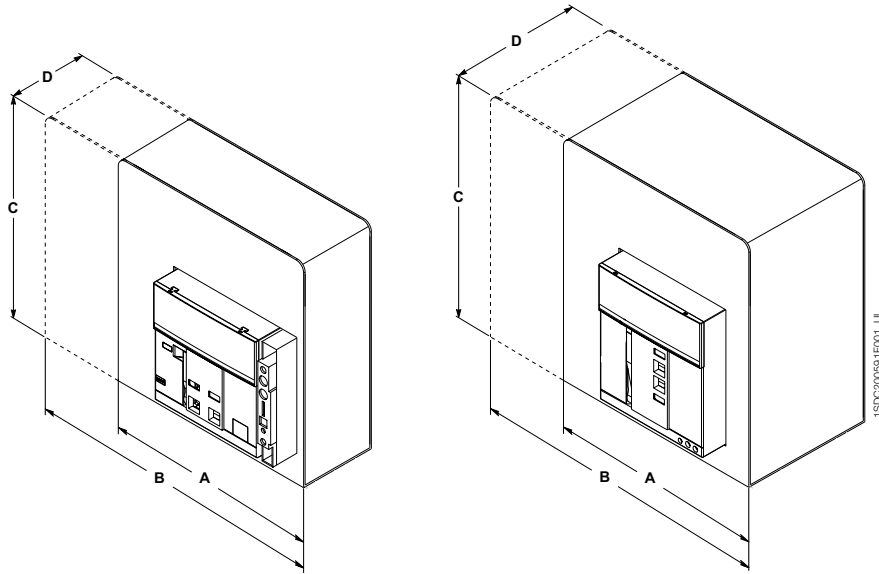

[mm/in]	A	B	C	D
	3p	4p		
E1.2	280/11.02	350/13.77	440/17.32	252/9.92
E2.2	400/15.74	490/19.29	440/17.32	355/13.97
E4.2	500/19.68	620/24.41	440/17.32	355/13.97
E6.2	900/35.43	1020/40.16	440/17.32	355/13.97
E6.2/f		1200/47.24	440/17.32	355/13.97

Floor fixing

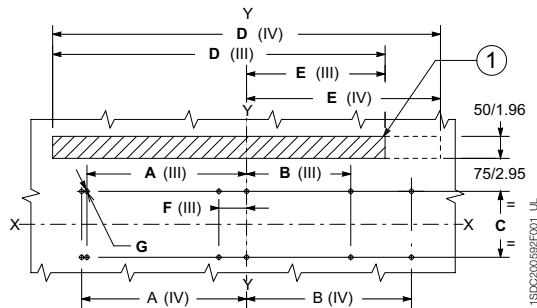

[mm/in]	A		B		C		D		E		F	G
	3p	4p	3p	4p	3p	4p	3p	4p	3p	4p		
E1.2	80/3.14	150/5.90	80/3.14	80/3.14	100/3.93	-	-	-	-	-	-	9/0.35
E2.2	75/2.95	175/6.88	75/2.95	75/2.95	150/5.90	270/10.62	360/14.17	135/5.31	135/5.31	-	-	10/0.39
E4.2	100/3.93	225/8.85	100/3.93	100/3.93	150/5.90	378/14.88	504/19.84	189/7.44	189/7.44	-	-	10/0.39
E6.2	363/14.29	375/14.76	237/9.33	375/14.76	150/5.90	756/29.76	882/34.72	315/12.40	441/17.36	63/2.48	-	10/0.39
E6.2/f	-	425/16.73	-	425/16.73	150/5.90	-	1008/39.68	-	441/17.36	-	-	10/0.39

Key

- 1 Ventilation drilling on the switchgear

Earthing device E2.2 - E4.2 - E6.2

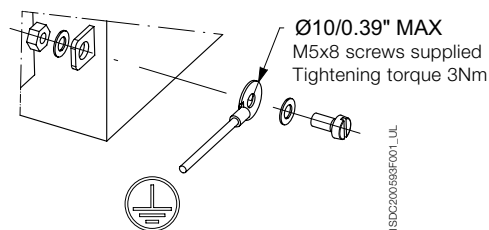

Fixing on support sheet (only for E1.2)

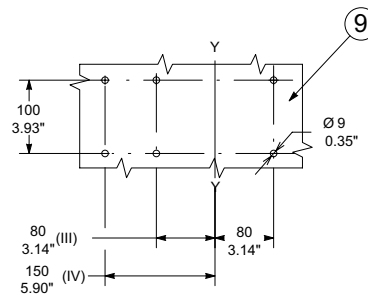

Dimensions

Withdrawable circuit breaker - E1.2

Orientable rear terminals - HR/VR

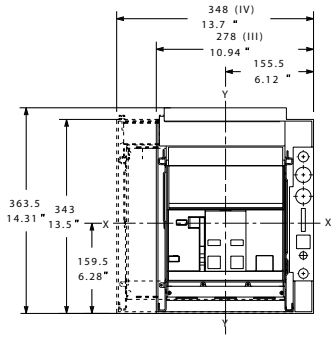

VR adjustment

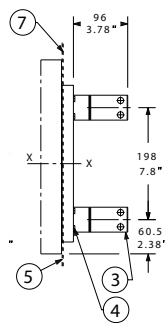

HR adjustment

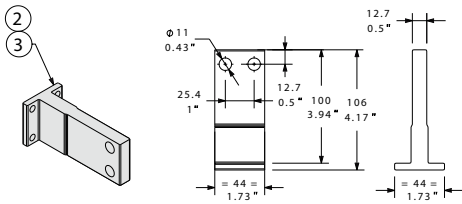
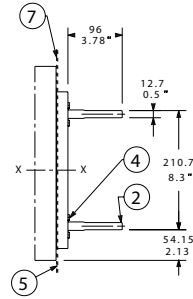

VR adjustment

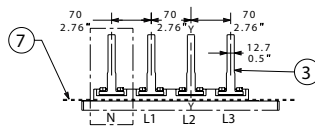

HR adjustment

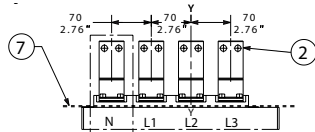

Key

- 2 Horizontal rear terminals
- 3 Vertical rear terminals
- 3 Tightening torque 12 Nm - 106lb in
- 5 Door position - Ref. page 7/12
- 7 Rear segregation for rear terminals
- 8 Insulating Protection

Dimensions

Withdrawable circuit breaker - E1.2

Front spread terminals - ES

3-pole version

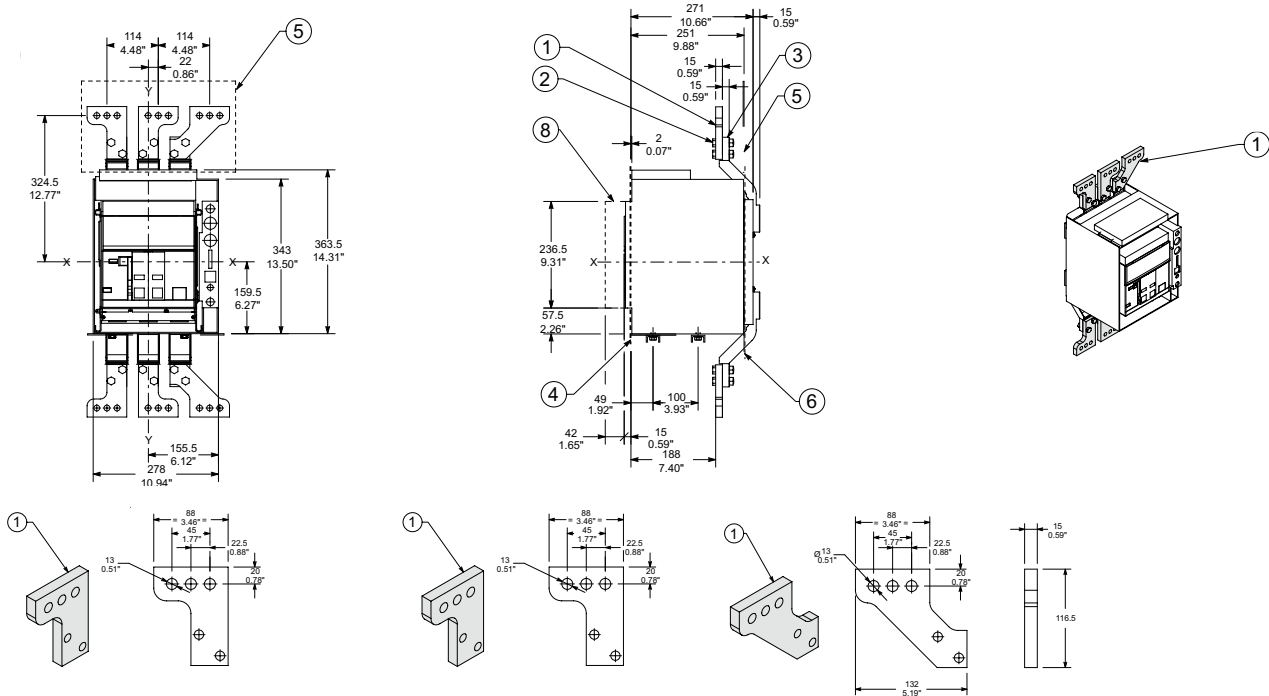

4-pole version

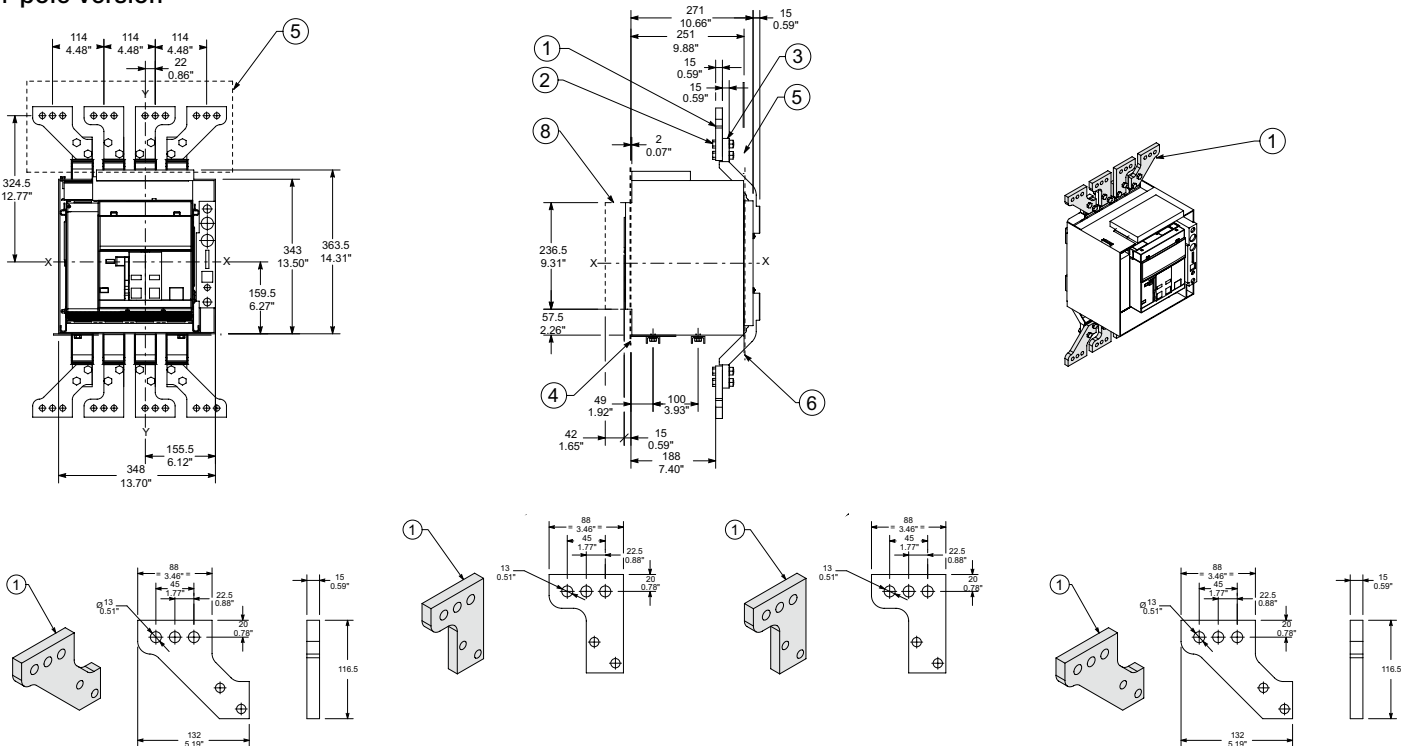

Key

- | | | |
|--------------------------------------|--|---|
| 1 Spread terminal | 4 Door position - Ref. page 7/12 | 6 Rear segregation for front terminals - Ref. page 7/15 |
| 2 Tightening torque 40 Nm - 353lb in | 5 Insulating protection (refer to front terminals page 7/15) | 8 Sectioning run |
| 3 Front terminal | | |

1SDC200016F001_LUL

Dimensions

Withdrawable circuit breaker - E2.2

Orientable rear terminals - HR/VR

E2.2 B-A, N-A, S-A, H-A, V-A 250A - 2000A

VR adjustment

HR adjustment

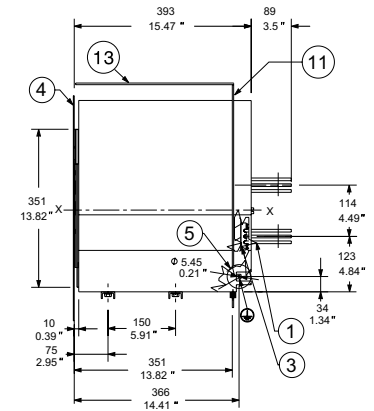
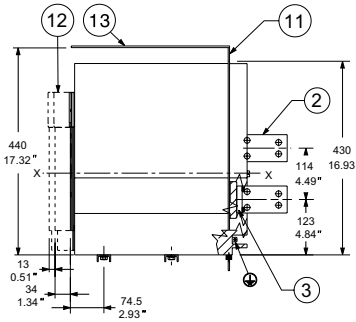
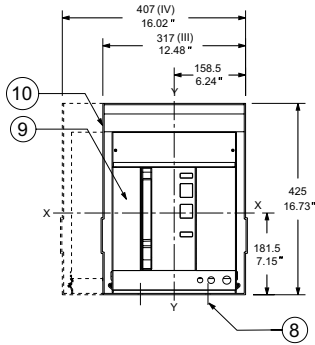

7

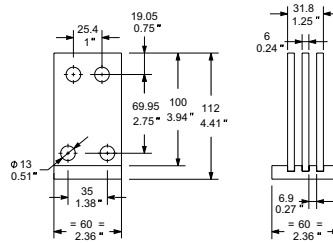
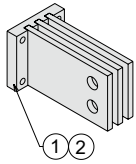

VR adjustment

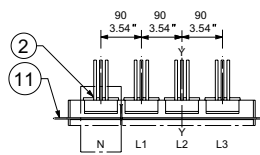

HR adjustment

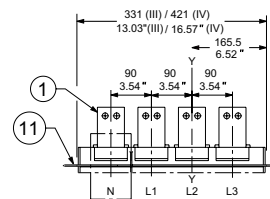

Key

- 1 Horizontal terminals 1600A-2000A
- 2 Vertical terminals 1600A-2000A
- 3 Tightening torque 8.6Nm - 76lb in
- 4 Door position - Ref. page 7/13

- 5 Grounding
- 8 Mounting fixed part screws
- 9 Moving part
- 10 Fixed part

- 11 Segregation
- 12 Connected, test, disconnected distances
- 13 Roof insulation or insulated metal

Front terminals – F

E2.2 B-A, N-A, S-A, H-A, V-A 250A - 2000A

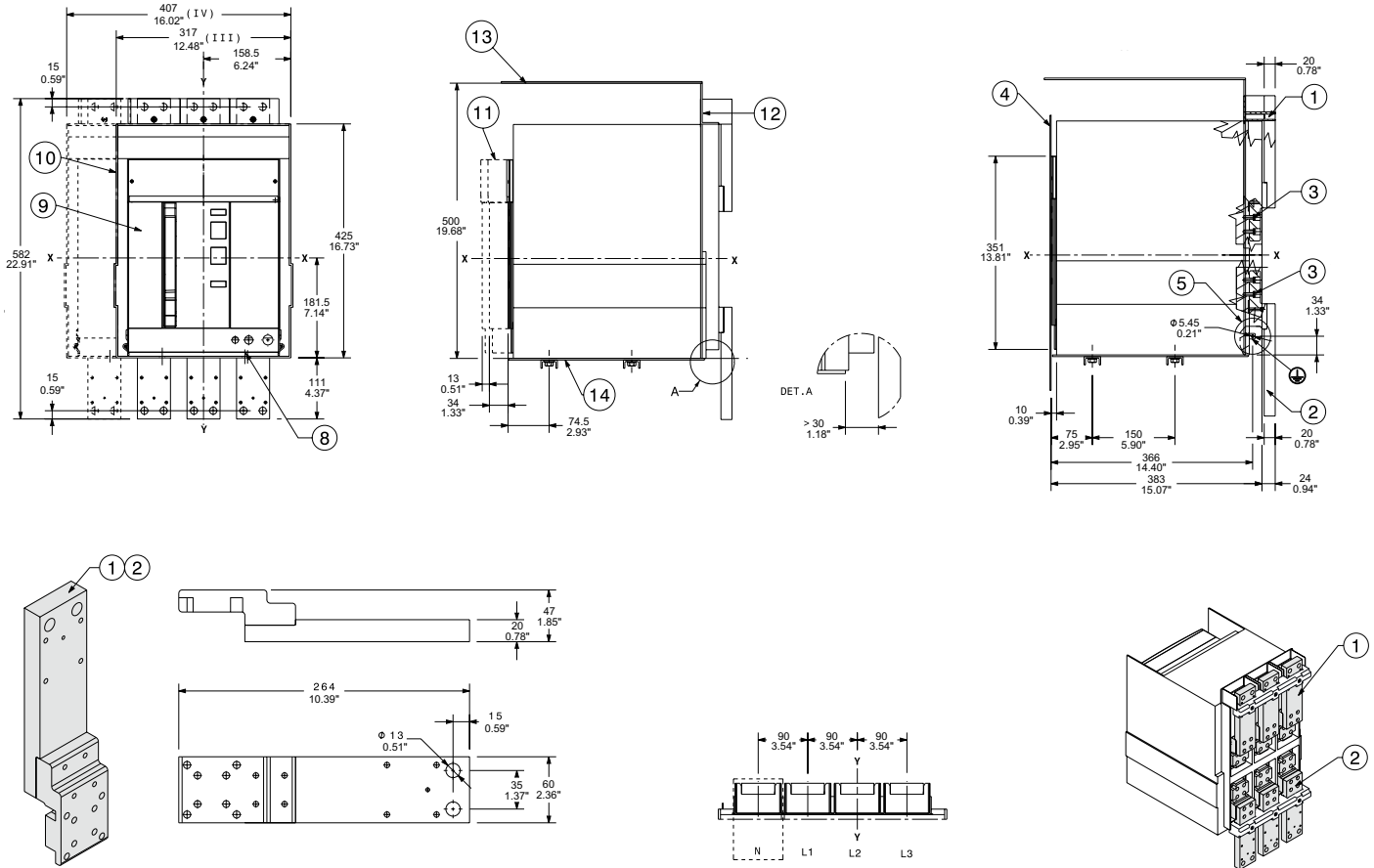

Key

- | | | |
|-------------------------------------|--|---|
| 1 Upper front terminals | 8 External fixing point.
Reccomended screws M10x25 high class | 11 Connected, test, disconnected distances |
| 2 Lower front terminals | 9 Moving part | 12 Insulating sheet or insulated metallic sheet |
| 3 Tightening torque 8.6Nm - 76lb in | 10 Fixed part | 13 Roof insulation or insulated metal |
| 4 Door position - Ref. page 7/13 | | 14 Fixing plate |
| 5 Earthing device | | |

Dimensions

Withdrawable circuit breaker - E4.2

Orientable rear terminals - HR/VR

E4.2 S-A, H-A, V-A 800A - 2500A

VR adjustment

HR adjustment

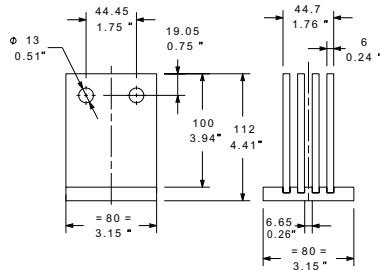
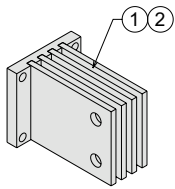
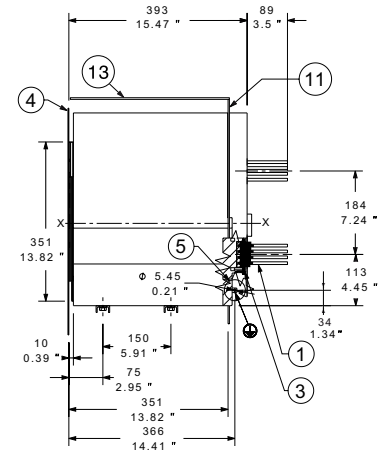
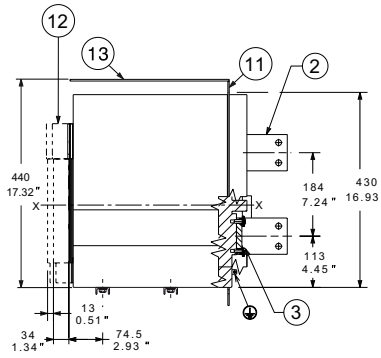
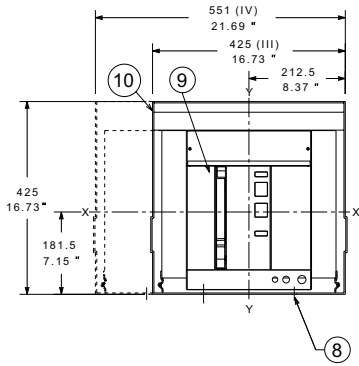

VR adjustment

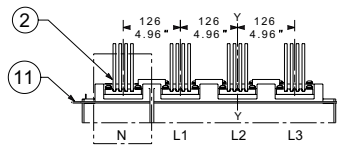
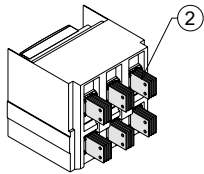

HR adjustment

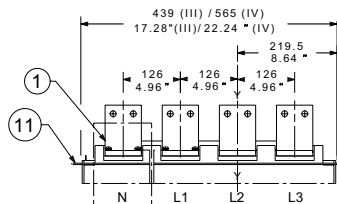
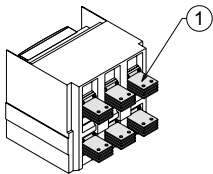

Key

- | | | |
|-------------------------------------|------------------------------|--|
| 1 Horizontal terminals 2500A | 5 Grounding | 11 Segregation |
| 2 Vertical terminals 2500A | 8 Mounting fixed part screws | 12 Connected, test, disconnected distances |
| 3 Tightening torque 20Nm - 177lb in | 9 Moving part | 13 Roof insulation or insulated metal |
| 4 Door position - Ref. page 7/13 | 10 Fixed part | |

Rear terminals VR

E4.2 S-A, H-A, V-A, L-A 3200A

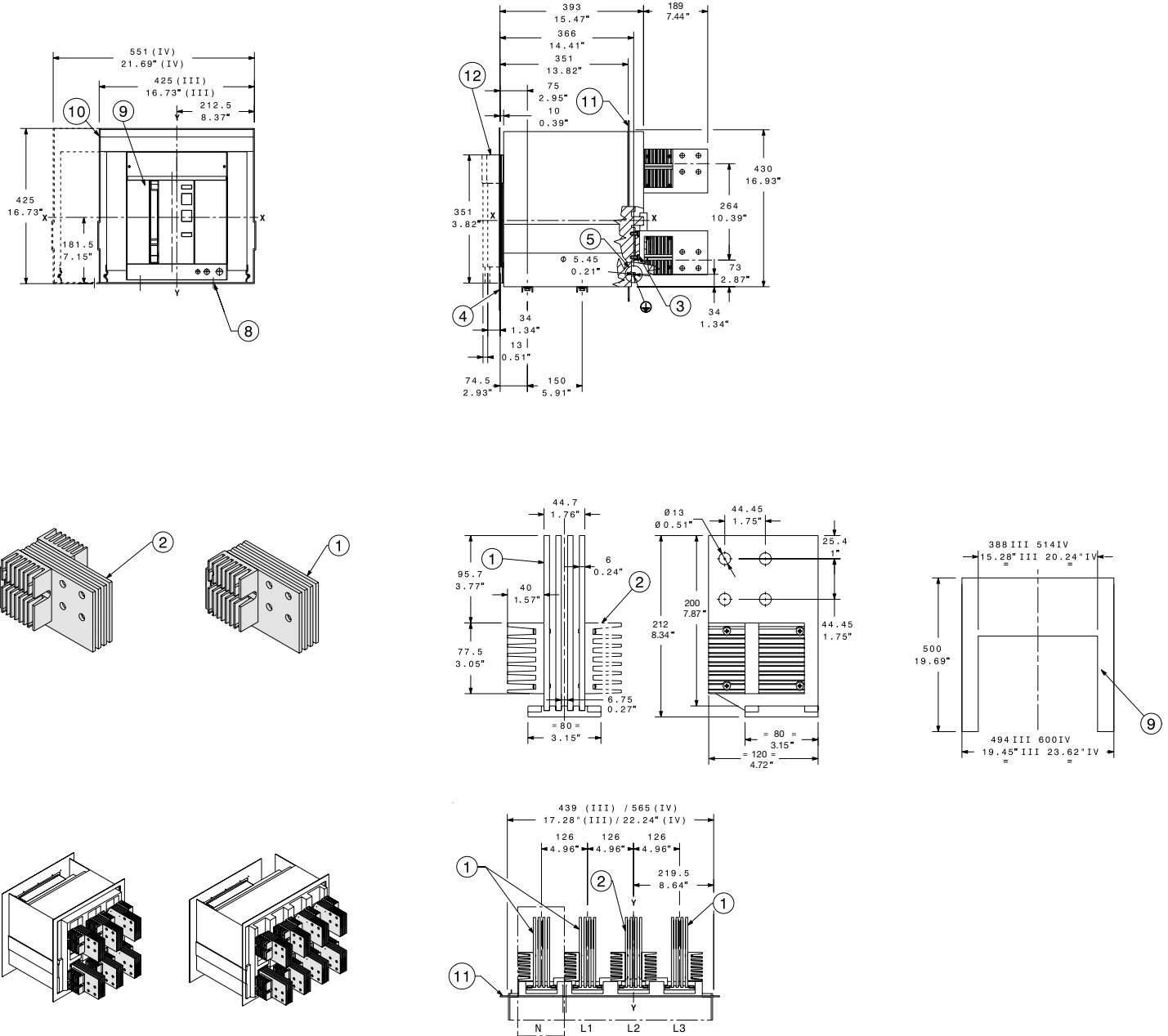

Key

- | | | |
|-------------------------------------|---|---------------------------------------|
| 1 Lateral vertical terminals 3200A | 8 Mounting outside feet.
Recommened screws M10x25 high class | 10 Metallic sheet |
| 2 Central vertical terminals 3200A | 9 Insulating sheet or insulated metallic sheet | 11 Segregation |
| 3 Tightening torque 20Nm - 177lb in | | 13 Roof insulation or insulated metal |
| 4 Door position - Ref. page 7/2 | | |

Dimensions

Withdrawable circuit breaker - E4.2

Front terminals – F

E4.2 S-A, H-A, V-A, L-A 800 - 3200A

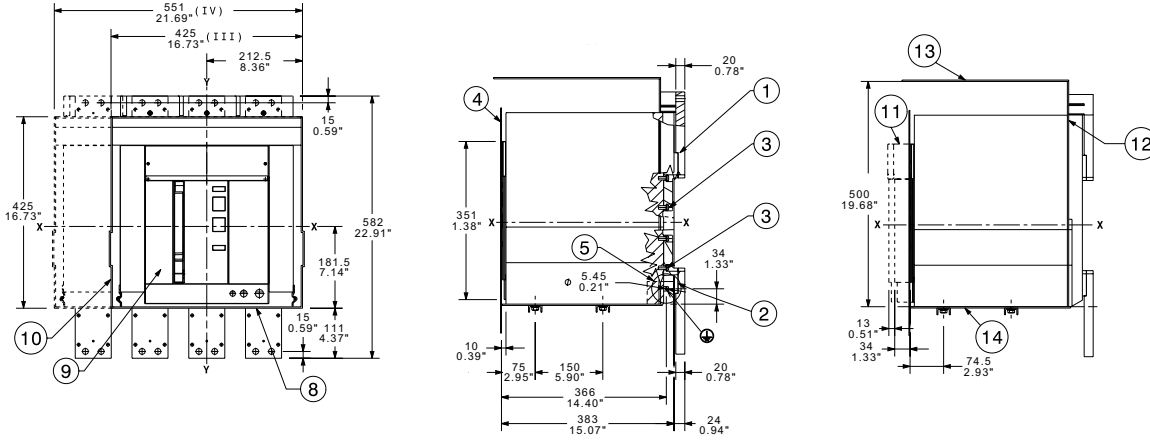

7

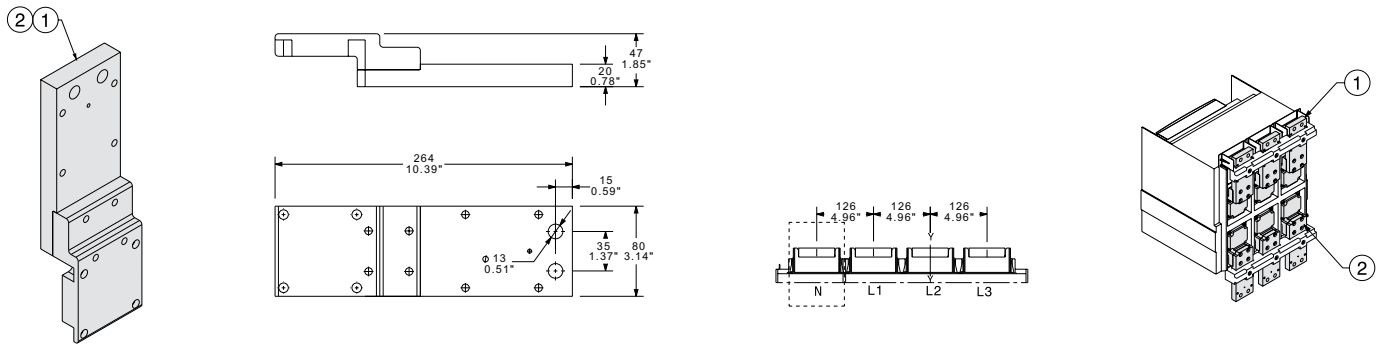

Key

- | | | |
|-------------------------------------|--|---|
| 1 Upper front terminals | 8 External fixing point.
Recommended screws M10x25 high class | 11 Connected, test, disconnected distances |
| 2 Lower front terminals | 9 Moving part | 12 Insulating sheet or insulated metallic sheet |
| 3 Tightening torque 20Nm - 176lb in | 10 Fixed part | 13 Roof insulation or insulated metal |
| 4 Door position - Ref. page 7/13 | | 14 Fixing plate |
| 5 Earthing device | | |

Dimensions

Withdrawable circuit breaker - E6.2

Orientable rear terminals - HR/VR

E6.2 H-A, V-A, L-A 4000A - 5000A

VR adjustment

HR adjustment

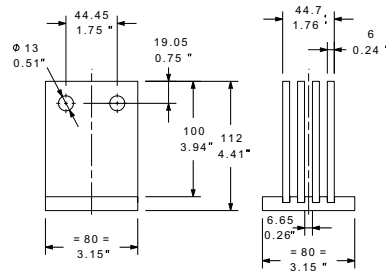
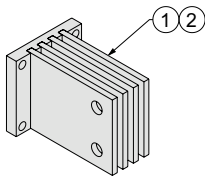
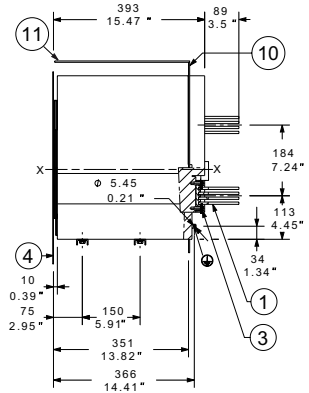
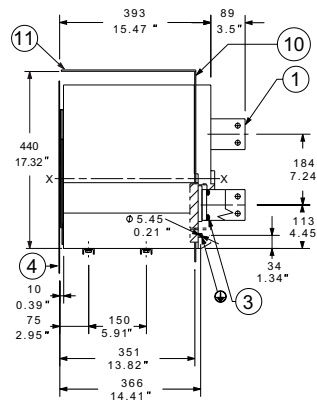
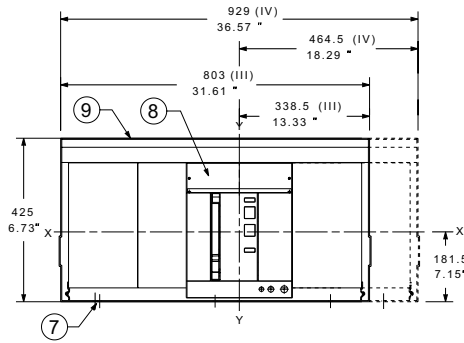

VR adjustment

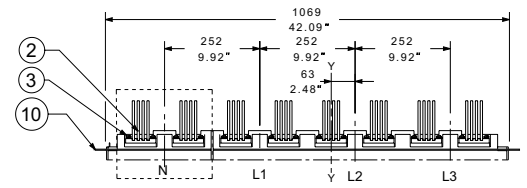
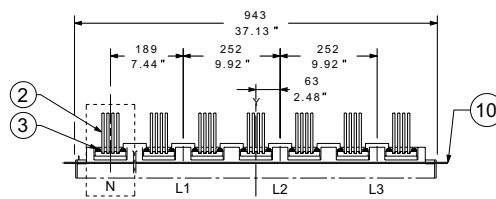

HR adjustment

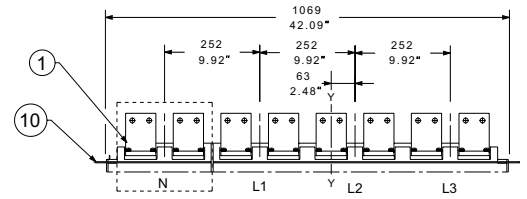
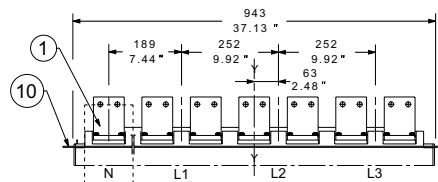

Key

- 1 Horizontal terminals 5000A
- 2 Vertical terminals 5000A
- 3 Tightening torque 20Nm - 177lb in
- 4 Door position
- 7 Mounting fixed part screws M8x25 provided
Tightening torque 20Nm - 177lb in
- 8 Moving part
- 9 Fixed part

- 10 Segregation
- 11 Roof insulation or insulated metal

1SDC20062F001_LUL

Dimensions

Withdrawable circuit breaker - E6.2

Front terminals – F

E6.2 H-A, V-A, L-A 4000A - 5000A

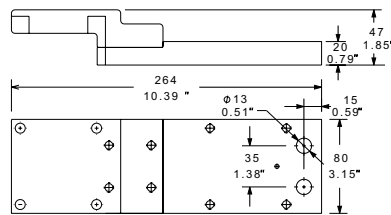
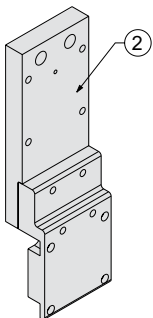
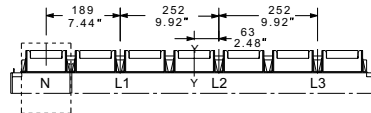
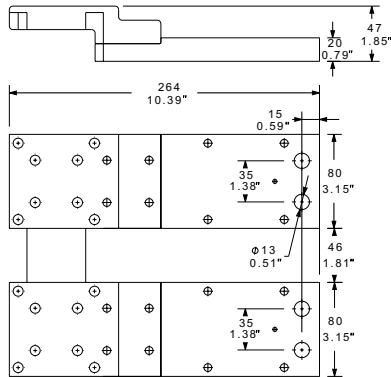
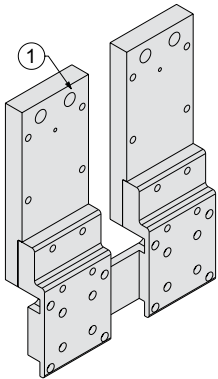
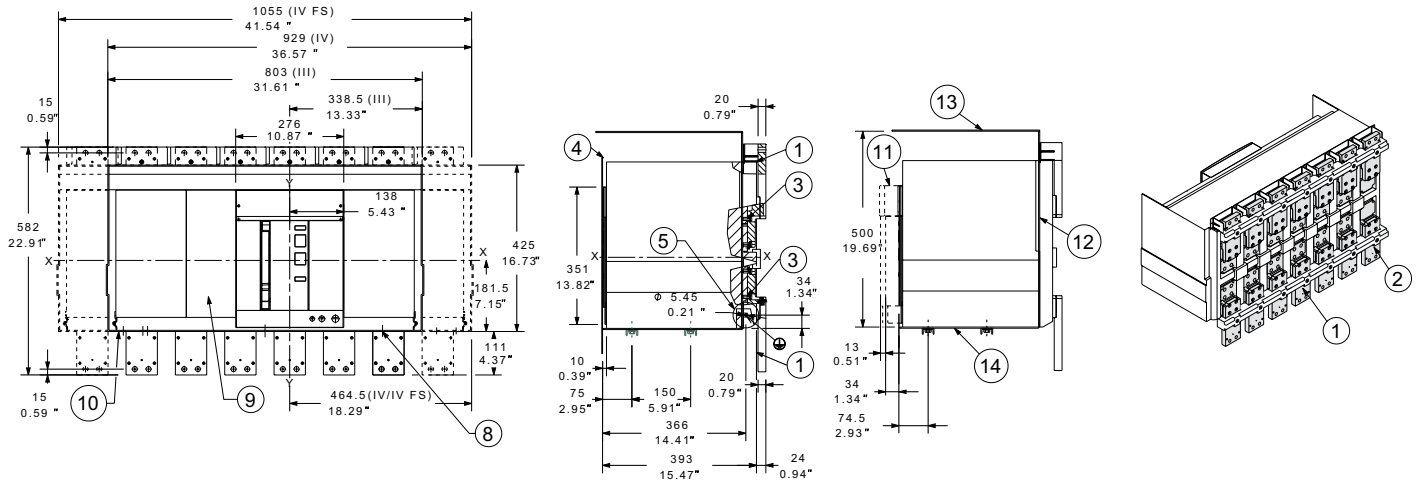

Key

- | | | |
|-------------------------------------|-----------------------|---|
| 1 Upper and lower front terminals | 5 Grounding | 11 Connected, test, disconnected distance |
| 2 Single front terminals | 8 Mounting fixed part | 12 Insulating sheet or insulated metallic sheet |
| 3 Tightening torque 20Nm - 177lb in | 9 Moving part | 13 Roof insulation or insulated metal |
| 4 Door position - Ref. page 7/2 | 10 Fixed part | 14 Fixing plate |

Electrical diagrams

Reading information

Circuit breakers	8/2
ATS021 and ATS022	8/7
Power controller	8/8
Circuit diagram symbols	8/9

Circuit breakers	8/10
------------------	------

Terminal box E1.2	8/11
-------------------	------

Terminal box E2.2 - E4.2 - E6.2	8/12
---------------------------------	------

Electrical accessories	8/13
------------------------	------

ATS021 and ATS022	8/38
-------------------	------

Electrical diagrams

Reading information – Circuit breakers

Operating state shown

The diagram is shown in the following conditions:

- drawout version circuit breaker, open and racked in
- with de-energized circuits
- trip units not tripped
- motor operator with unloaded springs.

Versions

The diagram shows a drawout version circuit breaker, but it is also valid for fixed version circuit breakers.

Fixed version

The control circuits are included between the XV terminals (the X connector is not supplied).

Drawout version

The control circuits are included between the poles of the X connector (the XV terminal box is not supplied).

Description of figures

- 1) Supplementary open/closed auxiliary contacts of the circuit breaker - AUX 6Q (6 Form C)
- 2) Ekip Signalling 4K
- 11) Trip signalling contact
- 12) Contact for signalling position of loaded springs - S33 M/2
- 13) Motor for loading closing springs- M
- 14) Remote reset - YR
- 20) Ekip Measuring/Measuring Pro with voltage socket inside the four pole circuit breaker
- 21) Ekip Measuring/Measuring Pro with voltage sockets inside the three-pole circuit breaker and connection for external neutral
- 22) Ekip Measuring Pro for residual voltage protection (for Ekip G only)
- 23) Ekip Measuring/Measuring Pro with external voltage socket
- 24) Rc residual current protection sensor input
- 25) Transformer star center sensor input
- 26) Zone selectivity
- 27) Current sensor input for external neutral (only for 3-pole circuit breakers)
- 31) Direct auxiliary supply 24V DC and local bus - Ekip Supply
- 32) Auxiliary supply through module 110-240V AC/DC or 24-48V DC and local bus - Ekip Supply
- 41) Ekip signalling 2K-1
- 42) Ekip signalling 2K-2
- 43) Ekip signalling 2K-3
- 48) Ekip Synchrocheck
- 51) Ekip Com Modbus RS-485
- 52) Ekip Com Modbus TCP
- 53) Ekip Com Profibus
- 54) Ekip Com Profinet
- 55) Ekip Com DeviceNet
- 56) Ekip Com EtherNet/IP
- 57) Ekip Com IEC61850
- 58) Ekip Link
- 61) Ekip Com R Modbus RS-485 Redundant
- 62) Ekip Com R Modbus TCP Redundant
- 63) Ekip Com R Profibus Redundant

- 64) Ekip Com R Profinet Redundant
- 65) Ekip Com R DeviceNet Redundant
- 66) Ekip Com R EtherNet/IP Redundant
- 71) Ready to close contact - RTC
- 72) Second shunt trip - YO2
- 73) Undervoltage release - YU
- 74) Undervoltage release with external time-delay device - YU, D
- 75) First shunt trip - YO
- 76) First shunt trip with control from protection trip unit - YO, Ekip Com Actuator
- 77) First closing coil - YC
- 78) First closing coil with control from protection trip unit - YC, Ekip Com Actuator
- 79) Second closing coil - YC2
- 81) Open/closed auxiliary contacts of circuit breaker - AUX 4Q (4 Form C)
- 91) External supplementary open/closed auxiliary contacts of circuit breaker - AUX 15Q (15 Form C)
- 95) Auxiliary position contacts - AUP (E1.2)
- 96) Auxiliary position contacts - AUP (E2.2 - E6.2)
- 97) Supplementary auxiliary position contacts - AUP (E2.2 - E6.2)
- 98) ATS wiring with no auxiliary power supply
- 99) Circuit breakers with auxiliary safety voltage in direct and alternating current
- 100) ATS021
- 101) ATS022
- 102) Controlling a third circuit breaker with ATS022
- 103) Ekip Signalling 10K
- 104) Ekip Multimeter
- 105) Application diagram for Ekip Touch, Hi-Touch, G Touch, G Hi-Touch with Power Controller function.

Electrical diagrams

Reading information – Circuit breakers

Key

*	= See the note indicated by the letter
A1	= Applications located on the mobile part of the circuit breaker
A3	= Applications located on the cradle of the circuit breaker
A4	= Indicative devices and connections for control and signalling, outside the circuit breaker
BUS1	= Serial interface with external bus
D	= Electronic time-delay device of YU undervoltage release, outside the circuit breaker
F1	= Time-delayed trip fuse
GZi(DBi)	= Zone selectivity input for G protection or input in “reverse” direction for D protection
GZo(DBo)	= Zone selectivity output for G protection or output in “reverse” direction for D protection
I O1...32	= Programmable digital inputs of the EKIP protection trip unit
K51	= Electronic overcurrent protection trip unit of the types: EKIP DIP, EKIP TOUCH, EKIP LCD, EKIP HI-TOUCH , EKIP HI-LCD, EKIP G TOUCH, EKIP G LCD, EKIP G HI-TOUCH , EKIP G HI-LCD
K51/COM	= Communication module
K51/MEAS	= Measurement module
K51/SIGN	= Signalling module
K51/SUPPLY	= Optional auxiliary supply module (110-220VAC/DC and 24-48VDC)
K51/SYNC	= Synchronization module
K51/YC	= Closing control from the Ekip protection trip unit
K51/YO	= Opening control from the Ekip protection trip unit
M	= Motor for loading closing springs
O 01...32	= Programmable signalling contacts of the Ekip protection trip unit
O SC	= Ekip protection trip unit contact for synchronism control
Q	= Circuit breaker
Q/1...Q/25	= Auxiliary contacts of circuit breaker
Q/26...Q/27	= Auxiliary open/close contacts used internally by the trip unit
RC	= RC (residual current) protection sensor
RT1...RT3	= Temperature sensors
RTC EKIP	= Auxiliary ready to close contact of circuit breaker, used internally by the trip unit
RTC	= Contact for signalling circuit breaker is ready to close
S33M/1...2	= Limit contacts of spring loading motor
S43	= Switch for presetting remote/local control
S51	= Trip signalling contact (bell alarm)
S75E/1...4	= Contacts for signalling circuit breaker in racked out position (provided only with drawout version)
S75I/1...5	= Contacts for signalling circuit breaker in racked in position (provided only with drawout version)
S75T/1...2	= Contact for signalling circuit breaker in test position (provided only with drawout version)
SC	= Pushbutton or contact for closing the circuit breaker
SO	= Pushbutton or contact for immediate opening of the circuit breaker
SO1	= Pushbutton or contact for opening the circuit breaker with UVR time-delayed trip
SR	= Pushbutton or contact for remote electrical resetting of S51 (bell alarm) trip contact
SZi(DFi)	= Input for zone selectivity for S protection or input in “direct” direction for S protection
SZo(DFo)	= Output for zone selectivity for S protection or output in “direct” direction for D protection
TI/L1	= Current transformer phase L1
TI/L2	= Current transformer phase L2
TI/L3	= Current transformer phase L3
TI/N	= Current transformer on neutral
TU1...TU2	= Insulation voltage transformer (outside circuit breaker)
Uaux	= Auxiliary power supply
UI/L1	= Current sensor phase L1

UI/L2	= Current sensor phase L2
UI/L3	= Current sensor on phase L3
UI/N	= Current sensor on neutral
UI/O	= Single-pole current sensor
W2	= Serial interface with internal bus (local bus)
W9...W13	= RJ45 connector for communication modules
W9R.W11R	= RJ45 connector for redundant communication modules
X	= Delivery connector for auxiliary circuits for drawout version of circuit breaker
XB1...XB7	= Connectors for circuit breaker applications
XF	= Delivery terminal board for position contacts of drawout version of circuit breaker
XK1...XK3	= Connectors for auxiliary circuits of the Ekip protection trip unit
XK7	= Connector for auxiliary circuits of communication module
XV	= Delivery terminal box for auxiliary circuits of fixed version circuit breaker
YC	= Closing coil
YC2	= Second closing coil
YO	= Shunt trip
YO1	= Shunt trip for overcurrent
YO2	= Second shunt trip
YR	= Remote reset
YU	= Undervoltage release

Electrical diagrams

Reading information – Circuit breakers

Notes

- A) Auxiliary supply for Ekip trip unit is mandatory (refer to diagram 1SDM00009R0001 figures 31 - 32- 33 - 34).
- B) When there are mixed auxiliary contacts Q1 and Q2 are rated for 400V, while Q3 and Q4 are rated for 24V. Then Q5, Q6, Q7 are 400V, while Q8, Q9, Q10 are 24V.
- C) Always supplied with Ekip Com module.
- D) Always supplied with motor for loading closing springs in Fig. 13.
- E) Mandatory voltage transformer in the case of external sockets. Mandatory external sockets for systems with rated voltage greater than 690V.
- F) The connections between the RC residual current protection sensor and the poles of the X connector (or XV) of the circuit breaker must be made with 4-pole shielded cable with conductors interwoven in pairs (type BELDEN 9696 paired or equivalent), of a length no greater than 32.8ft/10m. The shield should be earthed on the circuit breaker side.
- G) Gext- protection against earth fault is available for all displayed electronic trip units with LSIG protection. The current sensor must be positioned on the star center of the MV/LV transformer.
The connection between terminals 1 and 2 of the UI/O current transformer and Ge+ and Ge- poles of the X connector (or XV) must be made with shielded and stranded 2-pole cable (type BELDEN 9841 or equivalent) of length no greater than 49.2ft/15m.
- H) The connection between the terminal box and external neutral sensor must be made with the 6.5ft/2m cable provided. For three pole circuit breakers, the Ne+ and Ne- poles of the X connector (or XV) must be short-circuited if no sensor is present on the external neutral conductor.
- I) Mandatory with the use of any Ekip module.
- J) Only for E2.2, E4.2 and E6.2 drawout version circuit breakers as an alternative to Fig. 31-32-34.
- K) Only for E2.2, E4.2 and E6.2 drawout version circuit breakers as an alternative to Fig. 31-32-33.
- L) In the presence of Fig. 32, for E2.2, E4.2 and E6.2 circuit breakers, one each of up to 3 options between Fig. 41...58 can be utilized. Likewise, E1.2 circuit breakers, up to two applications between Fig. 41...58 can be used. The Ekip Com module selected can be duplicated if required, by choosing between Fig. 61...66.
- N) In the presence of Fig. 34, for E2.2, E4.2 and E6.2 circuit breakers, a single application between Fig. 41...58 can be used.
- O) In the presence of several Ekip Com modules with drawout version circuit breakers, the contact S75I/5 should be connected only once to a single module.
- P) The auxiliary voltage Uaux. enables activation of all the functions of the EKIP electronic protection trip units. Since an earth insulated Uaux was requested, it is necessary to use “galvanically separated convertors” which comply with the standards IEC 60950 (UL 1950) or equivalent, which guarantee a common mode current or leakage current (refer to IEC 478/1, CEI 22/3) no greater than 3.5mA, IEC 60364-41 and CEI 64-8.
- Q) Regarding local bus the maximum cable length is 49.2ft/15m..

Electrical diagrams

Reading information – ATS021 and ATS022 (IEC only)

Operating state shown

The diagram is shown in the following conditions:

- circuit breakers open and racked in #
- with de-energized circuits
- trip units not tripped *
- unloaded closing springs.

Key

A	=	ATS021 and ATS022 devices for automatic switching of two circuit breakers
CB1-N	=	Normal supply line circuit breaker
CB2-E	=	Emergency supply line circuit breaker
K1	=	Auxiliary contactor type NF22E for voltage presence of normal power supply
K2	=	Auxiliary contactor type NF22E for voltage presence of emergency power supply
KC1-KC2	=	Auxiliary contactors type AL__-30 circuit breaker closing
KO1-KO2	=	Auxiliary contactors type AL__-30 circuit breaker opening
M	=	Motor for loading the closing springs
Q/1	=	Auxiliary contact of the circuit breaker
Q60	=	Thermal protection for isolating and protecting the auxiliary circuits of safety auxiliary voltage
Q61/1-2	=	Thermal protection for isolating and protecting the auxiliary circuits of the lines
S11	=	Contact for enabling automatic switching of the ATS021 device
S11...S15	=	Signalling contacts for the inputs of the ATS022 device
S1-S2	=	Contacts controlled by the cam of the motor operator
S3	=	Changeover contact for electrical signalling of local/remote selector state
S33M/1	=	Limit contacts of spring charging motor
S51	=	Contact for electrical signalling of circuit breaker open due to tripping of overcurrent trip unit (bell alarm)
S75I/1	=	Contact for signalling circuit breaker racked in #
BUS 1	=	Serial interface with control system (MODBUS EIA RS485 interface) available with the device ATS022
X	=	Connector for auxiliary circuits of drawout version circuit breakers
XF	=	Delivery terminal box for the position contacts of the circuit breaker
XV	=	Delivery terminal box for the auxiliary circuits of the fixed version circuit breakers
YC	=	Closing coil
YO	=	Shunt trip

This diagram shows the drawout version circuit breakers, but it is also valid for the fixed version circuit breakers. In this case, it is not necessary to connect the S75I/1 contacts on the X31:1 input of the ATS021 device otherwise it is necessary to connect the X32:5 and X32:6 terminals with the terminal X32:9 of the ATS022 device.

* This diagram shows circuit breakers with overcurrent release but it is also valid for circuit breakers without release (switch disconnectors). If the S51 (bell alarm) contact is not present, the S51 contacts on the X31:1 input of the ATS021 device should not be considered, while it is necessary to connect the X32:7 and X32:8 terminals with the X32:9 terminal of the ATS022 device.

Electrical diagrams

Reading information – Power Controller

Operating state shown

The diagram is shown in the following conditions:









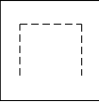
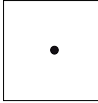
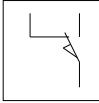
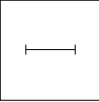
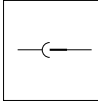
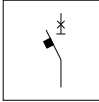

- circuit breaker, open and racked in #
- with de-energized circuits
- trip units not tripped *
- motor operator with unloaded springs.

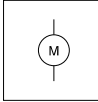
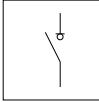
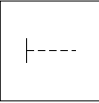
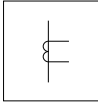
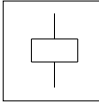
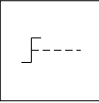
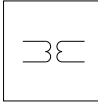
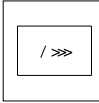
Key

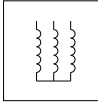
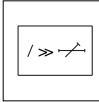
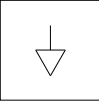
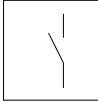
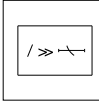
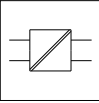
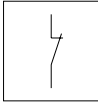
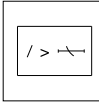
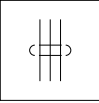
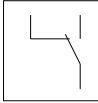
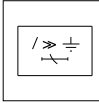
A13	= Ekip Signalling 10K unit
A17	= MOE actuator unit for stored energy operating mechanism for the Tmax XT circuit breaker
A21	= EtherNet Switch device
FI	= Time-delayed trip fuse
I 01 ... 12	= Programmable digital inputs of the Ekip protection trip unit
J ..	= Connectors for auxiliary circuits of the Tmax XT circuit breaker in the drawout version
K51	= Ekip electronic overcurrent protection trip unit for Emax 2 circuit breaker
K51/COM	= Communication module for the Ekip trip unit
K51/SIGN	= Signalling module for Ekip trip unit
K51/SUPPLY	= Optional auxiliary supply module for the Ekip trip unit
K51/YC	= Closing control from the Ekip protection trip unit
K51/YO	= Opening control from the Ekip protection trip unit
M	= Motor for loading closing springs for Emax 2 circuit breaker
M	= Motor for opening the circuit breaker and for loading closing springs for Tmax XT circuit breakers
O 01 ... 12	= Programmable signalling contacts of the EKIP protection trip unit
Q/1	= Auxiliary contacts of circuit breaker
Q1	= Emax 2 circuit breaker equipped with Ekip Power Controller
Q2	= Emax 2 circuit breaker
Q3	= Tmax XT circuit breaker equipped with MOE actuator unit
Q4	= Emax 2 MS switch-disconnector
R1	= Resistor
S33M/1	= Limit contacts of spring loading motor
S51	= Trip signalling contact (bell alarm)
S75I/5	= Contacts for signalling Emax 2 circuit breaker in racked in position (provided only for drawout version)
W13	= RJ45 connector for communication modules
X	= Delivery connector for auxiliary circuits for drawout version of Emax 2 circuit breaker
XV	= Delivery terminal box for auxiliary circuits of fixed version circuit breaker
YC	= Closing coil
YO	= Shunt trip

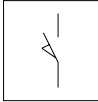
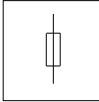
Electrical diagrams

Circuit diagram symbols (IEC 60617 standards)

	Shield (may be drawn in any shape)		Terminal		Position switch (limit switch) change-over break before make contact
	Delay		Plug and socket (male and female)		Circuit breaker- disconnector with automatic trip unit
	Mechanical connection (link)		Motor (general symbol)		Switch disconnector (on-load isolating switch)
	Manually operated control (general case)		Current transformer		Operating device (general symbol)
	Operated by turning		Voltage transformer		Instantaneous overcurrent or rate-of-rise relay
	Operated by pushing		Winding of three-phase transformer, connection star		Overcurrent relay with adjustable short time-lag characteristic
	Equipotentiality		Make contact		Overcurrent relay with inverse short time-lag characteristic
	Converter with galvanic separator		Break contact		Overcurrent relay with inverse long time-lag characteristic
	Conductors in a screened cable (i.e., 3 conductors shown)		Change-over break before make contact		Earth fault overcurrent relay with inverse short time-lag characteristic
	Twisted conductors (i.e., 3 conductors shown)		Position switch (limit switch), make contact		Fuse (general symbol)
	Connection of conductors		Position switch (limit switch), break contact		Current sensing element

Electrical diagrams

Circuit breakers

3-pole or 4-pole circuit breaker

8

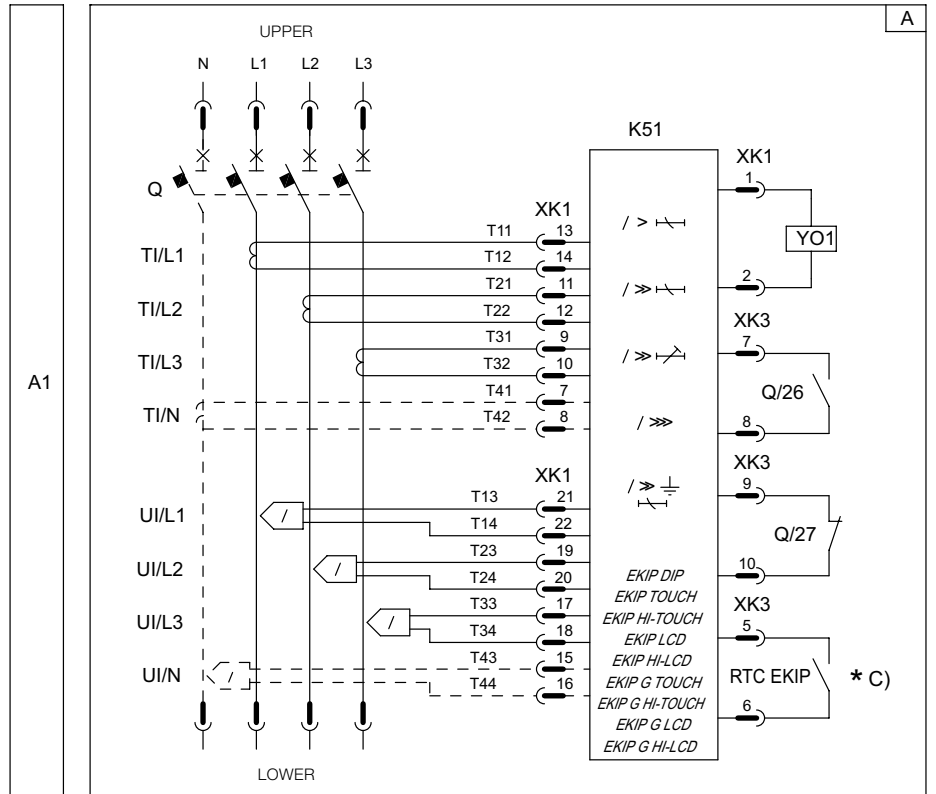

3-pole or 4-pole switch disconnector

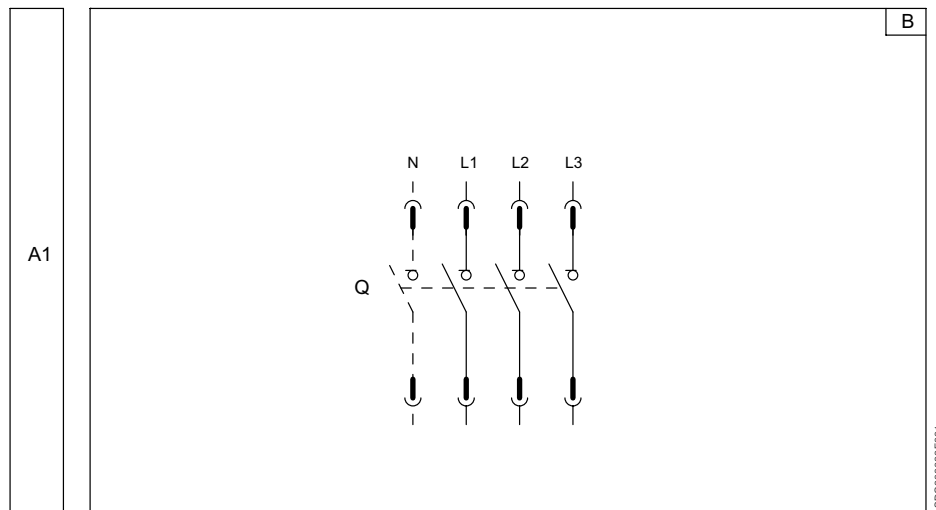

Electrical diagrams

Electrical accessories

51	61	71	81	91	01	95	35	R1	V3	Vn	Ge+	Szi	Ne-	45	D1	C1	C11	C21	11	21	31	41																			
52	62	72	82	92	02	96	36	U1	R2	V2	Rct	Ge-	Szo	Ne+	46	C3	C13			12	22	32	42																		
54	64	74	84	94	04	98	38	U2		V1	Gzo	Szo	Gzi	Rca	48	D2	C2	C12	C22	14	24	34	44																		
Q5...Q10 Ekip Signalling 4K						S51 S33 M YR				Trip Unit I/O				Module		Module		Module		Ekip Supply		TU I/O		RTC		YU Y02		YC		YO		YC2		Q1		Q2		Q3		Q4	

11	21	31	41
12	22	32	42
14	24	34	44
Q1	Q2	Q3	Q4

81) Open/closed auxiliary contacts of circuit breaker - AUX 4Q (4 Form C)

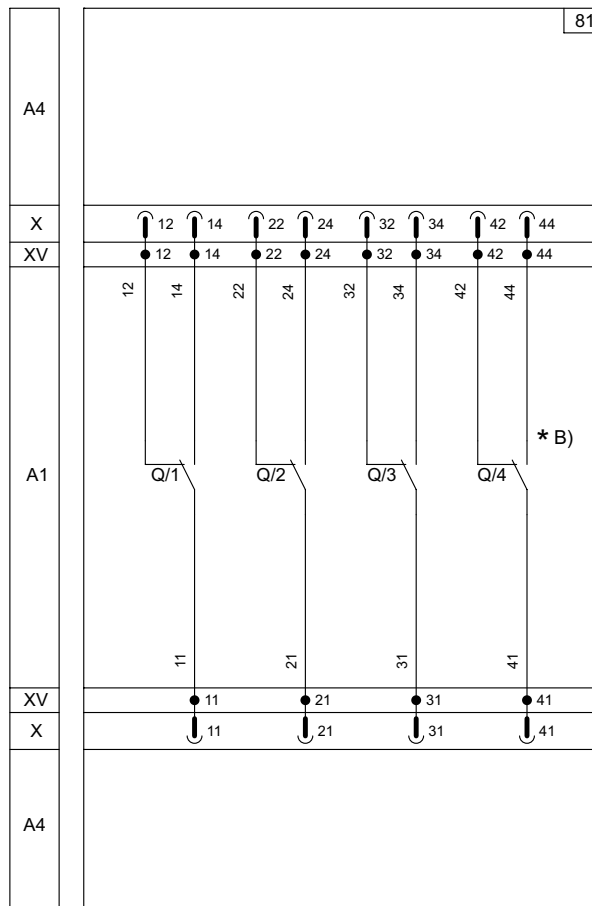

1SDC200039D0201



75) First shunt trip - YO

76) First shunt trip with control from protection trip unit - YO, Ekip Com Actuator

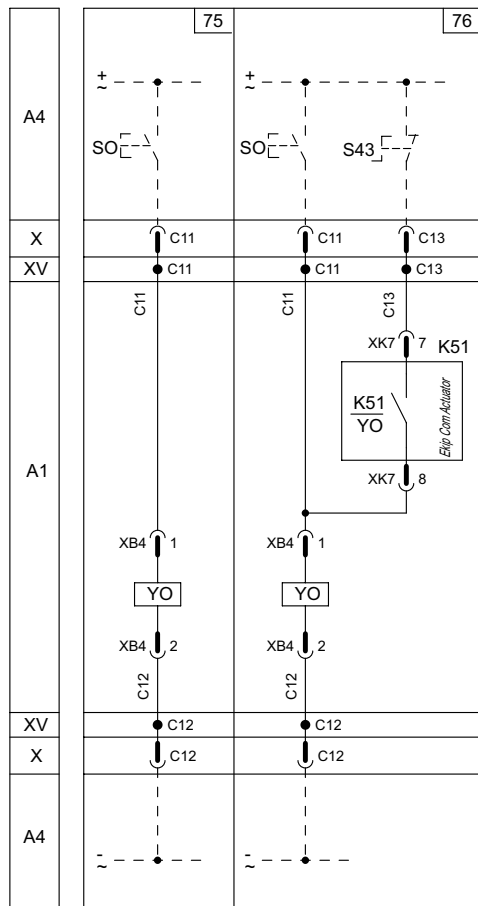

75-76 as an alternative to each other

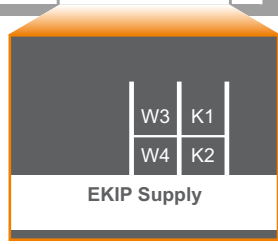

32) Auxiliary supply through module 110-240V AC/DC or 24-48V DC and local bus - Ekip Supply

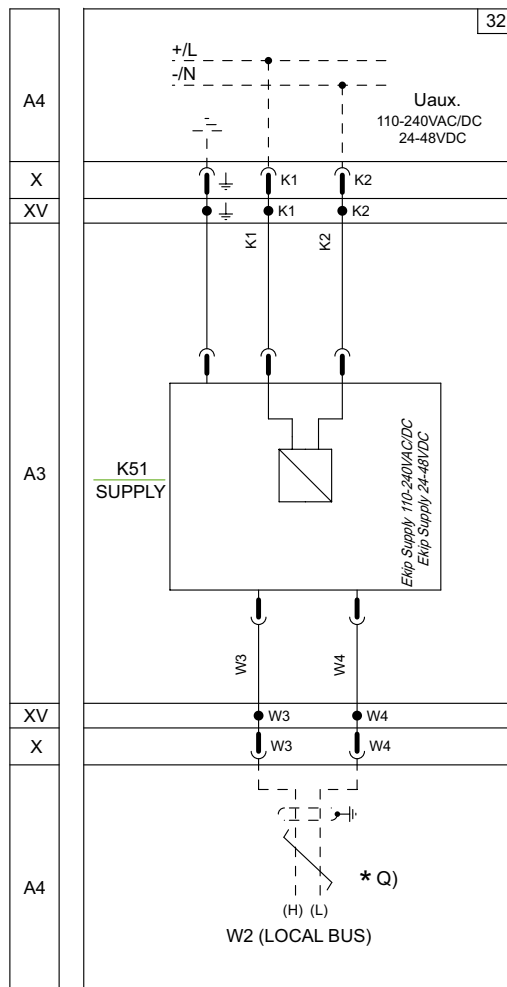

* I)

As an alternative to figures 31-33

Electrical diagrams

Electrical accessories



31) Direct auxiliary supply 24V DC and local bus - Ekip Supply

8

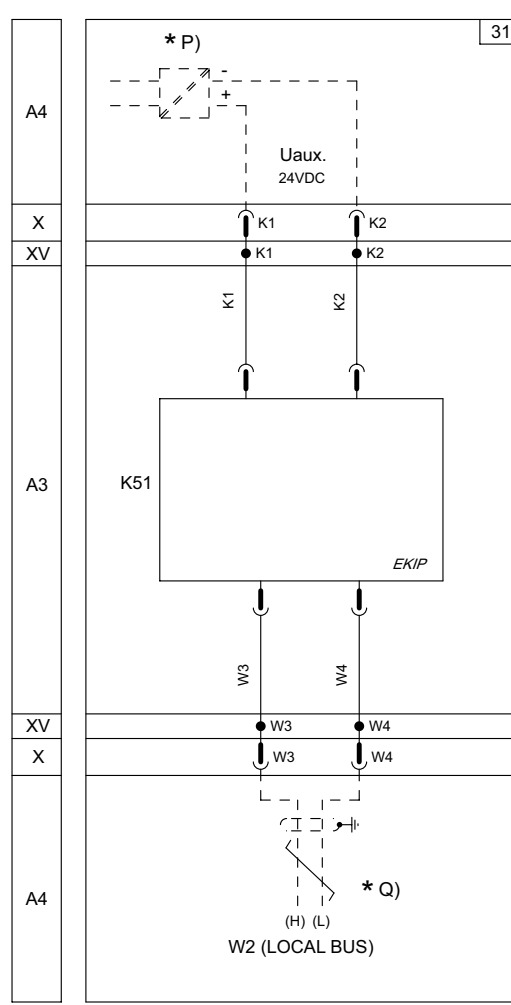

As an alternative to figures 32-33

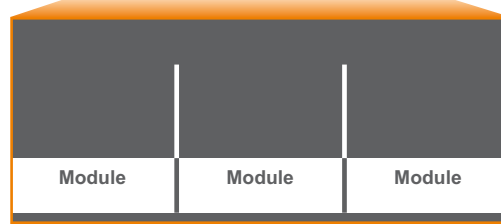
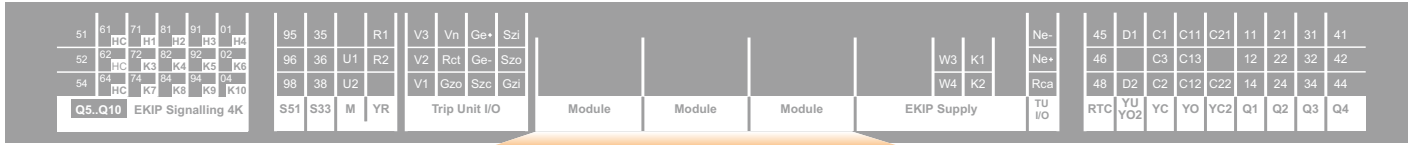

- 41) Ekip Signalling 2K-1
- 42) Ekip Signalling 2K-2

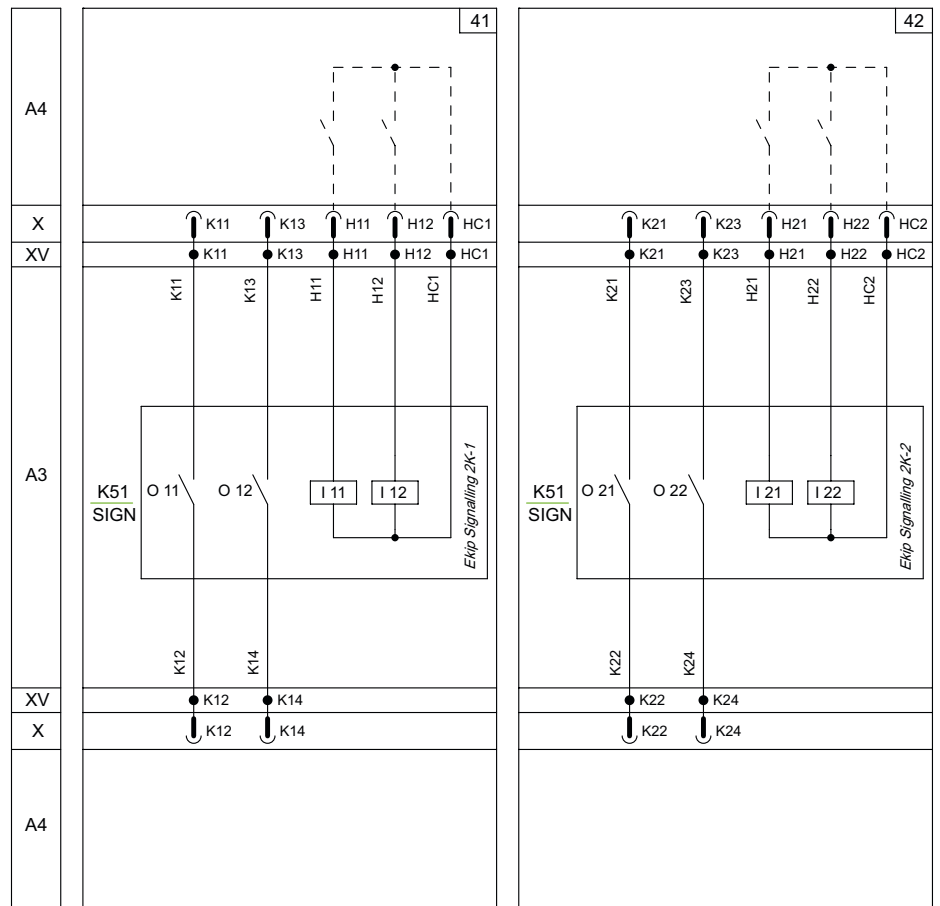

* L), * M), * N)

* L), * M), * N)

Electrical diagrams

Electrical accessories

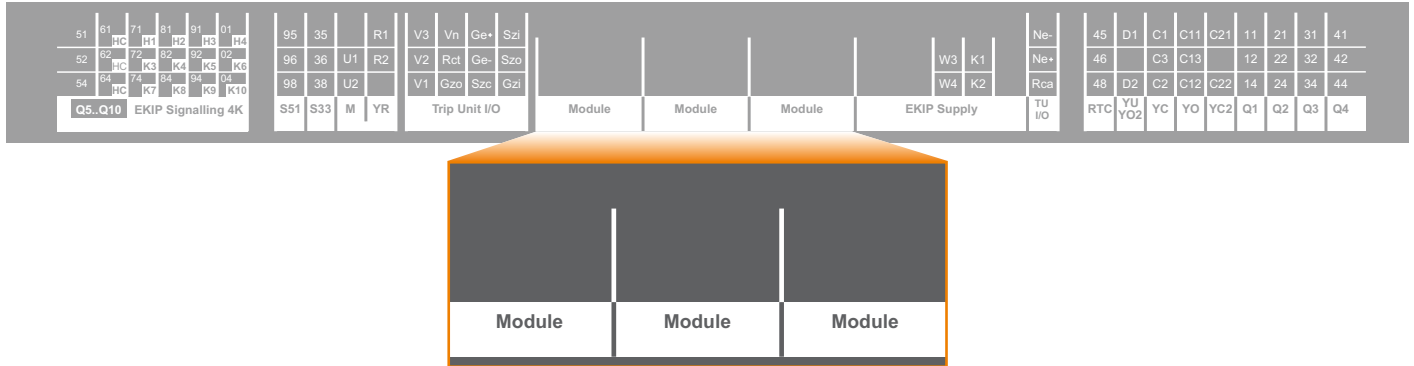

- 43) Ekip Signalling 2K-3
- 48) Ekip Synchrocheck

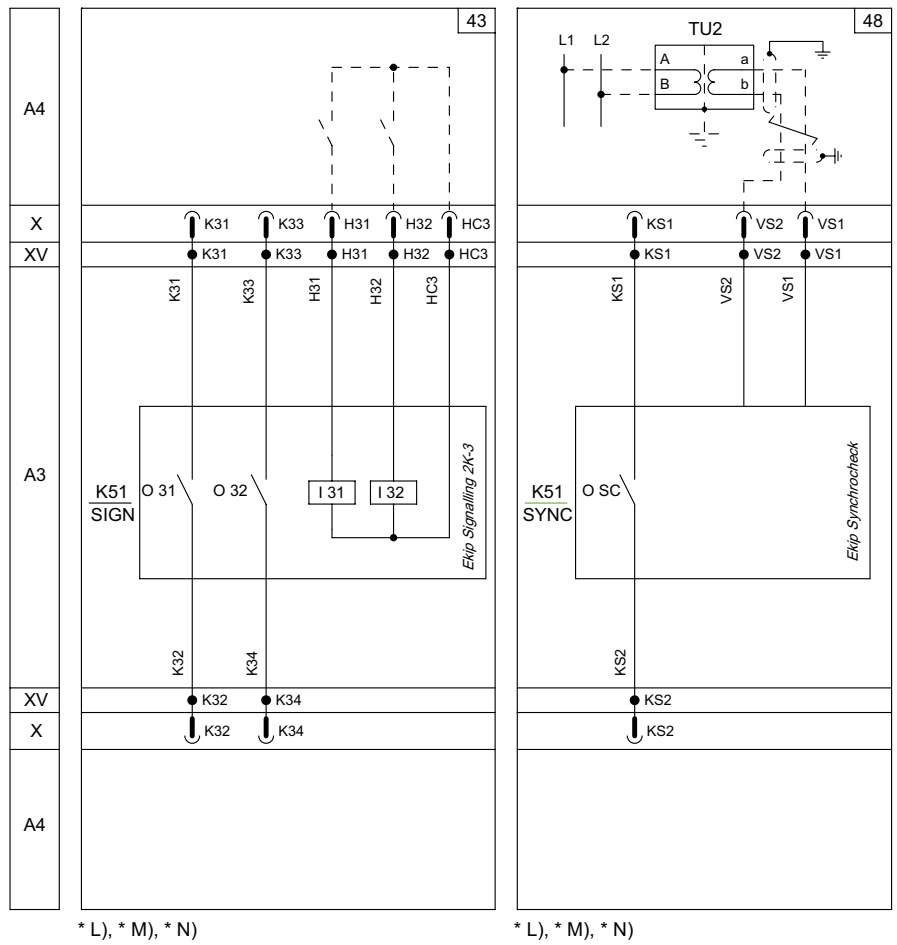

1SDC200634F001

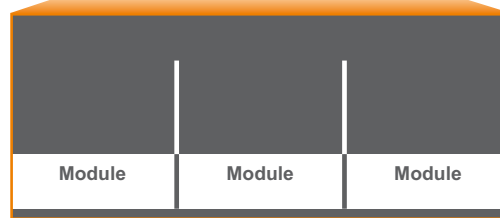
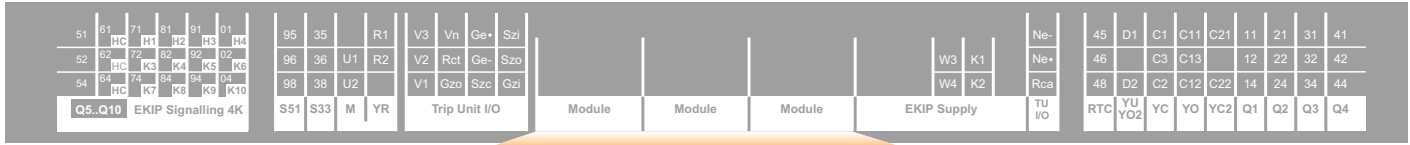

- 51) Ekip Com Modbus RS-485
- 52) Ekip Com Modbus TCP
- 53) Ekip Com Profibus

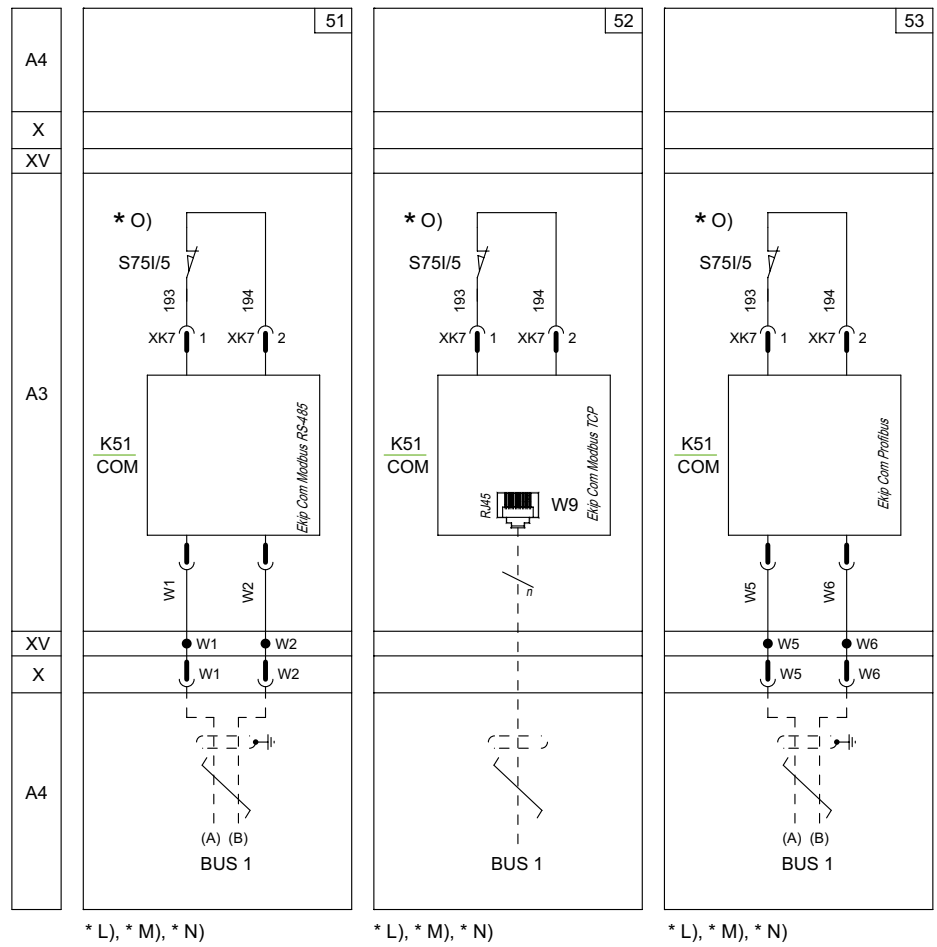

Electrical diagrams

Electrical accessories

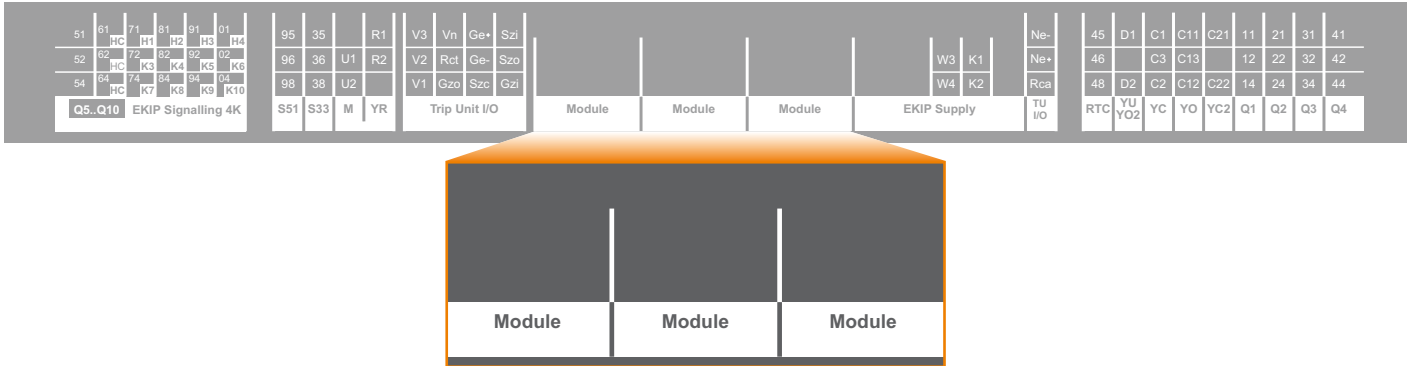

- 54) Ekip Com Profinet
- 55) Ekip Com DeviceNet
- 56) Ekip Com EtherNet/IP

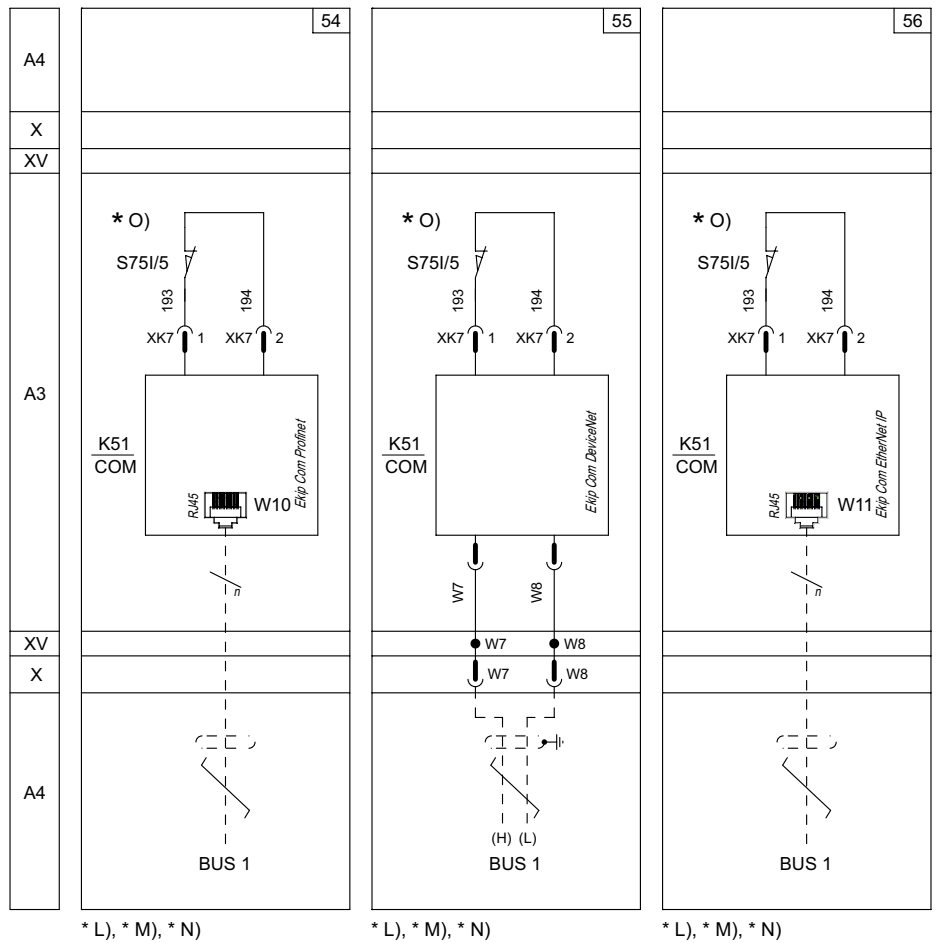

1SDC200039D0201

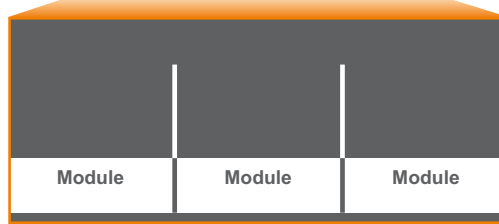
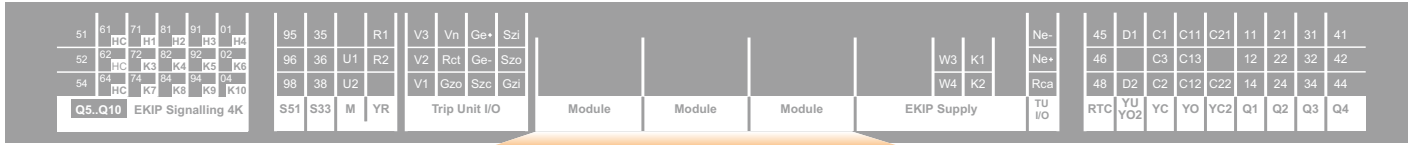

- 57) Ekip Com IEC61850
- 58) Ekip Link

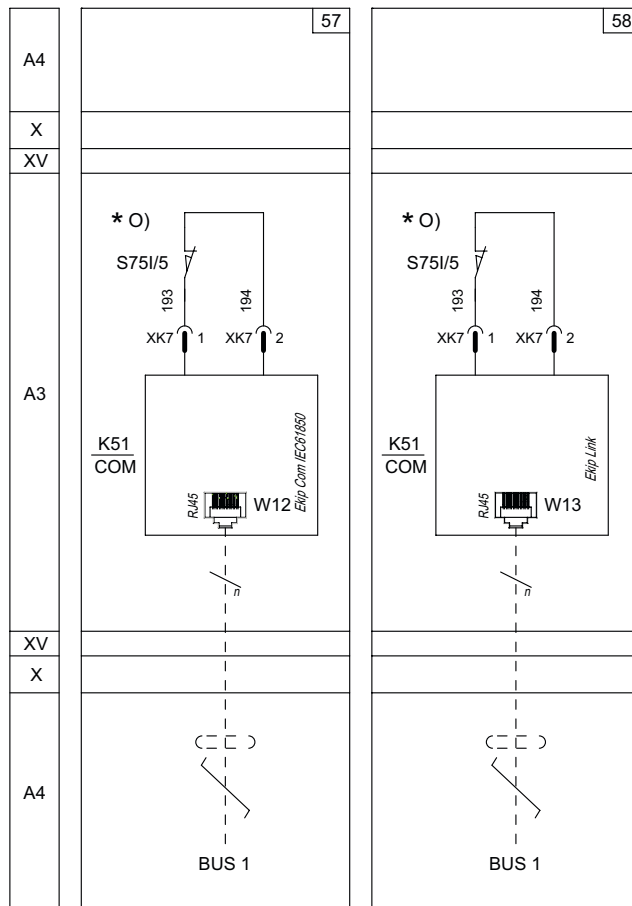

* L), * M), * N)

* L), * M), * N)

1SDC200637F001

Electrical diagrams

Electrical accessories

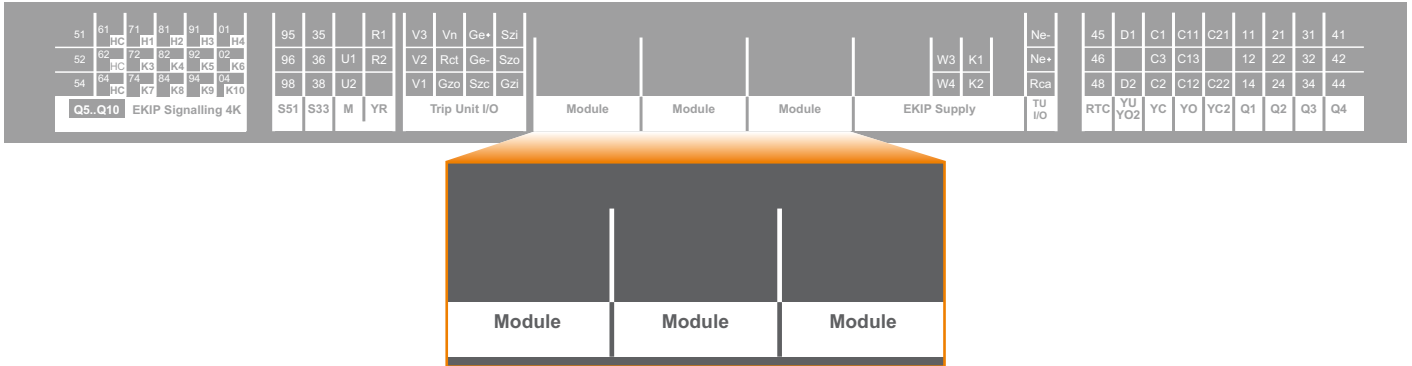

- 61) Ekip Com R Modbus RS-485 Redundant
- 62) Ekip Com R Modbus TCP Redundant
- 63) Ekip Com R Profibus Redundant

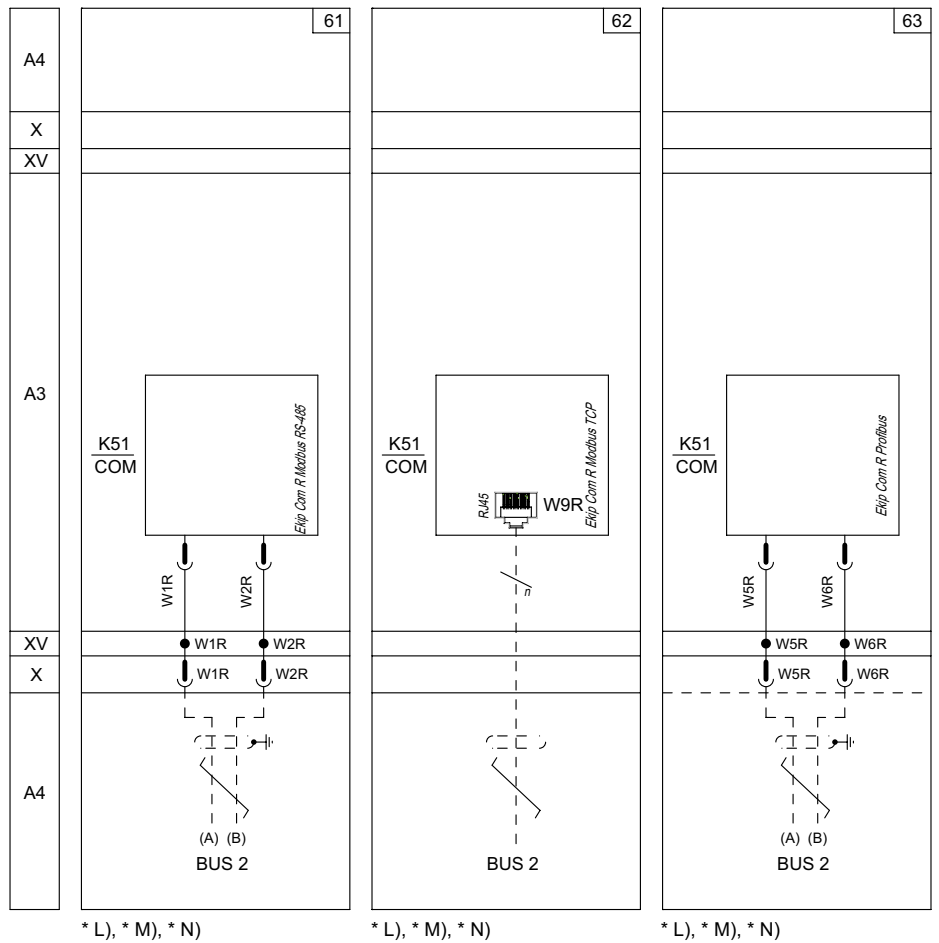

1SDC20039D0201

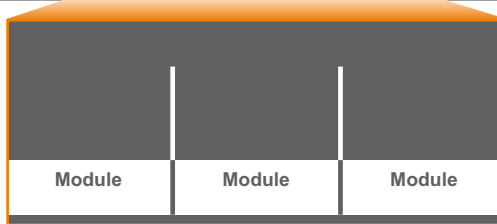
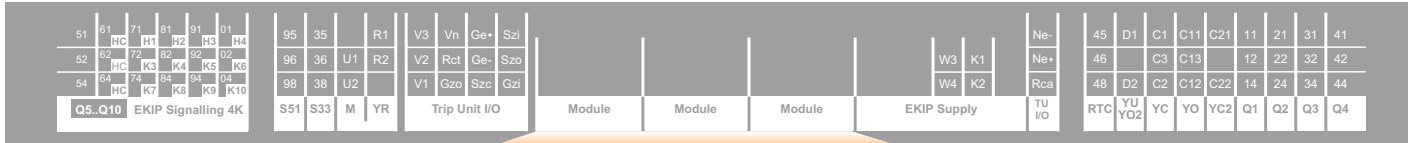

- 64) Ekip Com R ProfiNet Redundant
- 65) Ekip Com R DeviceNet Redundant
- 66) Ekip Com R EtherNet/IP Redundant

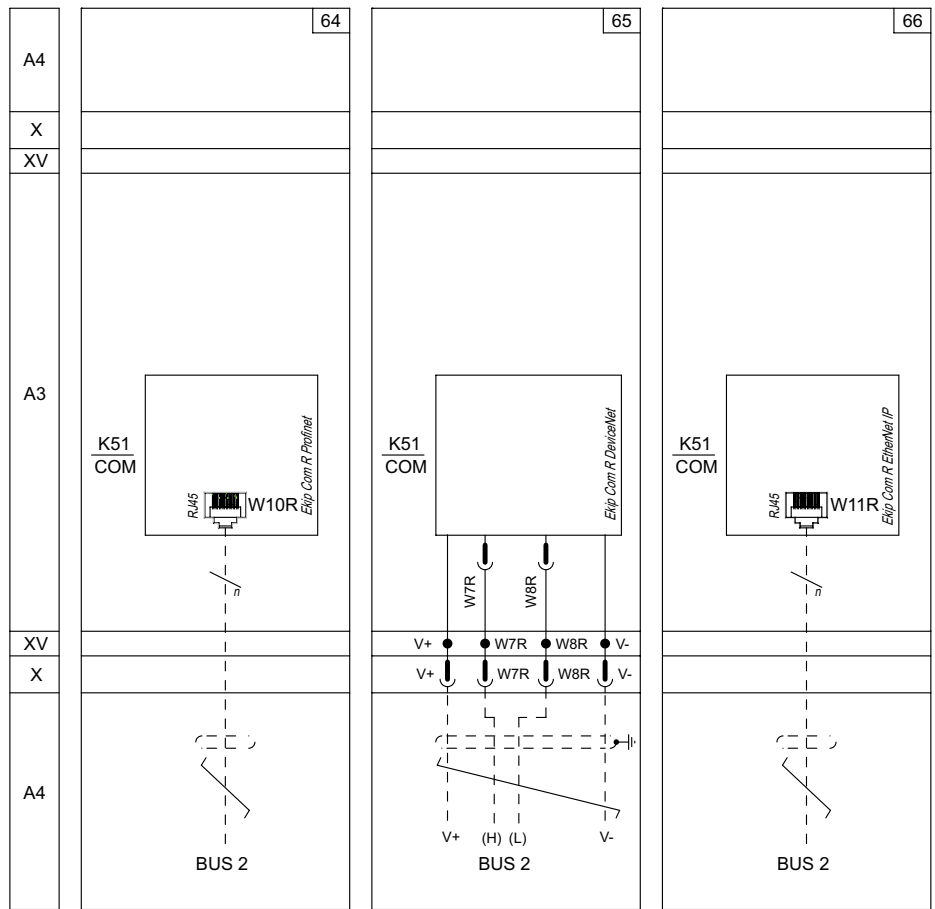

* L), * M), * N), * R)

* L), * M), * N)

, * L), * M), * N), * R)

1SDC20039D001

Electrical diagrams

Electrical accessories

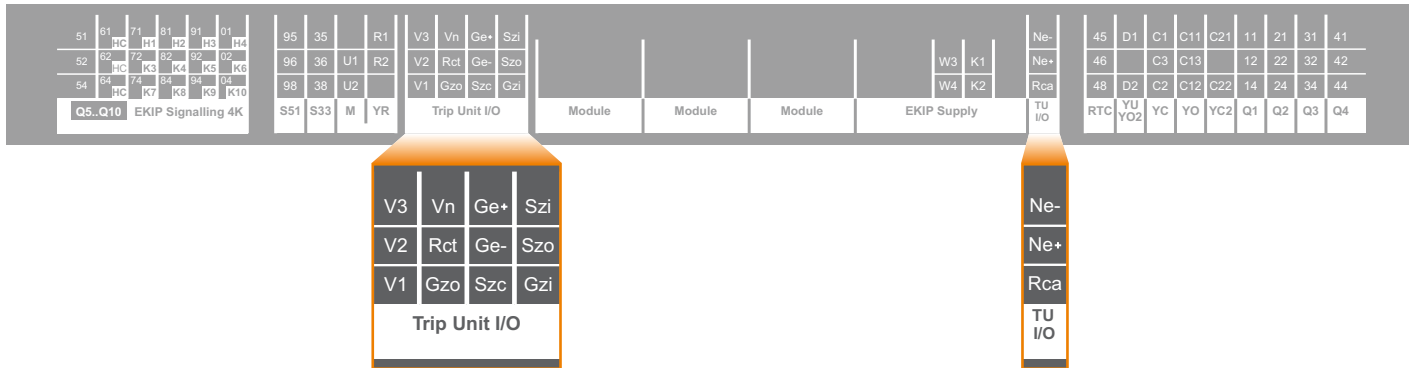

25) Transformer star center sensor input (homopolar toroid for the earthing conductor of main power supply)

27) Current sensor input for external neutral (only for 3-pole circuit breakers)

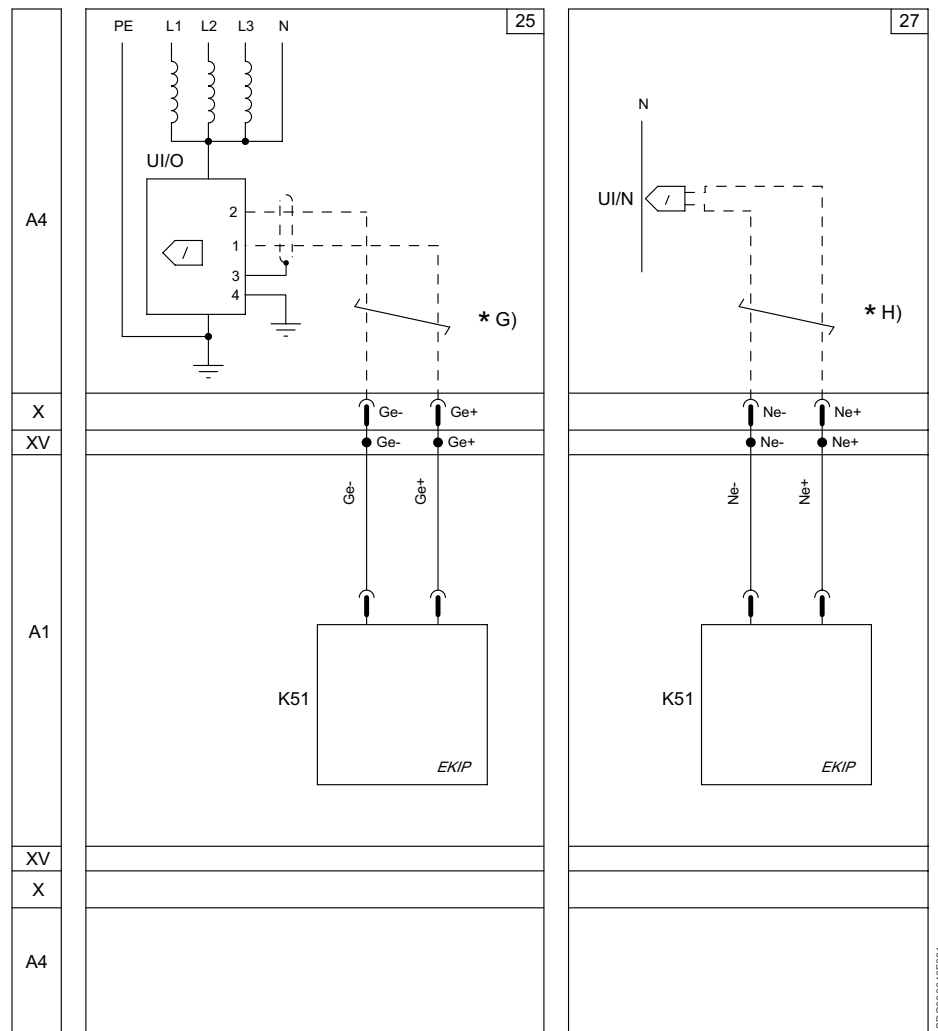

As an alternative to figure 24



24) Rc residual current protection sensor input (ANSI 64 & 50NTD)
 24a) Rc differential ground fault protection (ANSI 87N)

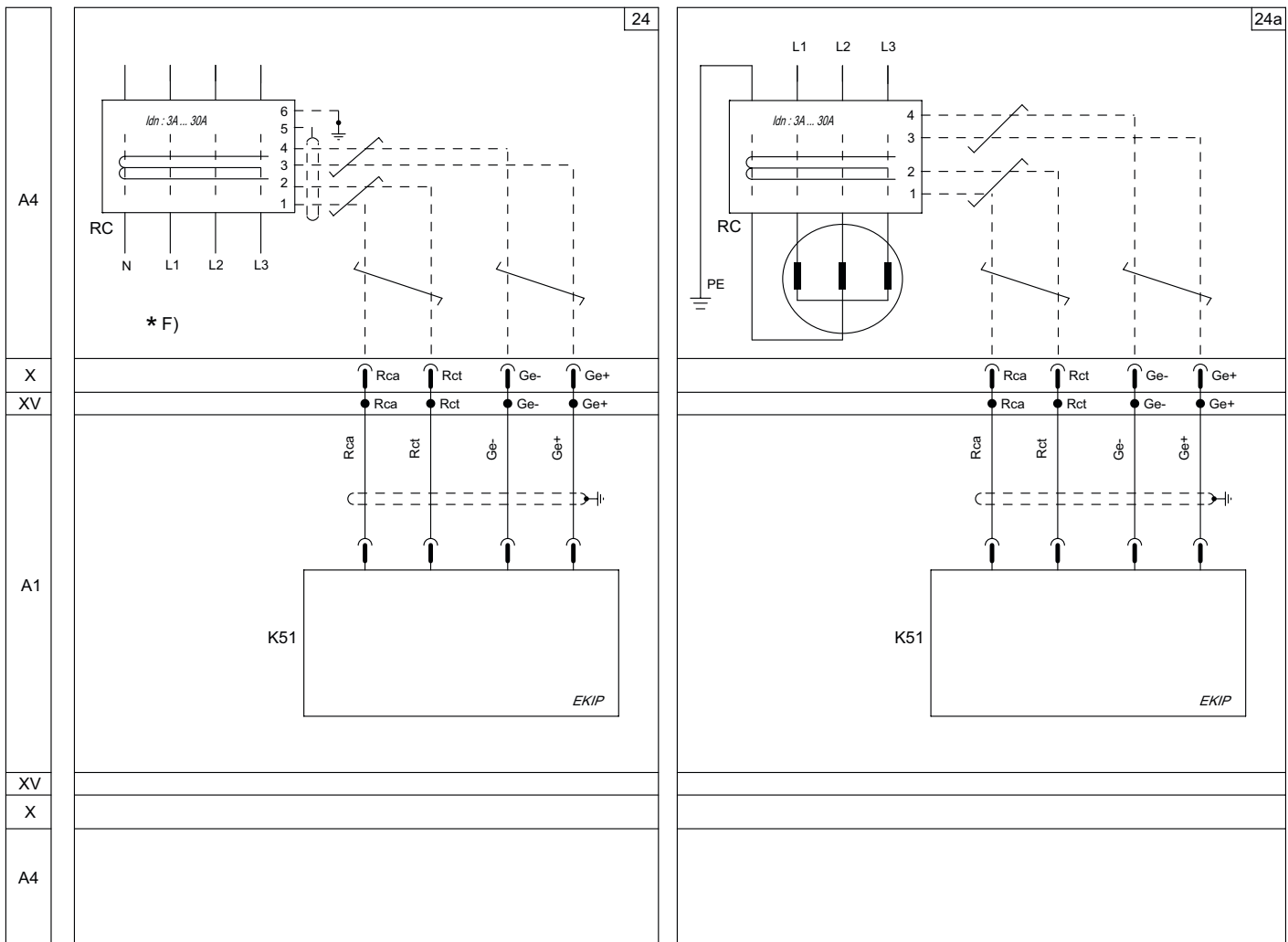

As an alternative to figure 25

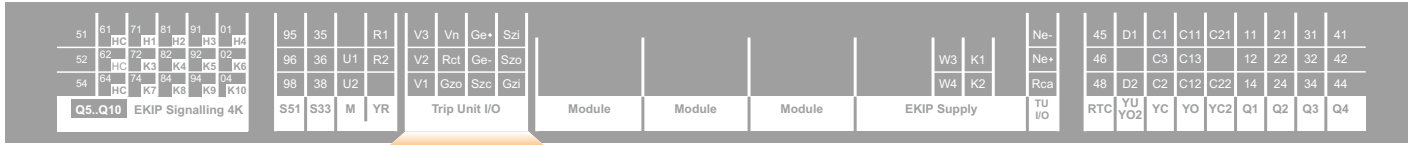

- 20) Ekip Measuring/Measuring Pro with voltage socket inside the four pole circuit breaker
- 21) Ekip Measuring/Measuring Pro with voltage sockets inside the three-pole circuit breaker and connection to the external neutral

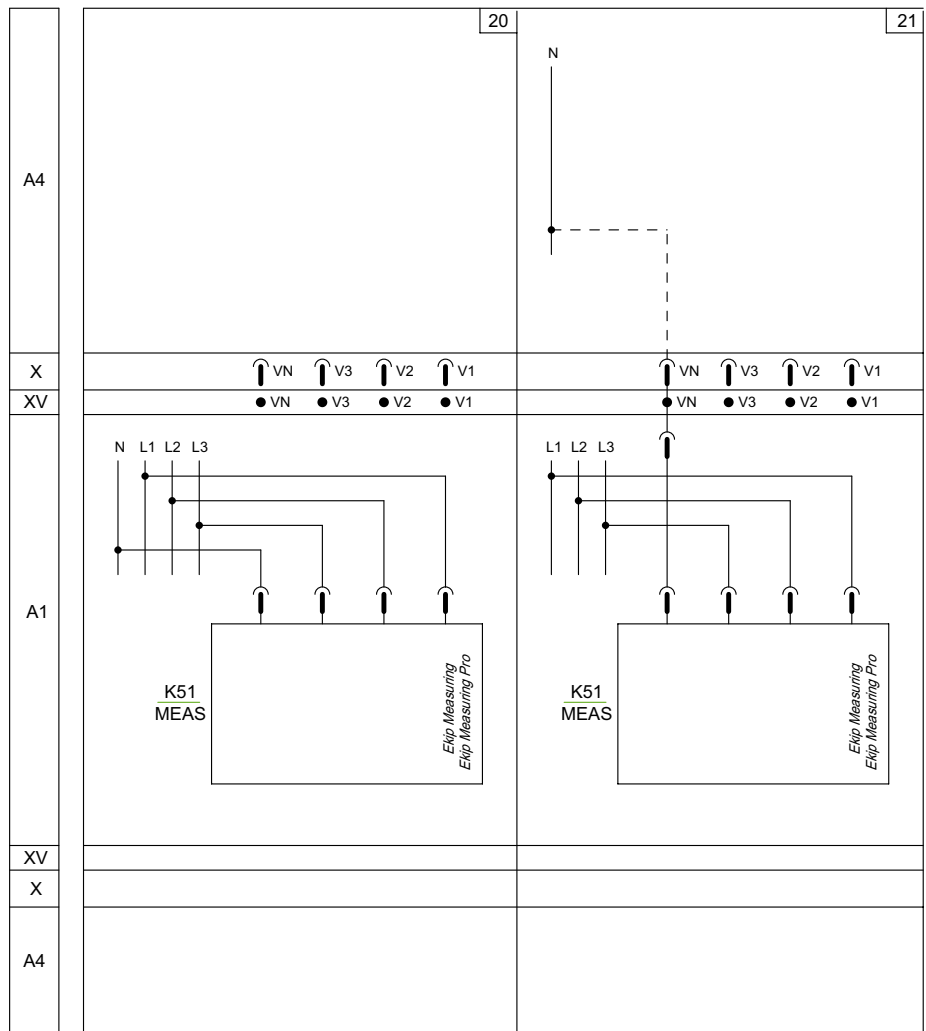

As an alternative to each other or to 22-23 diagram

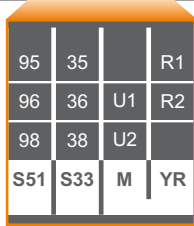

- 11) Trip signalling contact - S51 (bell alarm)
- 12) Contact for signalling position of loaded springs - S33 M/2
- 13) Motor for loading closing springs - M
- 14) Remote reset – YR

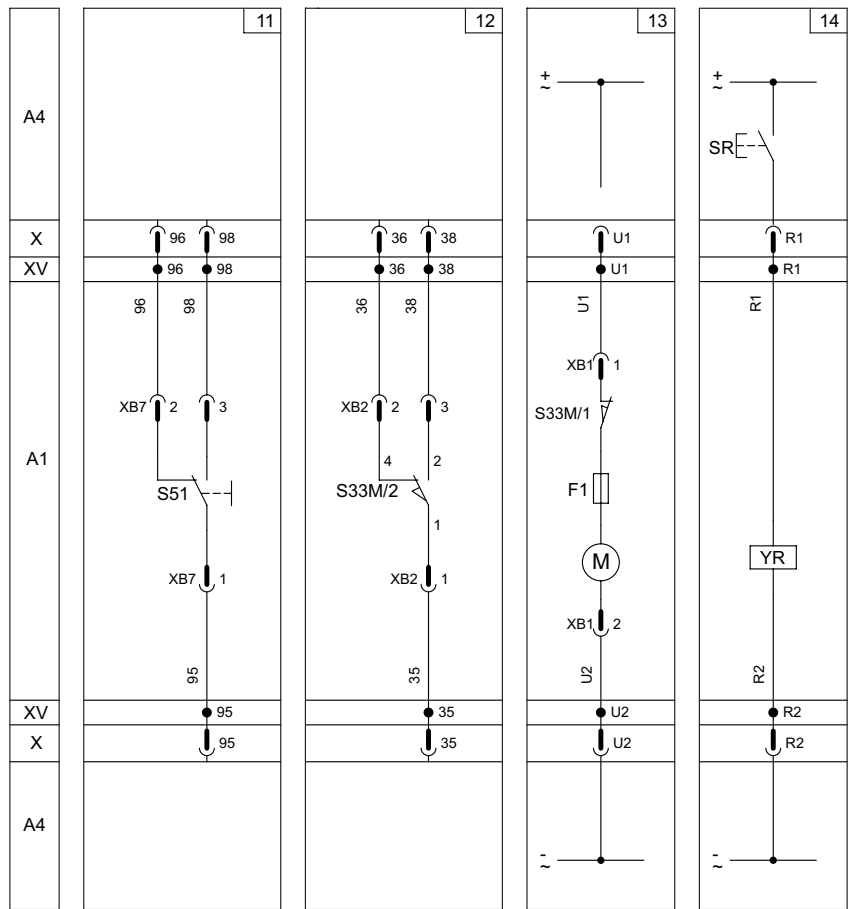

* D)

1SDC200645F001

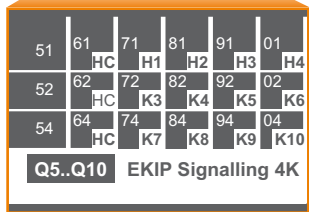

1) Supplementary open/closed auxiliary contacts of the circuit breaker - AUX 6Q (6 Form C)

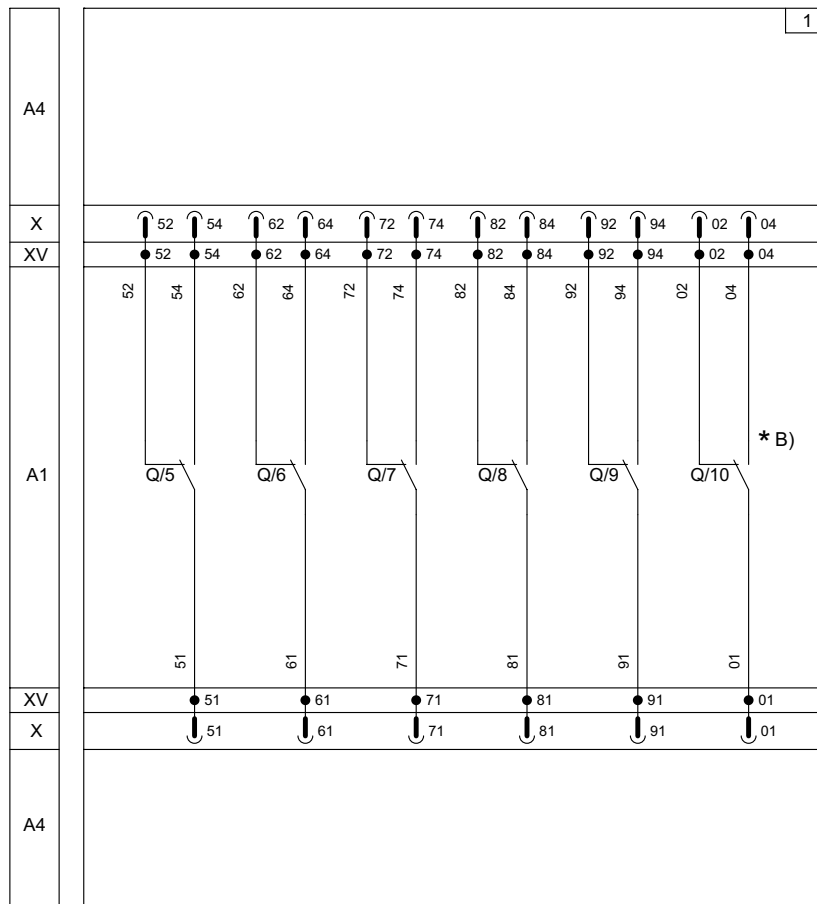

Only for E2.2, E4.2 and E6.2 circuit breakers (as an alternative to figure 2)

Electrical diagrams

Electrical accessories

91) Supplementary open/closed auxiliary contacts outside the circuit breaker - AUX 15Q (15 Form C)

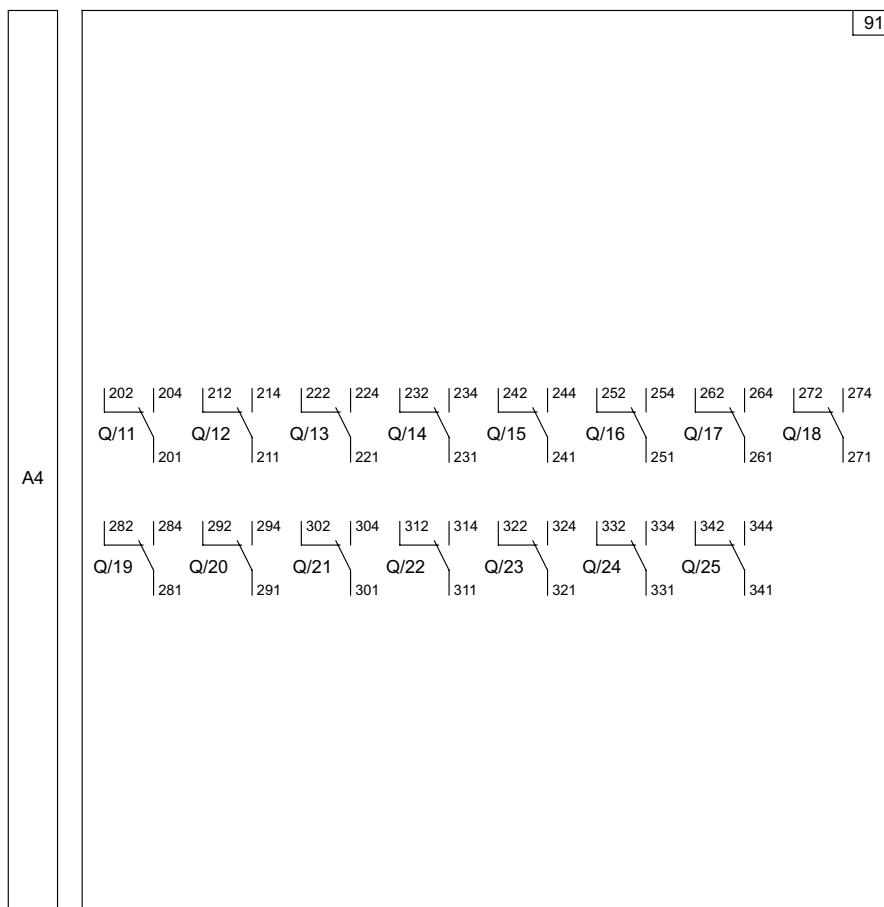

1SDC20064R001

95) Auxiliary position contacts - AUP (E1.2)

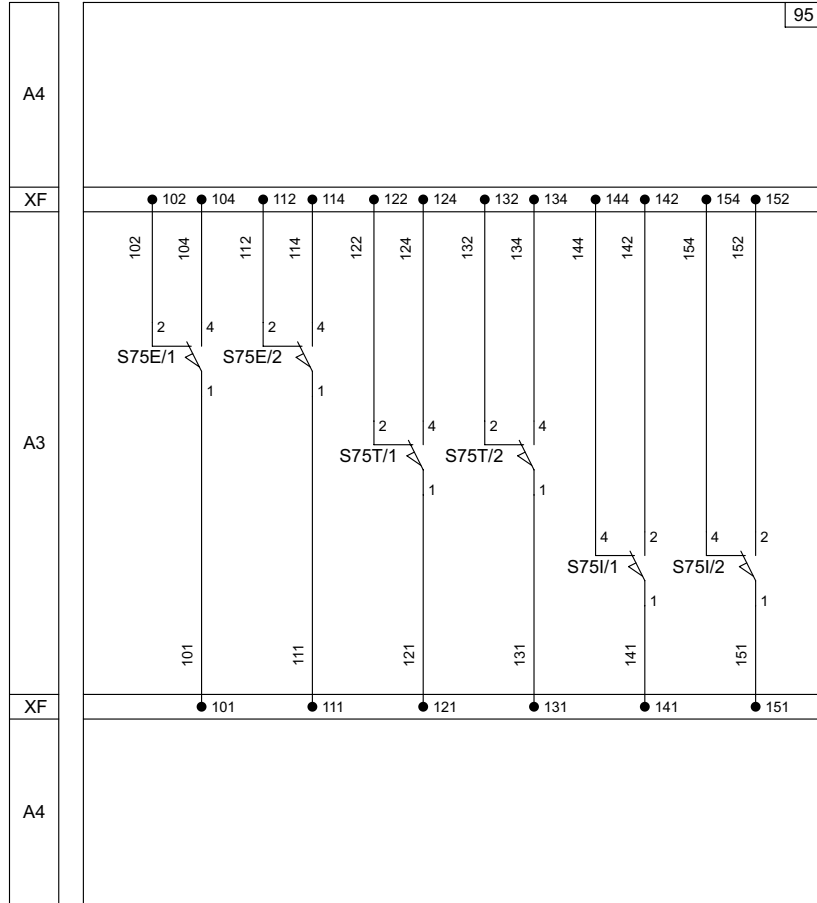

Only for E1.2 circuit breakers in a drawout version

Electrical diagrams

Electrical accessories

96) Auxiliary position contacts - AUP (E2.2 - E6.2)

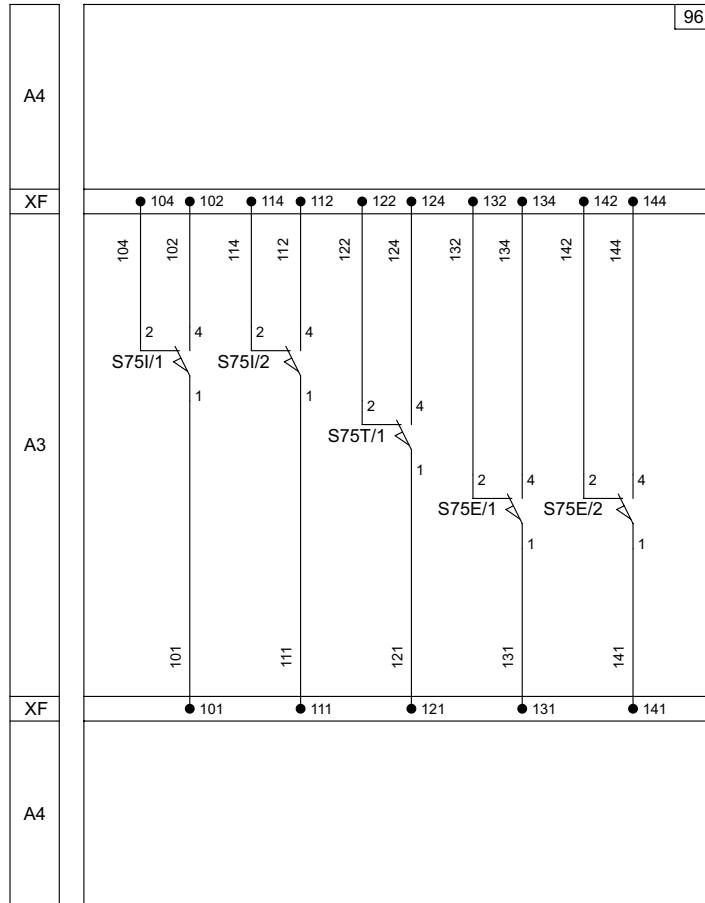

Only for E2.2, E4.2 and E6.2 circuit breakers in a drawout version

97) Supplementary auxiliary position contacts - AUP (E2.2 - E6.2)

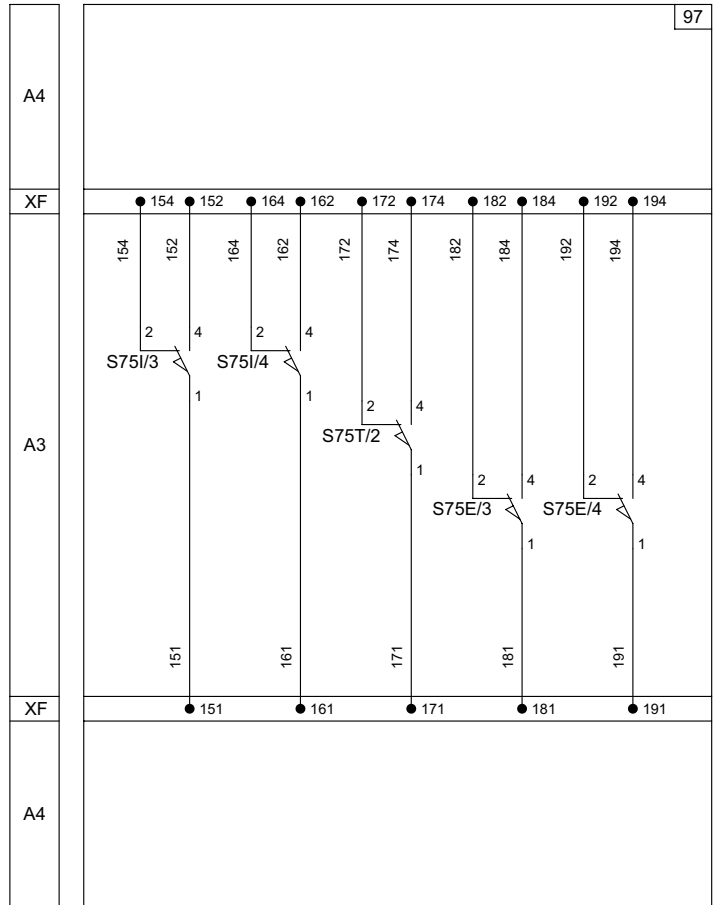

Only for E2.2, E4.2 and E6.2 circuit breakers in a drawout version

Electrical diagrams

ATS021 and ATS022 (IEC only)

98) ATS wiring with no auxiliary power supply

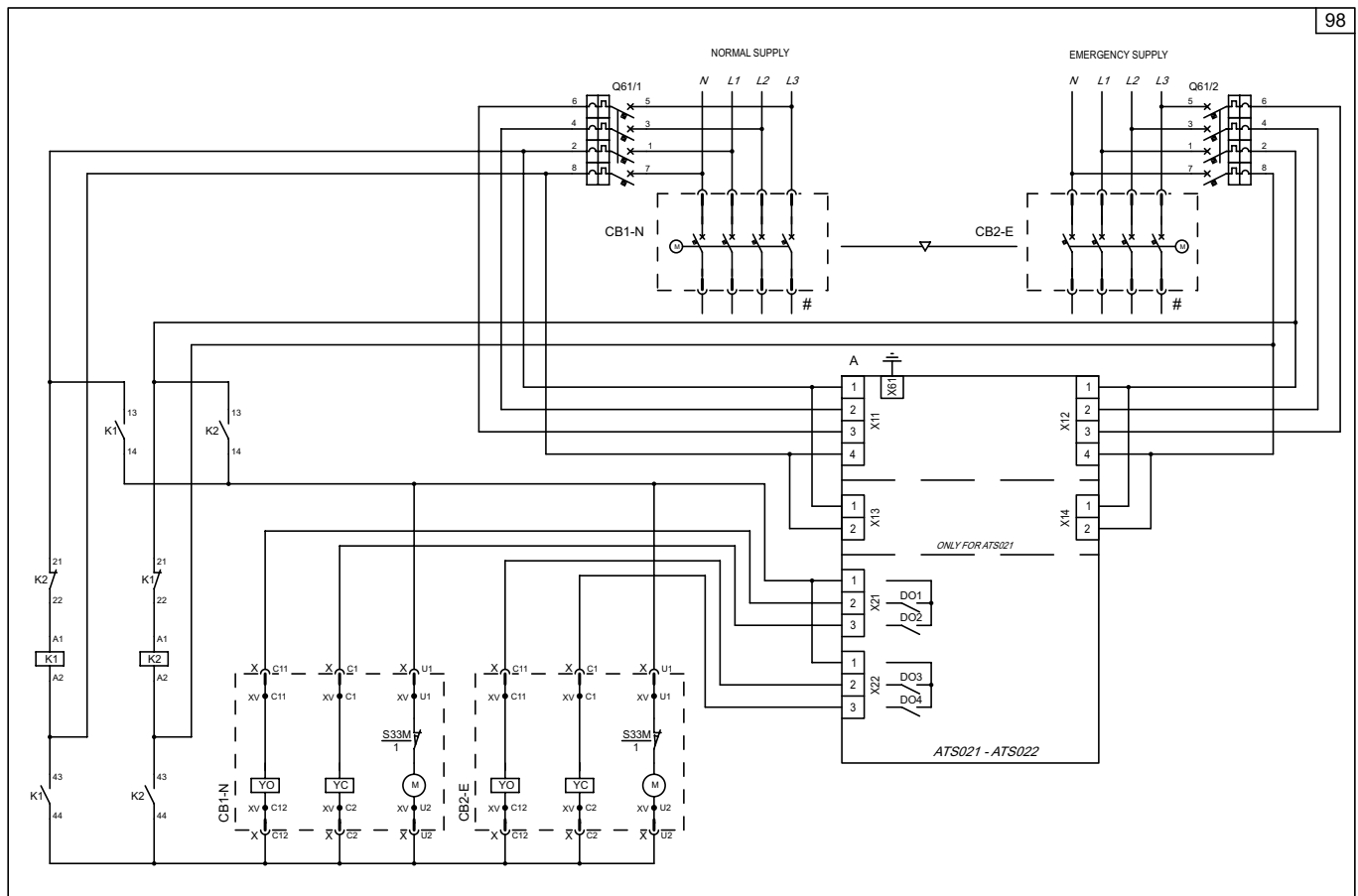

98

8

1SDC200065GENE001

99) Circuit breakers with auxiliary safety voltage in direct current

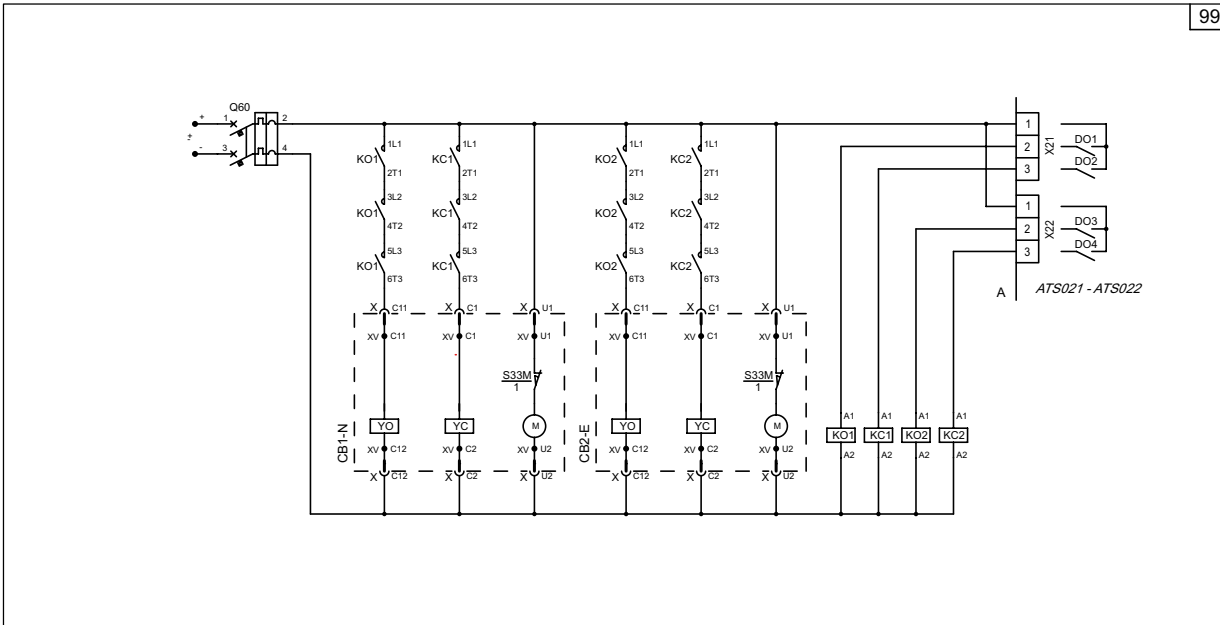

99) Circuit breakers with auxiliary safety voltage in alternating current

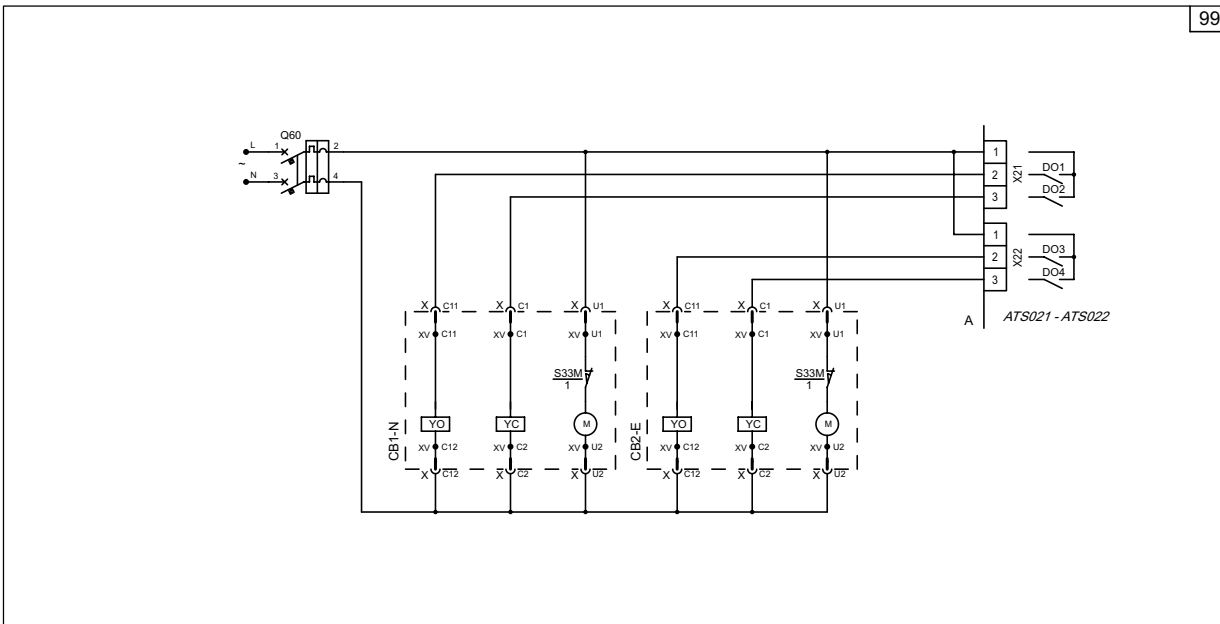

Electrical diagrams ATS021 and ATS022 (IEC only)

100) ATS021 (IEC only)

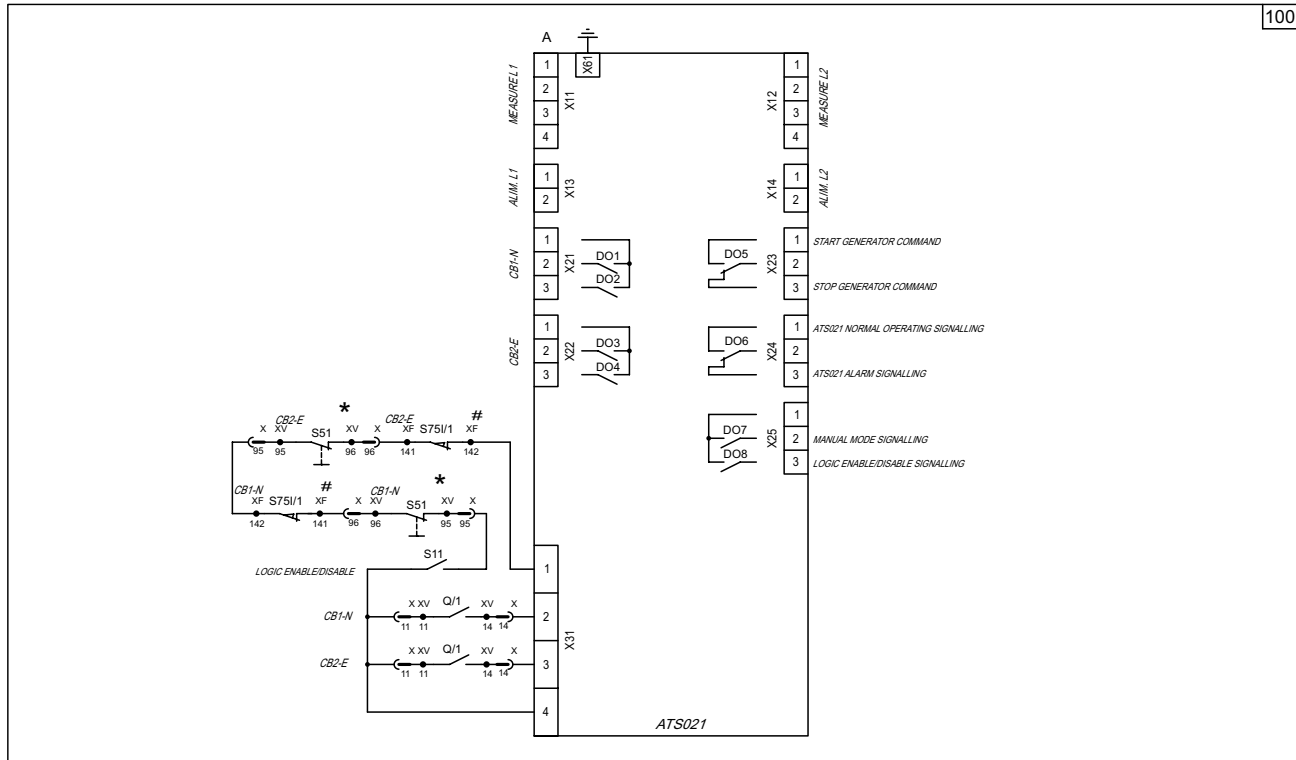

101) ATS022 (IEC only)

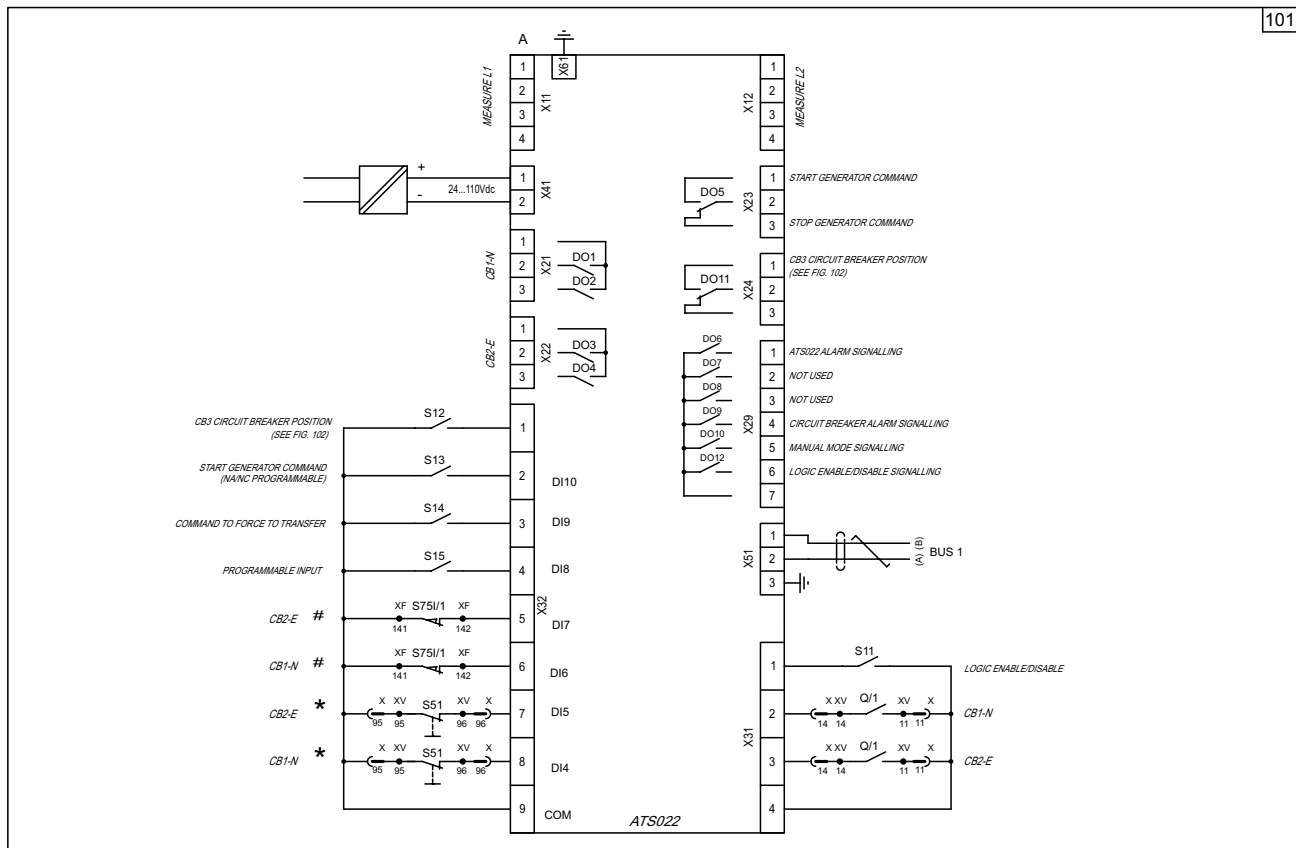

102) Controlling a third circuit breaker with ATS022 (IEC only)

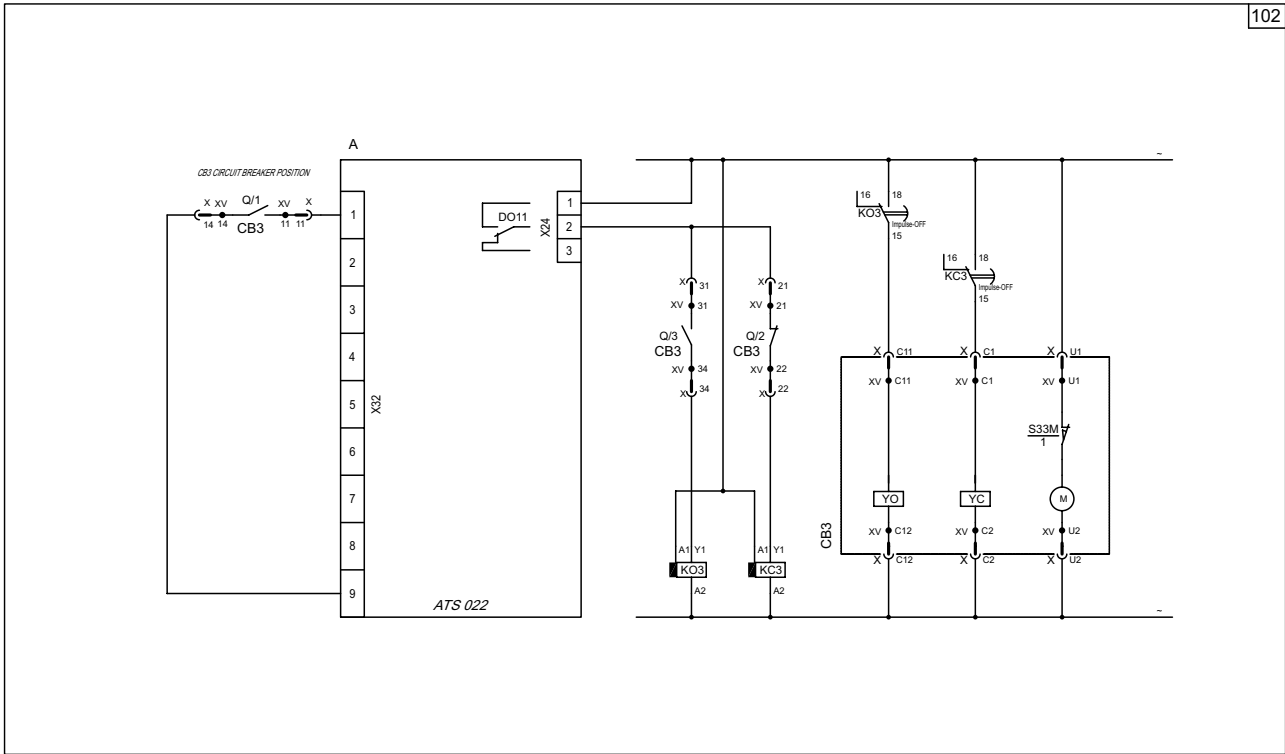

1SDC200654ENF001

Possible configurations - ATS022 (IEC only) with three circuit breakers

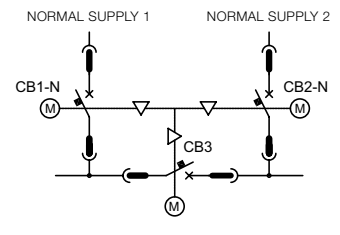
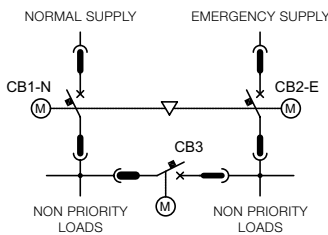
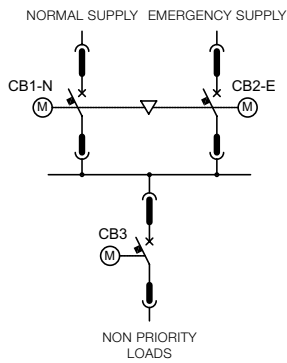

Note: Use auxiliary voltage of 110-130V AC or 220-240V AC.

Electrical diagrams

Power Controller

103) Ekip Signalling 10K

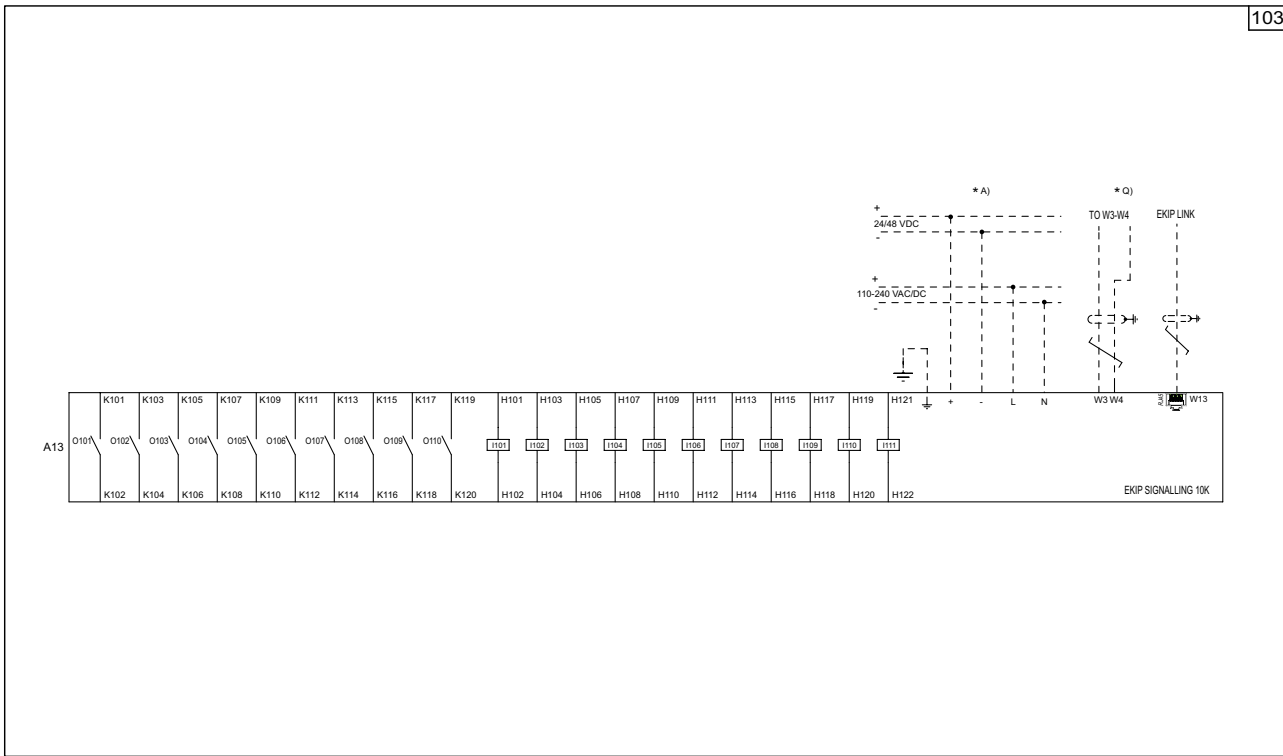

1SDC200655F001

8

104) Ekip Multimeter

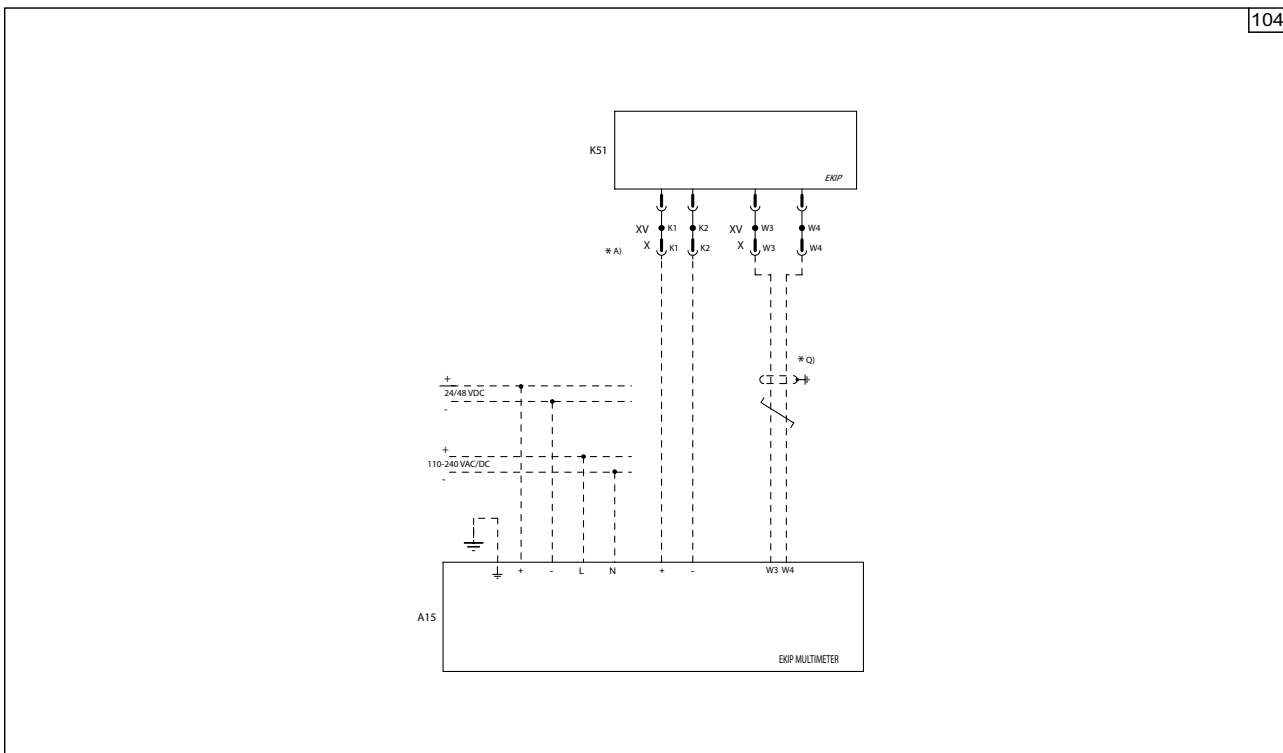

1SDC200656F001

105) Application diagram for Ekip Touch, Hi-Touch, G Touch, G Hi-Touch with Power Controller function

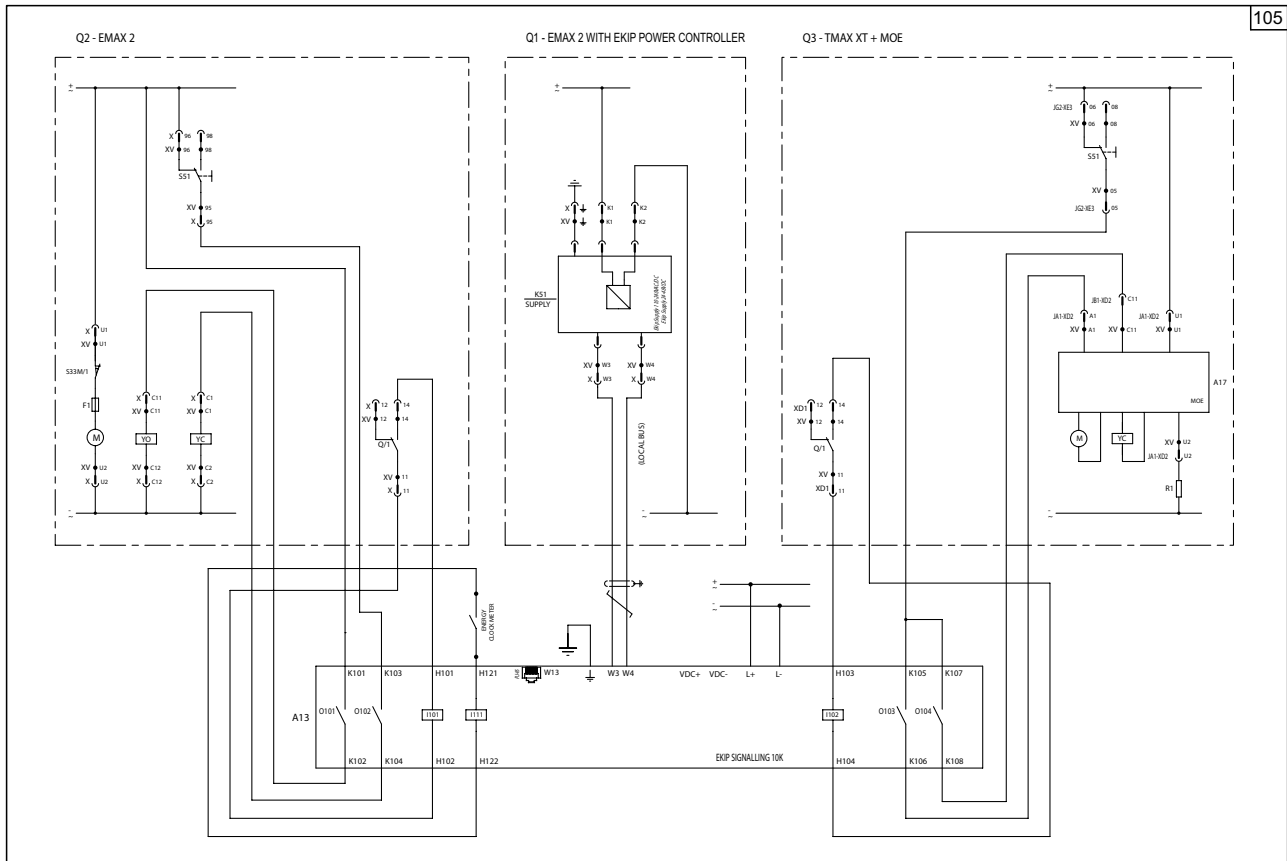
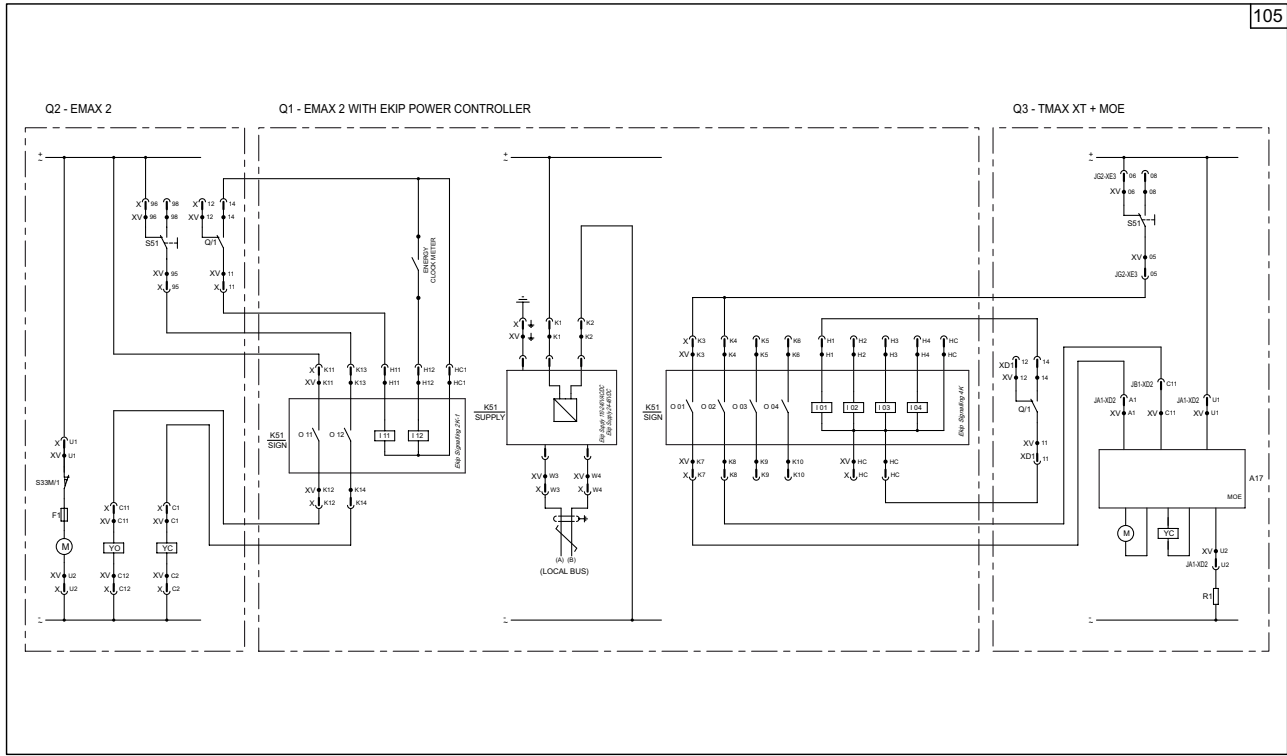

Electrical diagrams

Power Controller

105) Application diagram for Ekip Touch, Hi-Touch, G Touch, G Hi-Touch with Power Controller function

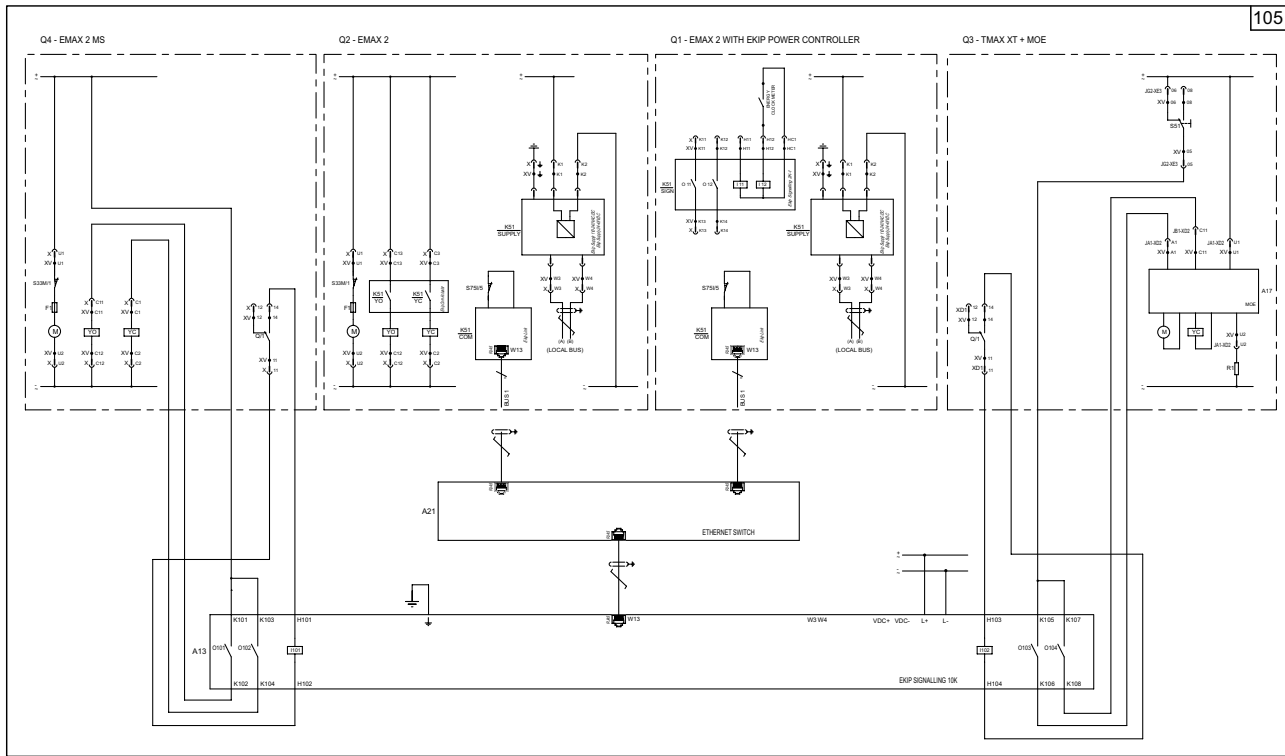

Ordering Global codes

Instructions for ordering

Ordering examples 9/2

General information

9/4

Automatic circuit breakers

Fixed version for power distribution 9/5

Drawout version for power distribution 9/19

Fixed version for generators 9/33

Drawout version for generators 9/38

Switch disconnectors

Fixed version 9/43

Drawout version 9/45

Cradles

9/47

Accessories

Electrical accessories 9/48

Mechanical accessories 9/51

Mechanical interlock 9/54

Ekip modules 9/55

Terminals 9/58

Instructions for ordering

Ordering examples

Standard version Emax 2 series circuit breakers are identified by codes that can be accessorized.

Ordering examples

– **Terminal kit** codes (other than standard supply) for fixed circuit breakers or cradles.

The codes refer to 3 or 4 pieces for mounting on either the top or bottom terminals.

To convert a complete circuit breaker, 1 kit for upper terminals and 1 kit for lower terminals must be specified on the order.

Example no. 1

Emax E2.2N 3 poles fixed with vertical rear terminals (VR)

1SDA077293R1	E2.2N-A 2000 Ekip Touch LSIG 3p F HR
1SDA079852R1	Kit VR Upper E2.2 lu=2000 3pcs INST
1SDA079854R1	Kit VR Lower E2.2 lu=2000 3pcs INST

Example no. 2

Emax E1.2N 4 poles fixed with upper vertical rear (VR) and lower front (F) terminals (standard supply)

1SDA077020R1	E1.2N-A 1200 Ekip Dip LSIG 4p F F
1SDA079837R1	Kit VR Upper E1.2 lu=1200 4pcs INST

– **Rating plug for lower rated current values.**

Rating plugs installed on the circuit breaker allow for rated current values that are lower than the rated current of the circuit breaker.

Example no. 3

Emax E2.2S 2000 3 poles fixed In=1000A

1SDA077333R1	E2.2S-A 2000 Ekip Touch LSIG 3p F HR
1SDA074264R1	Rating Plug 1000A E1.2...E6.2 INST

– **Ordering Ekip modules.**

The Ekip Supply module enables Ekip Com, Ekip Link, Ekip 2K and Ekip Synchrocheck modules to be installed.

In addition to the Ekip Supply module, up to 3 additional modules can be installed on E2.2, E4.2 and E6.2 and up to 2 additional modules on E1.2.

Example no. 4

Emax E4.2H 3 poles fixed with modules: Ekip Supply, Ekip Com Modbus TCP, Ekip Signalling 2K, Ekip Com Modbus RCP Redundant and Ekip Signalling 4K

1SDA077926R1	E4.2H-A 3200 Ekip Hi-Touch LSIG 3p F HR
1SDA074173R1	Ekip Supply 24-48V DC E1.2..E6.2
1SDA074151R1	Ekip Com Modbus TCP E1.2..E6.2
1SDA074158R1	Ekip Com R Modbus TCP E1.2..E6.2
1SDA074167R1	Ekip Sign. 2K-1 E1.2..E6.2
1SDA074170R1	Ekip Sign. 4K E2.2..E6.2

Example no. 5

Emax E4.2H 3 poles fixed with modules: Ekip Supply, Ekip Com EtherNet/IP, Ekip Com Modbus RS-485 and Ekip Measuring Pro

1SDA077923R1	E4.2H-A 3200 Ekip Touch LSIG 3p F HR
1SDA074173R1	Ekip Supply 24-48V DC E1.2..E6.2
1SDA074155R1	Ekip Com EtherNet/IP E1.2..E6.2
1SDA074150R1	Ekip Com Modbus RS-485 E1.2..E6.2
1SDA074189R1	Ekip Measuring Pro E4.2

Example no. 6

Emax E1.2N 4 poles fixed with modules: Ekip Supply and Ekip Link

1SDA077020R1	E1.2N-A 1200 Ekip Dip LSIG 4p F F
1SDA074172R1	Ekip Supply 110-240V AC/DC E1.2..E6.2
1SDA074163R1	Ekip Link E1.2..E6.2

– Ordering for electrical accessories.

Example no. 7

Emax E2.2S 3 poles drawout with accessories: shunt trip, closing coil, motor and second shunt trip

1SDA077662R1	E2.2S-A 1600 Ekip Touch LSI 3p WMP
1SDA073674R1	YO E1.1..E6.2 220-240V AC/DC
1SDA073687R1	YC E1.2..E6.2 220-240V AC/DC
1SDA073725R1	M E2.2..E6.2 220-250V AC/DC
1SDA073674R1	YO E1.2..E6.2 220-240V AC/DC

– Ordering for locks.

Example no. 8

Emax E2.2N 3 poles with double key lock in racked in / test / racked out position, using different keys

1SDA077293R1	E2.2N-A 2000 Ekip Touch LSIG 3p F HR
1SDA073806R1	KLP-D Bl. Racked in/out E2.2..E6.2 1st key
1SDA073812R1	KLP-D Bl. Racked in/out E2.2..E6.2 2nd key

Abbreviations used for the description of the product

Versions and terminals

F	Fixed circuit breaker
W	Drawout circuit breaker
MP	Mobile part of drawout circuit breaker
FP	Fixed part (Cradle) of drawout circuit breaker
I_u	Rated uninterrupted current
I_n	Rated current of the rating plug
I_{cu}	Rated ultimate short-circuit breaking capacity
I_{cw}	Rated short-time withstand current
/MS	Switch disconnecter
/E	Circuit breakers for 1150V applications
/f	Four-pole circuit breakers with neutral pole at 100%
CS	Sectionalizing truck
MT	Earthing truck
MTP	Earthing switch with making capacity
HR VR	Rear orientable terminals
SHR	Horizontal rear spread terminals
SVR	Vertical rear spread terminals
F	Front terminals
FL	Flat terminals
EF	Extended front terminals
ES	Front spread terminals
Fc CuAl	Terminals for cables

Protection trip units and functions

Ekip Dip	Protection trip unit for power distribution
Ekip Touch	Measurement and protection trip unit for power distribution
Ekip Hi Touch	Measurement and protection trip unit and network analyzer for power distribution
Ekip G Touch	Measurement and protection trip unit for generators
Ekip G Hi-Touch	Measurement and protection trip unit and protection network analyzer for generators
L	Overload protection
S	Protection against selective short circuit
I	Protection against instantaneous short circuit
G	Earth fault protection
Rc	Residual current protection
Power Controller	Load management function

Automatic circuit breakers

Fixed version for power distribution



SACE Emax E1.2B-A/N-A • Front terminals (F)

Size	Frame Amps	Int. Rating (kA@508V)	Withstand (kA)	Type	3 Poles		4 Poles	
					Global code		Global code	
E1.2B-A	800	42	42	E1.2B-A 800 Ekip Dip LI	1SDA076908R1		1SDA076988R1	
				E1.2B-A 800 Ekip Dip LSI	1SDA076909R1		1SDA076989R1	
				E1.2B-A 800 Ekip Dip LSIG	1SDA076910R1		1SDA076990R1	
				E1.2B-A 800 Ekip Touch LI	1SDA076911R1		1SDA076991R1	
				E1.2B-A 800 Ekip Touch LSI	1SDA076912R1		1SDA076992R1	
				E1.2B-A 800 Ekip Touch LSIG	1SDA076913R1		1SDA076993R1	
				E1.2B-A 800 Ekip Hi-Touch LSI	1SDA076915R1		1SDA076995R1	
				E1.2B-A 800 Ekip Hi-Touch LSIG	1SDA076916R1		1SDA076996R1	
	1200	42	42	E1.2B-A 1200 Ekip Dip LI	1SDA076918R1		1SDA076998R1	
				E1.2B-A 1200 Ekip Dip LSI	1SDA076919R1		1SDA076999R1	
				E1.2B-A 1200 Ekip Dip LSIG	1SDA076920R1		1SDA077000R1	
				E1.2B-A 1200 Ekip Touch LI	1SDA076921R1		1SDA077001R1	
				E1.2B-A 1200 Ekip Touch LSI	1SDA076922R1		1SDA077002R1	
				E1.2B-A 1200 Ekip Touch LSIG	1SDA076923R1		1SDA077003R1	
				E1.2B-A 1200 Ekip Hi-Touch LSI	1SDA076925R1		1SDA077005R1	
				E1.2B-A 1200 Ekip Hi-Touch LSIG	1SDA076926R1		1SDA077006R1	
E1.2N-A	800	50	50	E1.2N-A 800 Ekip Dip LI	1SDA076928R1		1SDA077008R1	
				E1.2N-A 800 Ekip Dip LSI	1SDA076929R1		1SDA077009R1	
				E1.2N-A 800 Ekip Dip LSIG	1SDA076930R1		1SDA077010R1	
				E1.2N-A 800 Ekip Touch LI	1SDA076931R1		1SDA077011R1	
				E1.2N-A 800 Ekip Touch LSI	1SDA076932R1		1SDA077012R1	
				E1.2N-A 800 Ekip Touch LSIG	1SDA076933R1		1SDA077013R1	
				E1.2N-A 800 Ekip Hi-Touch LSI	1SDA076935R1		1SDA077015R1	
				E1.2N-A 800 Ekip Hi-Touch LSIG	1SDA076936R1		1SDA077016R1	
	1200	50	50	E1.2N-A 1200 Ekip Dip LI	1SDA076938R1		1SDA077018R1	
				E1.2N-A 1200 Ekip Dip LSI	1SDA076939R1		1SDA077019R1	
				E1.2N-A 1200 Ekip Dip LSIG	1SDA076940R1		1SDA077020R1	
				E1.2N-A 1200 Ekip Touch LI	1SDA076941R1		1SDA077021R1	
				E1.2N-A 1200 Ekip Touch LSI	1SDA076942R1		1SDA077022R1	
				E1.2N-A 1200 Ekip Touch LSIG	1SDA076943R1		1SDA077023R1	
				E1.2N-A 1200 Ekip Hi-Touch LSI	1SDA076945R1		1SDA077025R1	
				E1.2N-A 1200 Ekip Hi-Touch LSIG	1SDA076946R1		1SDA077026R1	

Automatic circuit breakers

Fixed version for power distribution



SACE Emax E1.2S-A • Front terminals (F)

Size	Frame Amps	Int. Rating (kA@508V)	Withstand (kA)	Type	3 Poles		4 Poles	
					Global code		Global code	
E1.2S-A	250	65	50	E1.2S-A 250 Ekip Dip LI	1SDA076948R1		1SDA077028R1	
				E1.2S-A 250 Ekip Dip LSI	1SDA076949R1		1SDA077029R1	
				E1.2S-A 250 Ekip Dip LSIG	1SDA076950R1		1SDA077030R1	
				E1.2S-A 250 Ekip Touch LI	1SDA076951R1		1SDA077031R1	
				E1.2S-A 250 Ekip Touch LSI	1SDA076952R1		1SDA077032R1	
				E1.2S-A 250 Ekip Touch LSIG	1SDA076953R1		1SDA077033R1	
				E1.2S-A 250 Ekip Hi-Touch LSI	1SDA076955R1		1SDA077035R1	
				E1.2S-A 250 Ekip Hi-Touch LSIG	1SDA076956R1		1SDA077036R1	
	400	65	50	E1.2S-A 400 Ekip Dip LI	1SDA076958R1		1SDA077038R1	
				E1.2S-A 400 Ekip Dip LSI	1SDA076959R1		1SDA077039R1	
				E1.2S-A 400 Ekip Dip LSIG	1SDA076960R1		1SDA077040R1	
				E1.2S-A 400 Ekip Touch LI	1SDA076961R1		1SDA077041R1	
				E1.2S-A 400 Ekip Touch LSI	1SDA076962R1		1SDA077042R1	
				E1.2S-A 400 Ekip Touch LSIG	1SDA076963R1		1SDA077043R1	
				E1.2S-A 400 Ekip Hi-Touch LSI	1SDA076965R1		1SDA077045R1	
				E1.2S-A 400 Ekip Hi-Touch LSIG	1SDA076966R1		1SDA077046R1	
	800	65	50	E1.2S-A 800 Ekip Dip LI	1SDA076968R1		1SDA077048R1	
				E1.2S-A 800 Ekip Dip LSI	1SDA076969R1		1SDA077049R1	
				E1.2S-A 800 Ekip Dip LSIG	1SDA076970R1		1SDA077050R1	
				E1.2S-A 800 Ekip Touch LI	1SDA076971R1		1SDA077051R1	
				E1.2S-A 800 Ekip Touch LSI	1SDA076972R1		1SDA077052R1	
				E1.2S-A 800 Ekip Touch LSIG	1SDA076973R1		1SDA077053R1	
				E1.2S-A 800 Ekip Hi-Touch LSI	1SDA076975R1		1SDA077055R1	
				E1.2S-A 800 Ekip Hi-Touch LSIG	1SDA076976R1		1SDA077056R1	
	1200	65	50	E1.2S-A 1200 Ekip Dip LI	1SDA076978R1		1SDA077058R1	
				E1.2S-A 1200 Ekip Dip LSI	1SDA076979R1		1SDA077059R1	
				E1.2S-A 1200 Ekip Dip LSIG	1SDA076980R1		1SDA077060R1	
				E1.2S-A 1200 Ekip Touch LI	1SDA076981R1		1SDA077061R1	
E1.2S-A 1200 Ekip Touch LSI				1SDA076982R1		1SDA077062R1		
E1.2S-A 1200 Ekip Touch LSIG				1SDA076983R1		1SDA077063R1		
E1.2S-A 1200 Ekip Hi-Touch LSI				1SDA076985R1		1SDA077065R1		
E1.2S-A 1200 Ekip Hi-Touch LSIG				1SDA076986R1		1SDA077066R1		



1SDC200039D0201_UL

SACE Emax 2 E2.2B-A/N-A • Orientable rear terminals (HR)

Size	Frame Amps	Int. Rating (kA@508V)	Withstand (kA)	Type	3 Poles		4 Poles		
					Global code		Global code		
E2.2B-A	1600	42	42	E2.2B-A 1600 Ekip Dip LI	1SDA077228R1		1SDA077398R1		
				E2.2B-A 1600 Ekip Dip LSI	1SDA077229R1		1SDA077399R1		
				E2.2B-A 1600 Ekip Dip LSIG	1SDA077230R1		1SDA077400R1		
				E2.2B-A 1600 Ekip Touch LI	1SDA077231R1		1SDA077401R1		
				E2.2B-A 1600 Ekip Touch LSI	1SDA077232R1		1SDA077402R1		
				E2.2B-A 1600 Ekip Touch LSIG	1SDA077233R1		1SDA077403R1		
				E2.2B-A 1600 Ekip Hi-Touch LSI	1SDA077235R1		1SDA077405R1		
				E2.2B-A 1600 Ekip Hi-Touch LSIG	1SDA077236R1		1SDA077406R1		
E2.2N-A	1600	50	50	E2.2N-A 1600 Ekip Dip LI	1SDA077278R1		1SDA077448R1		
				E2.2N-A 1600 Ekip Dip LSI	1SDA077279R1		1SDA077449R1		
				E2.2N-A 1600 Ekip Dip LSIG	1SDA077280R1		1SDA077450R1		
				E2.2N-A 1600 Ekip Touch LI	1SDA077281R1		1SDA077451R1		
				E2.2N-A 1600 Ekip Touch LSI	1SDA077282R1		1SDA077452R1		
				E2.2N-A 1600 Ekip Touch LSIG	1SDA077283R1		1SDA077453R1		
				E2.2N-A 1600 Ekip Hi-Touch LSI	1SDA077285R1		1SDA077455R1		
				E2.2N-A 1600 Ekip Hi-Touch LSIG	1SDA077286R1		1SDA077456R1		
	2000	50	50	50	E2.2N-A 2000 Ekip Dip LI	1SDA077288R1		1SDA077458R1	
					E2.2N-A 2000 Ekip Dip LSI	1SDA077289R1		1SDA077459R1	
					E2.2N-A 2000 Ekip Dip LSIG	1SDA077290R1		1SDA077460R1	
					E2.2N-A 2000 Ekip Touch LI	1SDA077291R1		1SDA077461R1	
					E2.2N-A 2000 Ekip Touch LSI	1SDA077292R1		1SDA077462R1	
					E2.2N-A 2000 Ekip Touch LSIG	1SDA077293R1		1SDA077463R1	
					E2.2N-A 2000 Ekip Hi-Touch LSI	1SDA077295R1		1SDA077465R1	
					E2.2N-A 2000 Ekip Hi-Touch LSIG	1SDA077296R1		1SDA077466R1	

Automatic circuit breakers

Fixed version for power distribution



SACE Emax 2 E2.2S-A • Orientable rear terminals (HR)

Size	Frame Amps	Int. Rating (kA@508V)	Withstand (kA)	Type	3 Poles		4 Poles	
					Global code		Global code	
E2.2S-A	800	65	65	E2.2S-A 800 Ekip Dip LI	1SDA077298R1		1SDA077468R1	
				E2.2S-A 800 Ekip Dip LSI	1SDA077299R1		1SDA077469R1	
				E2.2S-A 800 Ekip Dip LSIG	1SDA077300R1		1SDA077470R1	
				E2.2S-A 800 Ekip Touch LI	1SDA077301R1		1SDA077471R1	
				E2.2S-A 800 Ekip Touch LSI	1SDA077302R1		1SDA077472R1	
				E2.2S-A 800 Ekip Touch LSIG	1SDA077303R1		1SDA077473R1	
				E2.2S-A 800 Ekip Hi-Touch LSI	1SDA077305R1		1SDA077475R1	
				E2.2S-A 800 Ekip Hi-Touch LSIG	1SDA077306R1		1SDA077476R1	
	1200	65	65	E2.2S-A 1200 Ekip Dip LI	1SDA077308R1		1SDA077478R1	
				E2.2S-A 1200 Ekip Dip LSI	1SDA077309R1		1SDA077479R1	
				E2.2S-A 1200 Ekip Dip LSIG	1SDA077310R1		1SDA077480R1	
				E2.2S-A 1200 Ekip Touch LI	1SDA077311R1		1SDA077481R1	
				E2.2S-A 1200 Ekip Touch LSI	1SDA077312R1		1SDA077482R1	
				E2.2S-A 1200 Ekip Touch LSIG	1SDA077313R1		1SDA077483R1	
				E2.2S-A 1200 Ekip Hi-Touch LSI	1SDA077315R1		1SDA077485R1	
				E2.2S-A 1200 Ekip Hi-Touch LSIG	1SDA077316R1		1SDA077486R1	
	1600	65	65	E2.2S-A 1600 Ekip Dip LI	1SDA077318R1		1SDA077488R1	
				E2.2S-A 1600 Ekip Dip LSI	1SDA077319R1		1SDA077489R1	
				E2.2S-A 1600 Ekip Dip LSIG	1SDA077320R1		1SDA077490R1	
				E2.2S-A 1600 Ekip Touch LI	1SDA077321R1		1SDA077491R1	
				E2.2S-A 1600 Ekip Touch LSI	1SDA077322R1		1SDA077492R1	
				E2.2S-A 1600 Ekip Touch LSIG	1SDA077323R1		1SDA077493R1	
				E2.2S-A 1600 Ekip Hi-Touch LSI	1SDA077325R1		1SDA077495R1	
				E2.2S-A 1600 Ekip Hi-Touch LSIG	1SDA077326R1		1SDA077496R1	
	2000	65	65	E2.2S-A 2000 Ekip Dip LI	1SDA077328R1		1SDA077498R1	
				E2.2S-A 2000 Ekip Dip LSI	1SDA077329R1		1SDA077499R1	
				E2.2S-A 2000 Ekip Dip LSIG	1SDA077330R1		1SDA077500R1	
				E2.2S-A 2000 Ekip Touch LI	1SDA077331R1		1SDA077501R1	
E2.2S-A 2000 Ekip Touch LSI				1SDA077332R1		1SDA077502R1		
E2.2S-A 2000 Ekip Touch LSIG				1SDA077333R1		1SDA077503R1		
E2.2S-A 2000 Ekip Hi-Touch LSI				1SDA077335R1		1SDA077505R1		
E2.2S-A 2000 Ekip Hi-Touch LSIG				1SDA077336R1		1SDA077506R1		



1SDC200039D0201_UL

SACE Emax 2 E2.2H-A • Orientable rear terminals (HR)

Size	Frame Amps	Int. Rating (kA@508V)	Withstand (kA)	Type	3 Poles		4 Poles	
					Global code		Global code	
E2.2H-A	800	85	85	E2.2H-A 800 Ekip Dip LI	1SDA077238R1		1SDA077408R1	
				E2.2H-A 800 Ekip Dip LSI	1SDA077239R1		1SDA077409R1	
				E2.2H-A 800 Ekip Dip LSIG	1SDA077240R1		1SDA077410R1	
				E2.2H-A 800 Ekip Touch LI	1SDA077241R1		1SDA077411R1	
				E2.2H-A 800 Ekip Touch LSI	1SDA077242R1		1SDA077412R1	
				E2.2H-A 800 Ekip Touch LSIG	1SDA077243R1		1SDA077413R1	
				E2.2H-A 800 Ekip Hi-Touch LSI	1SDA077245R1		1SDA077415R1	
				E2.2H-A 800 Ekip Hi-Touch LSIG	1SDA077246R1		1SDA077416R1	
	1200	85	85	E2.2H-A 1200 Ekip Dip LI	1SDA077248R1		1SDA077418R1	
				E2.2H-A 1200 Ekip Dip LSI	1SDA077249R1		1SDA077419R1	
				E2.2H-A 1200 Ekip Dip LSIG	1SDA077250R1		1SDA077420R1	
				E2.2H-A 1200 Ekip Touch LI	1SDA077251R1		1SDA077421R1	
				E2.2H-A 1200 Ekip Touch LSI	1SDA077252R1		1SDA077422R1	
				E2.2H-A 1200 Ekip Touch LSIG	1SDA077253R1		1SDA077423R1	
				E2.2H-A 1200 Ekip Hi-Touch LSI	1SDA077255R1		1SDA077425R1	
				E2.2H-A 1200 Ekip Hi-Touch LSIG	1SDA077256R1		1SDA077426R1	
	1600	85	85	E2.2H-A 1600 Ekip Dip LI	1SDA077258R1		1SDA077428R1	
				E2.2H-A 1600 Ekip Dip LSI	1SDA077259R1		1SDA077429R1	
				E2.2H-A 1600 Ekip Dip LSIG	1SDA077260R1		1SDA077430R1	
				E2.2H-A 1600 Ekip Touch LI	1SDA077261R1		1SDA077431R1	
				E2.2H-A 1600 Ekip Touch LSI	1SDA077262R1		1SDA077432R1	
				E2.2H-A 1600 Ekip Touch LSIG	1SDA077263R1		1SDA077433R1	
				E2.2H-A 1600 Ekip Hi-Touch LSI	1SDA077265R1		1SDA077435R1	
				E2.2H-A 1600 Ekip Hi-Touch LSIG	1SDA077266R1		1SDA077436R1	
	2000	85	85	E2.2H-A 2000 Ekip Dip LI	1SDA077268R1		1SDA077438R1	
				E2.2H-A 2000 Ekip Dip LSI	1SDA077269R1		1SDA077439R1	
				E2.2H-A 2000 Ekip Dip LSIG	1SDA077270R1		1SDA077440R1	
				E2.2H-A 2000 Ekip Touch LI	1SDA077271R1		1SDA077441R1	
E2.2H-A 2000 Ekip Touch LSI				1SDA077272R1		1SDA077442R1		
E2.2H-A 2000 Ekip Touch LSIG				1SDA077273R1		1SDA077443R1		
E2.2H-A 2000 Ekip Hi-Touch LSI				1SDA077275R1		1SDA077445R1		
E2.2H-A 2000 Ekip Hi-Touch LSIG				1SDA077276R1		1SDA077446R1		

Automatic circuit breakers

Fixed version for power distribution



1SDC20002P001_LUL

SACE Emax 2 E2.2V-A • Orientable rear terminals (HR)

Size	Frame Amps	Int. Rating (kA@508V)	Withstand (kA)	Type	3 Poles		4 Poles		
					Global code		Global code		
E2.2V-A	250	100	85	E2.2V-A 250 Ekip Dip LI	1SDA077338R1		1SDA077508R1		
				E2.2V-A 250 Ekip Dip LSI	1SDA077339R1		1SDA077509R1		
				E2.2V-A 250 Ekip Dip LSIG	1SDA077340R1		1SDA077510R1		
				E2.2V-A 250 Ekip Touch LI	1SDA077341R1		1SDA077511R1		
				E2.2V-A 250 Ekip Touch LSI	1SDA077342R1		1SDA077512R1		
				E2.2V-A 250 Ekip Touch LSIG	1SDA077343R1		1SDA077513R1		
	400	100	85	E2.2V-A 250 Ekip Hi-Touch LSI	1SDA077345R1		1SDA077515R1		
				E2.2V-A 250 Ekip Hi-Touch LSIG	1SDA077346R1		1SDA077516R1		
				E2.2V-A 400 Ekip Dip LI	1SDA077348R1		1SDA077518R1		
				E2.2V-A 400 Ekip Dip LSI	1SDA077349R1		1SDA077519R1		
				E2.2V-A 400 Ekip Dip LSIG	1SDA077350R1		1SDA077520R1		
				E2.2V-A 400 Ekip Touch LI	1SDA077351R1		1SDA077521R1		
		800	100	85	E2.2V-A 400 Ekip Touch LSI	1SDA077352R1		1SDA077522R1	
					E2.2V-A 400 Ekip Touch LSIG	1SDA077353R1		1SDA077523R1	
					E2.2V-A 400 Ekip Hi-Touch LSI	1SDA077355R1		1SDA077525R1	
					E2.2V-A 400 Ekip Hi-Touch LSIG	1SDA077356R1		1SDA077526R1	
					E2.2V-A 800 Ekip Dip LI	1SDA077358R1		1SDA077528R1	
					E2.2V-A 800 Ekip Dip LSI	1SDA077359R1		1SDA077529R1	
	1200	100	85	E2.2V-A 800 Ekip Dip LSIG	1SDA077360R1		1SDA077530R1		
				E2.2V-A 800 Ekip Touch LI	1SDA077361R1		1SDA077531R1		
				E2.2V-A 800 Ekip Touch LSI	1SDA077362R1		1SDA077532R1		
				E2.2V-A 800 Ekip Touch LSIG	1SDA077363R1		1SDA077533R1		
				E2.2V-A 800 Ekip Hi-Touch LSI	1SDA077365R1		1SDA077535R1		
				E2.2V-A 800 Ekip Hi-Touch LSIG	1SDA077366R1		1SDA077536R1		
1600		100	85	E2.2V-A 1200 Ekip Dip LI	1SDA077368R1		1SDA077538R1		
				E2.2V-A 1200 Ekip Dip LSI	1SDA077369R1		1SDA077539R1		
				E2.2V-A 1200 Ekip Dip LSIG	1SDA077370R1		1SDA077540R1		
				E2.2V-A 1200 Ekip Touch LI	1SDA077371R1		1SDA077541R1		
				E2.2V-A 1200 Ekip Touch LSI	1SDA077372R1		1SDA077542R1		
				E2.2V-A 1200 Ekip Touch LSIG	1SDA077373R1		1SDA077543R1		
2000	100	85	E2.2V-A 1200 Ekip Hi-Touch LSI	1SDA077375R1		1SDA077545R1			
			E2.2V-A 1200 Ekip Hi-Touch LSIG	1SDA077376R1		1SDA077546R1			
			E2.2V-A 1600 Ekip Dip LI	1SDA077378R1		1SDA077548R1			
			E2.2V-A 1600 Ekip Dip LSI	1SDA077379R1		1SDA077549R1			
			E2.2V-A 1600 Ekip Dip LSIG	1SDA077380R1		1SDA077550R1			
			E2.2V-A 1600 Ekip Touch LI	1SDA077381R1		1SDA077551R1			
			E2.2V-A 1600 Ekip Touch LSI	1SDA077382R1		1SDA077552R1			
			E2.2V-A 1600 Ekip Touch LSIG	1SDA077383R1		1SDA077553R1			
			E2.2V-A 1600 Ekip Hi-Touch LSI	1SDA077385R1		1SDA077555R1			
			E2.2V-A 1600 Ekip Hi-Touch LSIG	1SDA077386R1		1SDA077556R1			
			E2.2V-A 2000 Ekip Dip LI	1SDA077388R1		1SDA077558R1			
			E2.2V-A 2000 Ekip Dip LSI	1SDA077389R1		1SDA077559R1			
			E2.2V-A 2000 Ekip Dip LSIG	1SDA077390R1		1SDA077560R1			
			E2.2V-A 2000 Ekip Touch LI	1SDA077391R1		1SDA077561R1			
			E2.2V-A 2000 Ekip Touch LSI	1SDA077392R1		1SDA077562R1			
			E2.2V-A 2000 Ekip Touch LSIG	1SDA077393R1		1SDA077563R1			
			E2.2V-A 2000 Ekip Hi-Touch LSI	1SDA077395R1		1SDA077565R1			
			E2.2V-A 2000 Ekip Hi-Touch LSIG	1SDA077396R1		1SDA077566R1			



1SDC200039D0201_LUL

SACE Emax 2 E4.2S-A/H-A • Orientable rear terminals up to 2500 A (HR)

Size	Frame Amps	Int. Rating (kA@508V)	Withstand (kA)	Type	3 Poles		4 Poles	
					Global code		Global code	
E4.2S-A	2500	65	65	E4.2S-A 2500 Ekip Dip LI	1SDA077998R1		1SDA078228R1	
				E4.2S-A 2500 Ekip Dip LSI	1SDA077999R1		1SDA078229R1	
				E4.2S-A 2500 Ekip Dip LSIG	1SDA078000R1		1SDA078230R1	
				E4.2S-A 2500 Ekip Touch LI	1SDA078001R1		1SDA078231R1	
				E4.2S-A 2500 Ekip Touch LSI	1SDA078002R1		1SDA078232R1	
				E4.2S-A 2500 Ekip Touch LSIG	1SDA078003R1		1SDA078233R1	
				E4.2S-A 2500 Ekip Hi-Touch LSI	1SDA078005R1		1SDA078235R1	
				E4.2S-A 2500 Ekip Hi-Touch LSIG	1SDA078006R1		1SDA078236R1	
	3200 (*)	65	65	E4.2S-A 3200 Ekip Dip LI	1SDA078008R1		1SDA078238R1	
				E4.2S-A 3200 Ekip Dip LSI	1SDA078009R1		1SDA078239R1	
				E4.2S-A 3200 Ekip Dip LSIG	1SDA078010R1		1SDA078240R1	
				E4.2S-A 3200 Ekip Touch LI	1SDA078011R1		1SDA078241R1	
				E4.2S-A 3200 Ekip Touch LSI	1SDA078012R1		1SDA078242R1	
				E4.2S-A 3200 Ekip Touch LSIG	1SDA078013R1		1SDA078243R1	
				E4.2S-A 3200 Ekip Hi-Touch LSI	1SDA078015R1		1SDA078245R1	
				E4.2S-A 3200 Ekip Hi-Touch LSIG	1SDA078016R1		1SDA078246R1	
E4.2H-A	2500	85	85	E4.2H-A 2500 Ekip Dip LI	1SDA077908R1		1SDA078138R1	
				E4.2H-A 2500 Ekip Dip LSI	1SDA077909R1		1SDA078139R1	
				E4.2H-A 2500 Ekip Dip LSIG	1SDA077910R1		1SDA078140R1	
				E4.2H-A 2500 Ekip Touch LI	1SDA077911R1		1SDA078141R1	
				E4.2H-A 2500 Ekip Touch LSI	1SDA077912R1		1SDA078142R1	
				E4.2H-A 2500 Ekip Touch LSIG	1SDA077913R1		1SDA078143R1	
				E4.2H-A 2500 Ekip Hi-Touch LSI	1SDA077915R1		1SDA078145R1	
				E4.2H-A 2500 Ekip Hi-Touch LSIG	1SDA077916R1		1SDA078146R1	
	3200 (*)	85	85	E4.2H-A 3200 Ekip Dip LI	1SDA077918R1		1SDA078148R1	
				E4.2H-A 3200 Ekip Dip LSI	1SDA077919R1		1SDA078149R1	
				E4.2H-A 3200 Ekip Dip LSIG	1SDA077920R1		1SDA078150R1	
				E4.2H-A 3200 Ekip Touch LI	1SDA077921R1		1SDA078151R1	
				E4.2H-A 3200 Ekip Touch LSI	1SDA077922R1		1SDA078152R1	
				E4.2H-A 3200 Ekip Touch LSIG	1SDA077923R1		1SDA078153R1	
				E4.2H-A 3200 Ekip Hi-Touch LSI	1SDA077925R1		1SDA078155R1	
				E4.2H-A 3200 Ekip Hi-Touch LSIG	1SDA077926R1		1SDA078156R1	

* 3200A ratings only with rear vertical terminals

Automatic circuit breakers

Fixed version for power distribution



SACE Emax 2 E4.2V-A • Orientable rear terminals up to 2500 A (HR)

Size	Frame Amps	Int. Rating (kA@508V)	Withstand (kA)	Type	3 Poles		4 Poles	
					Global code		Global code	
E4.2V-A	800	100	85	E4.2V-A 800 Ekip Dip LI	1SDA078028R1		1SDA078258R1	
				E4.2V-A 800 Ekip Dip LSI	1SDA078029R1		1SDA078259R1	
				E4.2V-A 800 Ekip Dip LSIG	1SDA078030R1		1SDA078260R1	
				E4.2V-A 800 Ekip Touch LI	1SDA078031R1		1SDA078261R1	
				E4.2V-A 800 Ekip Touch LSI	1SDA078032R1		1SDA078262R1	
				E4.2V-A 800 Ekip Touch LSIG	1SDA078033R1		1SDA078263R1	
				E4.2V-A 800 Ekip Hi-Touch LSI	1SDA078035R1		1SDA078265R1	
				E4.2V-A 800 Ekip Hi-Touch LSIG	1SDA078036R1		1SDA078266R1	
	1600	100	85	E4.2V-A 1600 Ekip Dip LI	1SDA078038R1		1SDA078268R1	
				E4.2V-A 1600 Ekip Dip LSI	1SDA078039R1		1SDA078269R1	
				E4.2V-A 1600 Ekip Dip LSIG	1SDA078040R1		1SDA078270R1	
				E4.2V-A 1600 Ekip Touch LI	1SDA078041R1		1SDA078271R1	
				E4.2V-A 1600 Ekip Touch LSI	1SDA078042R1		1SDA078272R1	
				E4.2V-A 1600 Ekip Touch LSIG	1SDA078043R1		1SDA078273R1	
				E4.2V-A 1600 Ekip Hi-Touch LSI	1SDA078045R1		1SDA078275R1	
				E4.2V-A 1600 Ekip Hi-Touch LSIG	1SDA078046R1		1SDA078276R1	
	2000	100	85	E4.2V-A 2000 Ekip Dip LI	1SDA078048R1		1SDA078278R1	
				E4.2V-A 2000 Ekip Dip LSI	1SDA078049R1		1SDA078279R1	
				E4.2V-A 2000 Ekip Dip LSIG	1SDA078050R1		1SDA078280R1	
				E4.2V-A 2000 Ekip Touch LI	1SDA078051R1		1SDA078281R1	
				E4.2V-A 2000 Ekip Touch LSI	1SDA078052R1		1SDA078282R1	
				E4.2V-A 2000 Ekip Touch LSIG	1SDA078053R1		1SDA078283R1	
				E4.2V-A 2000 Ekip Hi-Touch LSI	1SDA078055R1		1SDA078285R1	
				E4.2V-A 2000 Ekip Hi-Touch LSIG	1SDA078056R1		1SDA078286R1	
	2500	100	85	E4.2V-A 2500 Ekip Dip LI	1SDA078058R1		1SDA078288R1	
				E4.2V-A 2500 Ekip Dip LSI	1SDA078059R1		1SDA078289R1	
				E4.2V-A 2500 Ekip Dip LSIG	1SDA078060R1		1SDA078290R1	
				E4.2V-A 2500 Ekip Touch LI	1SDA078061R1		1SDA078291R1	
E4.2V-A 2500 Ekip Touch LSI				1SDA078062R1		1SDA078292R1		
E4.2V-A 2500 Ekip Touch LSIG				1SDA078063R1		1SDA078293R1		
E4.2V-A 2500 Ekip Hi-Touch LSI				1SDA078065R1		1SDA078295R1		
E4.2V-A 2500 Ekip Hi-Touch LSIG				1SDA078066R1		1SDA078296R1		
3200 (*)	100	85	E4.2V-A 3200 Ekip Dip LI	1SDA078068R1		1SDA078298R1		
			E4.2V-A 3200 Ekip Dip LSI	1SDA078069R1		1SDA078299R1		
			E4.2V-A 3200 Ekip Dip LSIG	1SDA078070R1		1SDA078300R1		
			E4.2V-A 3200 Ekip Touch LI	1SDA078071R1		1SDA078301R1		
			E4.2V-A 3200 Ekip Touch LSI	1SDA078072R1		1SDA078302R1		
			E4.2V-A 3200 Ekip Touch LSIG	1SDA078073R1		1SDA078303R1		
			E4.2V-A 3200 Ekip Hi-Touch LSI	1SDA078075R1		1SDA078305R1		
			E4.2V-A 3200 Ekip Hi-Touch LSIG	1SDA078076R1		1SDA078306R1		

* 3200A ratings only with rear vertical terminals



1SDC200039D0201_LUL

SACE Emax 2 E4.2L-A • Orientable rear terminals up to 2500 A (HR)

Size	Frame Amps	Int. Rating (kA@508V)	Withstand (kA)	Type	3 Poles		4 Poles	
					Global code		Global code	
E4.2L-A	800	125	100	E4.2L-A 800 Ekip Dip LI	1SDA077938R1		1SDA078168R1	
				E4.2L-A 800 Ekip Dip LSI	1SDA077939R1		1SDA078169R1	
				E4.2L-A 800 Ekip Dip LSIG	1SDA077940R1		1SDA078170R1	
				E4.2L-A 800 Ekip Touch LI	1SDA077941R1		1SDA078171R1	
				E4.2L-A 800 Ekip Touch LSI	1SDA077942R1		1SDA078172R1	
				E4.2L-A 800 Ekip Touch LSIG	1SDA077943R1		1SDA078173R1	
				E4.2L-A 800 Ekip Hi-Touch LSI	1SDA077945R1		1SDA078175R1	
				E4.2L-A 800 Ekip Hi-Touch LSIG	1SDA077946R1		1SDA078176R1	
	1600	125	100	E4.2L-A 1600 Ekip Dip LI	1SDA077948R1		1SDA078178R1	
				E4.2L-A 1600 Ekip Dip LSI	1SDA077949R1		1SDA078179R1	
				E4.2L-A 1600 Ekip Dip LSIG	1SDA077950R1		1SDA078180R1	
				E4.2L-A 1600 Ekip Touch LI	1SDA077951R1		1SDA078181R1	
				E4.2L-A 1600 Ekip Touch LSI	1SDA077952R1		1SDA078182R1	
				E4.2L-A 1600 Ekip Touch LSIG	1SDA077953R1		1SDA078183R1	
				E4.2L-A 1600 Ekip Hi-Touch LSI	1SDA077955R1		1SDA078185R1	
				E4.2L-A 1600 Ekip Hi-Touch LSIG	1SDA077956R1		1SDA078186R1	
	2000	125	100	E4.2L-A 2000 Ekip Dip LI	1SDA077958R1		1SDA078188R1	
				E4.2L-A 2000 Ekip Dip LSI	1SDA077959R1		1SDA078189R1	
				E4.2L-A 2000 Ekip Dip LSIG	1SDA077960R1		1SDA078190R1	
				E4.2L-A 2000 Ekip Touch LI	1SDA077961R1		1SDA078191R1	
				E4.2L-A 2000 Ekip Touch LSI	1SDA077962R1		1SDA078192R1	
				E4.2L-A 2000 Ekip Touch LSIG	1SDA077963R1		1SDA078193R1	
				E4.2L-A 2000 Ekip Hi-Touch LSI	1SDA077965R1		1SDA078195R1	
				E4.2L-A 2000 Ekip Hi-Touch LSIG	1SDA077966R1		1SDA078196R1	
	2500	125	100	E4.2L-A 2500 Ekip Dip LI	1SDA077968R1		1SDA078198R1	
				E4.2L-A 2500 Ekip Dip LSI	1SDA077969R1		1SDA078199R1	
				E4.2L-A 2500 Ekip Dip LSIG	1SDA077970R1		1SDA078200R1	
				E4.2L-A 2500 Ekip Touch LI	1SDA077971R1		1SDA078201R1	
E4.2L-A 2500 Ekip Touch LSI				1SDA077972R1		1SDA078202R1		
E4.2L-A 2500 Ekip Touch LSIG				1SDA077973R1		1SDA078203R1		
E4.2L-A 2500 Ekip Hi-Touch LSI				1SDA077975R1		1SDA078205R1		
E4.2L-A 2500 Ekip Hi-Touch LSIG				1SDA077976R1		1SDA078206R1		
3200 (*)	125	100	E4.2L-A 3200 Ekip Dip LI	1SDA077978R1		1SDA078208R1		
			E4.2L-A 3200 Ekip Dip LSI	1SDA077979R1		1SDA078209R1		
			E4.2L-A 3200 Ekip Dip LSIG	1SDA077980R1		1SDA078210R1		
			E4.2L-A 3200 Ekip Touch LI	1SDA077981R1		1SDA078211R1		
			E4.2L-A 3200 Ekip Touch LSI	1SDA077982R1		1SDA078212R1		
			E4.2L-A 3200 Ekip Touch LSIG	1SDA077983R1		1SDA078213R1		
			E4.2L-A 3200 Ekip Hi-Touch LSI	1SDA077985R1		1SDA078215R1		
			E4.2L-A 3200 Ekip Hi-Touch LSIG	1SDA077986R1		1SDA078216R1		

* 3200A ratings only with rear vertical terminals

Automatic circuit breakers

Fixed version for power distribution



SACE Emax 2 E4.2X-A • Orientable rear terminals up to 2500 A (HR)

Size	Frame Amps	Int. Rating (kA@508V)	Withstand (kA)	Type	3 Poles		4 Poles	
					Global code		Global code	
E4.2X-A(**)	1600	200	50	E4.2X-A 1600 Ekip Dip LI	1SDA078088R1		1SDA078318R1	
				E4.2X-A 1600 Ekip Dip LSI	1SDA078089R1		1SDA078319R1	
				E4.2X-A 1600 Ekip Dip LSIG	1SDA078090R1		1SDA078320R1	
				E4.2X-A 1600 Ekip Touch LI	1SDA078091R1		1SDA078321R1	
				E4.2X-A 1600 Ekip Touch LSI	1SDA078092R1		1SDA078322R1	
				E4.2X-A 1600 Ekip Touch LSIG	1SDA078093R1		1SDA078323R1	
				E4.2X-A 1600 Ekip Hi-Touch LSI	1SDA078095R1		1SDA078325R1	
				E4.2X-A 1600 Ekip Hi-Touch LSIG	1SDA078096R1		1SDA078326R1	
	2000	200	50	E4.2X-A 2000 Ekip Dip LI	1SDA078098R1		1SDA078328R1	
				E4.2X-A 2000 Ekip Dip LSI	1SDA078099R1		1SDA078329R1	
				E4.2X-A 2000 Ekip Dip LSIG	1SDA078100R1		1SDA078330R1	
				E4.2X-A 2000 Ekip Touch LI	1SDA078101R1		1SDA078331R1	
				E4.2X-A 2000 Ekip Touch LSI	1SDA078102R1		1SDA078332R1	
				E4.2X-A 2000 Ekip Touch LSIG	1SDA078103R1		1SDA078333R1	
				E4.2X-A 2000 Ekip Hi-Touch LSI	1SDA078105R1		1SDA078335R1	
				E4.2X-A 2000 Ekip Hi-Touch LSIG	1SDA078106R1		1SDA078336R1	
	2500	200	50	E4.2X-A 2500 Ekip Dip LI	1SDA078108R1		1SDA078338R1	
				E4.2X-A 2500 Ekip Dip LSI	1SDA078109R1		1SDA078339R1	
				E4.2X-A 2500 Ekip Dip LSIG	1SDA078110R1		1SDA078340R1	
				E4.2X-A 2500 Ekip Touch LI	1SDA078111R1		1SDA078341R1	
				E4.2X-A 2500 Ekip Touch LSI	1SDA078112R1		1SDA078342R1	
				E4.2X-A 2500 Ekip Touch LSIG	1SDA078113R1		1SDA078343R1	
				E4.2X-A 2500 Ekip Hi-Touch LSI	1SDA078115R1		1SDA078345R1	
				E4.2X-A 2500 Ekip Hi-Touch LSIG	1SDA078116R1		1SDA078346R1	
	3200 (*)	200	50	E4.2X-A 3200 Ekip Dip LI	1SDA078118R1		1SDA078348R1	
				E4.2X-A 3200 Ekip Dip LSI	1SDA078119R1		1SDA078349R1	
				E4.2X-A 3200 Ekip Dip LSIG	1SDA078120R1		1SDA078350R1	
				E4.2X-A 3200 Ekip Touch LI	1SDA078121R1		1SDA078351R1	
E4.2X-A 3200 Ekip Touch LSI				1SDA078122R1		1SDA078352R1		
E4.2X-A 3200 Ekip Touch LSIG				1SDA078123R1		1SDA078353R1		
E4.2X-A 3200 Ekip Hi-Touch LSI				1SDA078125R1		1SDA078355R1		
E4.2X-A 3200 Ekip Hi-Touch LSIG				1SDA078126R1		1SDA078356R1		

* 3200A ratings only with rear vertical terminals
 ** Version not yet available. Contact ABB



1SDC200664F001_LUL

SACE Emax 2 E6.2H-A/V-A • Orientable rear terminals up to 5000A (HR)

Size	Frame Amps	Int. Rating (kA@508V)	Withstand (kA)	Type	3 Poles		4 Poles	
					Global code		Global code	
E6.2H-A	4000	85	85	E6.2H-A 4000 Ekip Dip LI	1SDA078828R1		1SDA078948R1	
				E6.2H-A 4000 Ekip Dip LSI	1SDA078829R1		1SDA078949R1	
				E6.2H-A 4000 Ekip Dip LSIG	1SDA078830R1		1SDA078950R1	
				E6.2H-A 4000 Ekip Touch LI	1SDA078831R1		1SDA078951R1	
				E6.2H-A 4000 Ekip Touch LSI	1SDA078832R1		1SDA078952R1	
				E6.2H-A 4000 Ekip Touch LSIG	1SDA078833R1		1SDA078953R1	
				E6.2H-A 4000 Ekip Hi-Touch LSI	1SDA078835R1		1SDA078955R1	
				E6.2H-A 4000 Ekip Hi-Touch LSIG	1SDA078836R1		1SDA078956R1	
	5000	85	85	E6.2H-A 5000 Ekip Dip LI	1SDA078838R1		1SDA078958R1	
				E6.2H-A 5000 Ekip Dip LSI	1SDA078839R1		1SDA078959R1	
				E6.2H-A 5000 Ekip Dip LSIG	1SDA078840R1		1SDA078960R1	
				E6.2H-A 5000 Ekip Touch LI	1SDA078841R1		1SDA078961R1	
				E6.2H-A 5000 Ekip Touch LSI	1SDA078842R1		1SDA078962R1	
				E6.2H-A 5000 Ekip Touch LSIG	1SDA078843R1		1SDA078963R1	
				E6.2H-A 5000 Ekip Hi-Touch LSI	1SDA078845R1		1SDA078965R1	
				E6.2H-A 5000 Ekip Hi-Touch LSIG	1SDA078846R1		1SDA078966R1	
	6000 (*)	85	85	E6.2H-A 6000 Ekip Dip LI	1SDA078848R1		1SDA078968R1	
				E6.2H-A 6000 Ekip Dip LSI	1SDA078849R1		1SDA078969R1	
				E6.2H-A 6000 Ekip Dip LSIG	1SDA078850R1		1SDA078970R1	
				E6.2H-A 6000 Ekip Touch LI	1SDA078851R1		1SDA078971R1	
				E6.2H-A 6000 Ekip Touch LSI	1SDA078852R1		1SDA078972R1	
				E6.2H-A 6000 Ekip Touch LSIG	1SDA078853R1		1SDA078973R1	
				E6.2H-A 6000 Ekip Hi-Touch LSI	1SDA078855R1		1SDA078975R1	
				E6.2H-A 6000 Ekip Hi-Touch LSIG	1SDA078856R1		1SDA078976R1	
E6.2V-A	4000	100	100	E6.2V-A 4000 Ekip Dip LI	1SDA078888R1		1SDA079008R1	
				E6.2V-A 4000 Ekip Dip LSI	1SDA078889R1		1SDA079009R1	
				E6.2V-A 4000 Ekip Dip LSIG	1SDA078890R1		1SDA079010R1	
				E6.2V-A 4000 Ekip Touch LI	1SDA078891R1		1SDA079011R1	
				E6.2V-A 4000 Ekip Touch LSI	1SDA078892R1		1SDA079012R1	
				E6.2V-A 4000 Ekip Touch LSIG	1SDA078893R1		1SDA079013R1	
				E6.2V-A 4000 Ekip Hi-Touch LSI	1SDA078895R1		1SDA079015R1	
				E6.2V-A 4000 Ekip Hi-Touch LSIG	1SDA078896R1		1SDA079016R1	
	5000	100	100	E6.2V-A 5000 Ekip Dip LI	1SDA078898R1		1SDA079018R1	
				E6.2V-A 5000 Ekip Dip LSI	1SDA078899R1		1SDA079019R1	
				E6.2V-A 5000 Ekip Dip LSIG	1SDA078900R1		1SDA079020R1	
				E6.2V-A 5000 Ekip Touch LI	1SDA078901R1		1SDA079021R1	
				E6.2V-A 5000 Ekip Touch LSI	1SDA078902R1		1SDA079022R1	
				E6.2V-A 5000 Ekip Touch LSIG	1SDA078903R1		1SDA079023R1	
				E6.2V-A 5000 Ekip Hi-Touch LSI	1SDA078905R1		1SDA079025R1	
				E6.2V-A 5000 Ekip Hi-Touch LSIG	1SDA078906R1		1SDA079026R1	
	6000 (*)	100	100	E6.2V-A 6000 Ekip Dip LI	1SDA078908R1		1SDA079028R1	
				E6.2V-A 6000 Ekip Dip LSI	1SDA078909R1		1SDA079029R1	
				E6.2V-A 6000 Ekip Dip LSIG	1SDA078910R1		1SDA079030R1	
				E6.2V-A 6000 Ekip Touch LI	1SDA078911R1		1SDA079031R1	
				E6.2V-A 6000 Ekip Touch LSI	1SDA078912R1		1SDA079032R1	
				E6.2V-A 6000 Ekip Touch LSIG	1SDA078913R1		1SDA079033R1	
				E6.2V-A 6000 Ekip Hi-Touch LSI	1SDA078915R1		1SDA079035R1	
				E6.2V-A 6000 Ekip Hi-Touch LSIG	1SDA078916R1		1SDA079036R1	

* 6000A ratings only with rear vertical terminals. Version not yet available. Contact ABB

Automatic circuit breakers

Fixed version for power distribution



1SDC20064F001_UL

SACE Emax 2 E6.2L-AX • Orientable rear terminals up to 5000A (HR)

Size	Frame Amps	Int. Rating (kA@508V)	Withstand (kA)	Type	3 Poles		4 Poles	
					Global code		Global code	
E6.2L-A	4000	100	100	E6.2V-A 4000 Ekip Dip LI	1SDA078888R1		1SDA079008R1	
				E6.2V-A 4000 Ekip Dip LSI	1SDA078889R1		1SDA079009R1	
				E6.2V-A 4000 Ekip Dip LSIG	1SDA078890R1		1SDA079010R1	
				E6.2V-A 4000 Ekip Touch LI	1SDA078891R1		1SDA079011R1	
				E6.2V-A 4000 Ekip Touch LSI	1SDA078892R1		1SDA079012R1	
				E6.2V-A 4000 Ekip Touch LSIG	1SDA078893R1		1SDA079013R1	
				E6.2V-A 4000 Ekip Hi-Touch LSI	1SDA078895R1		1SDA079015R1	
				E6.2V-A 4000 Ekip Hi-Touch LSIG	1SDA078896R1		1SDA079016R1	
	5000	100	100	E6.2V-A 5000 Ekip Dip LI	1SDA078898R1		1SDA079018R1	
				E6.2V-A 5000 Ekip Dip LSI	1SDA078899R1		1SDA079019R1	
				E6.2V-A 5000 Ekip Dip LSIG	1SDA078900R1		1SDA079020R1	
				E6.2V-A 5000 Ekip Touch LI	1SDA078901R1		1SDA079021R1	
				E6.2V-A 5000 Ekip Touch LSI	1SDA078902R1		1SDA079022R1	
				E6.2V-A 5000 Ekip Touch LSIG	1SDA078903R1		1SDA079023R1	
				E6.2V-A 5000 Ekip Hi-Touch LSI	1SDA078905R1		1SDA079025R1	
				E6.2V-A 5000 Ekip Hi-Touch LSIG	1SDA078906R1		1SDA079026R1	
	6000 (*)	100	100	E6.2V-A 6000 Ekip Dip LI	1SDA078908R1		1SDA079028R1	
				E6.2V-A 6000 Ekip Dip LSI	1SDA078909R1		1SDA079029R1	
				E6.2V-A 6000 Ekip Dip LSIG	1SDA078910R1		1SDA079030R1	
				E6.2V-A 6000 Ekip Touch LI	1SDA078911R1		1SDA079031R1	
				E6.2V-A 6000 Ekip Touch LSI	1SDA078912R1		1SDA079032R1	
				E6.2V-A 6000 Ekip Touch LSIG	1SDA078913R1		1SDA079033R1	
				E6.2V-A 6000 Ekip Hi-Touch LSI	1SDA078915R1		1SDA079035R1	
				E6.2V-A 6000 Ekip Hi-Touch LSIG	1SDA078916R1		1SDA079036R1	
E6.2X-A (**)	4000	200	100	E6.2X-A 4000 Ekip Dip LI	1SDA078918R1		1SDA079038R1	
				E6.2X-A 4000 Ekip Dip LSI	1SDA078919R1		1SDA079039R1	
				E6.2X-A 4000 Ekip Dip LSIG	1SDA078920R1		1SDA079040R1	
				E6.2X-A 4000 Ekip Touch LI	1SDA078921R1		1SDA079041R1	
				E6.2X-A 4000 Ekip Touch LSI	1SDA078922R1		1SDA079042R1	
				E6.2X-A 4000 Ekip Touch LSIG	1SDA078923R1		1SDA079043R1	
				E6.2X-A 4000 Ekip Hi-Touch LSI	1SDA078925R1		1SDA079045R1	
				E6.2X-A 4000 Ekip Hi-Touch LSIG	1SDA078926R1		1SDA079046R1	
	5000	200	100	E6.2X-A 5000 Ekip Dip LI	1SDA078928R1		1SDA079048R1	
				E6.2X-A 5000 Ekip Dip LSI	1SDA078929R1		1SDA079049R1	
				E6.2X-A 5000 Ekip Dip LSIG	1SDA078930R1		1SDA079050R1	
				E6.2X-A 5000 Ekip Touch LI	1SDA078931R1		1SDA079051R1	
				E6.2X-A 5000 Ekip Touch LSI	1SDA078932R1		1SDA079052R1	
				E6.2X-A 5000 Ekip Touch LSIG	1SDA078933R1		1SDA079053R1	
				E6.2X-A 5000 Ekip Hi-Touch LSI	1SDA078935R1		1SDA079055R1	
				E6.2X-A 5000 Ekip Hi-Touch LSIG	1SDA078936R1		1SDA079056R1	
	6000 (*)	200	100	E6.2X-A 6000 Ekip Dip LI	1SDA078938R1		1SDA079058R1	
				E6.2X-A 6000 Ekip Dip LSI	1SDA078939R1		1SDA079059R1	
				E6.2X-A 6000 Ekip Dip LSIG	1SDA078940R1		1SDA079060R1	
				E6.2X-A 6000 Ekip Touch LI	1SDA078941R1		1SDA079061R1	
				E6.2X-A 6000 Ekip Touch LSI	1SDA078942R1		1SDA079062R1	
				E6.2X-A 6000 Ekip Touch LSIG	1SDA078943R1		1SDA079063R1	
				E6.2X-A 6000 Ekip Hi-Touch LSI	1SDA078945R1		1SDA079065R1	
				E6.2X-A 6000 Ekip Hi-Touch LSIG	1SDA078946R1		1SDA079066R1	

* 6000A ratings only with rear vertical terminals. Version not yet available. Contact ABB
 ** Version not yet available. Contact ABB



1SDC200664F001_LUL

SACE Emax 2 E6.2H-A/f/V-A/f full size • Orientable rear terminals up to 5000A (HR)

Size	Frame Amps	Int. Rating (kA@508V)	Withstand (kA)	Type	4 Poles		
					Global code		
E6.2H-A/f	4000	85	85	E6.2H-A/f 4000 Ekip Dip LI	1SDA079308R1		
				E6.2H-A/f 4000 Ekip Dip LSI	1SDA079309R1		
				E6.2H-A/f 4000 Ekip Dip LSIG	1SDA079310R1		
				E6.2H-A/f 4000 Ekip Touch LI	1SDA079311R1		
				E6.2H-A/f 4000 Ekip Touch LSI	1SDA079312R1		
				E6.2H-A/f 4000 Ekip Touch LSIG	1SDA079313R1		
				E6.2H-A/f 4000 Ekip Hi-Touch LSI	1SDA079315R1		
				E6.2H-A/f 4000 Ekip Hi-Touch LSIG	1SDA079316R1		
				5000	85	85	E6.2H-A/f 5000 Ekip Dip LI
	E6.2H-A/f 5000 Ekip Dip LSI	1SDA079319R1					
	E6.2H-A/f 5000 Ekip Dip LSIG	1SDA079320R1					
	E6.2H-A/f 5000 Ekip Touch LI	1SDA079321R1					
	E6.2H-A/f 5000 Ekip Touch LSI	1SDA079322R1					
	E6.2H-A/f 5000 Ekip Touch LSIG	1SDA079323R1					
	E6.2H-A/f 5000 Ekip Hi-Touch LSI	1SDA079325R1					
	E6.2H-A/f 5000 Ekip Hi-Touch LSIG	1SDA079326R1					
	6000 (*)	85	85				E6.2H-A/f 6000 Ekip Dip LI
				E6.2H-A/f 6000 Ekip Dip LSI	1SDA079329R1		
				E6.2H-A/f 6000 Ekip Dip LSIG	1SDA079330R1		
				E6.2H-A/f 6000 Ekip Touch LI	1SDA079331R1		
				E6.2H-A/f 6000 Ekip Touch LSI	1SDA079332R1		
				E6.2H-A/f 6000 Ekip Touch LSIG	1SDA079333R1		
				E6.2H-A/f 6000 Ekip Hi-Touch LSI	1SDA079335R1		
				E6.2H-A/f 6000 Ekip Hi-Touch LSIG	1SDA079336R1		
				E6.2V-A/f	4000	100	100
	E6.2V-A/f 4000 Ekip Dip LSI	1SDA079369R1					
	E6.2V-A/f 4000 Ekip Dip LSIG	1SDA079370R1					
E6.2V-A/f 4000 Ekip Touch LI	1SDA079371R1						
E6.2V-A/f 4000 Ekip Touch LSI	1SDA079372R1						
E6.2V-A/f 4000 Ekip Touch LSIG	1SDA079373R1						
E6.2V-A/f 4000 Ekip Hi-Touch LSI	1SDA079375R1						
E6.2V-A/f 4000 Ekip Hi-Touch LSIG	1SDA079376R1						
5000	100	100	E6.2V-A/f 5000 Ekip Dip LI				
			E6.2V-A/f 5000 Ekip Dip LSI		1SDA079379R1		
			E6.2V-A/f 5000 Ekip Dip LSIG		1SDA079380R1		
			E6.2V-A/f 5000 Ekip Touch LI		1SDA079381R1		
			E6.2V-A/f 5000 Ekip Touch LSI		1SDA079382R1		
			E6.2V-A/f 5000 Ekip Touch LSIG		1SDA079383R1		
			E6.2V-A/f 5000 Ekip Hi-Touch LSI		1SDA079385R1		
			E6.2V-A/f 5000 Ekip Hi-Touch LSIG		1SDA079386R1		
			6000 (*)		100	100	E6.2V-A/f 6000 Ekip Dip LI
E6.2V-A/f 6000 Ekip Dip LSI	1SDA079389R1						
E6.2V-A/f 6000 Ekip Dip LSIG	1SDA079390R1						
E6.2V-A/f 6000 Ekip Touch LI	1SDA079391R1						
E6.2V-A/f 6000 Ekip Touch LSI	1SDA079392R1						
E6.2V-A/f 6000 Ekip Touch LSIG	1SDA079393R1						
E6.2V-A/f 6000 Ekip Hi-Touch LSI	1SDA079395R1						
E6.2V-A/f 6000 Ekip Hi-Touch LSIG	1SDA079396R1						

* 6000A ratings only with rear vertical terminals. Version not yet available. Contact ABB

Automatic circuit breakers

Fixed version for power distribution



1SDC200664F001_UL

SACE Emax 2 E6.2L-A/f/X-A/f full size • Orientable rear terminals up to 5000A (HR)

Size	Frame Amps	Int. Rating (kA@508V)	Withstand (kA)	Type	4 Poles	
					Global code	
E6.2L-A/f	4000	150	100	E6.2L-A/f 4000 Ekip Dip LI	1SDA079338R1	
				E6.2L-A/f 4000 Ekip Dip LSI	1SDA079339R1	
				E6.2L-A/f 4000 Ekip Dip LSIG	1SDA079340R1	
				E6.2L-A/f 4000 Ekip Touch LI	1SDA079341R1	
				E6.2L-A/f 4000 Ekip Touch LSI	1SDA079342R1	
				E6.2L-A/f 4000 Ekip Touch LSIG	1SDA079343R1	
				E6.2L-A/f 4000 Ekip Hi-Touch LSI	1SDA079345R1	
				E6.2L-A/f 4000 Ekip Hi-Touch LSIG	1SDA079346R1	
	5000	150	100	E6.2L-A/f 5000 Ekip Dip LI	1SDA079348R1	
				E6.2L-A/f 5000 Ekip Dip LSI	1SDA079349R1	
				E6.2L-A/f 5000 Ekip Dip LSIG	1SDA079350R1	
				E6.2L-A/f 5000 Ekip Touch LI	1SDA079351R1	
				E6.2L-A/f 5000 Ekip Touch LSI	1SDA079352R1	
				E6.2L-A/f 5000 Ekip Touch LSIG	1SDA079353R1	
				E6.2L-A/f 5000 Ekip Hi-Touch LSI	1SDA079355R1	
				E6.2L-A/f 5000 Ekip Hi-Touch LSIG	1SDA079356R1	
	6000 (*)	150	100	E6.2L-A/f 6000 Ekip Dip LI	1SDA079358R1	
				E6.2L-A/f 6000 Ekip Dip LSI	1SDA079359R1	
				E6.2L-A/f 6000 Ekip Dip LSIG	1SDA079360R1	
				E6.2L-A/f 6000 Ekip Touch LI	1SDA079361R1	
				E6.2L-A/f 6000 Ekip Touch LSI	1SDA079362R1	
				E6.2L-A/f 6000 Ekip Touch LSIG	1SDA079363R1	
				E6.2L-A/f 6000 Ekip Hi-Touch LSI	1SDA079365R1	
				E6.2L-A/f 6000 Ekip Hi-Touch LSIG	1SDA079366R1	
E6.2X-A/f (**)	4000	200	100	E6.2X-A/f 4000 Ekip Dip LI	1SDA079398R1	
				E6.2X-A/f 4000 Ekip Dip LSI	1SDA079399R1	
				E6.2X-A/f 4000 Ekip Dip LSIG	1SDA079400R1	
				E6.2X-A/f 4000 Ekip Touch LI	1SDA079401R1	
				E6.2X-A/f 4000 Ekip Touch LSI	1SDA079402R1	
				E6.2X-A/f 4000 Ekip Touch LSIG	1SDA079403R1	
				E6.2X-A/f 4000 Ekip Hi-Touch LSI	1SDA079405R1	
				E6.2X-A/f 4000 Ekip Hi-Touch LSIG	1SDA079406R1	
	5000	200	100	E6.2X-A/f 5000 Ekip Dip LI	1SDA079408R1	
				E6.2X-A/f 5000 Ekip Dip LSI	1SDA079409R1	
				E6.2X-A/f 5000 Ekip Dip LSIG	1SDA079410R1	
				E6.2X-A/f 5000 Ekip Touch LI	1SDA079411R1	
				E6.2X-A/f 5000 Ekip Touch LSI	1SDA079412R1	
				E6.2X-A/f 5000 Ekip Touch LSIG	1SDA079413R1	
				E6.2X-A/f 5000 Ekip Hi-Touch LSI	1SDA079415R1	
				E6.2X-A/f 5000 Ekip Hi-Touch LSIG	1SDA079416R1	
	6000 (*)	200	100	E6.2X-A/f 6000 Ekip Dip LI	1SDA079418R1	
				E6.2X-A/f 6000 Ekip Dip LSI	1SDA079419R1	
				E6.2X-A/f 6000 Ekip Dip LSIG	1SDA079420R1	
				E6.2X-A/f 6000 Ekip Touch LI	1SDA079421R1	
				E6.2X-A/f 6000 Ekip Touch LSI	1SDA079422R1	
				E6.2X-A/f 6000 Ekip Touch LSIG	1SDA079423R1	
				E6.2X-A/f 6000 Ekip Hi-Touch LSI	1SDA079425R1	
				E6.2X-A/f 6000 Ekip Hi-Touch LSIG	1SDA079426R1	

* 6000A ratings only with rear vertical terminals. Version not yet available. Contact ABB

** Version not yet available. Contact ABB

Automatic circuit breakers

Drawout version for power distribution



SACE Emax 2 E1.2B-A/N-A • Mobile part of drawout circuit breaker (MP)

Size	Frame Amps	Int. Rating (kA@508V)	Withstand (kA)	Type	3 Poles		4 Poles	
					Global code		Global code	
E1.2B-A	800	42	42	E1.2B-A 800 Ekip Dip LI	1SDA077068R1		1SDA077148R1	
				E1.2B-A 800 Ekip Dip LSI	1SDA077069R1		1SDA077149R1	
				E1.2B-A 800 Ekip Dip LSIG	1SDA077070R1		1SDA077150R1	
				E1.2B-A 800 Ekip Touch LI	1SDA077071R1		1SDA077151R1	
				E1.2B-A 800 Ekip Touch LSI	1SDA077072R1		1SDA077152R1	
				E1.2B-A 800 Ekip Touch LSIG	1SDA077073R1		1SDA077153R1	
				E1.2B-A 800 Ekip Hi-Touch LSI	1SDA077075R1		1SDA077155R1	
				E1.2B-A 800 Ekip Hi-Touch LSIG	1SDA077076R1		1SDA077156R1	
	1200	42	42	E1.2B-A 1200 Ekip Dip LI	1SDA077078R1		1SDA077158R1	
				E1.2B-A 1200 Ekip Dip LSI	1SDA077079R1		1SDA077159R1	
				E1.2B-A 1200 Ekip Dip LSIG	1SDA077080R1		1SDA077160R1	
				E1.2B-A 1200 Ekip Touch LI	1SDA077081R1		1SDA077161R1	
				E1.2B-A 1200 Ekip Touch LSI	1SDA077082R1		1SDA077162R1	
				E1.2B-A 1200 Ekip Touch LSIG	1SDA077083R1		1SDA077163R1	
				E1.2B-A 1200 Ekip Hi-Touch LSI	1SDA077085R1		1SDA077165R1	
				E1.2B-A 1200 Ekip Hi-Touch LSIG	1SDA077086R1		1SDA077166R1	
E1.2N-A	800	50	50	E1.2N-A 800 Ekip Dip LI	1SDA077088R1		1SDA077168R1	
				E1.2N-A 800 Ekip Dip LSI	1SDA077089R1		1SDA077169R1	
				E1.2N-A 800 Ekip Dip LSIG	1SDA077090R1		1SDA077170R1	
				E1.2N-A 800 Ekip Touch LI	1SDA077091R1		1SDA077171R1	
				E1.2N-A 800 Ekip Touch LSI	1SDA077092R1		1SDA077172R1	
				E1.2N-A 800 Ekip Touch LSIG	1SDA077093R1		1SDA077173R1	
				E1.2N-A 800 Ekip Hi-Touch LSI	1SDA077095R1		1SDA077175R1	
				E1.2N-A 800 Ekip Hi-Touch LSIG	1SDA077096R1		1SDA077176R1	
	1200	50	50	E1.2N-A 1200 Ekip Dip LI	1SDA077098R1		1SDA077178R1	
				E1.2N-A 1200 Ekip Dip LSI	1SDA077099R1		1SDA077179R1	
				E1.2N-A 1200 Ekip Dip LSIG	1SDA077100R1		1SDA077180R1	
				E1.2N-A 1200 Ekip Touch LI	1SDA077101R1		1SDA077181R1	
				E1.2N-A 1200 Ekip Touch LSI	1SDA077102R1		1SDA077183R1	
				E1.2N-A 1200 Ekip Touch LSIG	1SDA077103R1		1SDA077182R1	
				E1.2N-A 1200 Ekip Hi-Touch LSI	1SDA077105R1		1SDA077185R1	
				E1.2N-A 1200 Ekip Hi-Touch LSIG	1SDA077106R1		1SDA077186R1	

Automatic circuit breakers

Drawout version for power distribution



SACE Emax 2 E1.2S-A • Mobile part of drawout circuit breaker (MP)

Size	Frame Amps	Int. Rating (kA@508V)	Withstand (kA)	Type	3 Poles		4 Poles	
					Global code		Global code	
E1.2S-A	250	65	50	E1.2S-A 250 Ekip Dip LI	1SDA077108R1		1SDA077188R1	
				E1.2S-A 250 Ekip Dip LSI	1SDA077109R1		1SDA077189R1	
				E1.2S-A 250 Ekip Dip LSIG	1SDA077110R1		1SDA077190R1	
				E1.2S-A 250 Ekip Touch LI	1SDA077111R1		1SDA077191R1	
				E1.2S-A 250 Ekip Touch LSI	1SDA077112R1		1SDA077192R1	
				E1.2S-A 250 Ekip Touch LSIG	1SDA077113R1		1SDA077193R1	
				E1.2S-A 250 Ekip Hi-Touch LSI	1SDA077115R1		1SDA077195R1	
				E1.2S-A 250 Ekip Hi-Touch LSIG	1SDA077116R1		1SDA077196R1	
	400	65	50	E1.2S-A 400 Ekip Dip LI	1SDA077118R1		1SDA077198R1	
				E1.2S-A 400 Ekip Dip LSI	1SDA077119R1		1SDA077199R1	
				E1.2S-A 400 Ekip Dip LSIG	1SDA077120R1		1SDA077200R1	
				E1.2S-A 400 Ekip Touch LI	1SDA077121R1		1SDA077201R1	
				E1.2S-A 400 Ekip Touch LSI	1SDA077122R1		1SDA077202R1	
				E1.2S-A 400 Ekip Touch LSIG	1SDA077123R1		1SDA077203R1	
				E1.2S-A 400 Ekip Hi-Touch LSI	1SDA077125R1		1SDA077205R1	
				E1.2S-A 400 Ekip Hi-Touch LSIG	1SDA077126R1		1SDA077206R1	
	800	65	50	E1.2S-A 800 Ekip Dip LI	1SDA077128R1		1SDA077208R1	
				E1.2S-A 800 Ekip Dip LSI	1SDA077129R1		1SDA077209R1	
				E1.2S-A 800 Ekip Dip LSIG	1SDA077130R1		1SDA077210R1	
				E1.2S-A 800 Ekip Touch LI	1SDA077131R1		1SDA077211R1	
				E1.2S-A 800 Ekip Touch LSI	1SDA077132R1		1SDA077212R1	
				E1.2S-A 800 Ekip Touch LSIG	1SDA077133R1		1SDA077213R1	
				E1.2S-A 800 Ekip Hi-Touch LSI	1SDA077135R1		1SDA077215R1	
				E1.2S-A 800 Ekip Hi-Touch LSIG	1SDA077136R1		1SDA077216R1	
	1200	65	50	E1.2S-A 1200 Ekip Dip LI	1SDA077138R1		1SDA077218R1	
				E1.2S-A 1200 Ekip Dip LSI	1SDA077139R1		1SDA077219R1	
				E1.2S-A 1200 Ekip Dip LSIG	1SDA077140R1		1SDA077220R1	
				E1.2S-A 1200 Ekip Touch LI	1SDA077141R1		1SDA077221R1	
E1.2S-A 1200 Ekip Touch LSI				1SDA077142R1		1SDA077222R1		
E1.2S-A 1200 Ekip Touch LSIG				1SDA077143R1		1SDA077223R1		
E1.2S-A 1200 Ekip Hi-Touch LSI				1SDA077145R1		1SDA077225R1		
E1.2S-A 1200 Ekip Hi-Touch LSIG				1SDA077146R1		1SDA077226R1		



1SDC200866F001_LL

SACE Emax 2 E2.2B-A/N-A • Mobile part of drawout circuit breaker (MP)

Size	Frame Amps	Int. Rating (kA@508V)	Withstand (kA)	Type	3 Poles		4 Poles		
					Global code		Global code		
E2.2B-A	1600	42	42	E2.2B-A 1600 Ekip Dip LI	1SDA077568R1		1SDA077738R1		
				E2.2B-A 1600 Ekip Dip LSI	1SDA077569R1		1SDA077739R1		
				E2.2B-A 1600 Ekip Dip LSIG	1SDA077570R1		1SDA077740R1		
				E2.2B-A 1600 Ekip Touch LI	1SDA077571R1		1SDA077741R1		
				E2.2B-A 1600 Ekip Touch LSI	1SDA077572R1		1SDA077742R1		
				E2.2B-A 1600 Ekip Touch LSIG	1SDA077573R1		1SDA077743R1		
				E2.2B-A 1600 Ekip Hi-Touch LSI	1SDA077575R1		1SDA077745R1		
				E2.2B-A 1600 Ekip Hi-Touch LSIG	1SDA077576R1		1SDA077746R1		
E2.2N-A	1600	50	50	E2.2N-A 1600 Ekip Dip LI	1SDA077618R1		1SDA077788R1		
				E2.2N-A 1600 Ekip Dip LSI	1SDA077619R1		1SDA077789R1		
				E2.2N-A 1600 Ekip Dip LSIG	1SDA077620R1		1SDA077790R1		
				E2.2N-A 1600 Ekip Touch LI	1SDA077621R1		1SDA077791R1		
				E2.2N-A 1600 Ekip Touch LSI	1SDA077622R1		1SDA077792R1		
				E2.2N-A 1600 Ekip Touch LSIG	1SDA077623R1		1SDA077793R1		
				E2.2N-A 1600 Ekip Hi-Touch LSI	1SDA077625R1		1SDA077795R1		
				E2.2N-A 1600 Ekip Hi-Touch LSIG	1SDA077626R1		1SDA077796R1		
	2000	50	50	50	E2.2N-A 2000 Ekip Dip LI	1SDA077628R1		1SDA077798R1	
					E2.2N-A 2000 Ekip Dip LSI	1SDA077629R1		1SDA077799R1	
					E2.2N-A 2000 Ekip Dip LSIG	1SDA077630R1		1SDA077800R1	
					E2.2N-A 2000 Ekip Touch LI	1SDA077631R1		1SDA077801R1	
					E2.2N-A 2000 Ekip Touch LSI	1SDA077632R1		1SDA077802R1	
					E2.2N-A 2000 Ekip Touch LSIG	1SDA077633R1		1SDA077803R1	
					E2.2N-A 2000 Ekip Hi-Touch LSI	1SDA077635R1		1SDA077805R1	
					E2.2N-A 2000 Ekip Hi-Touch LSIG	1SDA077636R1		1SDA077806R1	

Automatic circuit breakers

Drawout version for power distribution



SACE Emax 2 E2.2S-A • Mobile part of drawout circuit breaker (MP)

Size	Frame Amps	Int. Rating (kA@508V)	Withstand (kA)	Type	3 Poles		4 Poles	
					Global code		Global code	
E2.2S-A	800	65	65	E2.2S-A 800 Ekip Dip LI	1SDA077638R1		1SDA077808R1	
				E2.2S-A 800 Ekip Dip LSI	1SDA077639R1		1SDA077809R1	
				E2.2S-A 800 Ekip Dip LSIG	1SDA077640R1		1SDA077810R1	
				E2.2S-A 800 Ekip Touch LI	1SDA077641R1		1SDA077811R1	
				E2.2S-A 800 Ekip Touch LSI	1SDA077642R1		1SDA077812R1	
				E2.2S-A 800 Ekip Touch LSIG	1SDA077643R1		1SDA077813R1	
				E2.2S-A 800 Ekip Hi-Touch LSI	1SDA077645R1		1SDA077815R1	
				E2.2S-A 800 Ekip Hi-Touch LSIG	1SDA077646R1		1SDA077816R1	
	1200	65	65	E2.2S-A 1200 Ekip Dip LI	1SDA077648R1		1SDA077818R1	
				E2.2S-A 1200 Ekip Dip LSI	1SDA077649R1		1SDA077819R1	
				E2.2S-A 1200 Ekip Dip LSIG	1SDA077650R1		1SDA077820R1	
				E2.2S-A 1200 Ekip Touch LI	1SDA077651R1		1SDA077821R1	
				E2.2S-A 1200 Ekip Touch LSI	1SDA077652R1		1SDA077822R1	
				E2.2S-A 1200 Ekip Touch LSIG	1SDA077653R1		1SDA077823R1	
				E2.2S-A 1200 Ekip Hi-Touch LSI	1SDA077655R1		1SDA077825R1	
				E2.2S-A 1200 Ekip Hi-Touch LSIG	1SDA077656R1		1SDA077826R1	
	1600	65	65	E2.2S-A 1600 Ekip Dip LI	1SDA077658R1		1SDA077828R1	
				E2.2S-A 1600 Ekip Dip LSI	1SDA077659R1		1SDA077829R1	
				E2.2S-A 1600 Ekip Dip LSIG	1SDA077660R1		1SDA077830R1	
				E2.2S-A 1600 Ekip Touch LI	1SDA077661R1		1SDA077831R1	
				E2.2S-A 1600 Ekip Touch LSI	1SDA077662R1		1SDA077832R1	
				E2.2S-A 1600 Ekip Touch LSIG	1SDA077663R1		1SDA077833R1	
				E2.2S-A 1600 Ekip Hi-Touch LSI	1SDA077665R1		1SDA077835R1	
				E2.2S-A 1600 Ekip Hi-Touch LSIG	1SDA077666R1		1SDA077836R1	
	2000	65	65	E2.2S-A 2000 Ekip Dip LI	1SDA077668R1		1SDA077838R1	
				E2.2S-A 2000 Ekip Dip LSI	1SDA077669R1		1SDA077839R1	
				E2.2S-A 2000 Ekip Dip LSIG	1SDA077670R1		1SDA077840R1	
				E2.2S-A 2000 Ekip Touch LI	1SDA077671R1		1SDA077841R1	
E2.2S-A 2000 Ekip Touch LSI				1SDA077672R1		1SDA077842R1		
E2.2S-A 2000 Ekip Touch LSIG				1SDA077673R1		1SDA077843R1		
E2.2S-A 2000 Ekip Hi-Touch LSI				1SDA077675R1		1SDA077845R1		
E2.2S-A 2000 Ekip Hi-Touch LSIG				1SDA077676R1		1SDA077846R1		



1SDC200066F001_LL

SACE Emax 2 E2.2H-A • Mobile part of drawout circuit breaker (MP)

Size	Frame Amps	Int. Rating (kA@508V)	Withstand (kA)	Type	3 Poles		4 Poles	
					Global code		Global code	
E2.2H-A	800	85	85	E2.2H-A 800 Ekip Dip LI	1SDA077578R1		1SDA077748R1	
				E2.2H-A 800 Ekip Dip LSI	1SDA077579R1		1SDA077749R1	
				E2.2H-A 800 Ekip Dip LSIG	1SDA077580R1		1SDA077750R1	
				E2.2H-A 800 Ekip Touch LI	1SDA077581R1		1SDA077751R1	
				E2.2H-A 800 Ekip Touch LSI	1SDA077582R1		1SDA077752R1	
				E2.2H-A 800 Ekip Touch LSIG	1SDA077583R1		1SDA077753R1	
				E2.2H-A 800 Ekip Hi-Touch LSI	1SDA077585R1		1SDA077755R1	
				E2.2H-A 800 Ekip Hi-Touch LSIG	1SDA077586R1		1SDA077756R1	
	1200	85	85	E2.2H-A 1200 Ekip Dip LI	1SDA077588R1		1SDA077758R1	
				E2.2H-A 1200 Ekip Dip LSI	1SDA077589R1		1SDA077759R1	
				E2.2H-A 1200 Ekip Dip LSIG	1SDA077590R1		1SDA077760R1	
				E2.2H-A 1200 Ekip Touch LI	1SDA077591R1		1SDA077761R1	
				E2.2H-A 1200 Ekip Touch LSI	1SDA077592R1		1SDA077762R1	
				E2.2H-A 1200 Ekip Touch LSIG	1SDA077593R1		1SDA077763R1	
				E2.2H-A 1200 Ekip Hi-Touch LSI	1SDA077595R1		1SDA077765R1	
				E2.2H-A 1200 Ekip Hi-Touch LSIG	1SDA077596R1		1SDA077766R1	
	1600	85	85	E2.2H-A 1600 Ekip Dip LI	1SDA077598R1		1SDA077768R1	
				E2.2H-A 1600 Ekip Dip LSI	1SDA077599R1		1SDA077769R1	
				E2.2H-A 1600 Ekip Dip LSIG	1SDA077600R1		1SDA077770R1	
				E2.2H-A 1600 Ekip Touch LI	1SDA077601R1		1SDA077771R1	
				E2.2H-A 1600 Ekip Touch LSI	1SDA077602R1		1SDA077772R1	
				E2.2H-A 1600 Ekip Touch LSIG	1SDA077603R1		1SDA077773R1	
				E2.2H-A 1600 Ekip Hi-Touch LSI	1SDA077605R1		1SDA077775R1	
				E2.2H-A 1600 Ekip Hi-Touch LSIG	1SDA077606R1		1SDA077776R1	
	2000	85	85	E2.2H-A 2000 Ekip Dip LI	1SDA077608R1		1SDA077778R1	
				E2.2H-A 2000 Ekip Dip LSI	1SDA077609R1		1SDA077779R1	
				E2.2H-A 2000 Ekip Dip LSIG	1SDA077610R1		1SDA077780R1	
				E2.2H-A 2000 Ekip Touch LI	1SDA077611R1		1SDA077781R1	
E2.2H-A 2000 Ekip Touch LSI				1SDA077612R1		1SDA077782R1		
E2.2H-A 2000 Ekip Touch LSIG				1SDA077613R1		1SDA077783R1		
E2.2H-A 2000 Ekip Hi-Touch LSI				1SDA077615R1		1SDA077785R1		
E2.2H-A 2000 Ekip Hi-Touch LSIG				1SDA077616R1		1SDA077786R1		

Automatic circuit breakers

Drawout version for power distribution



SACE Emax 2 E2.2V-A • Mobile part of drawout circuit breaker (MP)

Size	Frame Amps	Int. Rating (kA@508V)	Withstand (kA)	Type	3 Poles		4 Poles	
					Global code		Global code	
E2.2V-A	250	100	85	E2.2V-A 250 Ekip Dip LI	1SDA077678R1		1SDA077848R1	
				E2.2V-A 250 Ekip Dip LSI	1SDA077679R1		1SDA077849R1	
				E2.2V-A 250 Ekip Dip LSIG	1SDA077680R1		1SDA077850R1	
				E2.2V-A 250 Ekip Touch LI	1SDA077681R1		1SDA077851R1	
				E2.2V-A 250 Ekip Touch LSI	1SDA077682R1		1SDA077852R1	
				E2.2V-A 250 Ekip Touch LSIG	1SDA077683R1		1SDA077853R1	
				E2.2V-A 250 Ekip Hi-Touch LSI	1SDA077685R1		1SDA077855R1	
				E2.2V-A 250 Ekip Hi-Touch LSIG	1SDA077686R1		1SDA077856R1	
	400	100	85	E2.2V-A 400 Ekip Dip LI	1SDA077688R1		1SDA077858R1	
				E2.2V-A 400 Ekip Dip LSI	1SDA077689R1		1SDA077859R1	
				E2.2V-A 400 Ekip Dip LSIG	1SDA077690R1		1SDA077860R1	
				E2.2V-A 400 Ekip Touch LI	1SDA077691R1		1SDA077861R1	
				E2.2V-A 400 Ekip Touch LSI	1SDA077692R1		1SDA077862R1	
				E2.2V-A 400 Ekip Touch LSIG	1SDA077693R1		1SDA077863R1	
				E2.2V-A 400 Ekip Hi-Touch LSI	1SDA077695R1		1SDA077865R1	
				E2.2V-A 400 Ekip Hi-Touch LSIG	1SDA077696R1		1SDA077866R1	
	800	100	85	E2.2V-A 800 Ekip Dip LI	1SDA077698R1		1SDA077868R1	
				E2.2V-A 800 Ekip Dip LSI	1SDA077699R1		1SDA077869R1	
				E2.2V-A 800 Ekip Dip LSIG	1SDA077700R1		1SDA077870R1	
				E2.2V-A 800 Ekip Touch LI	1SDA077701R1		1SDA077871R1	
				E2.2V-A 800 Ekip Touch LSI	1SDA077702R1		1SDA077872R1	
				E2.2V-A 800 Ekip Touch LSIG	1SDA077703R1		1SDA077873R1	
				E2.2V-A 800 Ekip Hi-Touch LSI	1SDA077705R1		1SDA077875R1	
				E2.2V-A 800 Ekip Hi-Touch LSIG	1SDA077706R1		1SDA077876R1	
	1200	100	85	E2.2V-A 1200 Ekip Dip LI	1SDA077708R1		1SDA077878R1	
				E2.2V-A 1200 Ekip Dip LSI	1SDA077709R1		1SDA077879R1	
				E2.2V-A 1200 Ekip Dip LSIG	1SDA077710R1		1SDA077880R1	
				E2.2V-A 1200 Ekip Touch LI	1SDA077711R1		1SDA077881R1	
E2.2V-A 1200 Ekip Touch LSI				1SDA077712R1		1SDA077882R1		
E2.2V-A 1200 Ekip Touch LSIG				1SDA077713R1		1SDA077883R1		
E2.2V-A 1200 Ekip Hi-Touch LSI				1SDA077715R1		1SDA077885R1		
E2.2V-A 1200 Ekip Hi-Touch LSIG				1SDA077716R1		1SDA077886R1		
1600	100	85	E2.2V-A 1600 Ekip Dip LI	1SDA077718R1		1SDA077888R1		
			E2.2V-A 1600 Ekip Dip LSI	1SDA077719R1		1SDA077889R1		
			E2.2V-A 1600 Ekip Dip LSIG	1SDA077720R1		1SDA077890R1		
			E2.2V-A 1600 Ekip Touch LI	1SDA077721R1		1SDA077891R1		
			E2.2V-A 1600 Ekip Touch LSI	1SDA077722R1		1SDA077892R1		
			E2.2V-A 1600 Ekip Touch LSIG	1SDA077723R1		1SDA077893R1		
			E2.2V-A 1600 Ekip Hi-Touch LSI	1SDA077725R1		1SDA077895R1		
			E2.2V-A 1600 Ekip Hi-Touch LSIG	1SDA077726R1		1SDA077896R1		
2000	100	85	E2.2V-A 2000 Ekip Dip LI	1SDA077728R1		1SDA077898R1		
			E2.2V-A 2000 Ekip Dip LSI	1SDA077729R1		1SDA077899R1		
			E2.2V-A 2000 Ekip Dip LSIG	1SDA077730R1		1SDA077900R1		
			E2.2V-A 2000 Ekip Touch LI	1SDA077731R1		1SDA077901R1		
			E2.2V-A 2000 Ekip Touch LSI	1SDA077732R1		1SDA077902R1		
			E2.2V-A 2000 Ekip Touch LSIG	1SDA077733R1		1SDA077903R1		
			E2.2V-A 2000 Ekip Hi-Touch LSI	1SDA077735R1		1SDA077905R1		
			E2.2V-A 2000 Ekip Hi-Touch LSIG	1SDA077736R1		1SDA077906R1		



1SDC200067F001_UL

SACE Emax 2 E4.2S-A/H-A • Mobile part of drawout circuit breaker (MP)

Size	Frame Amps	Int. Rating (kA@508V)	Withstand (kA)	Type	3 Poles		4 Poles	
					Global code		Global code	
E4.2S-A	2500	65	65	E4.2S-A 2500 Ekip Dip LI	1SDA078458R1		1SDA078688R1	
				E4.2S-A 2500 Ekip Dip LSI	1SDA078459R1		1SDA078689R1	
				E4.2S-A 2500 Ekip Dip LSIG	1SDA078460R1		1SDA078690R1	
				E4.2S-A 2500 Ekip Touch LI	1SDA078461R1		1SDA078691R1	
				E4.2S-A 2500 Ekip Touch LSI	1SDA078462R1		1SDA078692R1	
				E4.2S-A 2500 Ekip Touch LSIG	1SDA078463R1		1SDA078693R1	
				E4.2S-A 2500 Ekip Hi-Touch LSI	1SDA078465R1		1SDA078695R1	
	E4.2S-A 2500 Ekip Hi-Touch LSIG	1SDA078466R1		1SDA078696R1				
	3200	65	65	E4.2S-A 3200 Ekip Dip LI	1SDA078468R1		1SDA078698R1	
				E4.2S-A 3200 Ekip Dip LSI	1SDA078469R1		1SDA078699R1	
				E4.2S-A 3200 Ekip Dip LSIG	1SDA078470R1		1SDA078700R1	
				E4.2S-A 3200 Ekip Touch LI	1SDA078471R1		1SDA078701R1	
				E4.2S-A 3200 Ekip Touch LSI	1SDA078472R1		1SDA078702R1	
				E4.2S-A 3200 Ekip Touch LSIG	1SDA078473R1		1SDA078703R1	
E4.2S-A 3200 Ekip Hi-Touch LSI				1SDA078475R1		1SDA078705R1		
E4.2S-A 3200 Ekip Hi-Touch LSIG	1SDA078476R1		1SDA078706R1					
E4.2H-A	2500	85	85	E4.2H-A 2500 Ekip Dip LI	1SDA078368R1		1SDA078598R1	
				E4.2H-A 2500 Ekip Dip LSI	1SDA078369R1		1SDA078599R1	
				E4.2H-A 2500 Ekip Dip LSIG	1SDA078370R1		1SDA078600R1	
				E4.2H-A 2500 Ekip Touch LI	1SDA078371R1		1SDA078601R1	
				E4.2H-A 2500 Ekip Touch LSI	1SDA078372R1		1SDA078602R1	
				E4.2H-A 2500 Ekip Touch LSIG	1SDA078373R1		1SDA078603R1	
				E4.2H-A 2500 Ekip Hi-Touch LSI	1SDA078375R1		1SDA078605R1	
	E4.2H-A 2500 Ekip Hi-Touch LSIG	1SDA078376R1		1SDA078606R1				
	3200	85	85	E4.2H-A 3200 Ekip Dip LI	1SDA078378R1		1SDA078608R1	
				E4.2H-A 3200 Ekip Dip LSI	1SDA078379R1		1SDA078609R1	
				E4.2H-A 3200 Ekip Dip LSIG	1SDA078380R1		1SDA078610R1	
				E4.2H-A 3200 Ekip Touch LI	1SDA078381R1		1SDA078611R1	
				E4.2H-A 3200 Ekip Touch LSI	1SDA078382R1		1SDA078612R1	
				E4.2H-A 3200 Ekip Touch LSIG	1SDA078383R1		1SDA078613R1	
E4.2H-A 3200 Ekip Hi-Touch LSI				1SDA078385R1		1SDA078615R1		
E4.2H-A 3200 Ekip Hi-Touch LSIG	1SDA078386R1		1SDA078616R1					

Automatic circuit breakers

Drawout version for power distribution



SACE Emax 2 E4.2V-A • Mobile part of drawout circuit breaker (MP)

Size	Frame Amps	Int. Rating (kA@508V)	Withstand (kA)	Type	3 Poles		4 Poles	
					Global code		Global code	
E4.2V-A	800	100	85	E4.2V-A 800 Ekip Dip LI	1SDA078488R1		1SDA078718R1	
				E4.2V-A 800 Ekip Dip LSI	1SDA078489R1		1SDA078719R1	
				E4.2V-A 800 Ekip Dip LSIG	1SDA078490R1		1SDA078720R1	
				E4.2V-A 800 Ekip Touch LI	1SDA078491R1		1SDA078721R1	
				E4.2V-A 800 Ekip Touch LSI	1SDA078492R1		1SDA078722R1	
				E4.2V-A 800 Ekip Touch LSIG	1SDA078493R1		1SDA078723R1	
				E4.2V-A 800 Ekip Hi-Touch LSI	1SDA078495R1		1SDA078725R1	
				E4.2V-A 800 Ekip Hi-Touch LSIG	1SDA078496R1		1SDA078726R1	
	1600	100	85	E4.2V-A 1600 Ekip Dip LI	1SDA078498R1		1SDA078728R1	
				E4.2V-A 1600 Ekip Dip LSI	1SDA078499R1		1SDA078729R1	
				E4.2V-A 1600 Ekip Dip LSIG	1SDA078500R1		1SDA078730R1	
				E4.2V-A 1600 Ekip Touch LI	1SDA078501R1		1SDA078731R1	
				E4.2V-A 1600 Ekip Touch LSI	1SDA078502R1		1SDA078732R1	
				E4.2V-A 1600 Ekip Touch LSIG	1SDA078503R1		1SDA078733R1	
				E4.2V-A 1600 Ekip Hi-Touch LSI	1SDA078505R1		1SDA078735R1	
				E4.2V-A 1600 Ekip Hi-Touch LSIG	1SDA078506R1		1SDA078736R1	
	2000	100	85	E4.2V-A 2000 Ekip Dip LI	1SDA078508R1		1SDA078738R1	
				E4.2V-A 2000 Ekip Dip LSI	1SDA078509R1		1SDA078739R1	
				E4.2V-A 2000 Ekip Dip LSIG	1SDA078510R1		1SDA078740R1	
				E4.2V-A 2000 Ekip Touch LI	1SDA078511R1		1SDA078741R1	
				E4.2V-A 2000 Ekip Touch LSI	1SDA078512R1		1SDA078742R1	
				E4.2V-A 2000 Ekip Touch LSIG	1SDA078513R1		1SDA078743R1	
				E4.2V-A 2000 Ekip Hi-Touch LSI	1SDA078515R1		1SDA078745R1	
				E4.2V-A 2000 Ekip Hi-Touch LSIG	1SDA078516R1		1SDA078746R1	
	2500	100	85	E4.2V-A 2500 Ekip Dip LI	1SDA078518R1		1SDA078748R1	
				E4.2V-A 2500 Ekip Dip LSI	1SDA078519R1		1SDA078749R1	
				E4.2V-A 2500 Ekip Dip LSIG	1SDA078520R1		1SDA078750R1	
				E4.2V-A 2500 Ekip Touch LI	1SDA078521R1		1SDA078751R1	
E4.2V-A 2500 Ekip Touch LSI				1SDA078522R1		1SDA078752R1		
E4.2V-A 2500 Ekip Touch LSIG				1SDA078523R1		1SDA078753R1		
E4.2V-A 2500 Ekip Hi-Touch LSI				1SDA078525R1		1SDA078755R1		
E4.2V-A 2500 Ekip Hi-Touch LSIG				1SDA078526R1		1SDA078756R1		
3200	100	85	E4.2V-A 3200 Ekip Dip LI	1SDA078528R1		1SDA078758R1		
			E4.2V-A 3200 Ekip Dip LSI	1SDA078529R1		1SDA078759R1		
			E4.2V-A 3200 Ekip Dip LSIG	1SDA078530R1		1SDA078760R1		
			E4.2V-A 3200 Ekip Touch LI	1SDA078531R1		1SDA078761R1		
			E4.2V-A 3200 Ekip Touch LSI	1SDA078532R1		1SDA078762R1		
			E4.2V-A 3200 Ekip Touch LSIG	1SDA078533R1		1SDA078763R1		
			E4.2V-A 3200 Ekip Hi-Touch LSI	1SDA078535R1		1SDA078765R1		
			E4.2V-A 3200 Ekip Hi-Touch LSIG	1SDA078536R1		1SDA078766R1		



1SDC200067F001_U0

SACE Emax 2 E4.2L-A • Mobile part of drawout circuit breaker (MP)

Size	Frame Amps	Int. Rating (kA@508V)	Withstand (kA)	Type	3 Poles		4 Poles	
					Global code		Global code	
E4.2L-A	800	125	100	E4.2L-A 800 Ekip Dip LI	1SDA078398R1		1SDA078628R1	
				E4.2L-A 800 Ekip Dip LSI	1SDA078399R1		1SDA078629R1	
				E4.2L-A 800 Ekip Dip LSIG	1SDA078400R1		1SDA078630R1	
				E4.2L-A 800 Ekip Touch LI	1SDA078401R1		1SDA078631R1	
				E4.2L-A 800 Ekip Touch LSI	1SDA078402R1		1SDA078632R1	
				E4.2L-A 800 Ekip Touch LSIG	1SDA078403R1		1SDA078633R1	
				E4.2L-A 800 Ekip Hi-Touch LSI	1SDA078405R1		1SDA078635R1	
				E4.2L-A 800 Ekip Hi-Touch LSIG	1SDA078406R1		1SDA078636R1	
	1600	125	100	E4.2L-A 1600 Ekip Dip LI	1SDA078408R1		1SDA078638R1	
				E4.2L-A 1600 Ekip Dip LSI	1SDA078409R1		1SDA078639R1	
				E4.2L-A 1600 Ekip Dip LSIG	1SDA078410R1		1SDA078640R1	
				E4.2L-A 1600 Ekip Touch LI	1SDA078411R1		1SDA078641R1	
				E4.2L-A 1600 Ekip Touch LSI	1SDA078412R1		1SDA078642R1	
				E4.2L-A 1600 Ekip Touch LSIG	1SDA078413R1		1SDA078643R1	
				E4.2L-A 1600 Ekip Hi-Touch LSI	1SDA078415R1		1SDA078645R1	
				E4.2L-A 1600 Ekip Hi-Touch LSIG	1SDA078416R1		1SDA078646R1	
	2000	125	100	E4.2L-A 2000 Ekip Dip LI	1SDA078418R1		1SDA078648R1	
				E4.2L-A 2000 Ekip Dip LSI	1SDA078419R1		1SDA078649R1	
				E4.2L-A 2000 Ekip Dip LSIG	1SDA078420R1		1SDA078650R1	
				E4.2L-A 2000 Ekip Touch LI	1SDA078421R1		1SDA078651R1	
				E4.2L-A 2000 Ekip Touch LSI	1SDA078422R1		1SDA078652R1	
				E4.2L-A 2000 Ekip Touch LSIG	1SDA078423R1		1SDA078653R1	
				E4.2L-A 2000 Ekip Hi-Touch LSI	1SDA078425R1		1SDA078655R1	
				E4.2L-A 2000 Ekip Hi-Touch LSIG	1SDA078426R1		1SDA078656R1	
	2500	125	100	E4.2L-A 2500 Ekip Dip LI	1SDA078428R1		1SDA078658R1	
				E4.2L-A 2500 Ekip Dip LSI	1SDA078429R1		1SDA078659R1	
				E4.2L-A 2500 Ekip Dip LSIG	1SDA078430R1		1SDA078660R1	
				E4.2L-A 2500 Ekip Touch LI	1SDA078431R1		1SDA078661R1	
E4.2L-A 2500 Ekip Touch LSI				1SDA078432R1		1SDA078662R1		
E4.2L-A 2500 Ekip Touch LSIG				1SDA078433R1		1SDA078663R1		
E4.2L-A 2500 Ekip Hi-Touch LSI				1SDA078435R1		1SDA078665R1		
E4.2L-A 2500 Ekip Hi-Touch LSIG				1SDA078436R1		1SDA078666R1		
3200	125	100	E4.2L-A 3200 Ekip Dip LI	1SDA078438R1		1SDA078668R1		
			E4.2L-A 3200 Ekip Dip LSI	1SDA078439R1		1SDA078669R1		
			E4.2L-A 3200 Ekip Dip LSIG	1SDA078440R1		1SDA078670R1		
			E4.2L-A 3200 Ekip Touch LI	1SDA078441R1		1SDA078671R1		
			E4.2L-A 3200 Ekip Touch LSI	1SDA078442R1		1SDA078672R1		
			E4.2L-A 3200 Ekip Touch LSIG	1SDA078443R1		1SDA078673R1		
			E4.2L-A 3200 Ekip Hi-Touch LSI	1SDA078445R1		1SDA078675R1		
			E4.2L-A 3200 Ekip Hi-Touch LSIG	1SDA078446R1		1SDA078676R1		

Automatic circuit breakers

Drawout version for power distribution



SACE Emax 2 E4.2X-A • Mobile part of drawout circuit breaker (MP)

Size	Frame Amps	Int. Rating (kA@508V)	Withstand (kA)	Type	3 Poles		4 Poles	
					Global code		Global code	
E4.2X-A (*)	1600	200	50	E4.2X-A 1600 Ekip Dip LI	1SDA078548R1		1SDA078778R1	
				E4.2X-A 1600 Ekip Dip LSI	1SDA078549R1		1SDA078779R1	
				E4.2X-A 1600 Ekip Dip LSIG	1SDA078550R1		1SDA078780R1	
				E4.2X-A 1600 Ekip Touch LI	1SDA078551R1		1SDA078781R1	
				E4.2X-A 1600 Ekip Touch LSI	1SDA078552R1		1SDA078782R1	
				E4.2X-A 1600 Ekip Touch LSIG	1SDA078553R1		1SDA078783R1	
				E4.2X-A 1600 Ekip Hi-Touch LSI	1SDA078555R1		1SDA078785R1	
				E4.2X-A 1600 Ekip Hi-Touch LSIG	1SDA078556R1		1SDA078786R1	
	2000	200	50	E4.2X-A 2000 Ekip Dip LI	1SDA078558R1		1SDA078789R1	
				E4.2X-A 2000 Ekip Dip LSI	1SDA078559R1		1SDA078789R1	
				E4.2X-A 2000 Ekip Dip LSIG	1SDA078560R1		1SDA078790R1	
				E4.2X-A 2000 Ekip Touch LI	1SDA078561R1		1SDA078791R1	
				E4.2X-A 2000 Ekip Touch LSI	1SDA078562R1		1SDA078792R1	
				E4.2X-A 2000 Ekip Touch LSIG	1SDA078563R1		1SDA078793R1	
				E4.2X-A 2000 Ekip Hi-Touch LSI	1SDA078565R1		1SDA078795R1	
				E4.2X-A 2000 Ekip Hi-Touch LSIG	1SDA078566R1		1SDA078796R1	
	2500	200	50	E4.2X-A 2500 Ekip Dip LI	1SDA078568R1		1SDA078798R1	
				E4.2X-A 2500 Ekip Dip LSI	1SDA078569R1		1SDA078799R1	
				E4.2X-A 2500 Ekip Dip LSIG	1SDA078570R1		1SDA078800R1	
				E4.2X-A 2500 Ekip Touch LI	1SDA078571R1		1SDA078801R1	
				E4.2X-A 2500 Ekip Touch LSI	1SDA078572R1		1SDA078802R1	
				E4.2X-A 2500 Ekip Touch LSIG	1SDA078573R1		1SDA078803R1	
				E4.2X-A 2500 Ekip Hi-Touch LSI	1SDA078575R1		1SDA078805R1	
				E4.2X-A 2500 Ekip Hi-Touch LSIG	1SDA078576R1		1SDA078806R1	
	3200	200	50	E4.2X-A 3200 Ekip Dip LI	1SDA078578R1		1SDA078808R1	
				E4.2X-A 3200 Ekip Dip LSI	1SDA078579R1		1SDA078809R1	
				E4.2X-A 3200 Ekip Dip LSIG	1SDA078580R1		1SDA078810R1	
				E4.2X-A 3200 Ekip Touch LI	1SDA078581R1		1SDA078811R1	
E4.2X-A 3200 Ekip Touch LSI				1SDA078582R1		1SDA078812R1		
E4.2X-A 3200 Ekip Touch LSIG				1SDA078583R1		1SDA078813R1		
E4.2X-A 3200 Ekip Hi-Touch LSI				1SDA078585R1		1SDA078815R1		
E4.2X-A 3200 Ekip Hi-Touch LSIG				1SDA078586R1		1SDA078816R1		

* Version not yet available. Contact ABB



SACE Emax 2 E6.2H-A/V-A • Mobile part of drawout circuit breaker (MP)

Size	Frame Amps	Int. Rating (kA@508V)	Withstand (kA)	Type	3 Poles		4 Poles		
					Global code		Global code		
E6.2H-A	4000	85	85	E6.2H-A 4000 Ekip Dip LI	1SDA079068R1		1SDA079188R1		
				E6.2H-A 4000 Ekip Dip LSI	1SDA079069R1		1SDA079189R1		
				E6.2H-A 4000 Ekip Dip LSIG	1SDA079070R1		1SDA079190R1		
				E6.2H-A 4000 Ekip Touch LI	1SDA079071R1		1SDA079191R1		
				E6.2H-A 4000 Ekip Touch LSI	1SDA079072R1		1SDA079192R1		
				E6.2H-A 4000 Ekip Touch LSIG	1SDA079073R1		1SDA079193R1		
				E6.2H-A 4000 Ekip Hi-Touch LSI	1SDA079075R1		1SDA079195R1		
				E6.2H-A 4000 Ekip Hi-Touch LSIG	1SDA079076R1		1SDA079196R1		
	5000	85	85	E6.2H-A 5000 Ekip Dip LI	1SDA079078R1		1SDA079198R1		
				E6.2H-A 5000 Ekip Dip LSI	1SDA079079R1		1SDA079199R1		
				E6.2H-A 5000 Ekip Dip LSIG	1SDA079080R1		1SDA079200R1		
				E6.2H-A 5000 Ekip Touch LI	1SDA079081R1		1SDA079201R1		
				E6.2H-A 5000 Ekip Touch LSI	1SDA079082R1		1SDA079202R1		
				E6.2H-A 5000 Ekip Touch LSIG	1SDA079083R1		1SDA079203R1		
				E6.2H-A 5000 Ekip Hi-Touch LSI	1SDA079085R1		1SDA079205R1		
				E6.2H-A 5000 Ekip Hi-Touch LSIG	1SDA079086R1		1SDA079206R1		
	6000 (*)	85	85	E6.2H-A 6000 Ekip Dip LI	1SDA079088R1		1SDA079208R1		
				E6.2H-A 6000 Ekip Dip LSI	1SDA079089R1		1SDA079209R1		
				E6.2H-A 6000 Ekip Dip LSIG	1SDA079090R1		1SDA079210R1		
				E6.2H-A 6000 Ekip Touch LI	1SDA079091R1		1SDA079211R1		
				E6.2H-A 6000 Ekip Touch LSI	1SDA079092R1		1SDA079212R1		
				E6.2H-A 6000 Ekip Touch LSIG	1SDA079093R1		1SDA079213R1		
				E6.2H-A 6000 Ekip Hi-Touch LSI	1SDA079095R1		1SDA079215R1		
				E6.2H-A 6000 Ekip Hi-Touch LSIG	1SDA079096R1		1SDA079216R1		
	E6.2V-A	4000	100	100	E6.2V-A 4000 Ekip Dip LI	1SDA079128R1		1SDA079248R1	
					E6.2V-A 4000 Ekip Dip LSI	1SDA079129R1		1SDA079249R1	
					E6.2V-A 4000 Ekip Dip LSIG	1SDA079130R1		1SDA079250R1	
					E6.2V-A 4000 Ekip Touch LI	1SDA079131R1		1SDA079251R1	
E6.2V-A 4000 Ekip Touch LSI					1SDA079132R1		1SDA079252R1		
E6.2V-A 4000 Ekip Touch LSIG					1SDA079133R1		1SDA079253R1		
E6.2V-A 4000 Ekip Hi-Touch LSI					1SDA079135R1		1SDA079255R1		
E6.2V-A 4000 Ekip Hi-Touch LSIG					1SDA079136R1		1SDA079256R1		
5000		100	100	E6.2V-A 5000 Ekip Dip LI	1SDA079138R1		1SDA079258R1		
				E6.2V-A 5000 Ekip Dip LSI	1SDA079139R1		1SDA079259R1		
				E6.2V-A 5000 Ekip Dip LSIG	1SDA079140R1		1SDA079260R1		
				E6.2V-A 5000 Ekip Touch LI	1SDA079141R1		1SDA079261R1		
				E6.2V-A 5000 Ekip Touch LSI	1SDA079142R1		1SDA079262R1		
				E6.2V-A 5000 Ekip Touch LSIG	1SDA079143R1		1SDA079263R1		
				E6.2V-A 5000 Ekip Hi-Touch LSI	1SDA079145R1		1SDA079265R1		
				E6.2V-A 5000 Ekip Hi-Touch LSIG	1SDA079146R1		1SDA079266R1		
6000 (*)		100	100	E6.2V-A 6000 Ekip Dip LI	1SDA079148R1		1SDA079268R1		
				E6.2V-A 6000 Ekip Dip LSI	1SDA079149R1		1SDA079269R1		
				E6.2V-A 6000 Ekip Dip LSIG	1SDA079150R1		1SDA079270R1		
				E6.2V-A 6000 Ekip Touch LI	1SDA079151R1		1SDA079271R1		
				E6.2V-A 6000 Ekip Touch LSI	1SDA079152R1		1SDA079272R1		
				E6.2V-A 6000 Ekip Touch LSIG	1SDA079153R1		1SDA079273R1		
				E6.2V-A 6000 Ekip Hi-Touch LSI	1SDA079155R1		1SDA079275R1		
				E6.2V-A 6000 Ekip Hi-Touch LSIG	1SDA079156R1		1SDA079276R1		

* Version not yet available. Contact ABB

Automatic circuit breakers

Drawout version for power distribution



SACE Emax 2 E6.2L-A/X-A • Mobile part of drawout circuit breaker (MP)

Size	Frame Amps	Int. Rating (kA@508V)	Withstand (kA)	Type	3 Poles		4 Poles		
					Global code		Global code		
E6.2L-A	4000	150	100	E6.2L-A 4000 Ekip Dip LI	1SDA079098R1		1SDA079218R1		
				E6.2L-A 4000 Ekip Dip LSI	1SDA079099R1		1SDA079219R1		
				E6.2L-A 4000 Ekip Dip LSIG	1SDA079100R1		1SDA079220R1		
				E6.2L-A 4000 Ekip Touch LI	1SDA079101R1		1SDA079221R1		
				E6.2L-A 4000 Ekip Touch LSI	1SDA079102R1		1SDA079222R1		
				E6.2L-A 4000 Ekip Touch LSIG	1SDA079103R1		1SDA079223R1		
				E6.2L-A 4000 Ekip Hi-Touch LSI	1SDA079105R1		1SDA079225R1		
				E6.2L-A 4000 Ekip Hi-Touch LSIG	1SDA079106R1		1SDA079226R1		
	5000	150	100	E6.2L-A 5000 Ekip Dip LI	1SDA079108R1		1SDA079228R1		
				E6.2L-A 5000 Ekip Dip LSI	1SDA079109R1		1SDA079229R1		
				E6.2L-A 5000 Ekip Dip LSIG	1SDA079110R1		1SDA079230R1		
				E6.2L-A 5000 Ekip Touch LI	1SDA079111R1		1SDA079231R1		
				E6.2L-A 5000 Ekip Touch LSI	1SDA079112R1		1SDA079232R1		
				E6.2L-A 5000 Ekip Touch LSIG	1SDA079113R1		1SDA079233R1		
				E6.2L-A 5000 Ekip Hi-Touch LSI	1SDA079115R1		1SDA079235R1		
				E6.2L-A 5000 Ekip Hi-Touch LSIG	1SDA079116R1		1SDA079236R1		
	6000 (*)	150	100	E6.2L-A 6000 Ekip Dip LI	1SDA079118R1		1SDA079238R1		
				E6.2L-A 6000 Ekip Dip LSI	1SDA079119R1		1SDA079239R1		
				E6.2L-A 6000 Ekip Dip LSIG	1SDA079120R1		1SDA079240R1		
				E6.2L-A 6000 Ekip Touch LI	1SDA079121R1		1SDA079241R1		
				E6.2L-A 6000 Ekip Touch LSI	1SDA079122R1		1SDA079242R1		
				E6.2L-A 6000 Ekip Touch LSIG	1SDA079123R1		1SDA079243R1		
				E6.2L-A 6000 Ekip Hi-Touch LSI	1SDA079125R1		1SDA079245R1		
				E6.2L-A 6000 Ekip Hi-Touch LSIG	1SDA079126R1		1SDA079246R1		
	E6.2X-A (*)	4000	200	100	E6.2X-A 4000 Ekip Dip LI	1SDA079158R1		1SDA079278R1	
					E6.2X-A 4000 Ekip Dip LSI	1SDA079159R1		1SDA079279R1	
					E6.2X-A 4000 Ekip Dip LSIG	1SDA079160R1		1SDA079280R1	
					E6.2X-A 4000 Ekip Touch LI	1SDA079161R1		1SDA079281R1	
E6.2X-A 4000 Ekip Touch LSI					1SDA079162R1		1SDA079282R1		
E6.2X-A 4000 Ekip Touch LSIG					1SDA079163R1		1SDA079283R1		
E6.2X-A 4000 Ekip Hi-Touch LSI					1SDA079165R1		1SDA079285R1		
E6.2X-A 4000 Ekip Hi-Touch LSIG					1SDA079166R1		1SDA079286R1		
5000		200	100	E6.2X-A 5000 Ekip Dip LI	1SDA079168R1		1SDA079288R1		
				E6.2X-A 5000 Ekip Dip LSI	1SDA079169R1		1SDA079289R1		
				E6.2X-A 5000 Ekip Dip LSIG	1SDA079170R1		1SDA079290R1		
				E6.2X-A 5000 Ekip Touch LI	1SDA079171R1		1SDA079291R1		
				E6.2X-A 5000 Ekip Touch LSI	1SDA079172R1		1SDA079292R1		
				E6.2X-A 5000 Ekip Touch LSIG	1SDA079173R1		1SDA079293R1		
				E6.2X-A 5000 Ekip Hi-Touch LSI	1SDA079175R1		1SDA079295R1		
				E6.2X-A 5000 Ekip Hi-Touch LSIG	1SDA079176R1		1SDA079296R1		
6000 (*)		200	100	E6.2X-A 6000 Ekip Dip LI	1SDA079178R1		1SDA079298R1		
				E6.2X-A 6000 Ekip Dip LSI	1SDA079179R1		1SDA079299R1		
				E6.2X-A 6000 Ekip Dip LSIG	1SDA079180R1		1SDA079300R1		
				E6.2X-A 6000 Ekip Touch LI	1SDA079181R1		1SDA079301R1		
				E6.2X-A 6000 Ekip Touch LSI	1SDA079182R1		1SDA079302R1		
				E6.2X-A 6000 Ekip Touch LSIG	1SDA079183R1		1SDA079303R1		
				E6.2X-A 6000 Ekip Hi-Touch LSI	1SDA079185R1		1SDA079305R1		
				E6.2X-A 6000 Ekip Hi-Touch LSIG	1SDA079186R1		1SDA079306R1		

* Version not yet available. Contact ABB



1SDC20068F001_LUL

SACE Emax 2 E6.2H-A/f/V-A/f • Mobile part of drawout circuit breaker (MP)

Size	Frame Amps	Int. Rating (kA@508V)	Withstand (kA)	Type	4 Poles		
					Global code		
E6.2H-A/f	4000	85	85	E6.2H-A/f 4000 Ekip Dip LI	1SDA079428R1		
				E6.2H-A/f 4000 Ekip Dip LSI	1SDA079429R1		
				E6.2H-A/f 4000 Ekip Dip LSIG	1SDA079430R1		
				E6.2H-A/f 4000 Ekip Touch LI	1SDA079431R1		
				E6.2H-A/f 4000 Ekip Touch LSI	1SDA079432R1		
				E6.2H-A/f 4000 Ekip Touch LSIG	1SDA079433R1		
				E6.2H-A/f 4000 Ekip Hi-Touch LSI	1SDA079435R1		
				E6.2H-A/f 4000 Ekip Hi-Touch LSIG	1SDA079436R1		
				5000	85	85	E6.2H-A/f 5000 Ekip Dip LI
	E6.2H-A/f 5000 Ekip Dip LSI	1SDA079439R1					
	E6.2H-A/f 5000 Ekip Dip LSIG	1SDA079440R1					
	E6.2H-A/f 5000 Ekip Touch LI	1SDA079441R1					
	E6.2H-A/f 5000 Ekip Touch LSI	1SDA079442R1					
	E6.2H-A/f 5000 Ekip Touch LSIG	1SDA079443R1					
	E6.2H-A/f 5000 Ekip Hi-Touch LSI	1SDA079445R1					
	E6.2H-A/f 5000 Ekip Hi-Touch LSIG	1SDA079446R1					
	6000 (*)	85	85				E6.2H-A/f 6000 Ekip Dip LI
				E6.2H-A/f 6000 Ekip Dip LSI	1SDA079449R1		
				E6.2H-A/f 6000 Ekip Dip LSIG	1SDA079450R1		
				E6.2H-A/f 6000 Ekip Touch LI	1SDA079451R1		
				E6.2H-A/f 6000 Ekip Touch LSI	1SDA079452R1		
				E6.2H-A/f 6000 Ekip Touch LSIG	1SDA079453R1		
				E6.2H-A/f 6000 Ekip Hi-Touch LSI	1SDA079455R1		
				E6.2H-A/f 6000 Ekip Hi-Touch LSIG	1SDA079456R1		
				E6.2V-A/f	4000	100	100
	E6.2V-A/f 4000 Ekip Dip LSI	1SDA079489R1					
	E6.2V-A/f 4000 Ekip Dip LSIG	1SDA079490R1					
E6.2V-A/f 4000 Ekip Touch LI	1SDA079491R1						
E6.2V-A/f 4000 Ekip Touch LSI	1SDA079492R1						
E6.2V-A/f 4000 Ekip Touch LSIG	1SDA079493R1						
E6.2V-A/f 4000 Ekip Hi-Touch LSI	1SDA079495R1						
E6.2V-A/f 4000 Ekip Hi-Touch LSIG	1SDA079496R1						
5000	100	100	E6.2V-A/f 5000 Ekip Dip LI				
			E6.2V-A/f 5000 Ekip Dip LSI		1SDA079499R1		
			E6.2V-A/f 5000 Ekip Dip LSIG		1SDA079500R1		
			E6.2V-A/f 5000 Ekip Touch LI		1SDA079501R1		
			E6.2V-A/f 5000 Ekip Touch LSI		1SDA079502R1		
			E6.2V-A/f 5000 Ekip Touch LSIG		1SDA079503R1		
			E6.2V-A/f 5000 Ekip Hi-Touch LSI		1SDA079505R1		
			E6.2V-A/f 5000 Ekip Hi-Touch LSIG		1SDA079506R1		
			6000 (*)		100	100	E6.2V-A/f 6000 Ekip Dip LI
E6.2V-A/f 6000 Ekip Dip LSI	1SDA079509R1						
E6.2V-A/f 6000 Ekip Dip LSIG	1SDA079510R1						
E6.2V-A/f 6000 Ekip Touch LI	1SDA079511R1						
E6.2V-A/f 6000 Ekip Touch LSI	1SDA079512R1						
E6.2V-A/f 6000 Ekip Touch LSIG	1SDA079513R1						
E6.2V-A/f 6000 Ekip Hi-Touch LSI	1SDA079515R1						
E6.2V-A/f 6000 Ekip Hi-Touch LSIG	1SDA079516R1						

* Version not yet available. Contact ABB

Automatic circuit breakers

Drawout version for power distribution



SACE Emax 2 E6.2L-A/f/X-A/f • Mobile part of drawout circuit breaker (MP)

Size	Frame Amps	Int. Rating (kA@508V)	Withstand (kA)	Type	4 Poles		
					Global code		
E6.2L-A/f	4000	150	100	E6.2L-A/f 4000 Ekip Dip LI	1SDA079458R1		
				E6.2L-A/f 4000 Ekip Dip LSI	1SDA079459R1		
				E6.2L-A/f 4000 Ekip Dip LSIG	1SDA079460R1		
				E6.2L-A/f 4000 Ekip Touch LI	1SDA079461R1		
				E6.2L-A/f 4000 Ekip Touch LSI	1SDA079462R1		
				E6.2L-A/f 4000 Ekip Touch LSIG	1SDA079463R1		
				E6.2L-A/f 4000 Ekip Hi-Touch LSI	1SDA079465R1		
				E6.2L-A/f 4000 Ekip Hi-Touch LSIG	1SDA079466R1		
				5000	150	100	E6.2L-A/f 5000 Ekip Dip LI
	E6.2L-A/f 5000 Ekip Dip LSI	1SDA079469R1					
	E6.2L-A/f 5000 Ekip Dip LSIG	1SDA079470R1					
	E6.2L-A/f 5000 Ekip Touch LI	1SDA079471R1					
	E6.2L-A/f 5000 Ekip Touch LSI	1SDA079472R1					
	E6.2L-A/f 5000 Ekip Touch LSIG	1SDA079473R1					
	E6.2L-A/f 5000 Ekip Hi-Touch LSI	1SDA079475R1					
	E6.2L-A/f 5000 Ekip Hi-Touch LSIG	1SDA079476R1					
	6000 (*)	150	100				E6.2L-A/f 6000 Ekip Dip LI
				E6.2L-A/f 6000 Ekip Dip LSI	1SDA079479R1		
				E6.2L-A/f 6000 Ekip Dip LSIG	1SDA079480R1		
				E6.2L-A/f 6000 Ekip Touch LI	1SDA079481R1		
				E6.2L-A/f 6000 Ekip Touch LSI	1SDA079482R1		
				E6.2L-A/f 6000 Ekip Touch LSIG	1SDA079483R1		
				E6.2L-A/f 6000 Ekip Hi-Touch LSI	1SDA079485R1		
				E6.2L-A/f 6000 Ekip Hi-Touch LSIG	1SDA079486R1		
				E6.2X-A/f (*)	4000	200	100
	E6.2X-A/f 4000 Ekip Dip LSI	1SDA079519R1					
	E6.2X-A/f 4000 Ekip Dip LSIG	1SDA079520R1					
E6.2X-A/f 4000 Ekip Touch LI	1SDA079521R1						
E6.2X-A/f 4000 Ekip Touch LSI	1SDA079522R1						
E6.2X-A/f 4000 Ekip Touch LSIG	1SDA079523R1						
E6.2X-A/f 4000 Ekip Hi-Touch LSI	1SDA079525R1						
E6.2X-A/f 4000 Ekip Hi-Touch LSIG	1SDA079526R1						
5000	200	100	E6.2X-A/f 5000 Ekip Dip LI				
			E6.2X-A/f 5000 Ekip Dip LSI		1SDA079529R1		
			E6.2X-A/f 5000 Ekip Dip LSIG		1SDA079530R1		
			E6.2X-A/f 5000 Ekip Touch LI		1SDA079531R1		
			E6.2X-A/f 5000 Ekip Touch LSI		1SDA079532R1		
			E6.2X-A/f 5000 Ekip Touch LSIG		1SDA079533R1		
			E6.2X-A/f 5000 Ekip Hi-Touch LSI		1SDA079535R1		
			E6.2X-A/f 5000 Ekip Hi-Touch LSIG		1SDA079536R1		
			6000		200	100	E6.2X-A/f 6000 Ekip Dip LI
E6.2X-A/f 6000 Ekip Dip LSI	1SDA079539R1						
E6.2X-A/f 6000 Ekip Dip LSIG	1SDA079540R1						
E6.2X-A/f 6000 Ekip Touch LI	1SDA079541R1						
E6.2X-A/f 6000 Ekip Touch LSI	1SDA079542R1						
E6.2X-A/f 6000 Ekip Touch LSIG	1SDA079543R1						
E6.2X-A/f 6000 Ekip Hi-Touch LSI	1SDA079545R1						
E6.2X-A/f 6000 Ekip Hi-Touch LSIG	1SDA079546R1						

* Version not yet available. Contact ABB

Automatic circuit breakers

Fixed version for generators



SACE Emax E1.2B-N-S • Front terminals (F)

Size	Frame Amps	Int. Rating (kA@508V)	Withstand (kA)	Type	3 Poles		4 Poles	
					Global code		Global code	
E1.2B-A	800	42	42	E1.2B-A 800 Ekip G Touch LSIG	1SDA076914R1		1SDA076994R1	
				E1.2B-A 800 Ekip G Hi-Touch LSIG	1SDA076917R1		1SDA076997R1	
	1200	42	42	E1.2B-A 1200 Ekip G Touch LSIG	1SDA076924R1		1SDA077004R1	
				E1.2B-A 1200 Ekip G Hi-Touch LSIG	1SDA076927R1		1SDA077007R1	
E1.2N-A	800	50	50	E1.2N-A 800 Ekip G Touch LSIG	1SDA076934R1		1SDA077014R1	
				E1.2N-A 800 Ekip G Hi-Touch LSIG	1SDA076937R1		1SDA077017R1	
	1200	50	50	E1.2N-A 1200 Ekip G Touch LSIG	1SDA076944R1		1SDA077024R1	
				E1.2N-A 1200 Ekip G Hi-Touch LSIG	1SDA076947R1		1SDA077027R1	
E1.2S-A	250	65	50	E1.2S-A 250 Ekip G Touch LSIG	1SDA076954R1		1SDA077034R1	
				E1.2S-A 250 Ekip G Hi-Touch LSIG	1SDA076957R1		1SDA077037R1	
	400	65	50	E1.2S-A 400 Ekip G Touch LSIG	1SDA076964R1		1SDA077044R1	
				E1.2S-A 400 Ekip G Hi-Touch LSIG	1SDA076967R1		1SDA077047R1	
	800	65	50	E1.2S-A 800 Ekip G Touch LSIG	1SDA076974R1		1SDA077054R1	
				E1.2S-A 800 Ekip G Hi-Touch LSIG	1SDA076977R1		1SDA077057R1	
	1200	65	50	E1.2S-A 1200 Ekip G Touch LSIG	1SDA076984R1		1SDA077064R1	
				E1.2S-A 1200 Ekip G Hi-Touch LSIG	1SDA076987R1		1SDA077067R1	

Automatic circuit breakers

Fixed version for generators



SACE Emax 2 E2.2 B-A, N-A, S-A, H-A, V-A • Orientable rear terminals (HR)

Size	Frame Amps	Int. Rating (kA@508V)	Withstand (kA)	Type	3 Poles		4 Poles	
					Global code		Global code	
E2.2B-A	1600	42	42	E2.2B-A 1600 Ekip G Touch LSIG	1SDA077234R1		1SDA077404R1	
				E2.2B-A 1600 Ekip G Hi-Touch LSIG	1SDA077237R1		1SDA077407R1	
E2.2N-A	1600	50	50	E2.2N-A 1600 Ekip G Touch LSIG	1SDA077284R1		1SDA077454R1	
				E2.2N-A 1600 Ekip G Hi-Touch LSIG	1SDA077287R1		1SDA077457R1	
	2000	50	50	E2.2N-A 2000 Ekip G Touch LSIG	1SDA077294R1		1SDA077464R1	
				E2.2N-A 2000 Ekip G Hi-Touch LSIG	1SDA077297R1		1SDA077467R1	
E2.2S-A	800	65	65	E2.2S-A 800 Ekip G Touch LSIG	1SDA077304R1		1SDA077474R1	
				E2.2S-A 800 Ekip G Hi-Touch LSIG	1SDA077307R1		1SDA077477R1	
	1200	65	65	E2.2S-A 1200 Ekip G Touch LSIG	1SDA077314R1		1SDA077484R1	
				E2.2S-A 1200 Ekip G Hi-Touch LSIG	1SDA077317R1		1SDA077487R1	
	1600	65	65	E2.2S-A 1600 Ekip G Touch LSIG	1SDA077324R1		1SDA077494R1	
				E2.2S-A 1600 Ekip G Hi-Touch LSIG	1SDA077327R1		1SDA077497R1	
	2000	65	65	E2.2S-A 2000 Ekip G Touch LSIG	1SDA077334R1		1SDA077504R1	
				E2.2S-A 2000 Ekip G Hi-Touch LSIG	1SDA077337R1		1SDA077507R1	
E2.2H-A	800	85	85	E2.2H-A 800 Ekip G Touch LSIG	1SDA077244R1		1SDA077414R1	
				E2.2H-A 800 Ekip G Hi-Touch LSIG	1SDA077247R1		1SDA077417R1	
	1200	85	85	E2.2H-A 1200 Ekip G Touch LSIG	1SDA077254R1		1SDA077424R1	
				E2.2H-A 1200 Ekip G Hi-Touch LSIG	1SDA077257R1		1SDA077427R1	
	1600	85	85	E2.2H-A 1600 Ekip G Touch LSIG	1SDA077264R1		1SDA077434R1	
				E2.2H-A 1600 Ekip G Hi-Touch LSIG	1SDA077267R1		1SDA077437R1	
2000	85	85	E2.2H-A 2000 Ekip G Touch LSIG	1SDA077274R1		1SDA077444R1		
			E2.2H-A 2000 Ekip G Hi-Touch LSIG	1SDA077277R1		1SDA077447R1		
E2.2V-A	250	100	85	E2.2V-A 250 Ekip G Touch LSIG	1SDA077344R1		1SDA077514R1	
				E2.2V-A 250 Ekip G Hi-Touch LSIG	1SDA077347R1		1SDA077517R1	
	400	100	85	E2.2V-A 400 Ekip G Touch LSIG	1SDA077354R1		1SDA077524R1	
				E2.2V-A 400 Ekip G Hi-Touch LSIG	1SDA077357R1		1SDA077527R1	
	800	100	85	E2.2V-A 800 Ekip G Touch LSIG	1SDA077364R1		1SDA077534R1	
				E2.2V-A 800 Ekip G Hi-Touch LSIG	1SDA077367R1		1SDA077537R1	
	1200	100	85	E2.2V-A 1200 Ekip G Touch LSIG	1SDA077374R1		1SDA077544R1	
				E2.2V-A 1200 Ekip G Hi-Touch LSIG	1SDA077377R1		1SDA077547R1	
	1600	100	85	E2.2V-A 1600 Ekip G Touch LSIG	1SDA077384R1		1SDA077554R1	
				E2.2V-A 1600 Ekip G Hi-Touch LSIG	1SDA077387R1		1SDA077557R1	
	2000	100	85	E2.2V-A 2000 Ekip G Touch LSIG	1SDA077394R1		1SDA077564R1	
				E2.2V-A 2000 Ekip G Hi-Touch LSIG	1SDA077397R1		1SDA077567R1	



1SDC200039D0201_UL

SACE Emax 2 E4.2 S-A, H-A, V-A, L-A, X-A • Orientable rear terminals up to 2500A (HR)

Size	Frame Amps	Int. Rating (kA@508V)	Withstand (kA)	Type	3 Poles		4 Poles	
					Global code		Global code	
E4.2S-A	2500	65	65	E4.2S-A 2500 Ekip G Touch LSIG	1SDA078004R1		1SDA078234R1	
				E4.2S-A 2500 Ekip G Hi-Touch LSIG	1SDA078007R1		1SDA078237R1	
	3200 (*)	65	65	E4.2S-A 3200 Ekip G Touch LSIG	1SDA078014R1		1SDA078244R1	
				E4.2S-A 3200 Ekip G Hi-Touch LSIG	1SDA078017R1		1SDA078247R1	
E4.2H-A	2500	85	85	E4.2H-A 2500 Ekip G Touch LSIG	1SDA077914R1		1SDA078144R1	
				E4.2H-A 2500 Ekip G Hi-Touch LSIG	1SDA077917R1		1SDA078147R1	
	3200 (*)	85	85	E4.2H-A 3200 Ekip G Touch LSIG	1SDA077924R1		1SDA078154R1	
				E4.2H-A 3200 Ekip G Hi-Touch LSIG	1SDA077927R1		1SDA078157R1	
E4.2V-A	800	100	85	E4.2V-A 800 Ekip G Touch LSIG	1SDA078034R1		1SDA078264R1	
				E4.2V-A 800 Ekip G Hi-Touch LSIG	1SDA078037R1		1SDA078267R1	
	1600	100	85	E4.2V-A 1600 Ekip G Touch LSIG	1SDA078044R1		1SDA078274R1	
				E4.2V-A 1600 Ekip G Hi-Touch LSIG	1SDA078047R1		1SDA078277R1	
	2000	100	85	E4.2V-A 2000 Ekip G Touch LSIG	1SDA078054R1		1SDA078284R1	
				E4.2V-A 2000 Ekip G Hi-Touch LSIG	1SDA078057R1		1SDA078287R1	
	2500	100	85	E4.2V-A 2500 Ekip G Touch LSIG	1SDA078064R1		1SDA078294R1	
				E4.2V-A 2500 Ekip G Hi-Touch LSIG	1SDA078067R1		1SDA078297R1	
	3200 (*)	100	85	E4.2V-A 3200 Ekip G Touch LSIG	1SDA078074R1		1SDA078304R1	
				E4.2V-A 3200 Ekip G Hi-Touch LSIG	1SDA078077R1		1SDA078307R1	
E4.2L-A	800	125	100	E4.2L-A 800 Ekip G Touch LSIG	1SDA077944R1		1SDA078174R1	
				E4.2L-A 800 Ekip G Hi-Touch LSIG	1SDA077947R1		1SDA078177R1	
	1600	125	100	E4.2L-A 1600 Ekip G Touch LSIG	1SDA077954R1		1SDA078184R1	
				E4.2L-A 1600 Ekip G Hi-Touch LSIG	1SDA077957R1		1SDA078187R1	
	2000	125	100	E4.2L-A 2000 Ekip G Touch LSIG	1SDA077964R1		1SDA078194R1	
				E4.2L-A 2000 Ekip G Hi-Touch LSIG	1SDA077967R1		1SDA078197R1	
	2500	125	100	E4.2L-A 2500 Ekip G Touch LSIG	1SDA077974R1		1SDA078204R1	
				E4.2L-A 2500 Ekip G Hi-Touch LSIG	1SDA077977R1		1SDA078207R1	
	3200 (*)	125	100	E4.2L-A 3200 Ekip G Touch LSIG	1SDA077984R1		1SDA078214R1	
				E4.2L-A 3200 Ekip G Hi-Touch LSIG	1SDA077987R1		1SDA078217R1	
E4.2X-A (**)	1600	200	50	E4.2X-A 1600 Ekip G Touch LSIG	1SDA078094R1		1SDA078324R1	
				E4.2X-A 1600 Ekip G Hi-Touch LSIG	1SDA078097R1		1SDA078327R1	
	2000	200	50	E4.2X-A 2000 Ekip G Touch LSIG	1SDA078104R1		1SDA078334R1	
				E4.2X-A 2000 Ekip G Hi-Touch LSIG	1SDA078107R1		1SDA078337R1	
	2500	200	50	E4.2X-A 2500 Ekip G Touch LSIG	1SDA078114R1		1SDA078344R1	
				E4.2X-A 2500 Ekip G Hi-Touch LSIG	1SDA078117R1		1SDA078347R1	
	3200 (*)	200	50	E4.2X-A 3200 Ekip G Touch LSIG	1SDA078124R1		1SDA078354R1	
				E4.2X-A 3200 Ekip G Hi-Touch LSIG	1SDA078127R1		1SDA078357R1	

* 3200A ratings only with rear vertical terminals

** Version not yet available. Contact ABB

Automatic circuit breakers

Fixed version for generators



1SDC200664F001_L1L

SACE Emax 2 E6.2 H-A, V-A, L-A, X-A • Orientable rear terminals up to 5000A (HR)

Size	Frame Amps	Int. Rating (kA@508V)	Withstand (kA)	Type	3 Poles		4 Poles	
					Global code		Global code	
E6.2H-A	4000	85	85	E6.2H-A 4000 Ekip G Touch LSIG	1SDA078834R1		1SDA078954R1	
				E6.2H-A 4000 Ekip G Hi-Touch LSIG	1SDA078837R1		1SDA078957R1	
	5000	85	85	E6.2H-A 5000 Ekip G Touch LSIG	1SDA078844R1		1SDA078964R1	
				E6.2H-A 5000 Ekip G Hi-Touch LSIG	1SDA078847R1		1SDA078967R1	
	6000 (*)	85	85	E6.2H-A 6000 Ekip G Touch LSIG	1SDA078854R1		1SDA078974R1	
				E6.2H-A 6000 Ekip G Hi-Touch LSIG	1SDA078857R1		1SDA078977R1	
E6.2V-A	4000	100	100	E6.2V-A 4000 Ekip G Touch LSIG	1SDA078894R1		1SDA079014R1	
				E6.2V-A 4000 Ekip G Hi-Touch LSIG	1SDA078897R1		1SDA079017R1	
	5000	100	100	E6.2V-A 5000 Ekip G Touch LSIG	1SDA078904R1		1SDA079024R1	
				E6.2V-A 5000 Ekip G Hi-Touch LSIG	1SDA078907R1		1SDA079027R1	
	6000 (*)	100	100	E6.2V-A 6000 Ekip G Touch LSIG	1SDA078914R1		1SDA079034R1	
				E6.2V-A 6000 Ekip G Hi-Touch LSIG	1SDA078917R1		1SDA079037R1	
E6.2L-A	4000	150	100	E6.2L-A 4000 Ekip G Touch LSIG	1SDA078864R1		1SDA078984R1	
				E6.2L-A 4000 Ekip G Hi-Touch LSIG	1SDA078867R1		1SDA078987R1	
	5000	150	100	E6.2L-A 5000 Ekip G Touch LSIG	1SDA078874R1		1SDA078994R1	
				E6.2L-A 5000 Ekip G Hi-Touch LSIG	1SDA078877R1		1SDA078997R1	
	6000 (*)	150	100	E6.2L-A 6000 Ekip G Touch LSIG	1SDA078884R1		1SDA079004R1	
				E6.2L-A 6000 Ekip G Hi-Touch LSIG	1SDA078887R1		1SDA079007R1	
E6.2X-A (**)	4000	200	100	E6.2X-A 4000 Ekip G Touch LSIG	1SDA078924R1		1SDA079044R1	
				E6.2X-A 4000 Ekip G Hi-Touch LSIG	1SDA078927R1		1SDA079047R1	
	5000	200	100	E6.2X-A 5000 Ekip G Touch LSIG	1SDA078934R1		1SDA079054R1	
				E6.2X-A 5000 Ekip G Hi-Touch LSIG	1SDA078937R1		1SDA079057R1	
	6000 (*)	200	100	E6.2X-A 6000 Ekip G Touch LSIG	1SDA078944R1		1SDA079064R1	
				E6.2X-A 6000 Ekip G Hi-Touch LSIG	1SDA078947R1		1SDA079067R1	

* 6000A ratings only with rear vertical terminals. Version not yet available. Contact ABB

** Version not yet available. Contact ABB



1SDC200684F001_LUL

SACE Emax 2 E6.2 H-A/f, V-A/f, L-A/f, X-A/f full size • Orientable rear terminals up to 5000A (HR)

Size	Frame Amps	Int. Rating (kA@508V)	Withstand (kA)	Type	4 Poles	
					Global code	
E6.2H-A/f	4000	85	85	E6.2H-A/f 4000 Ekip G Touch LSIG	1SDA079314R1	
				E6.2H-A/f 4000 Ekip G Hi-Touch LSIG	1SDA079317R1	
	5000	85	85	E6.2H-A/f 5000 Ekip G Touch LSIG	1SDA079324R1	
				E6.2H-A/f 5000 Ekip G Hi-Touch LSIG	1SDA079327R1	
	6000 (*)	85	85	E6.2H-A/f 6000 Ekip G Touch LSIG	1SDA079334R1	
				E6.2H-A/f 6000 Ekip G Hi-Touch LSIG	1SDA079337R1	
E6.2V-A/f	4000	100	100	E6.2V-A/f 4000 Ekip G Touch LSIG	1SDA079374R1	
				E6.2V-A/f 4000 Ekip G Hi-Touch LSIG	1SDA079377R1	
	5000	100	100	E6.2V-A/f 5000 Ekip G Touch LSIG	1SDA079384R1	
				E6.2V-A/f 5000 Ekip G Hi-Touch LSIG	1SDA079387R1	
	6000 (*)	100	100	E6.2V-A/f 6000 Ekip G Touch LSIG	1SDA079394R1	
				E6.2V-A/f 6000 Ekip G Hi-Touch LSIG	1SDA079397R1	
E6.2L-A/f	4000	150	100	E6.2L-A/f 4000 Ekip G Touch LSIG	1SDA079344R1	
				E6.2L-A/f 4000 Ekip G Hi-Touch LSIG	1SDA079347R1	
	5000	150	100	E6.2L-A/f 5000 Ekip G Touch LSIG	1SDA079354R1	
				E6.2L-A/f 5000 Ekip G Hi-Touch LSIG	1SDA079357R1	
	6000 (*)	150	100	E6.2L-A/f 6000 Ekip G Touch LSIG	1SDA079364R1	
				E6.2L-A/f 6000 Ekip G Hi-Touch LSIG	1SDA079367R1	
E6.2X-A/f (**)	4000	200	100	E6.2X-A/f 4000 Ekip G Touch LSIG	1SDA079404R1	
				E6.2X-A/f 4000 Ekip G Hi-Touch LSIG	1SDA079407R1	
	5000	200	100	E6.2X-A/f 5000 Ekip G Touch LSIG	1SDA079414R1	
				E6.2X-A/f 5000 Ekip G Hi-Touch LSIG	1SDA079417R1	
	6000 (*)	200	100	E6.2X-A/f 6000 Ekip G Touch LSIG	1SDA079424R1	
				E6.2X-A/f 6000 Ekip G Hi-Touch LSIG	1SDA079427R1	

* 6000A ratings only with rear vertical terminals. Version not yet available. Contact ABB

** Version not yet available. Contact ABB

Automatic circuit breakers

Drawout version for generators



SACE Emax 2 E1.2 B-A, N-A, S-A • Mobile part of drawout circuit breaker (MP)

Size	Frame Amps	Int. Rating (kA@508V)	Withstand (kA)	Type	3 Poles		4 Poles		
					Global code		Global code		
E1.2B-A	800	42	42	E1.2B-A 800 Ekip G Touch LSIG	1SDA077074R1		1SDA077154R1		
				E1.2B-A 800 Ekip G Hi-Touch LSIG	1SDA077077R1		1SDA077157R1		
	1200	42	42	E1.2B-A 1200 Ekip G Touch LSIG	1SDA077084R1		1SDA077164R1		
				E1.2B-A 1200 Ekip G Hi-Touch LSIG	1SDA077087R1		1SDA077167R1		
E1.2N-A	800	50	50	E1.2N-A 800 Ekip G Touch LSIG	1SDA077094R1		1SDA077174R1		
				E1.2N-A 800 Ekip G Hi-Touch LSIG	1SDA077097R1		1SDA077177R1		
	1200	50	50	E1.2N-A 1200 Ekip G Touch LSIG	1SDA077104R1		1SDA077184R1		
				E1.2N-A 1200 Ekip G Hi-Touch LSIG	1SDA077107R1		1SDA077187R1		
	E1.2S-A	250	65	50	E1.2S-A 250 Ekip G Touch LSIG	1SDA077114R1		1SDA077194R1	
					E1.2S-A 250 Ekip G Hi-Touch LSIG	1SDA077117R1		1SDA077197R1	
400		65	50	E1.2S-A 400 Ekip G Touch LSIG	1SDA077124R1		1SDA077204R1		
				E1.2S-A 400 Ekip G Hi-Touch LSIG	1SDA077127R1		1SDA077207R1		
800		65	50	E1.2S-A 800 Ekip G Touch LSIG	1SDA077134R1		1SDA077214R1		
				E1.2S-A 800 Ekip G Hi-Touch LSIG	1SDA077137R1		1SDA077217R1		
1200	65	50	E1.2S-A 1200 Ekip G Touch LSIG	1SDA077144R1		1SDA077224R1			
			E1.2S-A 1200 Ekip G Hi-Touch LSIG	1SDA077147R1		1SDA077227R1			



1SDC200066F001_LL

SACE Emax 2 E2.2 B-A, N-A, S-A, H-A, V-A • Mobile part of drawout circuit breaker (MP)

Size	Frame Amps	Int. Rating (kA@508V)	Withstand (kA)	Type	3 Poles		4 Poles	
					Global code		Global code	
E2.2B-A	1600	42	42	E2.2B-A 1600 Ekip G Touch LSIG	1SDA077574R1		1SDA077744R1	
				E2.2B-A 1600 Ekip G Hi-Touch LSIG	1SDA077577R1		1SDA077747R1	
E2.2N-A	1600	50	50	E2.2N-A 1600 Ekip G Touch LSIG	1SDA077624R1		1SDA077794R1	
				E2.2N-A 1600 Ekip G Hi-Touch LSIG	1SDA077627R1		1SDA077797R1	
	2000	50	50	E2.2N-A 2000 Ekip G Touch LSIG	1SDA077634R1		1SDA077804R1	
				E2.2N-A 2000 Ekip G Hi-Touch LSIG	1SDA077637R1		1SDA077807R1	
E2.2S-A	800	65	65	E2.2S-A 800 Ekip G Touch LSIG	1SDA077644R1		1SDA077814R1	
				E2.2S-A 800 Ekip G Hi-Touch LSIG	1SDA077647R1		1SDA077817R1	
	1200	65	65	E2.2S-A 1200 Ekip G Touch LSIG	1SDA077654R1		1SDA077824R1	
				E2.2S-A 1200 Ekip G Hi-Touch LSIG	1SDA077657R1		1SDA077827R1	
	1600	65	65	E2.2S-A 1600 Ekip G Touch LSIG	1SDA077664R1		1SDA077834R1	
				E2.2S-A 1600 Ekip G Hi-Touch LSIG	1SDA077667R1		1SDA077837R1	
	2000	65	65	E2.2S-A 2000 Ekip G Touch LSIG	1SDA077674R1		1SDA077844R1	
				E2.2S-A 2000 Ekip G Hi-Touch LSIG	1SDA077677R1		1SDA077847R1	
E2.2H-A	800	85	85	E2.2H-A 800 Ekip G Touch LSIG	1SDA077584R1		1SDA077754R1	
				E2.2H-A 800 Ekip G Hi-Touch LSIG	1SDA077587R1		1SDA077757R1	
	1200	85	85	E2.2H-A 1200 Ekip G Touch LSIG	1SDA077594R1		1SDA077764R1	
				E2.2H-A 1200 Ekip G Hi-Touch LSIG	1SDA077597R1		1SDA077767R1	
	1600	85	85	E2.2H-A 1600 Ekip G Touch LSIG	1SDA077604R1		1SDA077774R1	
				E2.2H-A 1600 Ekip G Hi-Touch LSIG	1SDA077607R1		1SDA077777R1	
	2000	85	85	E2.2H-A 2000 Ekip G Touch LSIG	1SDA077614R1		1SDA077784R1	
				E2.2H-A 2000 Ekip G Hi-Touch LSIG	1SDA077617R1		1SDA077787R1	
E2.2V-A	250	100	85	E2.2V-A 250 Ekip G Touch LSIG	1SDA077684R1		1SDA077854R1	
				E2.2V-A 250 Ekip G Hi-Touch LSIG	1SDA077687R1		1SDA077857R1	
	400	100	85	E2.2V-A 400 Ekip G Touch LSIG	1SDA077694R1		1SDA077864R1	
				E2.2V-A 400 Ekip G Hi-Touch LSIG	1SDA077697R1		1SDA077867R1	
	800	100	85	E2.2V-A 800 Ekip G Touch LSIG	1SDA077704R1		1SDA077874R1	
				E2.2V-A 800 Ekip G Hi-Touch LSIG	1SDA077707R1		1SDA077877R1	
	1200	100	85	E2.2V-A 1200 Ekip G Touch LSIG	1SDA077714R1		1SDA077884R1	
				E2.2V-A 1200 Ekip G Hi-Touch LSIG	1SDA077717R1		1SDA077887R1	
	1600	100	85	E2.2V-A 1600 Ekip G Touch LSIG	1SDA077724R1		1SDA077894R1	
				E2.2V-A 1600 Ekip G Hi-Touch LSIG	1SDA077727R1		1SDA077897R1	
	2000	100	85	E2.2V-A 2000 Ekip G Touch LSIG	1SDA077734R1		1SDA077904R1	
				E2.2V-A 2000 Ekip G Hi-Touch LSIG	1SDA077737R1		1SDA077907R1	

Automatic circuit breakers

Drawout version for generators



SACE Emax 2 E4.2 S-A, H-A, V-A, L-A, X-A • Mobile part of drawout circuit breaker (MP)

Size	Frame Amps	Int. Rating (kA@508V)	Withstand (kA)	Type	3 Poles		4 Poles	
					Global code		Global code	
E4.2S-A	2500	65	65	E4.2S-A 2500 Ekip G Touch LSIG	1SDA078464R1		1SDA078694R1	
				E4.2S-A 2500 Ekip G Hi-Touch LSIG	1SDA078467R1		1SDA078697R1	
	3200	65	65	E4.2S-A 3200 Ekip G Touch LSIG	1SDA078474R1		1SDA078704R1	
				E4.2S-A 3200 Ekip G Hi-Touch LSIG	1SDA078477R1		1SDA078707R1	
E4.2H-A	2500	85	85	E4.2H-A 2500 Ekip G Touch LSIG	1SDA078374R1		1SDA078604R1	
				E4.2H-A 2500 Ekip G Hi-Touch LSIG	1SDA078377R1		1SDA078607R1	
	3200	85	85	E4.2H-A 3200 Ekip G Touch LSIG	1SDA078384R1		1SDA078614R1	
				E4.2H-A 3200 Ekip G Hi-Touch LSIG	1SDA078387R1		1SDA078617R1	
E4.2V-A	800	100	85	E4.2V-A 800 Ekip G Touch LSIG	1SDA078494R1		1SDA078724R1	
				E4.2V-A 800 Ekip G Hi-Touch LSIG	1SDA078497R1		1SDA078727R1	
	1600	100	85	E4.2V-A 1600 Ekip G Touch LSIG	1SDA078504R1		1SDA078734R1	
				E4.2V-A 1600 Ekip G Hi-Touch LSIG	1SDA078507R1		1SDA078737R1	
	2000	100	85	E4.2V-A 2000 Ekip G Touch LSIG	1SDA078514R1		1SDA078744R1	
				E4.2V-A 2000 Ekip G Hi-Touch LSIG	1SDA078517R1		1SDA078747R1	
	2500	100	85	E4.2V-A 2500 Ekip G Touch LSIG	1SDA078524R1		1SDA078754R1	
				E4.2V-A 2500 Ekip G Hi-Touch LSIG	1SDA078527R1		1SDA078757R1	
	3200	100	85	E4.2V-A 3200 Ekip G Touch LSIG	1SDA078534R1		1SDA078764R1	
				E4.2V-A 3200 Ekip G Hi-Touch LSIG	1SDA078537R1		1SDA078767R1	
E4.2L-A	800	125	100	E4.2L-A 800 Ekip G Touch LSIG	1SDA078404R1		1SDA078634R1	
				E4.2L-A 800 Ekip G Hi-Touch LSIG	1SDA078407R1		1SDA078637R1	
	1600	125	100	E4.2L-A 1600 Ekip G Touch LSIG	1SDA078414R1		1SDA078644R1	
				E4.2L-A 1600 Ekip G Hi-Touch LSIG	1SDA078417R1		1SDA078647R1	
	2000	125	100	E4.2L-A 2000 Ekip G Touch LSIG	1SDA078424R1		1SDA078654R1	
				E4.2L-A 2000 Ekip G Hi-Touch LSIG	1SDA078427R1		1SDA078657R1	
	2500	125	100	E4.2L-A 2500 Ekip G Touch LSIG	1SDA078434R1		1SDA078664R1	
				E4.2L-A 2500 Ekip G Hi-Touch LSIG	1SDA078437R1		1SDA078667R1	
3200	125	100	E4.2L-A 3200 Ekip G Touch LSIG	1SDA078444R1		1SDA078674R1		
			E4.2L-A 3200 Ekip G Hi-Touch LSIG	1SDA078447R1		1SDA078677R1		
E4.2X-A (*)	1600	200	50	E4.2X-A 1600 Ekip G Touch LSIG	1SDA078554R1		1SDA078784R1	
				E4.2X-A 1600 Ekip G Hi-Touch LSIG	1SDA078557R1		1SDA078787R1	
	2000	200	50	E4.2X-A 2000 Ekip G Touch LSIG	1SDA078564R1		1SDA078794R1	
				E4.2X-A 2000 Ekip G Hi-Touch LSIG	1SDA078567R1		1SDA078797R1	
	2500	200	50	E4.2X-A 2500 Ekip G Touch LSIG	1SDA078574R1		1SDA078804R1	
				E4.2X-A 2500 Ekip G Hi-Touch LSIG	1SDA078577R1		1SDA078807R1	
	3200	200	50	E4.2X-A 3200 Ekip G Touch LSIG	1SDA078584R1		1SDA078814R1	
				E4.2X-A 3200 Ekip G Hi-Touch LSIG	1SDA078587R1		1SDA078817R1	

* Version not yet available. Contact ABB



1SDC200688F001_UL

SACE Emax 2 E6.2 H-A, V-A, L-A, X-A - Mobile part of drawout circuit breaker (MP)

Size	Frame Amps	Int. Rating (kA@508V)	Withstand (kA)	Type	3 Poles		4 Poles	
					Global code		Global code	
E6.2H-A	4000	85	85	E6.2H-A 4000 Ekip G Touch LSIG	1SDA079074R1		1SDA079194R1	
				E6.2H-A 4000 Ekip G Hi-Touch LSIG	1SDA079077R1		1SDA079197R1	
	5000	85	85	E6.2H-A 5000 Ekip G Touch LSIG	1SDA079084R1		1SDA079204R1	
				E6.2H-A 5000 Ekip G Hi-Touch LSIG	1SDA079087R1		1SDA079207R1	
	6000 (*)	85	85	E6.2H-A 6000 Ekip G Touch LSIG	1SDA079094R1		1SDA079214R1	
				E6.2H-A 6000 Ekip G Hi-Touch LSIG	1SDA079097R1		1SDA079217R1	
E6.2V-A	4000	100	100	E6.2V-A 4000 Ekip G Touch LSIG	1SDA079134R1		1SDA079254R1	
				E6.2V-A 4000 Ekip G Hi-Touch LSIG	1SDA079137R1		1SDA079257R1	
	5000	100	100	E6.2V-A 5000 Ekip G Touch LSIG	1SDA079144R1		1SDA079264R1	
				E6.2V-A 5000 Ekip G Hi-Touch LSIG	1SDA079147R1		1SDA079265R1	
	6000 (*)	100	100	E6.2V-A 6000 Ekip G Touch LSIG	1SDA079154R1		1SDA079274R1	
				E6.2V-A 6000 Ekip G Hi-Touch LSIG	1SDA079157R1		1SDA079277R1	
E6.2L-A	4000	150	100	E6.2L-A 4000 Ekip G Touch LSIG	1SDA079104R1		1SDA079224R1	
				E6.2L-A 4000 Ekip G Hi-Touch LSIG	1SDA079107R1		1SDA079227R1	
	5000	150	100	E6.2L-A 5000 Ekip G Touch LSIG	1SDA079114R1		1SDA079234R1	
				E6.2L-A 5000 Ekip G Hi-Touch LSIG	1SDA079117R1		1SDA079237R1	
	6000 (*)	150	100	E6.2L-A 6000 Ekip G Touch LSIG	1SDA079124R1		1SDA079244R1	
				E6.2L-A 6000 Ekip G Hi-Touch LSIG	1SDA079127R1		1SDA079247R1	
E6.2X-A (*)	4000	200	100	E6.2X-A 4000 Ekip G Touch LSIG	1SDA079164R1		1SDA079284R1	
				E6.2X-A 4000 Ekip G Hi-Touch LSIG	1SDA079167R1		1SDA079287R1	
	5000	200	100	E6.2X-A 5000 Ekip G Touch LSIG	1SDA079174R1		1SDA079294R1	
				E6.2X-A 5000 Ekip G Hi-Touch LSIG	1SDA079177R1		1SDA079297R1	
	6000	200	100	E6.2X-A 6000 Ekip G Touch LSIG	1SDA079184R1		1SDA079304R1	
				E6.2X-A 6000 Ekip G Hi-Touch LSIG	1SDA079187R1		1SDA079307R1	

* Version not yet available. Contact ABB

Automatic circuit breakers

Drawout version per generators



1SDC20000001_LUL

SACE Emax 2 E6.2 H-A/f, V-A/f, L-A/f, X-A/f full size - Mobile part of drawout circuit breaker (MP)

Size	Frame Amps	Int. Rating (kA@508V)	Withstand (kA)	Type	4 Poles	
					Global code	
E6.2H-A/f	4000	85	85	E6.2H-A/f 4000 Ekip G Touch LSIG	1SDA079434R1	
				E6.2H-A/f 4000 Ekip G Hi-Touch LSIG	1SDA079437R1	
	5000	85	85	E6.2H-A/f 5000 Ekip G Touch LSIG	1SDA079444R1	
				E6.2H-A/f 5000 Ekip G Hi-Touch LSIG	1SDA079447R1	
	6000 (*)	85	85	E6.2H-A/f 6000 Ekip G Touch LSIG	1SDA079454R1	
				E6.2H-A/f 6000 Ekip G Hi-Touch LSIG	1SDA079457R1	
E6.2V-A/f	4000	100	100	E6.2V-A/f 4000 Ekip G Touch LSIG	1SDA079494R1	
				E6.2V-A/f 4000 Ekip G Hi-Touch LSIG	1SDA079497R1	
	5000	100	100	E6.2V-A/f 5000 Ekip G Touch LSIG	1SDA079504R1	
				E6.2V-A/f 5000 Ekip G Hi-Touch LSIG	1SDA079507R1	
	6000 (*)	100	100	E6.2V-A/f 6000 Ekip G Touch LSIG	1SDA079514R1	
				E6.2V-A/f 6000 Ekip G Hi-Touch LSIG	1SDA079517R1	
E6.2L-A/f	4000	150	100	E6.2L-A/f 4000 Ekip G Touch LSIG	1SDA079464R1	
				E6.2L-A/f 4000 Ekip G Hi-Touch LSIG	1SDA079467R1	
	5000	150	100	E6.2L-A/f 5000 Ekip G Touch LSIG	1SDA079474R1	
				E6.2L-A/f 5000 Ekip G Hi-Touch LSIG	1SDA079477R1	
	6000 (*)	150	100	E6.2L-A/f 6000 Ekip G Touch LSIG	1SDA079484R1	
				E6.2L-A/f 6000 Ekip G Hi-Touch LSIG	1SDA079487R1	
E6.2X-A/f (*)	4000	200	100	E6.2X-A/f 4000 Ekip G Touch LSIG	1SDA079524R1	
				E6.2X-A/f 4000 Ekip G Hi-Touch LSIG	1SDA079527R1	
	5000	200	100	E6.2X-A/f 5000 Ekip G Touch LSIG	1SDA079534R1	
				E6.2X-A/f 5000 Ekip G Hi-Touch LSIG	1SDA079537R1	
	6000	200	100	E6.2X-A/f 6000 Ekip G Touch LSIG	1SDA079544R1	
				E6.2X-A/f 6000 Ekip G Hi-Touch LSIG	1SDA079547R1	

* Version not yet available. Contact ABB

Switch disconnectors

Fixed version



1SDC200665F001_LU

SACE Emax 2 E1.2 B-A/MS, N-A/MS • Front terminals (F)

Size	Frame Amps	Withstand (kA)	Type	3 Poles		4 Poles	
				Global code		Global code	
E1.2B-A/MS	800	42	E1.2B-A/MS 800	1SDA079548R1		1SDA079552R1	
	1200	42	E1.2B-A/MS 1200	1SDA079549R1		1SDA079553R1	
E1.2N-A/MS	800	50	E1.2N-A/MS 800	1SDA079550R1		1SDA079554R1	
	1200	50	E1.2N-A/MS 1200	1SDA079551R1		1SDA079555R1	



1SDC200670F001_LU

SACE Emax 2 E2.2 N-A/MS, S-A/MS, V-A/MS • Orientable rear terminals (HR)

Size	Frame Amps	Withstand (kA)	Type	3 Poles		4 Poles	
				Global code		Global code	
E2.2N-A/MS	1600	50	E2.2N-A/MS 1600	1SDA079570R1		1SDA079578R1	
	2000	50	E2.2N-A/MS 2000	1SDA079571R1		1SDA079579R1	
E2.2S-A/MS	800	65	E2.2S-A/MS 800	1SDA079564R1		1SDA079572R1	
	1600	65	E2.2S-A/MS 1600	1SDA079565R1		1SDA079573R1	
	2000	65	E2.2S-A/MS 2000	1SDA079566R1		1SDA079574R1	
E2.2V-A/MS	800	85	E2.2V-A/MS 800	1SDA079567R1		1SDA079575R1	
	1600	85	E2.2V-A/MS 1600	1SDA079568R1		1SDA079576R1	
	2000	85	E2.2V-A/MS 2000	1SDA079569R1		1SDA079577R1	



1SDC200671F001_LU

SACE Emax 2 E4.2 S-A/MS, V-A/MS, L-A/MS • Orientable rear terminals up to 2500A (HR)

Size	Frame Amps	Withstand (kA)	Type	3 Poles		4 Poles	
				Global code		Global code	
E4.2S-A/MS	2500	65	E4.2S-A/MS 2500	1SDA079596R1		1SDA079612R1	
	3200 (*)	65	E4.2S-A/MS 3200	1SDA079597R1		1SDA079613R1	
E4.2V-A/MS	2500	85	E4.2V-A/MS 2500	1SDA079602R1		1SDA079618R1	
	3200 (*)	85	E4.2V-A/MS 3200	1SDA079603R1		1SDA079619R1	
E4.2L-A/MS	800	85	E4.2V-A/MS 800	1SDA079599R1		1SDA079615R1	
	1600	85	E4.2V-A/MS 1600	1SDA079600R1		1SDA079616R1	
	2000	85	E4.2V-A/MS 2000	1SDA079601R1		1SDA079617R1	
	2500	100	E4.2L-A/MS 2500	1SDA079605R1		1SDA079621R1	
	3200 (*)	100	E4.2L-A/MS 3200	1SDA079606R1		1SDA079622R1	

* 3200A ratings only with rear vertical terminals

Switch disconnectors

Fixed version



1SDC200072F001_LUL

SACE Emax 2 E6.2 L-A/MS • Orientable rear terminals up to 5000A (HR)

Size	Frame Amps	Withstand (kA)	Type	3 Poles		4 Poles	
				Global code		Global code	
E6.2L-A/MS	4000	100	E6.2L-A/MS 4000	1SDA079660R1		1SDA079666R1	
	5000	100	E6.2L-A/MS 5000	1SDA079661R1		1SDA079667R1	
	6000 (*)	100	E6.2L-A/MS 6000	1SDA079662R1		1SDA079668R1	

* 6000A ratings only with rear vertical terminals. Version not yet available. Contact ABB

SACE Emax 2 E6.2 L-A/f/MS • Orientable rear terminals up to 5000A (HR)

Size	Frame Amps	Withstand (kA)	Type	4 Poles	
				Global code	
E6.2H/MS	4000	100	E6.2H/MS 4000	1SDA073463R1	
	5000	100	E6.2H/MS 5000	1SDA073465R1	
	6000 (*)	100	E6.2H/MS 6300	1SDA073467R1	

* 6300A ratings only with rear vertical terminals. Version not yet available. Contact ABB

Switch disconnectors

Drawout version



1SDC200674F001_UL

SACE Emax 2 E1.2 B-A/MS, N-A/MS • Mobile part of switch disconnector (MP)

Size	Frame Amps	Withstand (kA)	Type	3 Poles		4 Poles	
				Global code		Global code	
E1.2B-A/MS	800	42	E1.2B-A/MS 800	1SDA079556R1		1SDA079560R1	
	1200	42	E1.2B-A/MS 1200	1SDA079557R1		1SDA079561R1	
E1.2N-A/MS	800	50	E1.2N-A/MS 800	1SDA079558R1		1SDA079562R1	
	1200	50	E1.2N-A/MS 1200	1SDA079559R1		1SDA079563R1	



1SDC200674F001_UL

SACE Emax 2 E2.2 N-A/MS, S-A/MS, V-A/MS • Mobile part of switch disconnector (MP)

Size	Frame Amps	Withstand (kA)	Type	3 Poles		4 Poles	
				Global code		Global code	
E2.2N-A/MS	1600	50	E2.2N-A/MS 1600	1SDA079586R1		1SDA079594R1	
	2000	50	E2.2N-A/MS 2000	1SDA079587R1		1SDA079595R1	
E2.2S-A/MS	800	65	E2.2S-A/MS 800	1SDA079580R1		1SDA079588R1	
	1600	65	E2.2S-A/MS 1600	1SDA079581R1		1SDA079589R1	
	2000	65	E2.2S-A/MS 2000	1SDA079582R1		1SDA079590R1	
E2.2V-A/MS	800	85	E2.2V-A/MS 800	1SDA079583R1		1SDA079591R1	
	1600	85	E2.2V-A/MS 1600	1SDA079584R1		1SDA079592R1	
	2000	85	E2.2V-A/MS 2000	1SDA079585R1		1SDA079593R1	



1SDC200674F001_UL

SACE Emax 2 E4.2 S-A/MS, V-A/MS, L-A/MS • Mobile part of switch disconnector (MP)

Size	Frame Amps	Withstand (kA)	Type	3 Poles		4 Poles	
				Global code		Global code	
E4.2S-A/MS	2500	65	E4.2S-A/MS 2500	1SDA079628R1		1SDA079644R1	
	3200	65	E4.2S-A/MS 3200	1SDA079629R1		1SDA079645R1	
E4.2V-A/MS	2500	85	E4.2V-A/MS 2500	1SDA079634R1		1SDA079650R1	
	3200	85	E4.2V-A/MS 3200	1SDA079635R1		1SDA079651R1	
E4.2L-A/MS	800	85	E4.2V-A/MS 800	1SDA079631R1		1SDA079647R1	
	1600	85	E4.2V-A/MS 1600	1SDA079632R1		1SDA079648R1	
	2000	85	E4.2V-A/MS 2000	1SDA079633R1		1SDA079649R1	
	2500	100	E4.2L-A/MS 2500	1SDA079637R1		1SDA079653R1	
	3200	100	E4.2L-A/MS 3200	1SDA079638R1		1SDA079654R1	

Switch disconnectors

Drawout version



SACE Emax 2 E6.2 L-A/MS • Mobile part of switch disconnector (MP)

Size	Frame Amps	Withstand (kA)	Type	3 Poles		4 Poles	
				Global code		Global code	
E6.2L-A/MS	4000	100	E6.2L-A/MS 4000	1SDA079672R1		1SDA079678R1	
	5000	100	E6.2L-A/MS 5000	1SDA079673R1		1SDA079679R1	
	6000 (*)	100	E6.2L-A/MS 6000	1SDA079674R1		1SDA079680R1	

* Version not yet available. Contact ABB

SACE Emax 2 E6.2 L-A/f/MS • Mobile part of switch disconnector (MP)

Size	Frame Amps	Withstand (kA)	Type	4 Poles	
				Global code	
E6.2L-A/f/MS	4000	100	E6.2L-A/f/MS 4000	1SDA079690R1	
	5000	100	E6.2L-A/f/MS 5000	1SDA079691R1	
	6000 (*)	100	E6.2L-A/f/MS 6000	1SDA079692R1	

* Version not yet available. Contact ABB

Cradles



Size	Performance	Amperage range	Terminal type	Type	3 Poles	4 Poles
					Global code	Global code
E1.2	B-A, N-A, S-A	250 - 1200	HR - HR	E1.2-A W FP Iu=1200 HR HR UL	1SDA079696R1	1SDA079697R1
E2.2	B-A, N-A, S-A, H-A, V-A	250 - 2000	HR - HR	E2.2-A W FP Iu=2000 HR HR UL	1SDA079698R1	1SDA079699R1
E4.2	S-A, H-A, V-A, L-A	800 - 2500	HR - HR	E4.2-A W FP Iu=2500 HR HR UL	1SDA079700R1	1SDA079701R1
	S-A, H-A, V-A, L-A	3200	VR-VR	E4.2-A W FP Iu=3200 VR VR UL	1SDA079702R1	1SDA079703R1
E6.2	H-A, V-A, L-A	4000 - 5000	HR - HR	E6.2-A W FP Iu=5000 HR HR UL	1SDA079706R1	1SDA079707R1
	H-A, V-A, L-A	6000 (*)	VR - VR	E6.2-A W FP Iu=6000 3p VR VR UL	1SDA079709R1	1SDA079710R1
E6.2/f	H-A, V-A, L-A	4000 - 5000	HR - HR	E6.2-A W FP Iu=5000 HR HR UL	-	1SDA079708R1
	H-A, V-A, L-A	6000 (*)	VR - VR	E6.2-A W FP Iu=6000 VR VR UL	-	1SDA079711R1

* Version not yet available. Contact ABB

Accessories

Electrical accessories



First and second shunt trip - YO

Size	Type	Global code
E1.2..E6.2	YO E1.2..E6.2 24 VAC/DC	1SDA073668R1
E1.2..E6.2	YO E1.2..E6.2 30 VAC/DC	1SDA073669R1
E1.2..E6.2	YO E1.2..E6.2 48 VAC/DC	1SDA073670R1
E1.2..E6.2	YO E1.2..E6.2 60 VAC/DC	1SDA073671R1
E1.2..E6.2	YO E1.2..E6.2 110-120 VAC/DC	1SDA073672R1
E1.2..E6.2	YO E1.2..E6.2 120-127 VAC/DC	1SDA073673R1
E1.2..E6.2	YO E1.2..E6.2 220-240 VAC/DC	1SDA073674R1
E1.2..E6.2	YO E1.2..E6.2 240-250 VAC/DC	1SDA073675R1
E1.2..E6.2	YO E1.2..E6.2 277 VAC	1SDA073676R1
E1.2..E6.2	YO E1.2..E6.2 380-400 VAC	1SDA073677R1
E1.2..E6.2	YO E1.2..E6.2 415-440 VAC	1SDA073678R1
E1.2..E6.2	YO E1.2..E6.2 480-500 VAC	1SDA073679R1

Second shunt trips are an alternative to a UVR or anti-racking out device (fail safe)

First and second closing coil - YC

Size	Type	Global code
E1.2..E6.2	YC E1.2..E6.2 24 VAC/DC	1SDA073681R1
E1.2..E6.2	YC E1.2..E6.2 30 VAC/DC	1SDA073682R1
E1.2..E6.2	YC E1.2..E6.2 48 VAC/DC	1SDA073683R1
E1.2..E6.2	YC E1.2..E6.2 60 VAC/DC	1SDA073684R1
E1.2..E6.2	YC E1.2..E6.2 110-120 VAC/DC	1SDA073685R1
E1.2..E6.2	YC E1.2..E6.2 120-127 VAC/DC	1SDA073686R1
E1.2..E6.2	YC E1.2..E6.2 220-240 VAC/DC	1SDA073687R1
E1.2..E6.2	YC E1.2..E6.2 240-250 VAC/DC	1SDA073688R1
E1.2..E6.2	YC E1.2..E6.2 277 VAC	1SDA073689R1
E1.2..E6.2	YC E1.2..E6.2 380-400 VAC	1SDA073690R1
E1.2..E6.2	YC E1.2..E6.2 415-440 VAC	1SDA073691R1
E1.2..E6.2	YC E1.2..E6.2 480-500 VAC	1SDA073692R1

Shunt trip and closing coil test unit - YO/YC Test Unit (IEC only)

Size	Type	Global code
E1.2..E6.2	YO/YC test unit E1.2..E6.2	1SDA073707R1

Undervoltage release - YU

Size	Type	Global code
E1.2..E6.2	YU E1.2..E6.2 24 VAC/DC	1SDA073694R1
E1.2..E6.2	YU E1.2..E6.2 30 VAC/DC	1SDA073695R1
E1.2..E6.2	YU E1.2..E6.2 48 VAC/DC	1SDA073696R1
E1.2..E6.2	YU E1.2..E6.2 60 VAC/DC	1SDA073697R1
E1.2..E6.2	YU E1.2..E6.2 110-120 VAC/DC	1SDA073698R1
E1.2..E6.2	YU E1.2..E6.2 120-127 VAC/DC	1SDA073699R1
E1.2..E6.2	YU E1.2..E6.2 220-240 VAC/DC	1SDA073700R1
E1.2..E6.2	YU E1.2..E6.2 240-250 VAC/DC	1SDA073701R1
E1.2..E6.2	YU E1.2..E6.2 277 VAC	1SDA073702R1
E1.2..E6.2	YU E1.2..E6.2 380-400 VAC	1SDA073703R1
E1.2..E6.2	YU E1.2..E6.2 415-440 VAC	1SDA073704R1
E1.2..E6.2	YU E1.2..E6.2 440-500 VAC	1SDA073705R1

The undervoltage release is an alternative to a second shunt trip or anti-racking out device (fail safe)

Electronic time-delay device for undervoltage release - UVD (IEC only)

Size	Type	Global code
E1.2..E6.2	24-30 VDC	1SDA038316R1
E1.2..E6.2	48 VAC/DC	1SDA038317R1
E1.2..E6.2	60 VAC/DC	1SDA038318R1
E1.2..E6.2	110...127 VAC/DC	1SDA038319R1
E1.2..E6.2	220...250 VAC/DC	1SDA038320R1

The electronic time-delay device must be used with an undervoltage release with the same voltage

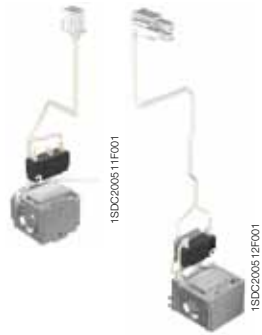

Remote reset - YR

Size	Type	Global code
E1.2	YR 24 VDC E1.2	1SDA073744R1
E1.2	YR 110 VAC/DC E1.2	1SDA073745R1
E1.2	YR 220 VAC/DC E1.2	1SDA073746R1
E2.2..E6.2	YR 24 VDC E2.2...E6.2	1SDA073747R1
E2.2..E6.2	YR 110 VAC/DC E2.2...E6.2	1SDA073748R1
E2.2..E6.2	YR 220 VAC/DC E2.2...E6.2	1SDA073749R1

When the remote reset is used in DC, its activation must be done with a maximum impulse time of 50ms. It can not be powered permanently.



Motor - M

Size	Type	Global code
E1.2	M E1.2 24-30 VAC/DC + MC 250V	1SDA073708R1
E1.2	M E1.2 48-60 VAC/DC + MC 250V	1SDA073709R1
E1.2	M E1.2 100-130 VAC/DC + MC 250V	1SDA073710R1
E1.2	M E1.2 220-250 VAC/DC + MC 250V	1SDA073711R1
E1.2	M E1.2 380-415 VAC + MC 250V	1SDA073713R1
E2.2..E6.2	M E2.2...E6.2 24-30 VAC/DC + MC 400V	1SDA073722R1
E2.2..E6.2	M E2.2...E6.2 48-60 VAC/DC + MC 400V	1SDA073723R1
E2.2..E6.2	M E2.2...E6.2 100-130 VAC/DC + MC 400V	1SDA073724R1
E2.2..E6.2	M E2.2...E6.2 220-250 VAC/DC + MC 400V	1SDA073725R1
E2.2..E6.2	M E2.2...E6.2 277 VAC + MC 400V	1SDA073726R1
E2.2..E6.2	M E2.2...E6.2 380-415 VAC + MC 400V	1SDA073727R1
E2.2..E6.2	M E2.2...E6.2 440-480 VAC + MC 400V	1SDA073728R1
E1.2	M E1.2 24-30 VAC/DC + MC 24V	1SDA073715R1
E1.2	M E1.2 48-60 VAC/DC + MC 24V	1SDA073716R1
E1.2	M E1.2 100-130 VAC/DC + MC 24V	1SDA073717R1
E1.2	M E1.2 220-250 VAC/DC + MC 24V	1SDA073718R1
E1.2	M E1.2 227 VAC + MC 24V	1SDA073733R1
E1.2	M E1.2 380-415 VAC + MC 24V	1SDA073720R1
E2.2..E6.2	M E2.2...E6.2 24-30 VAC/DC + MC 24V	1SDA073729R1
E2.2..E6.2	M E2.2...E6.2 48-60 VAC/DC + MC 24V	1SDA073730R1
E2.2..E6.2	M E2.2...E6.2 100-130 VAC/DC + MC 24V	1SDA073731R1
E2.2..E6.2	M E2.2...E6.2 220-250 VAC/DC + MC 24V	1SDA073732R1
E2.2..E6.2	M E2.2...E6.2 380-415 VAC + MC 24V	1SDA073734R1
E2.2..E6.2	M E2.2...E6.2 440-480 VAC + MC 24V	1SDA073735R1



Current sensor for external neutral

Size	Type	Global code
E1.2-E2.2	Ext CS N E1.2, E2.2 2000A (*)	1SDA073736R1
E2.2	Ext CS N E2.2 (*)	1SDA073737R1
E4.2	Ext CS N E4.2 (*)	1SDA073738R1
E4.2-E6.2	Ext CS N E4.2 3200A, E6.2 50% (*)	1SDA073739R1
E6.2	Ext CS N E6.2 (*)	1SDA073740R1

* Only as loose part



Homopolar toroid for the earthing conductor of the main power supply (Transformer star center sensor input)

Size	Type	Global code
E1.2..E6.2	Homopolar toroid E1.2...E6.2 100A (*)	1SDA073743R1
E1.2..E6.2	Homopolar toroid E1.2...E6.2 250A (*)	1SDA076248R1
E1.2..E6.2	Homopolar toroid E1.2...E6.2 400A (*)	1SDA076249R1
E1.2..E6.2	Homopolar toroid E1.2...E6.2 800A (*)	1SDA076250R1

The homopolar toroid is an alternative to the toroid for differential protection; (*) Only as loose part

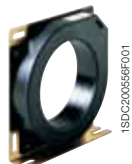

Toroid for differential protection (Rc residual current protection sensor input) (IEC only)

Size	Type	Global code
E1.2 & E2.2 3p	Toroid RC E1.2, E2.2 3p (*)	1SDA073741R1
E2.2 4p & E4.2	Toroide RC E2.2 4p, E4.2 (*)	1SDA073742R1

The toroid for differential protection is an alternative to the homopolar toroid for the earthing conductor of the main power supply; (*) Only as loose part



Accessories

Electrical accessories



1SDC200509F001



1SDC200504F001



1SDC200505F001



1SDC200506F001



1SDC200507F001



1SDC200686F001



1SDC200681F001

Open closed auxiliary contacts - AUX

Size	Type	Global code
E1.2	AUX 4Q (4 Form C) 400V E1.2	1SDA073750R1
E1.2	AUX 4Q (4 Form C) 24V E1.2	1SDA073751R1
E1.2	AUX 2Q (2 Form C) 400V + 2Q (2 Form C) 24V E1.2	1SDA073752R1
E2.2...E6.2	AUX 4Q (4 Form C) 400V E2.2...E6.2	1SDA073753R1
E2.2...E6.2	AUX 4Q (4 Form C) 24V E2.2...E6.2	1SDA073754R1
E2.2...E6.2	AUX 2Q (2 Form C) 400V + 2Q (2 Form C) 24V E2.2...E6.2	1SDA073755R1
E2.2...E6.2	AUX 6Q 400V E2.2...E6.2 ¹⁾	1SDA073756R1
E2.2...E6.2	AUX 6Q 24V E2.2...E6.2 ¹⁾	1SDA073757R1
E2.2...E6.2	AUX 3Q (3 Form C) 400V + 3Q (3 Form C) 24V E2.2...E6.2 ¹⁾	1SDA075973R1
E1.2	AUX 15Q (15 Form C) 400V E1.2 ²⁾	1SDA073758R1
E1.2	AUX 15Q (15 Form C) 24V E1.2 ²⁾	1SDA073759R1
E1.2	Mounting plate for fixed	1SDA062129R1
E1.2	Mounting plate for fixed - on bottom	1SDA062130R1
E1.2	Mounting plate for drawout	1SDA062131R1
E2.2...E6.2	AUX 15Q (15 Form C) 400V (for fixed/drawout with signalling in racked in) E2.2...E6.2 ²⁾	1SDA073760R1
E2.2...E6.2	AUX 15Q (15 Form C) 24V (for fixed/drawout with signalling in racked in) E2.2...E6.2 ²⁾	1SDA073761R1
E2.2...E6.2	AUX 15Q (15 Form C) 400V (for fixed/drawout with signalling in racked in/test isolated) E2.2...E6.2 ²⁾	1SDA073846R1
E2.2...E6.2	AUX 15Q (15 Form C) 24V (for fixed/drawout with signalling in racked in/test isolated) E2.2...E6.2 ²⁾	1SDA073847R1

1) AUX 6Q (6 Form C) is an alternative to the Ekip Signalling 4k module

2) Aux 15 Q (15 Form C) is an alternative to the Mechanical interlock (MI), the lock to prevent door opening when the circuit breaker is in the closed position (DLC) or the lock to prevent door opening when the circuit breaker is in the racked in or test position (DCP) when mounted on the right side. For E1.2 one of the mounting plates is also needed.

Auxiliary position contacts - AUP

Size	Type	Global code
E1.2	AUP 6 contacts 400V E1.2	1SDA073762R1
E1.2	AUP 6 contacts 24V E1.2	1SDA073763R1
E2.2...E6.2	AUP 5 contacts 400V E2.2...E6.2 - left set	1SDA080373R1
E2.2...E6.2	AUP 5 contacts 24V E2.2...E6.2 - left set	1SDA080374R1
E2.2...E6.2	AUP 5 suppl. contacts 400V E2.2...E6.2 - right set	1SDA080375R1
E2.2...E6.2	AUP 5 suppl. contacts 24V E2.2...E6.2 - right set	1SDA080376R1
E1.2...E6.2	AUP Ekip auxiliary position contact E1.2...E6.2	1SDA073768R1

Ready to close signalling contact - RTC

Size	Type	Global code
E1.2	RTC 250V E1.2	1SDA073770R1
E1.2	RTC 24V E1.2	1SDA073771R1
E1.2	RTC Ekip 24V E1.2	1SDA073772R1
E2.2...E6.2	RTC 250V E2.2...E6.2	1SDA073773R1
E2.2...E6.2	RTC 24V E2.2...E6.2	1SDA073774R1
E2.2...E6.2	RTC Ekip 24V E2.2...E6.2	1SDA073775R1

Trip signalling contact - S51 / bell alarm

Size	Type	Global code
E1.2	S51 / bell alarm 250V E1.2	1SDA073776R1
E1.2	S51 / bell alarm 24V E1.2	1SDA073777R1
E2.2...E6.2	S51 / bell alarm 250V E2.2...E6.2	1SDA073778R1
E2.2...E6.2	S51 / bell alarm 24V E2.2...E6.2	1SDA073779R1

Terminal blocks for auxiliary connection

Size	Type	Global code
E1.2...E6.2	Terminal blocks 10 pcs	1SDA073906R1

Accessories

Mechanical accessories



1SDC200524F001



1SDC200516F001



1SDC200516F001



1SDC200517F001

1SDC200518F001

Mechanical operation counter - MOC

Size	Type	Global code
E1.2	MOC mechanical operation counter	1SDA073780R1
E2.2...E6.2	MOC mechanical operation counter	1SDA073781R1

Key lock in open position - KLC

Size	Type	Global code
E1.2	KLC-D Key lock open E1.2	1SDA073782R1
E1.2	KLC-S Key lock open N.20005 E1.2	1SDA073783R1
E1.2	KLC-S Key lock open N.20006 E1.2	1SDA073784R1
E1.2	KLC-S Key lock open N.20007 E1.2	1SDA073785R1
E1.2	KLC-S Key lock open N.20008 E1.2	1SDA073786R1
E1.2	KLC-S Key lock open N.20009 E1.2	1SDA073787R1
E1.2	KLA Key lock open Castell E1.2 ¹⁾²⁾	1SDA073788R1
E1.2	KLA Key lock open Kirk E1.2 ¹⁾	1SDA073789R1
E1.2	KLA Key lock open Ronis Profalux E1.2 ¹⁾	1SDA073790R1
E2.2...E6.2	KLC-D Key lock open E2.2...E6.2	1SDA073791R1
E2.2...E6.2	KLC-S Key lock open N.20005 E2.2...E6.2	1SDA073792R1
E2.2...E6.2	KLC-S Key lock open N.20006 E2.2...E6.2	1SDA073793R1
E2.2...E6.2	KLC-S Key lock open N.20007 E2.2...E6.2	1SDA073794R1
E2.2...E6.2	KLC-S Key lock open N.20008 E2.2...E6.2	1SDA073795R1
E2.2...E6.2	KLC-S Key lock open N.20009 E2.2...E6.2	1SDA073796R1
E2.2...E6.2	KLA Key lock open Castell E2.2...E6.2 ¹⁾²⁾	1SDA073797R1
E2.2...E6.2	KLA Key lock open Kirk E2.2...E6.2 ¹⁾	1SDA073798R1
E2.2...E6.2	KLA Key lock open Ronis Profalux E2.2...E6.2 ¹⁾	1SDA073799R1

1) Arrangement only: 2) Only mounted. For loose supply contact ABB SACE.

Padlocks in open position - PLC

Size	Type	Global code
E1.2	PLC E1.2 Padlock open D=4mm/0.15"	1SDA073800R1
E1.2	PLC E1.2 Padlock open D=7mm/0.27"	1SDA073801R1
E1.2	PLC E1.2 Padlock open D=8mm/0.31"	1SDA073802R1
E2.2...E6.2	PLC E2.2...E6.2 Padlock open D=4mm/0.15"	1SDA073803R1
E2.2...E6.2	PLC E2.2...E6.2 Padlock open D=7mm/0.27"	1SDA073804R1
E2.2...E6.2	PLC E2.2...E6.2 Padlock open D=8mm/0.31"	1SDA073805R1

The PLC is an alternative to the protection device for opening and closing pushbuttons (PBC)

Fixed or Mobile Part with neutral on right side

Size	Type	Global code
E1.2...E6.2	Installation with neutral on right side sequence L1, L2, L3, N	1SDA076153R1

Accessories

Mechanical accessories



Key lock in racked in / test / racked out position - KLP

Size	Type	Global code
E1.2	KLP-D Key lock racked in/out E1.2 1st key	1SDA073822R1
E1.2	KLP-S Key lock racked in/out N.20005 E1.2 1st key	1SDA073823R1
E1.2	KLP-S Key lock racked in/out N.20006 E1.2 1st key	1SDA073824R1
E1.2	KLP-S Key lock racked in/out N.20007 E1.2 1st key	1SDA073825R1
E1.2	KLP-S Key lock racked in/out N.20008 E1.2 1st key	1SDA073826R1
E1.2	KLP-S Key lock racked in/out N.20009 E1.2 1st key	1SDA073827R1
E1.2	KLP-D Key lock racked in/out E1.2 2nd key	1SDA073828R1
E1.2	KLP-S Key lock racked in/out N.20005 E1.2 2nd key	1SDA073829R1
E1.2	KLP-S Key lock racked in/out N.20006 E1.2 2nd key	1SDA073830R1
E1.2	KLP-S Key lock racked in/out N.20007 E1.2 2nd key	1SDA073831R1
E1.2	KLP-S Key lock racked in/out N.20008 E1.2 2nd key	1SDA073832R1
E1.2	KLP-S Key lock racked in/out N.20009 E1.2 2nd key	1SDA073833R1
E1.2	KLP-A Key lock racked in/out RonProfKirk E1.2 1st key ²⁾	1SDA073834R1
E1.2	KLP-A Key lock racked in/out RonProfKirk E1.2 2nd key ²⁾	1SDA073835R1
E1.2	KLP-A Key lock racked in/out Castell E1.2 1st key ¹⁾²⁾	1SDA073836R1
E1.2	KLP-A Key lock racked in/out Castell E1.2 2nd key ¹⁾²⁾	1SDA073837R1
E2.2...E6.2	KLP-D Key lock racked in/out E2.2...E6.2 1st key	1SDA073806R1
E2.2...E6.2	KLP-S Key lock racked in/out N.20005 E2.2...E6.2 1st key	1SDA073807R1
E2.2...E6.2	KLP-S Key lock racked in/out N.20006 E2.2...E6.2 1st key	1SDA073808R1
E2.2...E6.2	KLP-S Key lock racked in/out N.20007 E2.2...E6.2 1st key	1SDA073809R1
E2.2...E6.2	KLP-S Key lock racked in/out N.20008 E2.2...E6.2 1st key	1SDA073810R1
E2.2...E6.2	KLP-S Key lock racked in/out N.20009 E2.2...E6.2 1st key	1SDA073811R1
E2.2...E6.2	KLP-D Key lock racked in/out E2.2...E6.2 2nd key	1SDA073812R1
E2.2...E6.2	KLP-S Key lock racked in/out N.20005 E2.2...E6.2 2nd key	1SDA073813R1
E2.2...E6.2	KLP-S Key lock racked in/out N.20006 E2.2...E6.2 2nd key	1SDA073814R1
E2.2...E6.2	KLP-S Key lock racked in/out N.20007 E2.2...E6.2 2nd key	1SDA073815R1
E2.2...E6.2	KLP-S Key lock racked in/out N.20008 E2.2...E6.2 2nd key	1SDA073816R1
E2.2...E6.2	KLP-S Key lock racked in/out N.20009 E2.2...E6.2 2nd key	1SDA073817R1
E2.2...E6.2	KLP-A Key lock racked in/out RonProfKirk E2.2...E6.2 1st key ²⁾	1SDA073818R1
E2.2...E6.2	KLP-A Key lock racked in/out RonProfKirk E2.2...E6.2 2nd key ²⁾	1SDA073819R1
E2.2...E6.2	KLP-A Key lock racked in/out Castell E2.2...E6.2 1st key ¹⁾²⁾	1SDA073820R1
E2.2...E6.2	KLP-A Key lock racked in/out Castell E2.2...E6.2 2nd key ¹⁾²⁾	1SDA073821R1

To have 2 keys, one each of a 1st key and 2nd key option must be ordered. When the Padlock in racked in/test/racked out (PLP) is also present, the 2nd key option must be ordered.

1) Two Castell key options can not be used together; 2) Arrangement only

Supplementary lock in racked out position accessory

Size	Type	Global code
E1.2	Suppl. lock in racked out E1.2	1SDA073838R1
E2.2...E6.2	Suppl. lock in racked out E2.2...E6.2	1SDA073839R1

Padlock in racked in / test / racked out position - PLP

Size	Type	Global code
E1.2	PLP Padlock racked in/out E1.2	1SDA073840R1
E2.2...E6.2	PLP Padlock racked in/out E2.2...E6.2	1SDA073841R1

Can also be used with the key lock in racked in/test/racked out device when the 2nd key option is ordered.

Anti-racking out device (fail safe) - FS

Size	Type	Global code
E1.2	Fail Safe E1.2	1SDA079898R1
E2.2...E6.2	Fail Safe E2.2...E6.2	1SDA079899R1





1SDC200886F001



1SDC200923F001

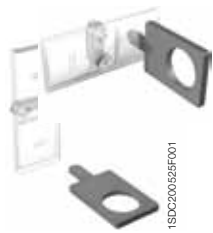

1SDC200959F001



1SDC200927F001

1SDC200928F001



1SDC200929F001



1SDC200930F001



1SDC200931F001

Lock for racking in / racking out the mobile part when the door is open - DLR

Size	Type	Global code
E1.2...E6.2	DLR E2.2...E6.2 (*)	1SDA073845R1

(*) Only as loose part

Lock to prevent door opening when the circuit breaker is in racked in / test position - DLP

Size	Type	Global code
E2.2...E6.2	DLR E2.2...E6.2 (*)	1SDA073849R1

If mounted on the right side, the DLP is an alternative to the mechanical interlock, AUX 15Q (15 Form C) or Lock to prevent door opening when the circuit breaker is in a closed position (DLC); (*) Only as loose part

Lock to prevent door opening when the circuit breaker is in a closed position - DLC

Size	Type	Global code
E1.2	DLC Interlock cable door E1.2	1SDA073850R1
E1.2	DLC Interlock direct door E1.2	1SDA073851R1
E2.2...E6.2	DLC Interlock cable door E2.2...E6.2 (*)	1SDA073852R1
E2.2...E6.2	DLC Interlock direct door E2.2...E6.2 (*)	1SDA073853R1

If mounted on the right side, the DLP is an alternative to the mechanical interlock, AUX 15Q (15 Form C) or Lock to prevent door opening when the circuit breaker is in racked in / test position (DLP); * To be ordered with lever for interlock [group 2] and support for interlock [1SDA073895R1]

Protection device for opening and closing pushbuttons - PBC

Size	Type	Global code
E1.2	PBC Op/Ci BP protection sp. key E1.2	1SDA073854R1
E1.2	PBC Op/Ci BP protection PL D=4mm/0.15" E1.2	1SDA073855R1
E1.2	PBC Op/Ci BP protection PL D=7mm/0.27" E1.2	1SDA073856R1
E1.2	PBC Op/Ci BP protection PL D=8mm/0.31" E1.2	1SDA073857R1
E2.2...E6.2	PBC Op/Ci BP protection sp. key E2.2...E6.2	1SDA073858R1
E2.2...E6.2	PBC Op/Ci BP protection PL D=4mm/0.15" E2.2...E6.2	1SDA073859R1
E2.2...E6.2	PBC Op/Ci BP protection PL D=7mm/0.27" E2.2...E6.2	1SDA073860R1
E2.2...E6.2	PBC Op/Ci BP protection PL D=8mm/0.31" E2.2...E6.2	1SDA073861R1

* The PBC is an alternative to the Padlock in open position (PLC)

Circuit breaker flange / door escutcheon

Size	Type	Global code
E1.2	IP30 flange E1.2 Fixed	1SDA073862R1
E1.2	IP30 flange E1.2 Drawout	1SDA073863R1
E2.2...E6.2	IP30 flange E2.2...E6.2 Fixed	1SDA073864R1
E2.2...E6.2	IP30 flange E2.2...E6.2 Drawout	1SDA073865R1
E1.2	IP54 flange, different keys E1.2 (*)	1SDA073866R1
E2.2...E6.2	IP54 flange, different keys E2.2...E6.2 (*)	1SDA073867R1
E1.2	IP54 flange, key N.20005 E1.2 (*)	1SDA073868R1
E2.2...E6.2	IP54 flange, key N.20005 E2.2...E6.2 (*)	1SDA073869R1
E2.2...E6.2	Sealable trip unit cover E2.2...E6.2	1SDA073870R1

* Only as loose part

High or low terminal covers - HTC/LTC

Size	Type	3 poles	4 poles
		Global code	Global code
E1.2	HTC high terminal covers E1.2 2pcs	1SDA073871R1	1SDA073872R1
E1.2	LTC low terminal covers E1.2 2pcs	1SDA073873R1	1SDA073874R1

Separators - PB

Size	Type	Global code
E1.2	PB H=100mm/3.94" 4pcs E1.2 Fixed 3P	1SDA073877R1
E1.2	PB H=100mm/3.94" 6pcs E1.2 Fixed 4P	1SDA073878R1
E1.2	PB H=200mm/7.87" 4pcs E1.2 Fixed 3P	1SDA073879R1
E1.2	PB H=200mm/7.87" 6pcs E1.2 Fixed 4P	1SDA073880R1
E1.2	PB 2pcs E1.2 Drawout 3P	1SDA076164R1
E1.2	PB 3pcs E1.2 Drawout 4P	1SDA076165R1
E2.2...E6.2	PB 2pcs E2.2...E6.2 Fixed 3P	1SDA076166R2
E2.2...E6.2	PB 3pcs E2.2...E6.2 Fixed 4P	1SDA076167R3
E2.2...E6.2	PB 2pcs E2.2...E6.2 Drawout 3P	1SDA076168R4
E2.2...E6.2	PB 3pcs E2.2...E6.2 Drawout 4P	1SDA076169R5

Accessories

Mechanical interlock

Cables for mechanical interlock [Group 1]

Size	Type	Global code
E1.2..E6.2	Type A horizontal	1SDA073881R1
E2.2..E6.2	Type B,C,D horizontal	1SDA073882R1
E1.2..E6.2	Type A vertical	1SDA073885R1
E2.2..E6.2	Type B,C,D vertical	1SDA073886R1

On type of cable must be ordered for each interlock. The cable must be ordered with the fixed circuit breaker or the cradle of a drawout circuit breaker.

Lever for mechanical interlock of fixed circuit breaker or cradle [Group 2]

Size	Type	3 Poles	4 Poles
		Global code	Global code
E2.2	Lever for mechanical interlock	1SDA073889R1	1SDA073889R1
E4.2	Lever for mechanical interlock	1SDA073890R1	1SDA073890R1
E6.2	Lever for mechanical interlock	1SDA073891R1	1SDA073892R1

The lever for the mechanical interlock is not required for E1.2

Support for mechanical interlock of fixed circuit breaker [Group 3]

Size	Type	Global code
E1.2	Type A	1SDA073893R1
E1.2	Type A - Installed on bottom plate	1SDA073894R1
E2.2 ... E6.2	Type A / B / D	1SDA073895R1
E2.2 ... E6.2	Type C	1SDA073897R1

Support for mechanical interlock of fixed part [Group 4]

Size	Type	Global code
E1.2	Type A	1SDA073896R1
E2.2 ... E6.2	Type A / B / D	1SDA073895R1
E2.2 ... E6.2	Type C	1SDA073897R1

Automatic transfer switch

Size	Type	Global code
E1.2..E6.2	ATS021	1SDA065523R1
E1.2..E6.2	ATS022	1SDA065524R1



Accessories

Ekip modules



Ekip trip units - loose supply

Size	Type	Global code
E1.2..E6.2	Ekip Dip LI	1SDA074194R1
E1.2..E6.2	Ekip Dip LSI	1SDA074195R1
E1.2..E6.2	Ekip Dip LSIG	1SDA074196R1
E1.2..E6.2	Ekip Touch LI (*)	1SDA074197R1
E1.2..E6.2	Ekip Touch LSI (*)	1SDA074198R1
E1.2..E6.2	Ekip Touch LSIG (*)	1SDA074199R1
E1.2..E6.2	Ekip G Touch LSIG (*)	1SDA074200R1
E1.2..E6.2	Ekip Hi-Touch LSI (*)	1SDA074201R1
E1.2..E6.2	Ekip Hi-Touch LSIG (*)	1SDA074202R1
E1.2..E6.2	Ekip G Hi-Touch LSIG (*)	1SDA074203R1
E1.2..E6.2	Ekip LCD LI (*)	1SDA074204R1
E1.2..E6.2	Ekip LCD LSI (*)	1SDA074205R1
E1.2..E6.2	Ekip LCD LSIG (*)	1SDA074206R1
E1.2..E6.2	Ekip G LCD LSIG (*)	1SDA074207R1
E1.2..E6.2	Ekip Hi-LCD LSI (*)	1SDA074208R1
E1.2..E6.2	Ekip Hi-LCD LSIG (*)	1SDA074209R1
E1.2..E6.2	Ekip G Hi-LCD LSIG (*)	1SDA074210R1
E1.2..E6.2	Battery for Ekip trip units	1SDA074193R1

* Ekip TT standard supply

Options for Ekip trip units

Size	Type	Global code
E1.2..E6.2	Ekip LCD installed	1SDA074211R1
E1.2..E6.2	Ekip Power Controller	1SDA074212R1
E1.2..E6.2	Upper internal installed voltage outlets	1SDA074216R1
E1.2..E6.2	External installed voltage outlets	1SDA074217R1
E1.2..E6.2	Arrangement for cables with lower internal voltage outlets	1SDA074213R1
E1.2..E6.2	Arrangement for cables with upper internal voltage outlets	1SDA074214R1
E1.2..E6.2	Arrangement for cables with external voltage outlets	1SDA074215R1

Power Supply modules

Size	Type	Global code
E1.2..E6.2	Ekip Supply 110-240VAC/DC	1SDA074172R1
E1.2..E6.2	Ekip Supply 24-48VDC	1SDA074173R1

Connectivity modules

Size	Type	Global code
E1.2..E6.2	Ekip Com Modbus RS-485	1SDA074150R1
E1.2..E6.2	Ekip Com Modbus TCP	1SDA074151R1
E1.2..E6.2	Ekip Com Profibus	1SDA074152R1
E1.2..E6.2	Ekip Com Profinet	1SDA074153R1
E1.2..E6.2	Ekip Com DeviceNet	1SDA074154R1
E1.2..E6.2	Ekip Com EtherNet/IP	1SDA074155R1
E1.2..E6.2	Ekip Com IEC61850	1SDA074156R1
E1.2..E6.2	Ekip Com R Modbus RS-485	1SDA074157R1
E1.2..E6.2	Ekip Com R Modbus TCP	1SDA074158R1
E1.2..E6.2	Ekip Com R Profibus	1SDA074159R1
E1.2..E6.2	Ekip Com R Profinet	1SDA074160R1
E1.2..E6.2	Ekip Com R DeviceNet	1SDA074161R1
E1.2..E6.2	Ekip Com R EtherNet/IP	1SDA074162R1
E1.2..E6.2	Ekip Link	1SDA074163R1
E1.2..E6.2	Ekip Bluetooth	1SDA074164R1
E1.2..E6.2	Ekip Com GPRS-M	1SDA074165R1
E1.2..E6.2	Ekip Com Actuator	1SDA074166R1



Accessories

Ekip modules



1SDC200544F001



1SDC200548F001



1SDC200688F001



1SDC200558F001



1SDC200559F001

Signalling modules

Size	Type	Global code
E1.2..E6.2	Ekip 2K-1	1SDA074167R1
E1.2..E6.2	Ekip 2K-2	1SDA074168R1
E1.2..E6.2	Ekip 2K-3	1SDA074169R1
E2.2..E6.2	Ekip 4K ¹⁾	1SDA074170R1
E1.2..E6.2	Ekip 10K ²⁾	1SDA074171R1

1) Ekip 4k is not available for the E1.2. It is an alternative to the AUX 6Q (6 Form C) auxiliary contacts unit on other frames; 2) only as loose part

Measuring and Measuring Pro modules

Size	Type	Global code
E1.2	Ekip Measuring	1SDA074184R1
E1.2	Ekip Measuring Pro	1SDA074185R1
E2.2	Ekip Measuring	1SDA074186R1
E2.2	Ekip Measuring Pro	1SDA074187R1
E4.2	Ekip Measuring	1SDA074188R1
E4.2	Ekip Measuring Pro	1SDA074189R1
E6.2	Ekip Measuring	1SDA074190R1
E6.2	Ekip Measuring Pro	1SDA074191R1
E1.2	Voltage socket for neutral on the right side L1 L2 L3 L3 N - E1.2(*)	1SDA076244R1
E2.2	Voltage socket for neutral on the right side L1 L2 L3 L3 N - E2.2(*)	1SDA076245R1
E4.2	Voltage socket for neutral on the right side L1 L2 L3 L3 N - E4.2(*)	1SDA076246R1
E6.2	Voltage socket for neutral on the right side L1 L2 L3 L3 N - E6.2(*)	1SDA076247R1

* use only with circuit breakers with neutral on right side L1 L2 L3 N

Synchrocheck module

Size	Type	Global code
E1.2..E6.2	Ekip Synchrocheck	1SDA074183R1

Displaying and supervision systems

Size	Type	Global code
E1.2..E6.2	Ekip T&P - Programming and Test unit	1SDA066989R1
E1.2..E6.2	Ekip TT - Trip Test	1SDA066988R1
E1.2..E6.2	Ekip Programming	1SDA076154R1
E1.2..E6.2	Ekip Multimeter Display for the front of switchgear (*)	1SDA074192R1
E1.2..E6.2	Ekip Control Panel for 10 circuit breakers	1SDA074311R1
E1.2..E6.2	Ekip Control Panel for 30 circuit breakers	1SDA074312R1
E1.2..E6.2	Ekip Control Panel license extension to 30 circuit breakers	1SDA074313R1
E1.2..E6.2	Ekip Control Panel alarm dispatcher option	1SDA074314R1
E1.2..E6.2	Ekip Control Panel option 5 web client accesses	1SDA074315R1
E1.2..E6.2	Ekip View Software for 30 circuit breakers	1SDA074298R1
E1.2..E6.2	Ekip View Software for 60 circuit breakers	1SDA074299R1
E1.2..E6.2	Ekip View Software for unlimited circuit breakers	1SDA074300R1
E1.2..E6.2	Ekip View license extension to 60 circuit breakers	1SDA074301R1
E1.2..E6.2	Ekip View license extension to unlimited circuit breakers	1SDA074302R1
E1.2..E6.2	Ekip View alarm dispatcher option for 30 circuit breakers	1SDA074303R1
E1.2..E6.2	Ekip View alarm dispatcher option for 60 circuit breakers	1SDA074304R1
E1.2..E6.2	Ekip View alarm dispatcher option for unlimited circuit breakers	1SDA074305R1
E1.2..E6.2	Ekip View 5 web client accesses license of 30 circuit breakers	1SDA074306R1
E1.2..E6.2	Ekip View 5 web client accesses license of 60 circuit breakers	1SDA074307R1
E1.2..E6.2	Ekip View 5 web client accesses license of unlimited circuit breakers	1SDA074308R1
E1.2..E6.2	Ekip View redundancy option	1SDA074309R1
E1.2..E6.2	Ekip View OPC server client option	1SDA074310R1

* only as loose part



1SDC20054F001

Rating plugs for Ekip trip units

Size	Type	Global code (loose supply)	Global code (installed)
E1.2...E2.2	Rating Plug 100A	1SDA074218R1	1SDA074258R1
E1.2...E2.2	Rating Plug 200A	1SDA074219R1	1SDA074259R1
E1.2...E2.2	Rating Plug 250A	1SDA074220R1	1SDA074260R1
E1.2..E6.2	Rating Plug 400A	1SDA074221R1	1SDA074261R1
E1.2..E6.2	Rating Plug 600A ²⁾	1SDA079826R1	1SDA079826R1
E1.2..E6.2	Rating Plug 630A ¹⁾	1SDA074222R1	1SDA074262R1
E1.2..E6.2	Rating Plug 800A	1SDA074223R1	1SDA074263R1
E1.2..E6.2	Rating Plug 1000A	1SDA074224R1	1SDA074264R1
E1.2..E6.2	Rating Plug 1200A ²⁾	1SDA079730R1	1SDA079828R1
E1.2..E6.2	Rating Plug 1250A ¹⁾	1SDA074225R1	1SDA074265R1
E1.2..E6.2	Rating Plug 1600A ³⁾	1SDA074226R1	1SDA074266R1
E2.2...E6.2	Rating Plug 2000A	1SDA074227R1	1SDA074267R1
E2.2...E6.2	Rating Plug 2500A ⁴⁾	1SDA074228R1	1SDA074268R1
E4.2...E6.2	Rating Plug 3200A	1SDA074229R1	1SDA074269R1
E6.2	Rating Plug 3600A ²⁾	1SDA079827R1	1SDA079829R1
E4.2...E6.2	Rating Plug 4000A ⁵⁾	1SDA074230R1	1SDA074270R1
E6.2	Rating Plug 5000A	1SDA074231R1	1SDA074271R1
E6.2	Rating Plug 6000A ²⁾	1SDA079731R1	-
E6.2	Rating Plug 6300A ¹⁾	1SDA074232R1	1SDA074272R1
E1.2..E2.2	Rating Plug 100A L OFF ¹⁾	1SDA074233R1	1SDA074273R1
E1.2..E2.2	Rating Plug 200A L OFF ¹⁾	1SDA074234R1	1SDA074274R1
E1.2..E2.2	Rating Plug 250A L OFF ¹⁾	1SDA074235R1	1SDA074275R1
E1.2..E6.2	Rating Plug 400A L OFF ¹⁾	1SDA074236R1	1SDA074276R1
E1.2..E6.2	Rating Plug 630A L OFF ¹⁾	1SDA074237R1	1SDA074277R1
E1.2..E6.2	Rating Plug 800A L OFF ¹⁾	1SDA074238R1	1SDA074278R1
E1.2..E6.2	Rating Plug 1000A L OFF ¹⁾	1SDA074239R1	1SDA074279R1
E1.2..E6.2	Rating Plug 1250A L OFF ¹⁾	1SDA074240R1	1SDA074280R1
E1.2..E6.2	Rating Plug 1600A L OFF ¹⁾	1SDA074241R1	1SDA074281R1
E2.2..E6.2	Rating Plug 2000A L OFF ¹⁾	1SDA074242R1	1SDA074282R1
E2.2..E6.2	Rating Plug 2500A L OFF ¹⁾	1SDA074243R1	1SDA074283R1
E4.2..E6.2	Rating Plug 3200A L OFF ¹⁾	1SDA074244R1	1SDA074284R1
E4.2..E6.2	Rating Plug 4000A L OFF ¹⁾	1SDA074245R1	1SDA074285R1
E6.2	Rating Plug 5000A L OFF ¹⁾	1SDA074246R1	1SDA074286R1
E6.2	Rating Plug 6300A L OFF ¹⁾	1SDA074247R1	1SDA074287R1
E1.2..E2.2	Rating Plug RC 100A ¹⁾	1SDA074248R1	1SDA074288R1
E1.2..E2.2	Rating Plug RC 200A ¹⁾	1SDA074249R1	1SDA074289R1
E1.2..E2.2	Rating Plug RC 250A ¹⁾	1SDA074250R1	1SDA074290R1
E1.2..E6.2	Rating Plug RC 400A ¹⁾	1SDA074251R1	1SDA074291R1
E1.2..E6.2	Rating Plug RC 630A ¹⁾	1SDA074252R1	1SDA074292R1
E1.2..E6.2	Rating Plug RC 800A ¹⁾	1SDA074253R1	1SDA074293R1
E1.2..E6.2	Rating Plug RC 1250A ¹⁾	1SDA074254R1	1SDA074294R1
E2.2..E6.2	Rating Plug RC 2000A ¹⁾	1SDA074255R1	1SDA074295R1
E4.2..E6.2	Rating Plug RC 3200A ¹⁾	1SDA074256R1	1SDA074296R1
E4.2..E6.2	Rating Plug RC 4000A ¹⁾	1SDA074257R1	1SDA074297R1

1) IEC only

2) UL only

3) IEC only for E1.2, both UL and IEC for all other frames

4) IEC only for E2.2, both UL and IEC for E4.2 and E6.2

5) IEC only for E4.2, both UL and IEC for E6.2

Accessories

Terminals

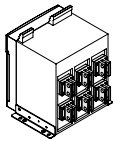

Rear orientable terminal - HR VR

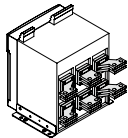

Horizontal rear spread terminal - SHR

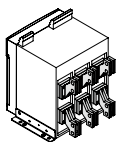

Vertical rear spread terminal - SVR

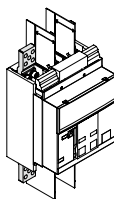

Extended front terminal - EF

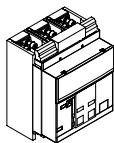

Front terminal - F

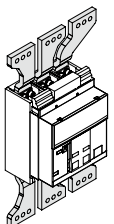

Front spread terminal - ES

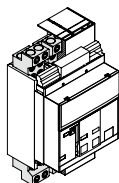

Terminal for cable FcCuAl
4x240mm² - Fc CuAl

Kit for terminals - installed on fixed circuit breaker

Size	Version	Max amperage	Type	3 Poles		4 Poles	
				Global code		Global code	
E1.2	F	1200	Kit EF Upper	1SDA073963R1		1SDA073964R1	
E1.2	F	1200	Kit EF Lower	1SDA073965R1		1SDA073966R1	
E1.2	F	1200	Kit ES Upper	1SDA073975R1		1SDA073976R1	
E1.2	F	1200	Kit ES Lower	1SDA073977R1		1SDA073978R1	
E1.2	F	1200	Kit HR Upper	1SDA079840R1		1SDA079841R1	
E1.2	F	1200	Kit HR Lower	1SDA079842R1		1SDA079843R1	
E1.2	F	1200	Kit VR Upper	1SDA079836R1		1SDA079837R1	
E1.2	F	1200	Kit VR Lower	1SDA079838R1		1SDA079839R1	
E1.2	F	1200	Kit FcCuAl 4x 500kcmil/240mm ² Upper	1SDA073997R1		1SDA073998R1	
E1.2	F	1200	Kit FcCuAl 4x 500kcmil/240mm ² Lower	1SDA073999R1		1SDA074000R1	
E2.2	F	2000	Kit F Upper	1SDA074118R1		1SDA074119R1	
E2.2	F	2000	Kit F Lower	1SDA074120R1		1SDA074121R1	
E2.2	F	2000	Kit VR Upper	1SDA079852R1		1SDA079853R1	
E2.2	F	2000	Kit VR Lower	1SDA079854R1		1SDA079855R1	
E4.2	F	3200	Kit F Upper	1SDA074126R1		1SDA074127R1	
E4.2	F	3200	Kit F Lower	1SDA074128R1		1SDA074129R1	
E4.2	F	2500	Kit VR Upper	1SDA079862R1		1SDA079863R1	
E4.2	F	2500	Kit VR Lower	1SDA079864R1		1SDA079865R1	
E6.2	F	6000	Kit F Upper	1DSA074134R1		1DSA074135R1	
E6.2	F	6000	Kit F Lower	1DSA074137R1		1DSA074138R1	
E6.2	F	5000	Kit VR Upper	1SDA079891R1		1SDA079892R1	
E6.2	F	5000	Kit VR Lower	1SDA079893R1		1SDA079894R1	
E6.2/f	F	6000	Kit F Upper	-		1DSA074136R1	
E6.2/f	F	6000	Kit F Lower	-		1DSA074138R1	

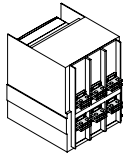

Rear orientable terminal - HR VR

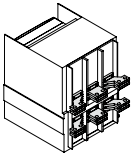

Horizontal rear terminal - SHR

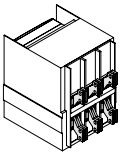

Vertical rear spread terminal - SVR

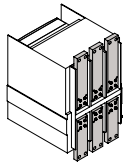

Front terminal - F

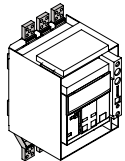

Extended front terminal - EF

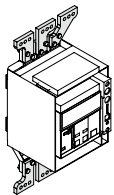

Front spread terminal - ES

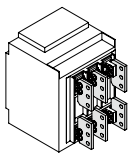

Terminal for cable FcCuAl
4x240mm² - Fc CuAl

Kit for terminals - installed on cradle

Size	Version	Max amperage	Type	3 Poles		4 Poles	
				Global code		Global code	
E1.2	W	1200	Kit EF Upper	1SDA073939R1		1SDA073940R1	
E1.2	W	1200	Kit EF Lower	1SDA073941R1		1SDA073942R1	
E1.2	W	1200	Kit ES Upper ¹⁾	1SDA073951R1		1SDA073952R1	
E1.2	W	1200	Kit ES Lower ¹⁾	1SDA073953R1		1SDA073954R1	
E1.2	W	1200	Kit VR Upper	1SDA079830R1		1SDA079831R1	
E1.2	W	1200	Kit VR Lower	1SDA079832R1		1SDA079833R1	
E1.2	W	1200	Kit FcCuAl 4x 500kcmil/240mm ² Upper	1SDA073991R1		1SDA073993R1	
E1.2	W	1200	Kit FcCuAl 4x 500kcmil/240mm ² Lower	1SDA073992R1		1SDA073994R1	
E2.2	W	2000	Kit F Upper	1SDA074090R1		1SDA074091R1	
E2.2	W	2000	Kit F Lower	1SDA074092R1		1SDA074093R1	
E2.2	W	2000	Kit VR Upper	1SDA079846R1		1SDA079847R1	
E2.2	W	2000	Kit VR Lower	1SDA079848R1		1SDA079849R1	
E4.2	W	3200	Kit F Upper	1SDA074098R1		1SDA074099R1	
E4.2	W	3200	Kit F Lower	1SDA074100R1		1SDA074101R1	
E4.2	W	2500	Kit VR Upper	1SDA079856R1		1SDA079857R1	
E4.2	W	2500	Kit VR Lower	1SDA079858R1		1SDA079859R1	
E6.2	W	6000	Kit F Upper	1SDA074106R1		1SDA074107R1	
E6.2	W	6000	Kit F Lower	1SDA074109R1		1SDA074110R1	
E6.2	W	5000	Kit VR Upper	1SDA079882R1		1SDA079883R1	
E6.2	W	5000	Kit VR Lower	1SDA079885R1		1SDA079886R1	
E6.2/f	W	6000	Kit F Upper	-		1SDA074108R1	
E6.2/f	W	6000	Kit F Lower	-		1SDA074111R1	
E6.2/f	W	5000	Kit VR Upper	-		1SDA079884R1	
E6.2/f	W	5000	Kit VR Lower	-		1SDA079887R1	

1) ES terminals can be ordered only if the cradle also has EF terminals.

2) Vertical terminals are supplied as standard for E4.2, 3200A. For this size and amperage, HR is not possible.

Accessories

Terminals

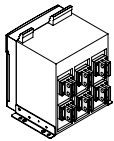

Rear orientable terminal - HR VR

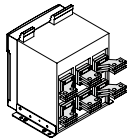

Horizontal rear spread terminal - SHR

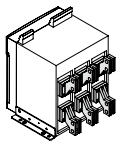

Vertical rear spread terminal - SVR

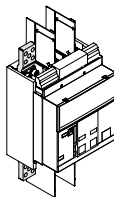

Extended front terminal - EF

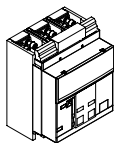

Front terminal - F

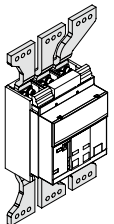

Front spread terminal - ES

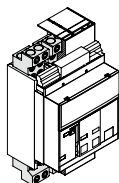

Terminal for cable FcCuAl
4x240mm² - Fc CuAl

Kit for terminals - loose supply for one side of fixed circuit breaker

Size	Version	Max amperage	Type	3 Poles		4 Poles	
				Global code		Global code	
E1.2	F	1200	Kit EF	1SDA073967R1		1SDA073968R1	
E1.2	F	1200	Kit F	1SDA073973R1		1SDA073973R1	
E1.2	F	1200	Kit ES	1SDA073979R1		1SDA073980R1	
E1.2	F	1200	Kit Adjustable HR/VR	1SDA079844R1		1SDA079845R1	
E1.2	F	1200	Kit FcCuAl 4x500kcmil/240mm ²	1SDA074001R1		1SDA074002R1	
E2.2	F	2000	Kit F Upper	1SDA074122R1		1SDA074123R1	
E2.2	F	2000	Kit F Lower	1SDA074124R1		1SDA074125R1	
E2.2	F	2000	Adjustable HR/VR	1SDA079850R1		1SDA079851R1	
E4.2	F	3200	Kit F Upper	1SDA074130R1		1SDA074131R1	
E4.2	F	3200	Kit F Lower	1SDA074132R1		1SDA074133R1	
E4.2	F	2500	Kit Adjustable HR/VR	1SDA079860R1		1SDA079861R1	
E4.2	F	3200	Kit VR	1SDA079866R1		1SDA079867R1	
E6.2	F	6000	Kit F Upper	1SDA074140R1		1SDA074141R1	
E6.2	F	6000	Kit F Lower	1SDA074143R1		1SDA074144R1	
E6.2	F	5000	Kit Adjustable HR/VR	1SDA079888R1		1SDA079889R1	
E6.2	F	6000	Kit VR	1SDA079895R1		1SDA079896R1	
E6.2/f	F	6000	Kit F Upper	-		1SDA074142R1	
E6.2/f	F	6000	Kit F Lower	-		1SDA074145R1	
E6.2/f	F	5000	Kit Adjustable HR/VR	-		1SDA079890R1	
E6.2/f	F	6000	Kit VR	-		1SDA079897R1	

Adapter plate for terminals - loose supply for fixed circuit breaker

Size	Version	Iu	Type	3 Poles		4 Poles	
				Global code		Global code	
E2.2	F	2000	Kit Terminal Adapter Plate	1SDA074146R1		1SDA074147R1	
E4.2	F	3200	Kit Terminal Adapter Plate	1SDA074148R1		1SDA074149R1	

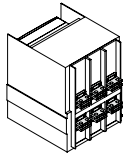

Rear orientable terminal - HR VR

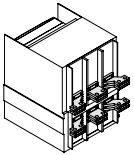

Horizontal rear terminal - SHR

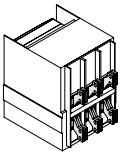

Vertical rear spread terminal - SVR

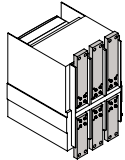

Front terminal - F

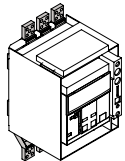

Extended front terminal - EF

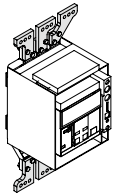

Front spread terminal - ES

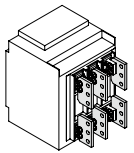

Terminal for cable FcCuAl
4x240mm² - Fc CuAl

Kit for terminals - loose supply for one side of cradle

Size	Version	Max amperage	Type	3 Poles		4 Poles	
				Global code		Global code	
E1.2	W	1200	Kit EF	1SDA073943R1		1SDA073944R1	
E1.2	W	1200	Kit ES 1)	1SDA073955R1		1SDA073956R1	
E1.2	W	1200	Kit Adjustable HR/VR	1SDA079834R1		1SDA079835R1	
E1.2	W	1200	Kit FcCuAl 4x 500kcmil/240mm ²	1SDA073995R1		1SDA073996R1	
E2.2	W	2000	Kit F Upper	1SDA074094R1		1SDA074095R1	
E2.2	W	2000	Kit F Lower	1SDA074096R1		1SDA074097R1	
E2.2	W	2000	Kit Adjustable HR/VR	1SDA079850R1		1SDA079851R1	
E4.2	W	3200	Kit F Upper	1SDA074102R1		1SDA074103R1	
E4.2	W	3200	Kit F Lower	1SDA074104R1		1SDA074105R1	
E4.2	W	2500	Kit Adjustable HR/VR	1SDA079860R1		1SDA079861R1	
E4.2	W	3200	Kit VR	1SDA079866R1		1SDA079867R1	
E6.2	W	6000	Kit F Upper	1SDA074112R1		1SDA074113R1	
E6.2	W	6000	Kit F Lower	1SDA074115R1		1SDA074116R1	
E6.2	W	5000	Kit Adjustable HR/VR	1SDA079888R1		1SDA079889R1	
E6.2	W	6000	Kit VR	1SDA079895R1		1SDA079896R1	
E6.2/f	W	6000	Kit F Upper	-		1SDA074114R1	
E6.2/f	W	6000	Kit F Lower	-		1SDA074117R1	
E6.2/f	W	5000	Kit Adjustable HR/VR	-		1SDA079890R1	
E6.2/f	W	6000	Kit VR	-		1SDA079897R1	

1) ES terminals can be ordered only if the cradle also has EF terminals.

Contact us

ABB SACE

A division of ABB S.p.A.

L.V. Breakers

Via Pescaria, 5

24123 Bergamo

Phone: +39 035 395.111

Fax: +39 035 395.306-433

www.abb.com

The data and illustrations are not binding. We reserve the right to modify the contents of this document on the basis of technical development of the products, without prior notice.

Copyright 2014 ABB. All rights reserved.

1SDC200039D0201 - 2014.12