

Reliability connects

Klippon® Connect sets standards with clamping yoke technology

Whatever your requirements for the panel: our screw connection system with patented clamping yoke technology ensures the ultimate in contact safety. You can use both screw-in and plug-in cross-connections for potential distribution. Two conductors of the same diameter can also be connected in a single terminal point in accordance with UL1059. The screw connection has long been an established connection element to meet exacting demands in terms of reliability and functionality. And our W-Series is still setting standards.



Our promise

The high reliability and variety of designs of the terminal blocks with clamping yoke connections make planning easier and optimises operational safety. Klippon® Connect provides a proven response to a range of different requirements.

Flexibility

- The maintenance-free connection means the clamping screw does not need to be re-tightened
- Can be clipped to or removed from the terminal rail in either direction

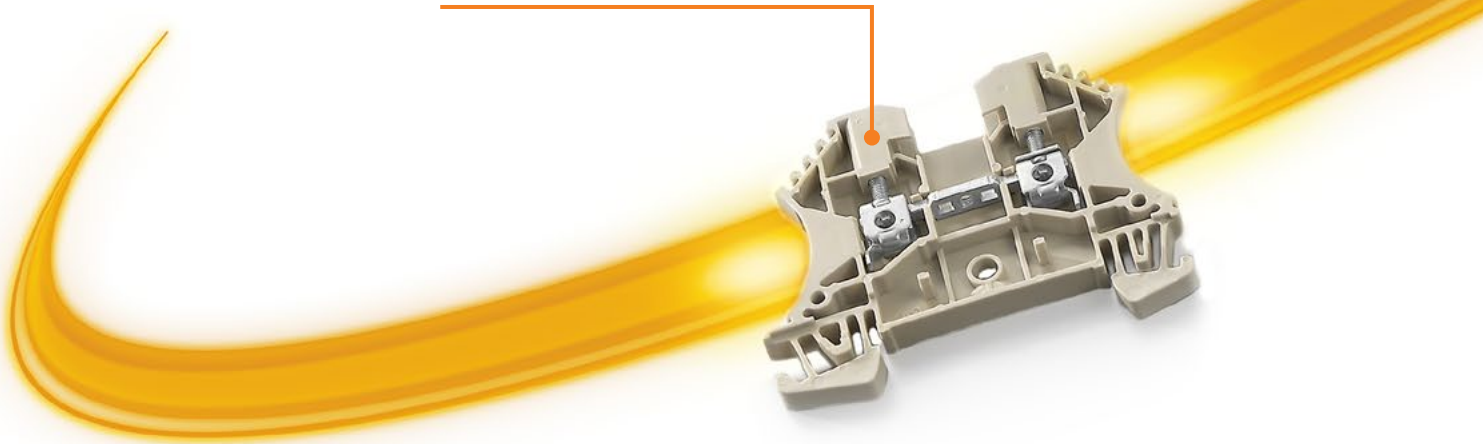

Time saving

- Quick installation as the products are delivered with clamping yoke open
- Identical contours for easier planning

Space saving

- Small „W-Compact“ size saves space in the panel
- Two conductors can be connected for each contact point

Safety

- The clamping yoke properties compensate for temperature-indexed changes to the conductor to prevent loosening
- Vibration-resistant connectors – ideal for applications in harsh conditions
- Protection against incorrect conductor entry
- Copper current bar for low voltages, clamping yoke and screw made of hardened steel
- Precise clamping yoke and current bar design for safe contact with even the smallest of conductors

Overview

You can rely on it: thanks to the range of models and real flexibility, our terminal blocks with clamping yoke technology can be used in a wide range of different applications.

Universal application:

Numerous national and international approvals and qualifications in accordance with a variety of application standards make the W-series a universal connection solution, especially in harsh conditions.

Varied product assortment with wide clamping range:

Our terminal blocks with clamping yoke technology are available in both standard and compact designs. The compact design covers wire cross-sections from 0.05 mm² to 150 mm² and helps save space in the panel. The standard version covers conductor cross sections of up to 240 mm². The identical contours of the terminal blocks make configuration easier and reduces the quantity of accessories required.

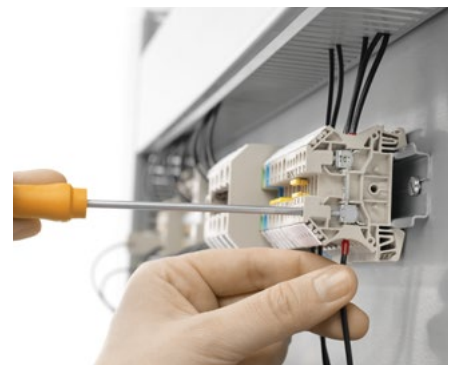

Screw connection with clamping yoke technology (W-Series)
Feed-through terminal blocks

Universal range

A

WDU 1.5/R 3.5

1.5 mm²

Feed-through terminal for TS 15

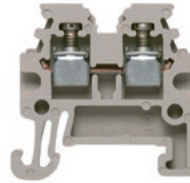

Width/Height/Depth	mm
max. current / max. cond. cross-section	A/mm ²
Max. clamping range	mm ²

3.5 x 24.5 x 24	
17.5 / 1.5	
0.13...1.5	

Technical data

Rated data	
Rated voltage	V
Rated current	A
for wire cross-section	mm ²
Rated impulse withstand voltage / Pollution severity	
Gauge to IEC 60947-1 / UL 94 flammability rating	
Approvals	
Clamped conductors (H05V/H07V)	
Solid / Stranded	mm ²
Flexible / Flexible with ferrule	mm ²
Tightening torque (clamping screw for copper conductors)	-
Stripping length / Blade size	mm/-
2 conductors with same cross-section (H05V/H07V)	
Solid / Stranded	mm ²
Flexible / Flexible with ferrule	mm ²
Note	

IEC 60947-7-1	Ex e II		II 2 G D
IEC	UL	CSA	EN 60079-7
400	300	300	275
17.5	15	10	14
1.5	AWG 26...14	AWG 26...14	1.5 mm ²
4 kV / 3			
A1 / V-0			
			KEMA99ATEX6545U
Rated connection	Further connection		
0.5...1.5 / 1.5...1.5			
0.5...1.5 / 0.5...1.5	2.5		
0.3 Nm / (M 2)			
7 / 0.4 x 2.5 mm			
Rated connection	Further connection		
0.5...0.75			
0.5...0.75 / 0.5...0.5			
Note	PZ 6/5 recommended as crimping tool for 1.5 mm ² with wire-end ferrule		

Ordering data

Version	
	dark beige
	beige
	blue
Note	

Type	Qty.	Order No.
WDU 1.5/R3.5	100	1753280000
WDU 1.5/R3.5 BL	100	1754170000

Accessories

Screwable cross-connection	
	2-pole
	10-pole
End plate / Partition plate	
	dark beige
	Blue
End bracket	
	dark beige
Testing / Checking	
	Test plug
	Socket
Identification systems	
Pluggable cross-connection	
	2-pole
	10-pole

Type	current	Qty.	Order No.
WAP WDU1.5/R3.5		20	1754190000
EW 15		50	0382860000
DEK 5/3.5 MC NE WS		500	1755270000
DEK 5/3.5 MM WS		1000	2007100000
WS 8/3.5 MM WS		1000	2007140000
ZQV 1.5N/R3.5/2 GE	17.5 A	50	1754210000
ZQV 1.5N/R3.5/10 GE	17.5 A	20	1754290000

For detailed information on other accessories and application in the online catalogue

Cross-connections, see section "W series accessories".

AKZ 1.5

1.5 mm²

Feed-through terminal for TS 15

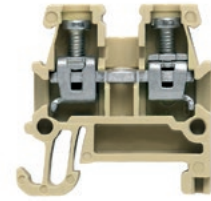

5.1 x 24.8 x 24	
24 / 2.5	
0.21...2.5	

IEC 60947-7-1		II 2 G D
IEC	UL	CSA
250	150	300
17.5	15	10
1.5	AWG 22...14	AWG 24...16
4 kV / 3		
A1 / V-2		
		SIRA02ATEX3001U
Rated connection	Further connection	
0.5...2.5 / 1.5...1.5		
0.5...1.5 / 0.5...1.5		
0.4...0.6 Nm / (M 2.5)		
7 / 3.0 x 0.5 mm		
Rated connection	Further connection	
0.5...1		

Type	Qty.	Order No.
AKZ 1.5	100	0340460000
AKZ 1.5 BL	100	0340480000

AKZ 1.5 order No. 0340460000 and 0340480000 made of PA with flammability rating acc. to UL 94/V-2

Type	current	Qty.	Order No.
Q 2 AKZ1.5	24 A	50	0368200000
Q 10 AKZ1.5	24 A	20	0368500000
AP AKZ1.5		50	0340560000
AP AKZ1.5 BL		50	0340580000
EW 15		50	0382860000
PS 2.3 RT		20	0180400000
STB 8.5/D4/2.3/M2.5 AKZ		50	0215700000
DEK 5/5 MC NE WS		1000	1609801044

Cross-connections, see section "W series accessories".

WDU 1.5/ZZ

1.5 mm²

Twin connection

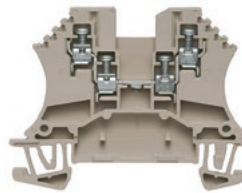

Width/Height/Depth	mm
max. current / max. cond. cross-section	A/mm ²
Max. clamping range	mm ²

5.1 x 60 x 46.5
23 / 2.5
0.13...2.5

Technical data

Rated data	
Rated voltage	V
Rated current	A
for wire cross-section	mm ²
Rated impulse withstand voltage / Pollution severity	
Gauge to IEC 60947-1 / UL 94 flammability rating	
Approvals	
Clamped conductors (H05V/H07V)	
Solid / Stranded	mm ²
Flexible / Flexible with ferrule	mm ²
Tightening torque (clamping screw for copper conductors)	-
Stripping length / Blade size	mm/-
2 conductors with same cross-section (H05V/H07V)	
Solid / Stranded	mm ²
Flexible / Flexible with ferrule	mm ²
Note	

Ordering data

Version	
	dark beige
	blue
Note	

Accessories

Pluggable cross-connection	
	2-pole
	10-pole
Screwable cross-connection	
	2-pole
	10-pole
End plate / Partition plate	
	dark beige
	Blue
	dark beige
	Blue
End bracket	
	dark beige
Testing / Checking	
	Standard
	With spigot
Cover	
	With lightning flash symbol
	Blank, white
Identification systems	

IEC 60947-7-1	Ex e II	Ex	II 2 G D
IEC	UL	CSA	EN 60079-7
800	300	300	440
17.5	25	10	17.5
1.5	AWG 26...12	AWG 26...12	2.5 mm ²
8 kV / 3			
A1 / V-0			
CE CB IEC KEMA NEMA UL DEMKO14ATEX1338U			
Rated connection		Further connection	
0.5...2.5 / 0.5...2.5			
0.5...1.5 / 0.5...1.5			
0.4...0.6 Nm / (M 2.5)			
7 / 0.6 x 3.5 mm			
0.5...1			
0.5...1 / 0.5...0.75			
Note			
Note the max. current of the terminal (23 A) when using the WDV cross-connector!			

Type	Qty.	Order No.
WDU 1.5/ZZ	100	1031400000
WDU 1.5/ZZ BL	100	1031480000

Type	current	Qty.	Order No.
ZQV 2.5N/2	24 A	60	1527540000
ZQV 2.5N/10	24 A	20	1527690000
WQV 2.5/2	32 A	50	1053660000
WQV 2.5/10	32 A	20	1054460000
WAP 2.5-10		50	1050000000
WAP 2.5-10 BL		50	1050080000
WAP 16+35 WTW 2.5-10		20	1050100000
WAP 16+35 WTW 2.5-10 BL		20	1050180000
WEW 35/2		100	1061200000
WTA 2 WDU2.5-10		25	1632320000
WTA 2/ZA WDU2.5-10		25	1632330000
WAD 4 GE BED		50	1072000000
WAD 4 WS		50	1072100000
DEK 5/5 MC NE WS		1000	1609801044
WS 12/5 MC NE WS		720	1609860000
DEK 5/5 MM WS		800	2007110000
WS 8/5 MM WS		800	2007150000

Cross-connections, socket and test plug, see section "W series accessories".

For detailed information on other accessories and application in the online catalogue

WDU 2.5/1.5/ZR

2.5 mm²

Supplementary connection, right

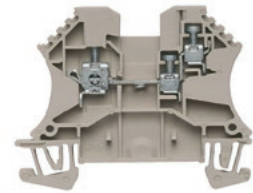

5.1 x 60 x 46.5
32 / 4
0.05...4

IEC 60947-7-1	Ex e II	Ex	II 2 G D
IEC	UL	CSA	EN 60079-7
800	300	300	690
24	20	20	24
2.5	AWG 30...12	AWG 26...14	2.5 mm ²
8 kV / 3			
A3, A1 / V-0			
CE CB IEC KEMA NEMA UL DEMKO14ATEX1338U			
Rated connection		Further connection	
0.5...4 / 1.5...4		0.5...2.5 / 0.5...2.5	
0.5...4 / 0.5...2.5		0.5...1.5 / 0.5...1.5	
0.4...0.6 Nm / (M 2.5)			
10 / 0.6 x 3.5 mm		7 / SD 0.6 x 3.5	
0.5...1			
0.5...1.5 / 0.5...1.5			
Note			
2.5 mm ² conductor with ferrule with plastic collar, with the collar optimised for diameter only (order No. 1333100000, QTY 500).			

Type	Qty.	Order No.
WDU 2.5/1.5/ZR	100	1024700000
WDU 2.5/1.5/ZR BL	100	1024780000

The rated voltage is 400 V when using the ZQV cross-connector, additional connection (right 1.5 mm²)

Type	current	Qty.	Order No.
ZQV 2.5N/2	24 A	60	1527540000
ZQV 2.5N/10	24 A	20	1527690000
WQV 2.5/2	32 A	50	1053660000
WQV 2.5/10	32 A	20	1054460000
WAP 2.5-10		50	1050000000
WAP 2.5-10 BL		50	1050080000
WAP 16+35 WTW 2.5-10		20	1050100000
WAP 16+35 WTW 2.5-10 BL		20	1050180000
WEW 35/2		100	1061200000
WTA 2 WDU2.5-10		25	1632320000
WTA 2/ZA WDU2.5-10		25	1632330000
DEK 5/5 MC NE WS		1000	1609801044
WS 12/5 MC NE WS		720	1609860000
DEK 5/5 MM WS		800	2007110000
WS 8/5 MM WS		800	2007150000

Note: Use a 2.5 / 1 mm² conductor with the WQB. Cross-connections, see section "W series accessories".

Screw connection with clamping yoke technology (W-Series)

Feed-through terminal blocks

Universal range

A

AKZ 2.5

2.5 mm²

Feed-through terminal for TS 15



WDU 2.5

2.5 mm²

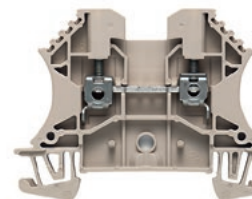

Width/Height/Depth	mm
max. current / max. cond. cross-section	A/mm ²
Max. clamping range	mm ²

5.1 x 25.5 x 26.3	
32 / 4	
0.13...4	

5.1 x 60 x 46.5	
32 / 4	
0.05...4	

Technical data

Rated data	
Rated voltage	V
Rated current	A
for wire cross-section	mm ²
Rated impulse withstand voltage / Pollution severity	Gauge to IEC 60947-1 / UL 94 flammability rating
Approvals	
Clamped conductors (H05V/H07V)	
Solid / Stranded	mm ²
Flexible / Flexible with ferrule	mm ²
Tightening torque (clamping screw for copper conductors)	-
Stripping length / Blade size	mm/-
2 conductors with same cross-section (H05V/H07V)	
Solid / Stranded	mm ²
Flexible / Flexible with ferrule	-
Note	

IEC 60947-1	Ex e II		II 2 G D
IEC	UL	CSA	EN 60079-7
250	300	300	176
24	10	10	21
2.5	AWG 26...12	AWG 26...10	2.5 mm ²
4 kV / 3			
A3 / V-2			
			SIRA02ATEX3001U
Rated connection		Further connection	
0.5...4 / 1.5...2.5			
0.5...2.5 / 0.5...2.5			
0.4...0.6 Nm / (M 2.5)			
7 / 3.0 x 0.5 mm			
0.5...1.5			

IEC 60947-1	Ex e II		II 2 G D
IEC	UL	CSA	EN 60079-7
800	600	600	690
24	25	20	24
2.5	AWG 30...12	AWG 26...12	2.5 mm ²
8 kV / 3			
A3 / V-0			
			DEMKO14ATEX1338U
Rated connection		Further connection	
0.5...4 / 1.5...4			
0.5...4 / 0.5...2.5			
0.4...0.8 Nm / (M 2.5)			
10 / 0.6 x 3.5 mm			
0.5...1.5			
0.5...1.5 / 0.5...1.5			
2.5 mm ² conductor with ferrule with plastic collar, with the collar optimised for diameter only (order No. 1333100000, QTY 500).			

Ordering data

Version	dark beige
	beige
	blue
Note	

Type	Qty.	Order No.
AKZ 2.5	100	0697160000
AKZ 2.5 BL	100	0697180000
AKZ 2.5 order No. 0697160000 and 0697180000 made of PA with flammability rating acc. to UL 94/V-2		

Type	Qty.	Order No.
WDU 2.5	100	1020000000
WDU 2.5 BL	100	1020080000
Rated voltage is 400 V when using the cross-connector. For colour versions, see section on W-series Accessories		

Accessories

Pluggable cross-connection	
	2-pole
	10-pole
Screwable cross-connection	
	2-pole
	10-pole
End plate / Partition plate	
	dark beige
	Blue
	dark beige
	Blue
End bracket	
	dark beige
Testing / Checking	
	Standard
	With spigot
	Test plug
	Socket
Cover	
	Blank, yellow
	Blank, white
	With lightning flash symbol
Identification systems	
	DEK 5/5 MC NE WS
For detailed information on other accessories and application in the online catalogue	

Type	current	Qty.	Order No.
Q 2 AKZ1.5	24 A	50	0368200000
Q 10 AKZ1.5	24 A	20	0368500000
AP AKZ2.5		50	0697360000
AP AKZ2.5 BL		50	0697380000
TW AKZ2.5		20	0318560000
EW 15		50	0382860000
PS 2.3 RT		20	0180400000
STB 8.5/D4/2.3/M2.5 AKZ		50	0215700000
Cross-connections, see section "W series accessories".			

Type	current	Qty.	Order No.
ZQV 2.5N/2	24 A	60	1527540000
ZQV 2.5N/10	24 A	20	1527690000
WQV 2.5/2	32 A	50	1053660000
WQV 2.5/10	32 A	20	1054460000
WAP 2.5-10		50	1050000000
WAP 2.5-10 BL		50	1050080000
WAP 16+35 WTW 2.5-10		20	1050100000
WAP 16+35 WTW 2.5-10 BL		20	1050180000
WEW 35/2		100	1061200000
WTA 2 WDU2.5-10		25	1632320000
WTA 2/ZA WDU2.5-10		25	1632330000
WAD 5 MC NE GE		48	1112920000
WAD 5 MC NE WS		48	1112910000
DEK 5/5 MC NE WS		1000	1609801044
WS 12/5 MC NE WS		720	1609860000
DEK 5/5 MM WS		800	2007110000
WS 8/5 MM WS		800	2007150000
Ensure 2.5 mm ² max. when using the WQB. Only 400 V with the use of shield bus LS 2.8 1056400000.			

WDU 2.5 HV

2.5 mm²

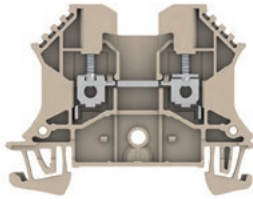

5.1 x 60 x 46.5
32 / 4
0.05...4



IEC 60947-7-1

IEC	UL	CSA	EN 60079-7
1000			
24			
2.5			
8 kV / 3			
A3 / V-0			

Rated connection	Further connection
0.5...4 / 1.5...4	
0.5...4 / 0.5...2.5	
0.4...0.6 Nm / (M 2.5)	
10 / 0.6 x 3.5 mm	
0.5...1.5 / 0.5...1.5	

Type	Qty.	Order No.
WDU 2.5 HV	100	1412950000

Type	current	Qty.	Order No.
ZQV 2.5N/2	24 A	60	1527540000
ZQV 2.5N/10	24 A	20	1527690000
WQV 2.5/2	32 A	50	1053660000
WQV 2.5/10	32 A	20	1054460000
WAP 2.5-10		50	1050000000
WAP 2.5-10 BL		50	1050080000
WAP 16+35 WTW 2.5-10		20	1050100000
WAP 16+35 WTW 2.5-10 BL		20	1050180000
WEW 35/2		100	1061200000
WTA 2 WDU2.5-10		25	1632320000
WTA 2/ZA WDU2.5-10		25	1632330000
WAD 5 MC NE GE		48	1112920000
WAD 5 MC NE WS		48	1112910000
DEK 5/5 MC NE WS		1000	1609801044
WS 12/5 MC NE WS		720	1609860000
DEK 5/5 MM WS		800	2007110000
WS 8/5 MM WS		800	2007150000

WDU 2.5N

2.5 mm²

With screwable cross-connection
Compact design

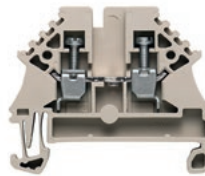

5.1 x 44 x 37
32 / 4
0.05...4

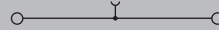

IEC 60947-7-1

Ex e II II 2 G D

IEC	UL	CSA	EN 60079-7
500	300	300	352
24	20	20	24
2.5	AWG 22...12	AWG 26...12	2.5 mm ²
6 kV / 3			
A3 / V-0			

Rated connection	Further connection
0.5...4 / 1.5...4	
0.5...4 / 0.5...2.5	
0.4...0.6 Nm / (M 2.5)	
10 / 0.6 x 3.5 mm	
0.5...1.5 / 0.5...1.5	

2.5 mm² conductor with ferrule with plastic collar, with the collar optimised for diameter only (order No. 1333100000, QTY 500).

Type	Qty.	Order No.
WDU 2.5N	100	1023700000
WDU 2.5N BL	100	1023780000

Colour variants listed under the W-Series accessories section, "Specific functions".

Type	current	Qty.	Order No.
WQV 2.5/2	32 A	50	1053660000
WQV 2.5/10	32 A	20	1054460000
WAP WDU2.5N/4N		50	1060000000
WAP WDU2.5N/4N BL		50	1060080000
EW 35		50	0383560000
WTA 1 WDU1.5		25	1632290000
WTA 1/ZA WDU1.5		25	1632300000
WAD 4 WS		50	1072100000
WAD 4 GE BED		50	1072000000
DEK 5/5 MC NE WS		1000	1609801044
WS 12/5 MC NE WS		720	1609860000
DEK 5/5 MM WS		800	2007110000
WS 8/5 MM WS		800	2007150000

Socket and test plug, see section "W-Series accessories".

WDU 2.5N/ZQV

2.5 mm²

With pluggable cross-connection
Compact design

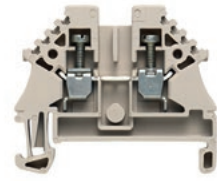

5.1 x 44 x 37
32 / 4
0.05...4



IEC 60947-7-1

IEC	UL	CSA	EN 60079-7
500		300	
24		25	
2.5		AWG 26...12	
6 kV / 3			
A3 / V-0			

Rated connection	Further connection
0.5...4 / 1.5...4	
0.5...4 / 0.5...2.5	
0.4...0.6 Nm / (M 2.5)	
10 / 0.6 x 3.5 mm	
0.5...1.5 / 0.5...1.5	

2.5 mm² conductor with ferrule with plastic collar, with the collar optimised for diameter only (order No. 1333100000, QTY 500).

Type	Qty.	Order No.
WDU 2.5N ZQV	100	1040800000
WDU 2.5N ZQV BL	100	1040880000

Rated voltage is 400 V when using the ZQV cross-connector.

Type	current	Qty.	Order No.
ZQV 2.5N/2	24 A	60	1527540000
ZQV 2.5N/10	24 A	20	1527690000
WAP WDU2.5N/4N		50	1060000000
WAP WDU2.5N/4N BL		50	1060080000
EW 35		50	0383560000
WTA 1 WDU1.5		25	1632290000
WTA 1/ZA WDU1.5		25	1632300000
WAD 4 WS		50	1072100000
WAD 4 GE BED		50	1072000000
DEK 5/5 MC NE WS		1000	1609801044
WS 12/5 MC NE WS		720	1609860000
DEK 5/5 MM WS		800	2007110000
WS 8/5 MM WS		800	2007150000

Cross-connections, see section "W series accessories".



Screw connection with clamping yoke technology (W-Series)

Feed-through terminal blocks

Universal range

A

WDU 2.5N/600 UL

2.5 mm²

Compact design

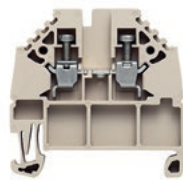

AKZ 4

4 mm²

Feed-through terminal for TS 15



Width/Height/Depth	mm
max. current / max. cond. cross-section	A/mm ²
Max. clamping range	mm ²

5.1 x 44 x 42.7
32 / 4
0.05...4

6.1 x 27 x 29
41 / 6
0.13...6

Technical data

Rated data	
Rated voltage	V
Rated current	A
for wire cross-section	mm ²
Rated impulse withstand voltage / Pollution severity	
Gauge to IEC 60947-1 / UL 94 flammability rating	
Approvals	
Clamped conductors (H05V/H07V)	
Solid / Stranded	mm ²
Flexible / Flexible with ferrule	mm ²
Tightening torque (clamping screw for copper conductors)	-
Stripping length / Blade size	mm/-
2 conductors with same cross-section (H05V/H07V)	
Solid / Stranded	mm ²
Flexible / Flexible with ferrule	-
Note	

IEC 60947-7-1			
IEC	UL	CSA	EN 60079-7
800	600	600	
24	25	20	
2.5	AWG 22...12	AWG 26...12	
8 kV / 3			
A3 / V-0			
CE CB IEC VDE			
Rated connection		Further connection	
0.5...4 / 1.5...4			
0.5...4 / 0.5...2.5			
0.4...0.6 Nm / (M 2.5)			
10 / 0.6 x 3.5 mm			
0.5...1.5 / 0.5...1.5			
/ 0.5...1.5			
2.5 mm ² conductor with ferrule with plastic collar, with the collar optimised for diameter only (order No. 1333100000, QTY 500).			

IEC 60947-7-1				Ex e II II 2 G D			
IEC	UL	CSA	EN 60079-7	IEC	UL	CSA	EN 60079-7
400	300	300	275	400	300	300	275
32	27	10	28	32	27	10	28
4	AWG 26...12	AWG 24...12	4 mm ²	4	AWG 26...12	AWG 24...12	4 mm ²
6 kV / 3				6 kV / 3			
A3 / V-2				A3 / V-2			
CE CB IEC VDE				SIRA02ATEX3001U			
Rated connection		Further connection		Rated connection		Further connection	
0.5...6 / 1.5...4				0.5...6 / 1.5...4			
0.5...4 / 0.5...2.5				0.5...4 / 0.5...2.5			
0.6...0.8 Nm / (M 3)				0.6...0.8 Nm / (M 3)			
8 / 0.6 x 3.5 mm				8 / 0.6 x 3.5 mm			
0.5...1.5 / 0.5...1.5				0.5...1.5 / 0.5...1.5			

Ordering data

Version	dark beige
	beige
	blue
Note	

Type	Qty.	Order No.
WDU 2.5N/600UL	100	1730940000

Type	Qty.	Order No.
AKZ 4	100	0294360000
AKZ 4 BL	100	0294380000
AKZ 4 order No. 0294360000 and 0294380000 made of PA with flammability rating acc. to UL 94/V-2		

Accessories

Pluggable cross-connection		2-pole	
		10-pole	
Screwable cross-connection		2-pole	
		10-pole	
End plate / Partition plate		dark beige	
		Blue	
		dark beige	
		Blue	
End bracket		dark beige	
Testing / Checking		Standard	
		With spigot	
		Test plug	
		Socket	
Cover		Blank, white	
		Blank, yellow	
		With lightning flash symbol	
Identification systems			
For detailed information on other accessories and application in the online catalogue			

Type	current	Qty.	Order No.
WQV 2.5/2	32 A	50	1053660000
WQV 2.5/10	32 A	20	1054460000
WAP WDU2.5N/4N		50	1060000000
WAP WDU2.5N/4N BL		50	1060080000
WEW 35/2		100	1061200000
WTA 1 WDU1.5		25	1632290000
WTA 1/ZA WDU1.5		25	1632300000
WAD 4 WS		50	1072100000
WAD 4 GE BED		50	1072000000
WS 12/5 MC NE WS		720	1609860000
DEK 5/5 MC NE WS		1000	1609801044
WS 8/5 MM WS		800	2007150000
DEK 5/5 MM WS		800	2007110000
Socket and test plug, see section "W-Series accessories".			

Type	current	Qty.	Order No.
Q 2 AKZ4	32 A	50	0336400000
Q 10 AKZ4	32 A	20	0368600000
AP AKZ4		20	0294460000
AP AKZ4 BL		20	0294480000
TW AKZ4		50	0348260000
EW 15		50	0382860000
PS 2.3 RT		20	0180400000
STB 8.5/D4/2.3/M2.5 AKZ		50	0215700000
DEK 5/6 MC NE WS		1000	1609820000
Cross-connections, see section "W series accessories".			

WDU 4

4 mm²

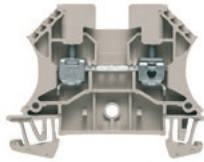

6.1 x 60 x 46.5
41 / 6
0.13...6



IEC 60947-7-1 Ex e II II 2 G D

IEC	UL	CSA	EN 60079-7
800	600	600	690
32	35	35	32
4	AWG 26...10	AWG 26...10	4 mm ²

8 kV / 3

A4 / V-0

DEMKO14ATEX1338U

Rated connection	Further connection
0.5...6 / 1.5...6	
0.5...6 / 0.5...4	
0.5...1 Nm / (M 3)	
10 / 0.6 x 3.5 mm	
0.5...2.5	
0.5...1.5 / 0.5...1.5	

Rated voltage is 400 V when using the ZQV cross-connector.
Note max. current of terminal (41 A) when using WQV!

Type	Qty.	Order No.
WDU 4	100	1020100000
WDU 4 BL	100	1020180000

1000 VDC rated voltage tested. Rated voltage is 400 V when using the cross-connector. For alternative colours, see section on W-series accessories

Type	current	Qty.	Order No.
ZQV 4N/2	32 A	60	1527930000
ZQV 4N/10	32 A	20	1528090000
WQV 4/2	32 A	50	1051960000
WQV 4/10	41 A	20	1052060000
WAP 2.5-10		50	1050000000
WAP 2.5-10 BL		50	1050080000
WAP 16+35 WTW 2.5-10		20	1050100000
WAP 16+35 WTW 2.5-10 BL		20	1050180000
WEW 35/2		100	1061200000
WTA 3 WDU4		25	1632350000
WTA 3/ZA WDU4		25	1632360000
WAD 5 MC NE WS		48	1112910000
WAD 5 MC NE GE		48	1112920000
WS 12/6 MC NE WS		600	1609900000
WS 8/6 MM WS		600	2007160000
DEK 5/6 MM WS		600	2007120000

Socket and test plug, see section "W series accessories". Only 400 V with the use of shield bus LS 2.8 1056400000.

WDU 4 HV

4 mm²

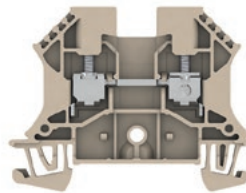

6.1 x 60 x 46.5
41 / 6
0.13...6



IEC 60947-7-1

IEC	UL	CSA	EN 60079-7
1000			
32			
4			

8 kV / 3

A4 / V-0

DEMKO14ATEX1338U

Rated connection	Further connection
0.5...6 / 1.5...6	
0.5...6 / 0.5...4	
0.5...1 Nm / (M 3)	
10 / 0.6 x 3.5 mm	
0.5...2.5	
0.5...1.5 / 0.5...1.5	

Type	Qty.	Order No.
WDU 4 HV	100	1412960000

Type	current	Qty.	Order No.
ZQV 4N/2	32 A	60	1527930000
ZQV 4N/10	32 A	20	1528090000
WQV 4/2	32 A	50	1051960000
WQV 4/10	41 A	20	1052060000
WAP 2.5-10		50	1050000000
WAP 2.5-10 BL		50	1050080000
WAP 16+35 WTW 2.5-10		20	1050100000
WAP 16+35 WTW 2.5-10 BL		20	1050180000
WEW 35/2		100	1061200000
WTA 3 WDU4		25	1632350000
WTA 3/ZA WDU4		25	1632360000
WAD 5 MC NE WS		48	1112910000
WAD 5 MC NE GE		48	1112920000
WS 12/6 MC NE WS		600	1609900000
DEK 5/6 MC NE WS		1000	1609820000
WS 8/6 MM WS		600	2007160000
DEK 5/6 MM WS		600	2007120000

Socket and test plug, see section "W series accessories". Only 400 V with the use of shield bus LS 2.8 1056400000.

WDU 4/ZZ

4 mm²

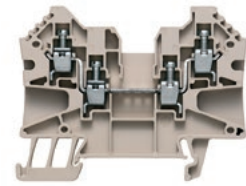

6.1 x 70 x 53
32 / 6
0.05...6



IEC 60947-7-1

IEC	UL	CSA	EN 60079-7
800	600	600	690
32	30	30	29.5
4	AWG 30...10	AWG 30...10	4 mm ²

8 kV / 3

A4 / V-0

DEMKO14ATEX1338U

Rated connection	Further connection
0.5...6	
0.5...4 / 0.5...4	
0.5...0.8 Nm / (M 3)	
10 / 0.6 x 3.5 mm	
0.5...1.5 / 0.5...1.5	

Type	Qty.	Order No.
WDU 4/ZZ	50	1905060000
WDU 4/ZZ BL	50	1114720000

Type	current	Qty.	Order No.
ZQV 4N/2	32 A	60	1527930000
ZQV 4N/10	32 A	20	1528090000
WAP WDU/WTR4/ZZ		50	1905150000
WEW 35/2		100	1061200000
WS 12/6 MC NE WS		600	1609900000
DEK 5/6 MC NE WS		1000	1609820000
WS 8/6 MM WS		600	2007160000
DEK 5/6 MM WS		600	2007120000

Cross-connections, see section "W series accessories".



Screw connection with clamping yoke technology (W-Series)
Feed-through terminal blocks

Universal range

A

WDU 4/ZR

4 mm²

Supplementary connection, right

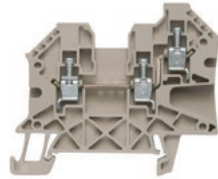

Width/Height/Depth	mm
max. current / max. cond. cross-section	A/mm ²
Max. clamping range	mm ²

6.1 x 63.5 x 53	
32 / 6	
0.05...6	

Technical data

Rated data	
Rated voltage	V
Rated current	A
for wire cross-section	mm ²
Rated impulse withstand voltage / Pollution severity	
Gauge to IEC 60947-1 / UL 94 flammability rating	
Approvals	
Clamped conductors (H05V/H07V)	
Solid / Stranded	mm ²
Flexible / Flexible with ferrule	mm ²
Tightening torque (clamping screw for copper conductors)	-
Stripping length / Blade size	mm/-
2 conductors with same cross-section (H05V/H07V)	
Solid / Stranded	mm ²
Flexible / Flexible with ferrule	mm ²
Note	

IEC 60947-7-1	Ex e II		II 2 G D
IEC	UL	CSA	EN 60079-7
800	600	600	690
32	30	30	31
4	AWG 30...10	AWG 30...10	4 mm ²
8 kV / 3			
A4 / V-0			
CE DEMKO14ATEX1338U			
Rated connection	Further connection		
0.5...6	0.5...6		
0.5...4 / 0.5...4	0.5...4 / 0.5...4		
0.5...0.8 Nm / (M 3)			
10 / 0.6 x 3.5 mm			
0.5...1.5			
0.5...1.5 / 0.5...1.5			

Ordering data

Version	
	dark beige
	blue
Note	

Type	Qty.	Order No.
WDU 4/ZR	50	1905140000

Accessories

Pluggable cross-connection	
	2-pole
	10-pole
End plate / Partition plate	
	dark beige
	Blue
End bracket	
	dark beige
Testing / Checking	
	Standard
	With spigot
Cover	
	With lightning flash symbol
	Blank, white
Identification systems	

Type	current	Qty.	Order No.
ZQV 4N/2	32 A	60	1527930000
ZQV 4N/10	32 A	20	1528090000
WAP WDU/WTR4/ZR		50	1905070000
WEW 35/2		100	1061200000
DEK 5/6 MC NE WS		1000	1609820000
WS 12/6 MC NE WS		600	1609900000
WS 8/6 MM WS		600	2007160000
DEK 5/6 MM WS		600	2007120000

For detailed information on other accessories and application in the online catalogue

Cross-connections, see section "W series accessories".

WDU 4N

4 mm²

Compact design



6.1 x 44 x 37.7	
39 / 6	
0.13...6	

IEC 60947-7-1	Ex e II		II 2 G D
IEC	UL	CSA	EN 60079-7
500	300	300	440
32	10	10	31
4	AWG 26...10	AWG 26...10	4 mm ²
6 kV / 3			
A4 / V-0			
CE TÜV04ATEX2630U			
Rated connection	Further connection		
0.5...6 / 1.5...6	0.5...6 / 1.5...6		
0.5...4 / 0.5...4	0.5...4 / 0.5...4		
0.5...1 Nm / (M 3)			
11 / 0.6 x 3.5 mm			
0.5...1.5			

Type	Qty.	Order No.
WDU 4N	100	1042600000
WDU 4N BL	100	1042680000

Type	current	Qty.	Order No.
ZQV 4N/2	32 A	60	1527930000
ZQV 4N/10	32 A	20	1528090000
WAP WDU2.5N/4N		50	1060000000
WAP WDU2.5N/4N BL		50	1060080000
WEW 35/2		100	1061200000
WTA 1 WDU1.5		25	1632290000
WTA 1/ZA WDU1.5		25	1632300000
WAD 4 GE BED		50	1072000000
WAD 4 WS		50	1072100000
DEK 5/6 MC NE WS		1000	1609820000
WS 12/6 MC NE WS		600	1609900000
WS 8/6 MM WS		600	2007160000
DEK 5/6 MM WS		600	2007120000

Cross-connections, see section "W series accessories".

WDU 4 SL

4 mm²

WDU 4 SL/EN

4 mm²

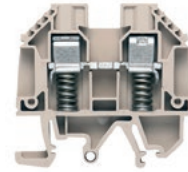
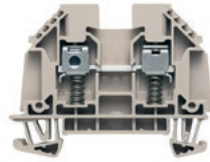

Width/Height/Depth	mm
max. current / max. cond. cross-section	A/mm ²
Max. clamping range	mm ²

6.1 x 60 x 46.5
41 / 6
0.22...6

6.1 x 60 x 51.5
41 / 6
0.22...6

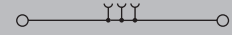

Technical data

Rated data	
Rated voltage	V
Rated current	A
for wire cross-section	mm ²
Rated impulse withstand voltage / Pollution severity	
Gauge to IEC 60947-1 / UL 94 flammability rating	
Approvals	
Clamped conductors (H05V/H07V)	
Solid / Stranded	mm ²
Flexible / Flexible with ferrule	mm ²
Tightening torque (clamping screw for copper conductors)	-
Stripping length / Blade size	mm/-
2 conductors with same cross-section (H05V/H07V)	
Solid / Stranded	mm ²
Flexible / Flexible with ferrule	mm ²
Note	

IEC 60947-7-1	Ex e II	Ex	II 2 G D
IEC	UL	CSA	EN 60079-7
630	600	300	440
32	30	25	32
4	AWG 22...10	AWG 22...10	4 mm ²
6 kV / 2			
A4 / V-0			
CE ENEC UL DEMKO14ATEX1338U			
Rated connection		Further connection	
0.5...6 / 1.5...6			
0.5...4 / 0.5...4			
0.5...1 Nm / (M 3)			
15 / 0.6 x 3.5 mm			
0.5...1.5			
0.5...1.5 / 0.5...1.5			
Note			
Note the max. current of the terminal (41 A) when using the cross-connector!			

IEC 60947-7-1	Ex e II	Ex	II 2 G D
IEC	UL	CSA	EN 60079-7
630	600	300	690
32	30	25	32
4	AWG 22...10	AWG 22...10	4 mm ²
6 kV / 2			
A4 / V-0			
CE ENEC UL DEMKO14ATEX1338U			
Rated connection		Further connection	
0.5...6 / 1.5...6			
0.5...4 / 0.5...4			
0.5...1 Nm / (M 3)			
15 / 0.6 x 3.5 mm			
0.5...1.5			
0.5...1.5 / 0.5...1.5			
Note			
Note the max. current of the terminal (41 A) when using the cross-connector!			

Ordering data

Version	
	dark beige
	dark beige
	blue
Note	

Type	Qty.	Order No.
WDU 4 SL	50	9537440000
WDU 4 SL BL	50	9203060000
Note		
With pollution severity degree 2, the voltage can be raised to 630 V (no increased contamination can appear).		

Type	Qty.	Order No.
WDU 4 SL/EN	50	9537450000
Note		
With pollution severity degree 2, the voltage can be raised to 630 V (no increased contamination can appear).		

Accessories

Screwable cross-connection	
	2-pole
	10-pole
End plate / Partition plate	
	dark beige
	Blue
	dark beige
	Blue
End bracket	
	dark beige
Testing / Checking	
	Standard
Cover	
	Blank, yellow
	Blank, white
Identification systems	
Pluggable cross-connection	
	2-pole
	10-pole
Hak. Cable lugs	
	HBT 1,5 - 3,0 RT
	HBT 2,5 - 3,0 BL
For detailed information on other accessories and application in the online catalogue	

Type	current	Qty.	Order No.
WQV 4/2	32 A	50	1051960000
WQV 4/10	41 A	20	1052060000
WAP 2.5-10		50	1050000000
WAP 16+35 WTW 2.5-10		20	1050100000
WEW 35/2		100	1061200000
WTA 3 WDU4		25	1632350000
WS 12/6 MC NE WS		600	1609900000
ZQV 4N/2	32 A	60	1527930000
ZQV 4N/10	32 A	20	1528090000
HBT 1,5 - 3,0 RT		100	1312440000
HBT 2,5 - 3,0 BL		100	1312450000
Note			
Cross-connections, see section "W series accessories".			

Type	current	Qty.	Order No.
WQV 4/2	32 A	50	1051960000
WQV 4/10	41 A	20	1052060000
WAP 2.5-10		50	1050000000
WAP 16+35 WTW 2.5-10		20	1050100000
WEW 35/2		100	1061200000
WTA 3 WDU4		25	1632350000
WS 12/6 MC NE WS		600	1609900000
ZQV 4N/2	32 A	60	1527930000
ZQV 4N/10	32 A	20	1528090000
HBT 1,5 - 3,0 RT		100	1312440000
HBT 2,5 - 3,0 BL		100	1312450000
Note			
Cross-connections, socket and test plug, see section "W series accessories". Only 400 V with the use of shield bus LS 2.8 1056400000.			

Screw connection with clamping yoke technology (W-Series)

Feed-through terminal blocks

Universal range

A

WDU 6

6 mm²

WDU 6 HV

6 mm²

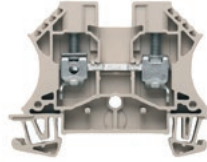

Width/Height/Depth	mm
max. current / max. cond. cross-section	A/mm ²
Max. clamping range	mm ²

7.9 x 60 x 46.5
57 / 10
0.22...10

7.9 x 60 x 46.5
57 / 10
0.22...10

Technical data

Rated data	
Rated voltage	V
Rated current	A
for wire cross-section	mm ²
Rated impulse withstand voltage / Pollution severity	
Gauge to IEC 60947-1 / UL 94 flammability rating	
Approvals	
Clamped conductors (H05V/H07V)	
Solid / Stranded	mm ²
Flexible / Flexible with ferrule	mm ²
Tightening torque (clamping screw for copper conductors)	-
Stripping length / Blade size	mm/-
2 conductors with same cross-section (H05V/H07V)	
Solid / Stranded	mm ²
Flexible / Flexible with ferrule	mm ²
Note	

IEC 60947-7-1	Ex e II	II 2 G D	
IEC	UL	CSA	EN 60079-7
800	600	600	690
41	50	50	41
6	AWG 22...8	AWG 22...8	6 mm ²
8 kV / 3			
A5 / V-0			
CE DEMKO14ATEX1338U			
Rated connection	Further connection		
0.5...10 / 1.5...10			
0.5...10 / 0.5...6			
0.8...1.6 Nm / (M 3.5)			
12 / 0.8 x 4.0 mm			
0.5...2.5			
0.5...2.5 / 0.5...2.5			
<small>Note max. current of terminal (57 A) when using WQV Wire connection H07V...10 and AWG 8 with tightening torque of 1.4-1.6 Nm.</small>			

IEC 60947-7-1			
IEC	UL	CSA	EN 60079-7
1000			
41			
6			
8 kV / 3			
A5 / V-0			
Rated connection	Further connection		
0.5...10 / 1.5...10			
0.5...10 / 0.5...6			
0.8...1.6 Nm / (M 3.5)			
12 / 0.8 x 4.0 mm			
0.5...2.5 / 0.5...2.5			

Ordering data

Version	
	dark beige
	dark beige
	blue
Note	

Type	Qty.	Order No.
WDU 6	100	1020200000
WDU 6 BL	100	1020280000
<small>1000 VDC rated voltage tested. For colour versions, see section on W-series Accessories - specific functions.</small>		

Type	Qty.	Order No.
WDU 6 HV	100	1412970000
WDU 6 IR	100	1393350000

Accessories

Screwable cross-connection	
	2-pole
	10-pole
End plate / Partition plate	
	dark beige
	Blue
	dark beige
	Blue
End bracket	dark beige
Testing / Checking	
	Standard
Cover	
	Blank, yellow
	Blank, white
Identification systems	
Pluggable cross-connection	
	2-pole
	10-pole
Hak. Cable lugs	
For detailed information on other accessories and application in the online catalogue	

Type	current	Qty.	Order No.
WQV 6/2	57 A	50	1052360000
WQV 6/10	57 A	20	1052260000
WAP 2.5-10		50	1050000000
WAP 2.5-10 BL		50	1050080000
WAP 16+35 WTW 2.5-10		20	1050100000
WAP 16+35 WTW 2.5-10 BL		20	1050180000
WEW 35/2		100	1061200000
WTA 3 WDU4		25	1632350000
WAD 8 MC NE GE		48	1112950000
WAD 8 MC NE WS		48	1112940000
DEK 5/8 MC NE WS		800	1856740000
WS 12/6.5 MC NE WS		540	1609920000
WS 8/8 MM WS		500	2007170000
DEK 5/8 MM WS		500	2007130000

Type	current	Qty.	Order No.
WQV 6/2	57 A	50	1052360000
WQV 6/10	57 A	20	1052260000
WAP 2.5-10		50	1050000000
WAP 2.5-10 BL		50	1050080000
WAP 16+35 WTW 2.5-10		20	1050100000
WAP 16+35 WTW 2.5-10 BL		20	1050180000
WEW 35/2		100	1061200000
WTA 3 WDU4		25	1632350000
WAD 8 MC NE GE		48	1112950000
WAD 8 MC NE WS		48	1112940000
DEK 5/8 MC NE WS		800	1856740000
WS 12/8 PLUS MC NE WS		420	1906000000
WS 8/8 MM WS		500	2007170000
DEK 5/8 MM WS		500	2007130000

Cross-connections, socket and test plug, see section "W series accessories". Only 400 V with the use of shield bus LS 2.8 1056400000.

WDU 6 SL

6 mm²

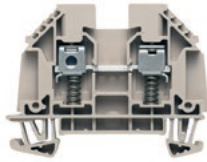

7.9 x 60 x 46.5
57 / 6
0.5...6



IEC 60947-7-1 Ex e II II 2 G D

IEC	UL	CSA	EN 60079-7
630	150	300	275
41	50	45	40
6	AWG 20...8	AWG 20...8	6 mm ²
6 kV / 2			
A5 / V-0			

CE DEMKO14ATEX1338U

Rated connection	Further connection
0.5...6 6	
0.5...6	
0.8...1.6 Nm / (M 3.5)	
16 / 0.8 x 4.0 mm	
0.5	

ESI rated data: 500 V/24 A / Note the max. current of the terminal (57 A) when using the cross-connector!

Type	Qty.	Order No.
WDU 6 SL	50	9537460000

With pollution severity degree 2, the voltage can be raised to 630 V (no increased contamination can appear).

Type	current	Qty.	Order No.
WQV 6/2	57 A	50	1052360000
WQV 6/10	57 A	20	1052260000
WAP 2.5-10		50	1050000000
WAP 16+35 WTW 2.5-10		20	1050100000
WEW 35/2		100	1061200000
WTA 5/1		25	1051260000
DEK 5/8 MC NE WS		800	1856740000
WS 12/6.5 MC NE WS		540	1609920000
WS 8/8 MM WS		500	2007170000
DEK 5/8 MM WS		500	2007130000
HBT 1,5 - 4,6 RT		100	1233340000
HBT 2,5 - 4,6 BL		100	1233330000
HBT 6,0 - 4,6 GE		100	1216230000

Cross-connections, see section "W series accessories".

WDU 6 SL/EN

6 mm²



7.9 x 60 x 51.1
57 / 6
0.5...6

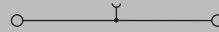

IEC 60947-7-1 Ex e II II 2 G D

IEC	UL	CSA	EN 60079-7
630	150	300	440
41	50	45	40
6	AWG 20...8	AWG 20...8	6 mm ²
6 kV / 2			
A5 / V-0			

CE DEMKO14ATEX1338U

Rated connection	Further connection
0.5...6 6	
0.5...6	
0.8...1.6 Nm / (M 3.5)	
16 / 0.8 x 4.0 mm	
0.5	

ESI rated data: 500 V/24 A / Note the max. current of the terminal (57 A) when using the cross-connector!

Type	Qty.	Order No.
WDU 6 SL/EN	50	9537470000

With pollution severity degree 2, the voltage can be raised to 630 V (no increased contamination can appear).

Type	current	Qty.	Order No.
WQV 6/2	57 A	50	1052360000
WQV 6/10	57 A	20	1052260000
WAP 2.5-10		50	1050000000
WAP 16+35 WTW 2.5-10		20	1050100000
WEW 35/2		100	1061200000
WTA 5/1		25	1051260000
DEK 5/8 MC NE WS		800	1856740000
WS 12/6.5 MC NE WS		540	1609920000
WS 8/8 MM WS		500	2007170000
DEK 5/8 MM WS		500	2007130000
HBT 1,5 - 4,6 RT		100	1233340000
HBT 2,5 - 4,6 BL		100	1233330000
HBT 6,0 - 4,6 GE		100	1216230000

Cross-connections, see section "W series accessories".



Screw connection with clamping yoke technology (W-Series)

Feed-through terminal blocks

WDU 10

10 mm²

WDU 10 IR

10 mm²

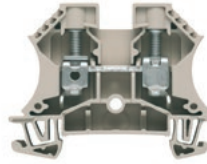

Width/Height/Depth	mm
max. current / max. cond. cross-section	A/mm ²
Max. clamping range	mm ²

9.9 x 60 x 46.5
76 / 16
1.31...16

9.9 x 60 x 46.5
76 / 16
1.31...16

Technical data

Rated data	
Rated voltage	V
Rated current	A
for wire cross-section	mm ²
Rated impulse withstand voltage / Pollution severity	
Gauge to IEC 60947-1 / UL 94 flammability rating	
Approvals	
Clamped conductors (H05V/H07V)	
Solid / Stranded	mm ²
Flexible / Flexible with ferrule	mm ²
Tightening torque (clamping screw for copper conductors)	-
Stripping length / Blade size	mm/-
2 conductors with same cross-section (H05V/H07V)	
Solid / Stranded	mm ²
Flexible / Flexible with ferrule	mm ²
Note	

IEC 60947-7-1	Ex e II	Ex	II 2 G D
IEC	UL	CSA	EN 60079-7
1000	600	600	690
57	65	65	57
10	AWG 18...6	AWG 18...6	10 mm ²
8 kV / 3			
B6 / V-0			
CE CB IEC KEMA ATEX NF			
DEMKO14ATEX1338U			
Rated connection		Further connection	
1.5...16 / 1.5...16			
1.5...16 / 1.5...16			
1.2...1.9 Nm / (M 4)			
12 / 1.0 x 5.5 mm			
1.5...6 / 0.5...6			
0.5...6 / 0.5...6			
Note max. current of terminal (76 A) when using WQV! Tighten AWG 6/7 and H07V-R16 to 2.4 Nm.			

IEC 60947-7-1	Ex e II	Ex	II 2 G D
IEC	UL	CSA	EN 60079-7
1000			
57			
10			
8 kV / 3			
B6 / V-0			
Rated connection		Further connection	
1.5...16 / 1.5...16			
1.5...16 / 1.5...16			
1.5...1.8 Nm / (M 4)			
12 / TX 15			

Ordering data

Version	
	dark beige
	blue
	black (combi clip-on feet TS 32/25)
Note	

Type	Qty.	Order No.
WDU 10	50	1020300000
WDU 10 BL	50	1020380000
1000 VDC rated voltage tested. For alternative colours, see section on W-series accessories – specific functions.		

Type	Qty.	Order No.
WDU 10 IR	50	1393380000

Accessories

Screwable cross-connection	
	2-pole
	10-pole
End plate / Partition plate	
	dark beige
	Blue
	dark beige
	Blue
End bracket	
	dark beige
Testing / Checking	
	Standard
Cover	
	Blank, yellow
	Blank, white
Identification systems	
Hak. Cable lugs	

Type	current	Qty.	Order No.
WQV 10/2	57 A	50	1052560000
WQV 10/10	57 A	20	1052460000
WAP 2.5-10		50	1050000000
WAP 2.5-10 BL		50	1050080000
WAP 16+35 WTW 2.5-10		20	1050100000
WAP 16+35 WTW 2.5-10 BL		20	1050180000
WEW 35/2		100	1061200000
WTA 3 WDU4		25	1632350000
WAD 8 MC NE GE		48	1112950000
WAD 8 MC NE WS		48	1112940000
DEK 5/5 MC NE WS		1000	1609801044
WS 12/6.5 MC NE WS		540	1609920000

Type	current	Qty.	Order No.
WQV 10/2	57 A	50	1052560000
WQV 10/10	57 A	20	1052460000
WAP 2.5-10		50	1050000000
WAP 2.5-10 BL		50	1050080000
WAP 16+35 WTW 2.5-10		20	1050100000
WAP 16+35 WTW 2.5-10 BL		20	1050180000
WEW 35/2		100	1061200000
WTA 5/1		25	1051260000
WAD 8 MC NE GE		48	1112950000
WAD 8 MC NE WS		48	1112940000
DEK 5/5 MC NE WS		1000	1609801044
WS 12/6.5 MC NE WS		540	1609920000

For detailed information on other accessories and application in the online catalogue

Cross-connections, socket and test plug, see section "W series accessories". Only 400 V with the use of shield bus LS 2.8 1056400000.

WDU 10/ZR

10 mm²

Additional connection on right 4 mm²

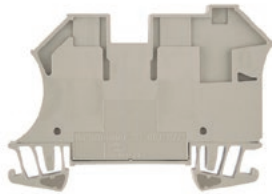

9.9 x 70 x 49
76 / 16
1.31...16



IEC 60947-7-1

IEC	UL	CSA	EN 60079-7
800	600	600	
57	65	65	
10	AWG 16...6	AWG 16...6	
8 kV / 3 B6, A4 / V-0			

CE ENEC IEC

Rated connection	Further connection
1.5...16 / 1.5...16	0.5...6 / 1.5...4
1.5...16 / 1.5...16	0.5...4 / 0.5...4
1.2...1.9 Nm / (M 4)	
12 / 0.6 x 3.5 mm	10 / 0.6 x 3.5 mm
1.5...6	
1...6 / 1...6	
Note max. current of terminal (76 A) when using WQV1 Tighten AWG 6/7 and H07V-R16 to 2.4 Nm. Upper right ZR connection A 4.	

Type	Qty.	Order No.
WDU 10/ZR	50	1042400000
WDU 10/ZR BL	50	1042480000
The measurement data relates to the 10 mm ² connection.		

Type	current	Qty.	Order No.
WQV 10/2	57 A	50	1052560000
WQV 10/10	57 A	20	1052460000
WEW 35/2		100	1061200000
WTA 5/1		25	1051260000
DEK 5/5 MC NE WS		1000	1609801044
WS 12/6.5 MC NE WS		540	1609920000
HBT 1,5 - 4,6 RT		100	1233340000
HBT 2,5 - 4,6 BL		100	1233330000
HBT 6,0 - 4,6 GE		100	1216230000

Cross-connections, socket and test plug, see section "W series accessories".

WDU 10 SL

10 mm²

9.9 x 60 x 46.25
76 / 10
1.31...10

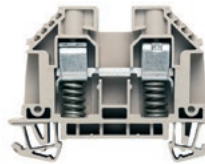

IEC 60947-7-1

IEC	UL	CSA	EN 60079-7
630	150	300	352
57	50	65	55
10	AWG 16...8	AWG 16...6	10 mm ²
6 kV / 2 A5 / V-0			

CE ENEC IEC

Rated connection	Further connection
1.5...10 / 1.5...10	
1...6 / 1.5...10	
1.2...2.4 Nm / (M 4)	
17 / 1.0 x 5.5 mm	
1.5...4	
2.5...4 / 1...4	
ESI rated data: 500 V/36 A / 16 mm ² stranded connection must be tightened with 2 Nm.	

Type	Qty.	Order No.
WDU 10 SL	50	9537480000
With pollution severity degree 2, the voltage can be raised to 630 V (no increased contamination can appear).		

Type	current	Qty.	Order No.
WQV 10/2	57 A	50	1052560000
WQV 10/10	57 A	20	1052460000
WAP 2.5-10		50	1050000000
WAP 2.5-10 BL		50	1050080000
WAP 16+35 WTW 2.5-10		20	1050100000
WEW 35/2		100	1061200000
WTA 5/1		25	1051260000
DEK 5/5 MC NE WS		1000	1609801044
WS 12/6.5 MC NE WS		540	1609920000
HBT 1,5 - 4,6 RT		100	1233340000
HBT 2,5 - 4,6 BL		100	1233330000
HBT 6,0 - 4,6 GE		100	1216230000

Cross-connections, see section "W series accessories".

WDU 10 SL/EN

10 mm²

9.9 x 56.6 x 51.1
76 / 16
1.31...16

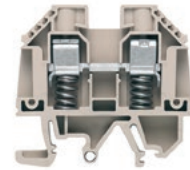

IEC 60947-7-1

IEC	UL	CSA	EN 60079-7
630	600	300	550
57	50	65	55
10	AWG 16...8	AWG 16...6	10 mm ²
6 kV / 2 A6 / V-0			

CE ENEC IEC

Rated connection	Further connection
1.5...16 / 1.5...16	
1...6 / 1.5...10	
1.2...2.4 Nm / (M 4)	
17 / 1.0 x 5.5 mm	
1.5...4	
2.5...4 / 1...4	
ESI rated data: 500 V/36 A / 16 mm ² stranded connection must be tightened with 2 Nm.	

Type	Qty.	Order No.
WDU 10 SL/EN	50	9537490000
With pollution severity degree 2, the voltage can be raised to 630 V (no increased contamination can appear).		

Type	current	Qty.	Order No.
WQV 10/2	57 A	50	1052560000
WQV 10/10	57 A	20	1052460000
WAP 2.5-10		50	1050000000
WAP 2.5-10 BL		50	1050080000
WAP 16+35 WTW 2.5-10		20	1050100000
WEW 35/2		100	1061200000
WTA 5/1		25	1051260000
DEK 5/5 MC NE WS		1000	1609801044
WS 12/6.5 MC NE WS		540	1609920000
HBT 1,5 - 4,6 RT		100	1233340000
HBT 2,5 - 4,6 BL		100	1233330000
HBT 6,0 - 4,6 GE		100	1216230000

Cross-connections, see section "W series accessories".



Screw connection with clamping yoke technology (W-Series)

Feed-through terminal blocks

WDU 16

16 mm²

With peg for higher connection stability

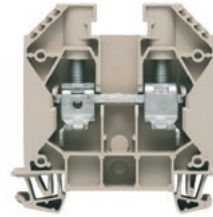

Width/Height/Depth	mm
max. current / max. cond. cross-section	A/mm ²
Max. clamping range	mm ²

11.9 x 60 x 62.5
101 / 25
0.82...25

Technical data

Rated data	
Rated voltage	V
Rated current	A
for wire cross-section	mm ²
Rated impulse withstand voltage / Pollution severity	
Gauge to IEC 60947-1 / UL 94 flammability rating	
Approvals	

IEC 60947-7-1 Ex e II II 2 G D

IEC	UL	CSA	EN 60079-7
1000	600	600	690
76	85	85	76
16	AWG 18...4	AWG 18...6	16 mm ²
8 kV / 3			
B7 / V-0			

Clamped conductors (H05V/H07V)	
Solid / Stranded	mm ²
Flexible / Flexible with ferrule	mm ²
Tightening torque (clamping screw for copper conductors)	-
Stripping length / Blade size	mm/-
2 conductors with same cross-section (H05V/H07V)	
Solid / Stranded	mm ²
Flexible / Flexible with ferrule	mm ²

CE DEMKO14ATEX1338U

Rated connection	Further connection
1.5...16 / 1.5...25	
1.5...25 / 1.5...16	
3...4 Nm / (M 5)	
16 / 1.0 x 5.5 mm	
1.5...4	
1.5...4 / 1.5...4	

Note

Conductor connection H07V...16 and AWG 6 with tightening torque of 2.0-2.4 Nm.

Ordering data

Version	
	dark beige
	blue
Note	

Type	Qty.	Order No.
WDU 16	50	1020400000
WDU 16 BL	50	1020480000

Order No. 1020400000 and 1020480000 (blue) versions without pegs (50 pcs.)

Accessories

Screwable cross-connection	
	2-pole
	10-pole
End plate / Partition plate	
	dark beige
	Blue
End bracket	
	dark beige
Cover	
	With lightning flash symbol
	Blank, white
Identification systems	

Type	current	Qty.	Order No.
WQV 16/2	76 A	50	1053260000
WQV 16/10	76 A	10	1053360000
WAP 16*35 WTW 2.5-10		20	1050100000
WAP 16*35 WTW 2.5-10 BL		20	1050180000
WEW 35/1		50	1059000000
WAD 12 MC B GE/SW		32	2445090000
WAD 12 MC NE WS		32	2445070000
DEK 5/5 MC NE WS		1000	1609801044
WS 12/6.5 MC NE WS		540	1609920000

For detailed information on other accessories and application in the online catalogue

Socket and test plug, see section "W-series accessories"

WDU 16 IR

16 mm²

WDU 16N

16 mm²

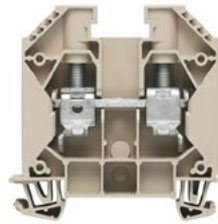

Width/Height/Depth	mm
max. current / max. cond. cross-section	A/mm ²
Max. clamping range	mm ²

11.9 x 60 x 62.5
101 / 25
0.82...25

12 x 60 x 46.5
101 / 25
1.5...25

Technical data

Rated data	
Rated voltage	V
Rated current	A
for wire cross-section	mm ²
Rated impulse withstand voltage / Pollution severity	
Gauge to IEC 60947-1 / UL 94 flammability rating	
Approvals	
Clamped conductors (H05V/H07V)	
Solid / Stranded	mm ²
Flexible / Flexible with ferrule	mm ²
Tightening torque (clamping screw for copper conductors)	-
Stripping length / Blade size	mm/-
2 conductors with same cross-section (H05V/H07V)	
Solid / Stranded	-
Flexible / Flexible with ferrule	-
Note	

IEC 60947-1	Ex e II	Ex	II 2 G D
IEC	UL	CSA	EN 60079-7
1000		690	
76		76	
16		16 mm ²	
	8 kV / 3		
	B7 / V-0		
IEC	DEMKO14ATEX1338U		
Rated connection	Further connection		
1.5...16 / 1.5...25			
1.5...25 / 1.5...16			
3...4 Nm / (M 5)			
16 / TX 15			
Note			

IEC 60947-1			
IEC	UL	CSA	EN 60079-7
690	600	300	
76	70	70	
16	AWG 14...6	AWG 14...6	
	8 kV / 3		
	B7 / V-0		
CE	IEC	UL	CSA
Rated connection	Further connection		
1.5...16 / 1.5...25			
1.5...16 / 1.5...16			
1.2...2.4 Nm / (M 4)			
12 / 1.0 x 5.5 mm			
1.5..4			
1.5..4 / 1.5..4			
Note			
AWG 6/7 and H07V-R25 tighten with a tightening torque of 1.5 Nm.			

Ordering data

Version	dark beige dark beige blue
Note	

Type	Qty.	Order No.
WDU 16 IR	50	1393390000
Note		

Type	Qty.	Order No.
WDU 16N	50	1036100000
WDU 16N BL	50	1036180000
Note		
1000 VDC rated voltage tested.		

Accessories

Screwable cross-connection	
	2-pole 4-pole 10-pole
End plate / Partition plate	
	dark beige Blue
End bracket	
	dark beige
Testing / Checking	
	Standard
Cover	
	With lightning flash symbol Blank, white
Additional connection	
	4 mm ²
Identification systems	

Type	current	Qty.	Order No.
WQV 16/2	76 A	50	1053260000
WQV 16/10	76 A	10	1053360000
WAP 16*35 WTW 2.5-10		20	1050100000
WAP 16*35 WTW 2.5-10 BL		20	1050180000
WEW 35/1		50	1059000000
WAD 12 M.BL.		50	1055960000
WAD 12 NEUTRAL		50	1056260000
DEK 5/5 MC NE WS		1000	1609801044
WS 12/5 MC NE WS		720	1609860000

Type	current	Qty.	Order No.
WQV 16N/2	76 A	50	1636560000
WQV 16N/4	76 A	50	1636580000
WTW EN		20	1058800000
WEW 35/2		100	1061200000
WTA 2 WDU2.5-10		25	1632320000
WAD 12N GE BED		50	1073200000
WAD 12N WS		50	1073290000
DEK 5/5 MC NE WS		1000	1609801044
WS 10/12 MC NE WS		300	1905970000

For detailed information on other accessories and application in the online catalogue

Cross-connections, socket and test plug, see section "W series accessories".



Screw connection with clamping yoke technology (W-Series)

Feed-through terminal blocks

Universal range

A

WDU 35

35 mm²

Clamping screw / spigot for good connection stability

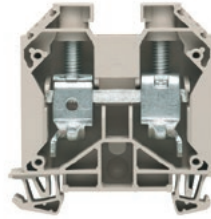

WDU 35 IR

35 mm²

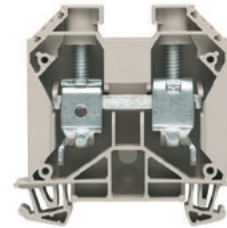

Width/Height/Depth	mm
max. current / max. cond. cross-section	A/mm ²
Max. clamping range	mm ²

16 x 60 x 62.5
150 / 50
2.5...50

16 x 60 x 62.5
150 / 50
2.5...50

Technical data

Rated data	
Rated voltage	V
Rated current	A
for wire cross-section	mm ²
Rated impulse withstand voltage / Pollution severity	
Gauge to IEC 60947-1 / UL 94 flammability rating	
Approvals	
Clamped conductors (H05V/H07V)	
Solid / Stranded	mm ²
Flexible / Flexible with ferrule	mm ²
Tightening torque (clamping screw for copper conductors)	-
Stripping length / Blade size	mm/-
2 conductors with same cross-section (H05V/H07V)	
Solid / Stranded	mm ²
Flexible / Flexible with ferrule	mm ²
Note	

IEC 60947-1	Ex e II	Ex	II 2 G D
IEC	UL	CSA	EN 60079-7
1000	1000	600	690
125	150	150	115
35	AWG 12...0	AWG 12...2	35 mm ²
8 kV / 3			
B8 / V-0			
CE CB IEC KEMA GOST TUV SUD DEMKO14ATEX1338U			
Rated connection	Further connection		
2.5...16 / 2.5...50			
2.5...35 / 2.5...35			
4...5 Nm / (M 6)			
18 / 6.5 x 1.2 mm			
Rated connection	Further connection		
2.5...10 / 16...16			
2.5...16 / 2.5...16			

IEC 60947-1	Ex e II	Ex	II 2 G D
IEC	UL	CSA	EN 60079-7
1000			690
125			115
35			35 mm ²
8 kV / 3			
B8 / V-0			
DEMKO14ATEX1338U			
Rated connection	Further connection		
2.5...16 / 2.5...50			
2.5...35 / 2.5...35			
4...5 Nm / (M 6)			
18 / TX 20			
Rated connection	Further connection		

Ordering data

Version	
	dark beige
	dark beige
	blue
Note	

Type	Qty.	Order No.
WDU 35	40	1020500000
WDU 35 BL	40	1020580000
Order No. 1020500000 and 1020580000 (blue) versions without pegs (40 pcs.).		

Type	Qty.	Order No.
WDU 35 IR	40	1393400000

Accessories

Screwable cross-connection	
	2-pole
	4-pole
	10-pole
End plate / Partition plate	
	dark beige
	Blue
End bracket	
	dark beige
Testing / Checking	
	Standard
Cover	
	With lightning flash symbol
	Blank, white
Additional connection	
	4 mm ²
Identification systems	

Type	current	Qty.	Order No.
WQV 35/2	135 A	50	1053060000
WQV 35/10	112 A	10	1053160000
WAP 16+35 WTW 2.5-10		20	1050100000
WAP 16+35 WTW 2.5-10 BL		20	1050180000
WEW 35/1		50	1059000000
WAD 12 M.BL.		50	1055960000
WAD 12 NEUTRAL		50	1056260000
DEK 5/5 MC NE WS		1000	1609801044
WS 12/6.5 MC NE WS		540	1609920000

Type	current	Qty.	Order No.
WQV 35/2	135 A	50	1053060000
WQV 35/10	112 A	10	1053160000
WAP 16+35 WTW 2.5-10		20	1050100000
WAP 16+35 WTW 2.5-10 BL		20	1050180000
WEW 35/1		50	1059000000
WAD 12 M.BL.		50	1055960000
WAD 12 NEUTRAL		50	1056260000
DEK 5/5 MC NE WS		1000	1609801044
WS 12/5 MC NE WS		720	1609860000

For detailed information on other accessories and application in the online catalogue

Cross-connections, socket and test plug, see section "W series accessories".

WDU 35 IK

35 mm²

Hexagonal socket / spigot for good connection stability

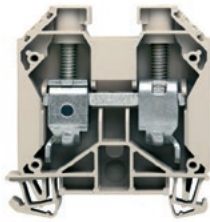

16 x 60 x 62.5
150 / 50
2.5...50

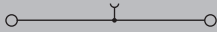

IEC 60947-7-1 Ex e II II 2 G D

IEC	UL	CSA	EN 60079-7
1000	600	600	690
125	150	150	115
35	AWG 12...NaN	AWG 12...1	35 mm ²

8 kV / 3
B8 / V-0

DEMKO14ATEX1338U

Rated connection	Further connection
2.5...16 / 2.5...50	
2.5...35 / 2.5...35	
4...6 Nm / (M 6)	
18 / S4 (DIN 6911)	
2.5...10 / 16...16	
2.5...16 / 2.5...16	

Type	Qty.	Order No.
WDU 35/IK	25	1020600000
WDU 35/IK/ZA	25	1029000000
WDU 35/IK BL	25	1020680000

Order No. 1020600000 and 1020680000 (blue) versions without pegs (25 pcs.).

Type	current	Qty.	Order No.
WQV 35/2	135 A	50	1053060000
WQV 35/10	112 A	10	1053160000
WAP 16+35 WTW 2.5-10		20	1050100000
WAP 16+35 WTW 2.5-10 BL		20	1050180000
WEW 35/1		50	1059000000
WAD 12 M.BL		50	1055960000
WAD 12 NEUTRAL		50	1056260000
DEK 5/5 MC NE WS		1000	1609801044
WS 12/6.5 MC NE WS		540	1609920000

Cross-connections, socket and test plug, see section "W series accessories".

WDU 35N

35 mm²

Suitable for power distribution
Compact design



16 x 66 x 50.5
150 / 50
2.5...50

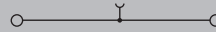

IEC 60947-7-1 Ex e II II 2 G D

IEC	UL	CSA	EN 60079-7
500	1000	600	352
125	150	150	110
35	AWG 12...0	AWG 12...2	35 mm ²

6 kV / 3
B8 / V-0

DEMKO14ATEX1338U

Rated connection	Further connection
2.5...16 / 2.5...50	
2.5...35 / 2.5...35	
4...5 Nm / (M 6)	
18 / 6.5 x 1.2 mm	
2.5...6	
2.5...6 / 2.5...6	

1000 V DC rated voltage tested.

Type	Qty.	Order No.
WDU 35N	20	1040400000
WDU 35N BL	20	1040480000

1000 V UL and CSA for usage groups B and C: can be used with isolating DIN rails and when using WTW-EN partitions.

Type	current	Qty.	Order No.
WQV 35N/2	135 A	20	1079200000
WQV 35N/4	101 A	20	1079400000
WTW EN		20	1058800000
WEW 35/2		100	1061200000
WAD 16N GE BED		50	1083600000
DEK 5/5 MC NE WS		1000	1609801044
WS 12/6.5 MC NE WS		540	1609920000

Cross-connections, see section "W series accessories".



Screw connection with clamping yoke technology (W-Series)
Feed-through terminal blocks

Universal range

A

WDU 50N

50 mm²

Compact design



Width/Height/Depth	mm
max. current / max. cond. cross-section	A/mm ²
Max. clamping range	mm ²

18.5 x 70 x 69.6
192 / 70
10...70

Technical data

Rated data	
Rated voltage	V
Rated current	A
for wire cross-section	mm ²
Rated impulse withstand voltage / Pollution severity	
Gauge to IEC 60947-1 / UL 94 flammability rating	
Approvals	
Clamped conductors (H05V/H07V)	
Solid / Stranded	mm ²
Flexible / Flexible with ferrule	mm ²
Tightening torque (clamping screw for copper conductors)	-
Stripping length / Blade size	mm/-
2 conductors with same cross-section (H05V/H07V)	
Solid / Stranded	-
Flexible / Flexible with ferrule	mm ²
Note	

IEC 60947-7-1	Ex e II	Ex	II 2 G D
IEC	UL	CSA	EN 60079-7
1000	600	600	690
150	150	150	126
50	AWG 10...0	AWG 8...0	50 mm ²
8 kV / 3			
B10 / V-0			
CE ENEC UL RUL DEMKO14ATEX1338U			
Rated connection	Further connection		
6...16 / 6...70			
10...50 / 6...50			
3.5...6 Nm / (M 6)			
24 / S4 (DIN 6911)			
...16 / 6...16			
6...16 / 6...16			
1000 V DC rated voltage tested.			

Ordering data

Version	
	dark beige
	blue
Note	

Type	Qty.	Order No.
WDU 50N	10	1820840000
WDU 50N BL	10	1820850000
1000 V UL and CSA for usage groups B and C: can be used with isolating DIN rails and when using WTW-EN partitions.		

Accessories

Screwable cross-connection	
	2-pole
	3-pole
	4-pole
End bracket	
	dark beige
Cover	
	With lightning flash symbol
Additional connection	
	10 mm ²
Identification systems	
Screwdriver	
	Standard

Type	current	Qty.	Order No.
WQV 50N/2	150 A	5	1834060000
WQV 50N/3	150 A	5	1834070000
WQV 50N/4	150 A	5	1834080000
WEW 35/1		50	1059000000
WAD 20 GE WSD		10	9512260000
WZAD 50N		5	1872720000
DEK 5/5 MC NE WS		1000	1609801044
WS 12/6.5 MC NE WS		540	1609920000
SKS 2,0-8,0 MR		1	9008870000

For detailed information on other accessories and application in the online catalogue

Auxiliary connection for additional conductor "WZAD 50N" 1872720000 (up to 10 mm², 41 A). Cross-connections, see section "W series accessories".

WDU 50N IR

50 mm²

Six-lobe socket



18.5 x 70 x 69.6
192 / 70
10...70

IEC 60947-7-1	Ex e II	Ex	II 2 G D
IEC	UL	CSA	EN 60079-7
1000			690
150			126
50			50 mm ²
8 kV / 3			
B10 / V-0			
CE ENEC UL RUL DEMKO14ATEX1338U			
Rated connection	Further connection		
10...16 / 10...70			
10...50 / 10...50			
3...6 Nm / (M 6)			
24 / TX 20			
...16 / 6...16			
6...16 / 6...16			
1000 V DC rated voltage tested.			

Type	Qty.	Order No.
WDU 50N IR	10	1186630000
1000 V UL and CSA for usage groups B and C: can be used with isolating DIN rails and when using WTW-EN partitions.		

Type	current	Qty.	Order No.
WQV 50N/2	150 A	5	1834060000
WQV 50N/3	150 A	5	1834070000
WQV 50N/4	150 A	5	1834080000
WEW 35/1		50	1059000000
WAD 20 GE WSD		10	9512260000
WZAD 50N		5	1872720000
DEK 5/5 MC NE WS		1000	1609801044
WS 12/6.5 MC NE WS		540	1609920000
TH-S 9-40		1	9008880000

Cross-connections, see section "W series accessories".

WDU 70N

70 mm²

Compact design

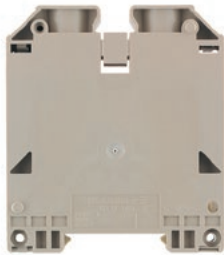

20.5 x 75 x 85
232 / 95
16...95



IEC 60947-7-1 Ex e II II 2 G D

IEC	UL	CSA	EN 60079-7
1000	600	600	690
192	150	150	184
70	AWG 6...0	AWG 6...0	70 mm ²

8 kV / 3
B11 / V-0

DEMKO14ATEX1338U

Rated connection	Further connection
16...16 / 16...95	
16...70 / 16...70	
8...12 Nm / (M 8)	
22 / S6 (DIN 6911)	
10...16 / 10...25	
10...25 / 6...25	
1000 V DC rated voltage tested.	

Type	Qty.	Order No.
WDU 70N/35	10	9512190000
WDU 70N/35 BL	10	9512420000

1000 V UL and CSA for usage groups B and C; can be used with isolating DIN rails and when using WTW-EN partitions.

Type	current	Qty.	Order No.
WQV 70N/2	192 A	5	9512240000
WQV 70N/3	192 A	5	9512250000
WQV 70N/4	192 A	5	9531290000
WEW 35/1		50	1059000000
WAD 20 GE WSD		10	9512260000
WZAD 70N		5	1964830000
DEK 5/5 MC NE WS	1000		1609801044
WS 12/6.5 MC NE WS	540		1609920000
SKS 2,0-8,0 MR		1	9008870000

Auxiliary connection for additional conductor "WZAD 70N" 1964830000 (up to 10 mm², 41 A). Cross-connections, see section "W series accessories".

WDU 70N/35 IR

70 mm²

Compact design

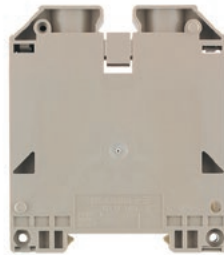

20.5 x 75 x 85
232 / 95
16...95

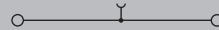

IEC 60947-7-1 Ex e II II 2 G D

IEC	UL	CSA	EN 60079-7
1000	600	600	690
192	150	150	184
70	AWG 6...0	AWG 6...0	70 mm ²

8 kV / 3
B11 / V-0

DEMKO14ATEX1338U

Rated connection	Further connection
16...16 / 16...95	
16...70 / 16...70	
8...12 Nm / (M 8)	
22 / TX 40	
10...16 / 10...25	
10...25 / 6...25	
1000 V DC rated voltage tested.	

Type	Qty.	Order No.
WDU 70N/35 IR	10	1393420000

Type	current	Qty.	Order No.
WQV 70N/2	192 A	5	9512240000
WQV 70N/3	192 A	5	9512250000
WQV 70N/4	192 A	5	9531290000
WEW 35/1		50	1059000000
WAD 20 GE WSD		10	9512260000
WZAD 70N		5	1964830000
DEK 5/5 MC NE WS	1000		1609801044
WS 12/5 MC NE WS	720		1609860000
TH-S 9-40		1	9008880000

Auxiliary connection for additional conductor "WZAD 70N" 1964830000 (up to 10 mm², 41 A). Cross-connections, see section "W series accessories".

WDU 95N/120N

120 mm²

Compact design



27 x 91 x 90
290 / 150
16...150



IEC 60947-7-1 Ex e II II 2 G D

IEC	UL	CSA	EN 60079-7
1000	1000	1000	880
269	228	220	221
120	AWG 4...250	AWG 4...0	120 mm ²

8 kV / 3
B13 / V-0

DEMKO14ATEX1338U

Rated connection	Further connection
16...16 / 16...150	
16...120 / 16...95	
12...20 Nm / (M 10)	
27 / S6 (DIN 6911)	
16...16 / 10...35	
16...35 / 10...35	
1000 V DC rated voltage tested.	

Type	Qty.	Order No.
WDU 95N/120N	5	1820550000
WDU 95N/120N BL	5	1820560000

1000 V UL and CSA for usage groups B and C; can be used with isolating DIN rails and when using WTW-EN partitions.

Type	current	Qty.	Order No.
WQV 95N/120N/2	269 A	5	1826890000
WQV 95N/120N/3	269 A	5	1826900000
WQV 95N/120N/4	269 A	5	1826910000
WEW 35/1		50	1059000000
WAD 20 GE WSD		10	9512260000
WZAD 95N/120N		5	1859580000
DEK 5/5 MC NE WS	1000		1609801044
WS 12/6.5 MC NE WS	540		1609920000
SKS 2,0-8,0 MR		1	9008870000

Auxiliary connection for additional conductor "WZAD 95N/120N" 1859580000 (up to 10 mm², 41 A). Cross-connections, see section "W series accessories".



Screw connection with clamping yoke technology (W-Series)

Feed-through terminal blocks

WDU 240

240 mm²



Width/Height/Depth	mm
max. current / max. cond. cross-section	A/mm ²
Max. clamping range	mm ²

36 x 100 x 123.7
415 / 240
70...240

Technical data

Rated data	
Rated voltage	V
Rated current	A
for wire cross-section	mm ²
Rated impulse withstand voltage / Pollution severity	
Gauge to IEC 60947-1 / UL 94 flammability rating	
Approvals	
Clamped conductors (H05V/H07V)	
Solid / Stranded	-
Flexible / Flexible with ferrule	mm ²
Tightening torque (clamping screw for copper conductors)	-
Stripping length / Blade size	mm/-
2 conductors with same cross-section (H05V/H07V)	
Solid / Stranded	-
Flexible / Flexible with ferrule	mm ²
Note	

IEC 60947-7-1	Ex e II		II 2 G D
IEC	UL	CSA	EN 60079-7
1000	600	600	1100
415	380	400	350
240		AWG 0...500	240 mm ²
8 kV / 3			
B15 / V-0			
CE		KEMA01ATEX2186U	
Rated connection	Further connection		
/ 70...240			
70...240 / 70...185			
25...30 Nm (M 10)			
40 / S8 (DIN 6911)			
/ 35...95			
50...95 / 35...50			
Copper straps can be used; see online catalogue for possible connections.			

Ordering data

Version	dark beige
	blue
Note	

Type	Qty.	Order No.
WDU 240	2	1802780000
WDU 240 BL	2	1822210000
1000 VDC rated voltage tested.		

Accessories

Screwable cross-connection	2-pole
	3-pole
	4-pole
End bracket	dark beige
Cover	With lightning flash symbol
	Blank, white
Additional connection	10 mm ²
Identification systems	
Screwdriver	Standard

Type	current	Qty.	Order No.
WQB 240/2	320 A	5	1802790000
WQB 240/3	320 A	5	1802800000
WEW 35/1		50	1059000000
WZAD 240		5	1802810000
DEK 5/5 MC NE WS		1000	1609801044
WS 12/6.5 MC NE WS		540	1609920000
SKS 2,0-8,0 MR		1	9008870000

For detailed information on other accessories and application in the online catalogue





Leaf clamp

Leaf clamp conductor connection for large cross-sections

It is no longer the case that conductors with large cross-sections have to be forced into the clamping point. Instead, they can now be easily laid in the modular terminal.

In addition to the individual form, every type of terminal can also be supplied in the form of 3-, 4- and 5-pole blocks. All the blocks are permanently screwed together and therefore guarantee additional rigidity. Direct mounting is possible thanks to the elongated holes on the underside of the terminals.

Terminal blocks can be screwed directly to mounting plates with a 25 mm pitch.

The other advantages are:

- Constant force transfer through selfadjusting connection system
- Mounting in any direction
- Electric shock protection (finger-proof) to German standard VBG 4, also with cross-connections
- Extremely resistant to distortion

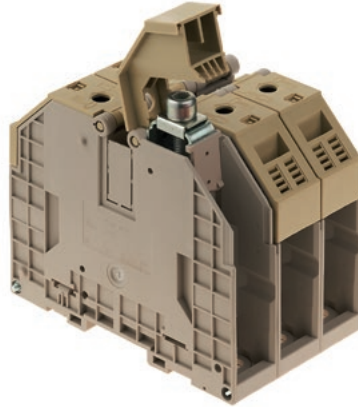

Open cover and remove
screw assembly

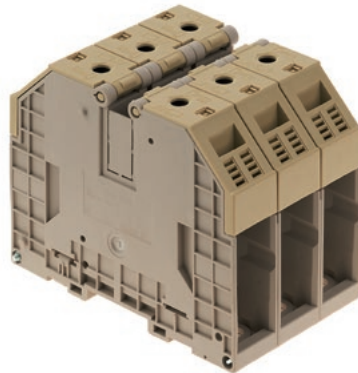

Close cover and tighten screw
with Allen key

WDU 70/95

95 mm²

Conductor can be inserted from above / leaf spring

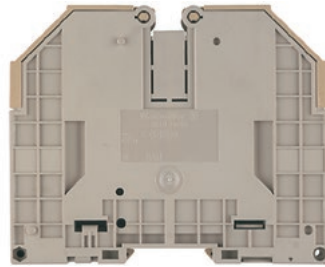

27 x 132 x 107	
232 / 120	
13.3...120	

WDU 120/150

120 mm²

Conductor can be inserted from above / leaf spring

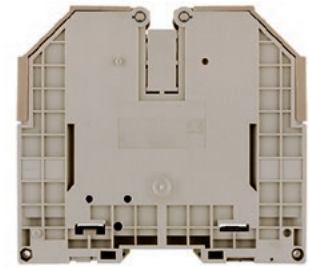

32 x 132 x 117	
309 / 150	
33.63...150	

Width/Height/Depth	mm
max. current / max. cond. cross-section	A/mm ²
Max. clamping range	mm ²

Technical data

Rated data	
Rated voltage	V
Rated current	A
for wire cross-section	mm ²
Rated impulse withstand voltage / Pollution severity	
Gauge to IEC 60947-1 / UL 94 flammability rating	
Approvals	
Clamped conductors (H05V/H07V)	
Solid / Stranded	mm ²
Flexible / Flexible with ferrule	mm ²
Tightening torque (clamping screw for copper conductors)	-
Stripping length / Blade size	mm/-
2 conductors with same cross-section (H05V/H07V)	
Solid / Stranded	mm ²
Flexible / Flexible with ferrule	mm ²
Note	

IEC 60947-1	Ex e II		II 2 G D
IEC	UL	CSA	EN 60079-7
1000	1000	600	1100
232	175	205	218
95	AWG 6...0	AWG 6...0	95 mm ²
8 kV / 3			
B12 / V-0			
DEMKO14ATEX1338U			
Rated connection	Further connection		
16...16 / 16...120			
16...95 / 16...95			
6...12 Nm / (M 8)			
30 / S6 (DIN 6911)			
16...16 / 16...35			
16...35 / 16...35			

IEC 60947-1	Ex e II		II 2 G D
IEC	UL	CSA	EN 60079-7
1000	1000	600	1100
269	225	285	265
120	AWG 2...250	AWG 2...250	150 mm ²
8 kV / 3			
B13 / V-0			
DEMKO14ATEX1338U			
Rated connection	Further connection		
/ 35...150			
35...150 / 35...150			
10...20 Nm / (M 10)			
35 / S6 (DIN 6911)			
...16 / 35...70			
35...70 / 35...70			

Ordering data

Version	
	dark beige
	blue
Note	

Type	Qty.	Order No.
WDU 70/95	10	1024600000
WDU 70/95 BL	10	1024680000
For details on ribbon cable, see our online catalogue and for information on direct mounting, see section on W-series Accessories.		

Type	Qty.	Order No.
WDU 120/150	10	1024500000
WDU 120/150 BL	10	1024580000
For direct mounting see section W-Series, Accessories.		

Accessories

Screwable cross-connection	
	2-pole
	3-pole
End bracket	dark beige
Cover	With lightning flash symbol
	Blank, white
Additional connection	4 mm ²
Ribbon cable clamp	
Identification systems	
Screwdriver	Standard

Type	current	Qty.	Order No.
WQV 70/95/2	192 A	5	1063500000
WQV 70/95/3	232 A	5	1063600000
WEW 35/1		50	1059000000
WAD 27 M. BL		10	1062860000
WAD 27 NEUTRAL		10	1062960000
WZAD 70/95		10	1066000000
WFL 70/95		5	1616330000
DEK 5/5 MC NE WS		1000	1609801044
WS 12/6.5 MC NE WS		540	1609920000
SKS 2,0-8,0 MR		1	9008870000

Type	current	Qty.	Order No.
WQV 120/2	269 A	5	1063300000
WQV 120/3	269 A	5	1063400000
WEW 35/1		50	1059000000
WAD 27 M. BL		10	1062860000
WAD 27 NEUTRAL		10	1062960000
WZAD120		10	1066100000
WFL 120/150		5	1616340000
DEK 5/5 MC NE WS		1000	1609801044
WS 12/6.5 MC NE WS		540	1609920000
SKS 2,0-8,0 MR		1	9008870000

For detailed information on other accessories and application in the online catalogue

Auxiliary connection for the additional conductor "WZAD 70", order No. 1066000000 (up to 4 mm², 32 A). Cross-connections, see section "W series accessories".

Auxiliary connection for the additional conductor "WZAD 120", order no. 1066100000 (up to 4 mm², 32 A). Cross-connections, see section "W series accessories".

Screw connection with clamping yoke technology (W-Series)

Feed-through terminal blocks

Universal range

A

WDK 1.5/R3.5

1.5 mm²

Double feed-through terminal

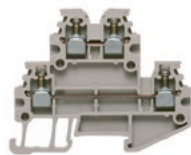

Width/Height/Depth	mm
max. current / max. cond. cross-section	A/mm ²
Max. clamping range	mm ²

3.5 x 46.5 x 37.5	
16 / 15	
0.13...1.5	

Technical data

Rated data	
Rated voltage	V
Rated current	A
for wire cross-section	mm ²
Rated impulse withstand voltage / Pollution severity	
Gauge to IEC 60947-1 / UL 94 flammability rating	
Approvals	
Clamped conductors (H05V/H07V)	
Solid / Stranded	mm ²
Flexible / Flexible with ferrule	mm ²
Tightening torque (clamping screw for copper conductors)	-
Stripping length / Blade size	mm/-
2 conductors with same cross-section (H05V/H07V)	
Solid / Stranded	mm ²
Flexible / Flexible with ferrule	mm ²
Note	

IEC 60947-1	Ex e II		II 2 G D
IEC	UL	CSA	EN 60079-7
400	300	300	275
16	15	10	15
1.5	AWG 26...14	AWG 26...14	1.5 mm ²
4 kV / 3			
A1 / V-0			
KEMA99ATEX6545U			
Rated connection	Further connection		
0.5...1.5 / 1.5...1.5			
0.5...1.5 / 0.5...1.5			
0.3 Nm / (M 2)			
7 / 0.4 x 2.5 mm			
0.5...0.75			
0.5...0.75 / 0.5...0.5			
PZ 6/5 recommended as crimping tool for 1.5 mm ² with wire-end ferrule			

Ordering data

Version	
	dark beige
	blue
Note	

Type	Qty.	Order No.
WDK 1.5/R3.5	100	1753290000

Accessories

Pluggable cross-connection	
	2-pole
	10-pole
	2-pole
	10-pole
	2-pole
	10-pole
Screwable cross-connection	
	2-pole
	10-pole
End plate / Partition plate	
	dark beige
	Blue
	dark beige
End bracket	
	dark beige
Cover	
	With lightning flash symbol
	Blank, white
Identification systems	

Type	current	Qty.	Order No.
ZQV 1.5N/2	17.5 A	60	1985410000
ZQV 1.5N/10	17.5 A	20	1985580000
WAP WDK1.5/R3.5		20	1754200000
EW 15		50	0382860000
DEK 5/3.5 MC NE WS		500	1755270000
DEK 5/3.5 MM WS		1000	2007100000
WS 8/3.5 MM WS		1000	2007140000

For detailed information on other accessories and application in the online catalogue

Cross-connections, see section "W series accessories".

WDK 2.5

2.5 mm²

Screwable cross-connection

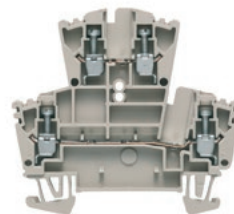

5.1 x 69.5 x 62.5	
32 / 4	
0.05...4	

IEC 60947-1	Ex e II		II 2 G D
IEC	UL	CSA	EN 60079-7
400	600	300	275
24	20	10	21
2.5	AWG 22...12	AWG 26...12	2.5 mm ²
6 kV / 3			
A3 / V-0			
KEMA98ATEX1687U			
Rated connection	Further connection		
0.5...4 / 1.5...4			
0.5...4 / 0.5...2.5			
0.4...0.6 Nm / (M 2.5)			
10 / 0.6 x 3.5 mm			
0.5...1.5			
0.5...1.5 / 0.5...1.5			
2.5 mm ² conductor with ferrule with plastic collar, with the collar optimised for diameter only (order No. 1333100000, QTY 500).			

Type	Qty.	Order No.
WDK 2.5	100	1021500000
WDK 2.5 BL	100	1021580000

For colour versions, see section on W-series Accessories - specific functions.

Type	current	Qty.	Order No.
WQV 2.5/2	32 A	50	1053660000
WQV 2.5/10	32 A	20	1054460000
WAP WDK2.5		20	1059100000
WAP WDK2.5 BL		20	1059180000
WTW EN		20	1058800000
WEW 35/2		100	1061200000
WAD 4 GE BED		50	1072000000
WAD 4 WS		50	1072100000
DEK 5/5 MC NE WS		1000	1609801044
WS 8/5 MC NE WS		720	1640740000
DEK 5/5 MM WS		800	2007110000
WS 8/5 MM WS		800	2007150000

Cross-connections, test and socket plug, see section "W series accessories". Ensure 2.5 mm² max. when using the WDB.

WDK 2.5 ZQV

2.5 mm²

Plug-in cross-connection

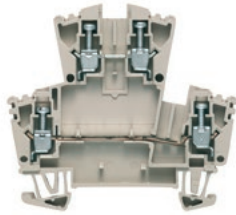

5.1 x 65.4 x 62.5
32 / 4
0.05...4

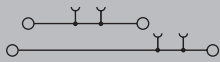

IEC 60947-7-1 Ex e II II 2 G D

IEC	UL	CSA	EN 60079-7
400	600	300	275
24	20	25	21
2.5	AWG 22...12	AWG 26...12	2.5 mm ²
6 kV / 3			
A3 / V-0			

CE KEMA98ATEX1687U

Rated connection	Further connection
0.5...4 / 1.5...4	
0.5...4 / 0.5...2.5	
0.4...0.6 Nm / (M 2.5)	
10 / 0.6 x 3.5 mm	
0.5...1.5	
0.5...1.5 / 0.5...1.5	
2.5 mm ² conductor with ferrule with plastic collar, with the collar optimised for diameter only (order No. 1333100000, QTY 500).	

Type	Qty.	Order No.
WDK 2.5 ZQV	100	1041100000
WDK 2.5 ZQV BL	100	1041180000

Rated voltage is 400 V when using the ZQV cross-connector.
For colour versions, see section on W-series Accessories

Type	current	Qty.	Order No.
ZQV 2.5N/2	24 A	60	1527540000
ZQV 2.5N/10	24 A	20	1527690000
WAP WDK2.5		20	1059100000
WAP WDK2.5 BL		20	1059180000
WTW EN		20	1058800000
WEW 35/2		100	1061200000
WAD 4 GE BED		50	1072000000
WAD 4 WS		50	1072100000
DEK 5/5 MC NE WS		1000	1609801044
WS 8/5 MC NE WS		720	1640740000
DEK 5/5 MM WS		800	2007110000
WS 8/5 MM WS		800	2007150000

Cross-connections, test and socket plug, see section "W series accessories".
Ensure 2.5 mm² max. when using the WDB.

WDK 2.5 V

2.5 mm²

Both levels at one potential

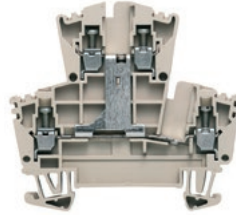

5.1 x 69.5 x 62.5
32 / 4
0.05...4

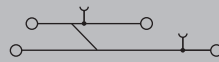

IEC 60947-7-1 Ex e II II 2 G D

IEC	UL	CSA	EN 60079-7
400	600	300	275
24	20	10	21
2.5	AWG 30...12	AWG 26...12	2.5 mm ²
6 kV / 3			
A3 / V-0			

CE KEMA98ATEX1687U

Rated connection	Further connection
0.5...4 / 1.5...4	
0.5...4 / 0.5...2.5	
0.4...0.6 Nm / (M 2.5)	
10 / 0.6 x 3.5 mm	
0.5...1.5	
0.5...1.5 / 0.5...1.5	
2.5 mm ² conductor with ferrule with plastic collar, with the collar optimised for diameter only (order No. 1333100000, QTY 500).	

Type	Qty.	Order No.
WDK 2.5V	100	1022300000
WDK 2.5V BL	100	1022380000

For colour versions, see section on W-series Accessories - specific functions.

Type	current	Qty.	Order No.
WQV 2.5/2	32 A	50	1053660000
WQV 2.5/10	32 A	20	1054460000
WAP WDK2.5		20	1059100000
WAP WDK2.5 BL		20	1059180000
WTW EN		20	1058800000
WEW 35/2		100	1061200000
WAD 4 GE BED		50	1072000000
WAD 4 WS		50	1072100000
DEK 5/5 MC NE WS		1000	1609801044
WS 8/5 MC NE WS		720	1640740000
DEK 5/5 MM WS		800	2007110000
WS 8/5 MM WS		800	2007150000

Cross-connections, test and socket plug, see section "W series accessories".
Ensure 2.5 mm² max. when using the WDB.

WDK 2.5 DU-PE

2.5 mm²

Lower level earthed on terminal rail

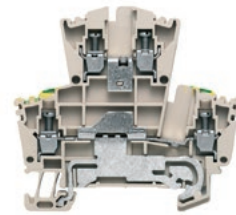

5.1 x 69.5 x 62.5
32 / 4
0.05...4

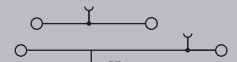

IEC 60947-7-1 (-7-2) Ex e II II 2 G D

IEC	UL	CSA	EN 60079-7
400	300	300	275
24	20	20	21
2.5	AWG 22...12	AWG 22...12	2.5 mm ²
6 kV / 3			
A3 / V-0			

CE KEMA98ATEX1687U

Rated connection	Further connection
0.5...4 / 1.5...4	
0.5...4 / 0.5...2.5	
0.4...0.6 Nm / (M 2.5)	
10 / 0.6 x 3.5 mm	
0.5...1.5	
0.5...1.5 / 0.5...1.5	
2.5 mm ² conductor with ferrule with plastic collar, with the collar optimised for diameter only (order No. 1333100000, QTY 500).	

Type	Qty.	Order No.
WDK 2.5DU-PE	100	1036400000

Type	current	Qty.	Order No.
WQV 2.5/2	32 A	50	1053660000
WQV 2.5/10	32 A	20	1054460000
WAP WDK2.5		20	1059100000
WAP WDK2.5 BL		20	1059180000
WTW EN		20	1058800000
WEW 35/2		100	1061200000
WAD 4 GE BED		50	1072000000
WAD 4 WS		50	1072100000
DEK 5/5 MC NE WS		1000	1609801044
WS 8/5 MC NE WS		720	1640740000
DEK 5/5 MM WS		800	2007110000
WS 8/5 MM WS		800	2007150000

Cross-connections, test and socket plug, see section "W series accessories".
Ensure 2.5 mm² max. when using the WDB.



Screw connection with clamping yoke technology (W-Series)
Feed-through terminal blocks

Universal range

A

WDK 2.5N

2.5 mm²

Plug-in cross-connection
 Compact design

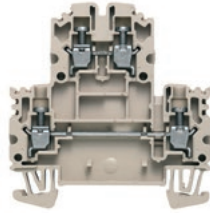

Width/Height/Depth	mm
max. current / max. cond. cross-section	A/mm ²
Max. clamping range	mm ²

5.1 x 61 x 62	
28 / 4	
0.05...4	

Technical data

Rated data	
Rated voltage	V
Rated current	A
for wire cross-section	mm ²
Rated impulse withstand voltage / Pollution severity	
Gauge to IEC 60947-1 / UL 94 flammability rating	
Approvals	
Clamped conductors (H05V/H07V)	
Solid / Stranded	mm ²
Flexible / Flexible with ferrule	mm ²
Tightening torque (clamping screw for copper conductors)	-
Stripping length / Blade size	mm/-
2 conductors with same cross-section (H05V/H07V)	
Solid / Stranded	mm ²
Flexible / Flexible with ferrule	mm ²
Note	

IEC 60947-7-1				Ex e II II 2 G D			
IEC	UL	CSA	EN 60079-7				
800		300	550				
24		20	21				
2.5		AWG 26...12	2.5 mm ²				
				8 kV / 3			
				A3 / V-0			
				KEMA00ATEX2061U			
Rated connection		Further connection					
0.5...4 / 1.5...4							
0.5...4 / 0.5...2.5							
0.4...0.6 Nm / (M 2.5)							
8 / 0.6 x 3.5 mm							
0.5...1.5							
0.5...1.5 / 0.5...1.5							
Rated voltage is reduced to 400 V when using the ZQV 2.5N cross-connector.							

Ordering data

Version	
	dark beige
	blue
Note	

Type	Qty.	Order No.
WDK 2.5N	100	1041600000
WDK 2.5N BL	100	1041680000

Accessories

Pluggable cross-connection	
	2-pole
	10-pole
	2-pole
	10-pole
	2-pole
	10-pole
Screwable cross-connection	
	2-pole
	10-pole
End plate / Partition plate	
	dark beige
	Blue
	dark beige
End bracket	
	dark beige
Cover	
	With lightning flash symbol
	Blank, white
Identification systems	

Type	current	Qty.	Order No.
ZQV 2.5N/2	24 A	60	1527540000
ZQV 2.5N/10	24 A	20	1527690000
End plate / Partition plate			
WAP WDK2.5/4 N		20	1084000000
WAP WDK2.5/4 N BL		20	1084080000
WTW EN		20	1058800000
End bracket			
WEW 35/2		100	1061200000
Cover			
Identification systems			
DEK 5/5 MC NE WS		1000	1609801044
WS 8/5 MC NE WS		720	1640740000
DEK 5/5 MM WS		800	2007110000
WS 8/5 MM WS		800	2007150000

For detailed information on other accessories and application in the online catalogue

Cross-connections, see section "W series accessories".

WDK 2.5N V

2.5 mm²

Both levels at one potential
 Compact design

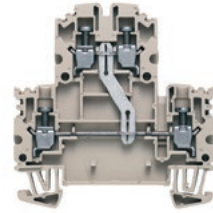

5.1 x 61 x 62	
28 / 4	
0.05...4	

IEC 60947-7-1				Ex e II II 2 G D			
IEC	UL	CSA	EN 60079-7				
800		300	550				
24		20	21				
2.5		AWG 26...12	2.5 mm ²				
				8 kV / 3			
				A3 / V-0			
				KEMA00ATEX2061U			
Rated connection		Further connection					
0.5...4 / 1.5...4							
0.5...4 / 0.5...2.5							
0.4...0.6 Nm / (M 2.5)							
8 / 0.6 x 3.5 mm							
0.5...1.5							
0.5...1.5 / 0.5...1.5							
Rated voltage is reduced to 400 V when using the ZQV cross-connector.							

Type	Qty.	Order No.
WDK 2.5N V	100	1041610000

Type	current	Qty.	Order No.
ZQV 2.5N/2	24 A	60	1527540000
ZQV 2.5N/10	24 A	20	1527690000
End plate / Partition plate			
WAP WDK2.5/4 N		20	1084000000
WAP WDK2.5/4 N BL		20	1084080000
WTW EN		20	1058800000
End bracket			
WEW 35/2		100	1061200000
Cover			
Identification systems			
DEK 5/5 MC NE WS		1000	1609801044
WS 8/5 MC NE WS		720	1640740000
DEK 5/5 MM WS		800	2007110000
WS 8/5 MM WS		800	2007150000

Cross-connections, see section "W series accessories".

WDK 2.5 / 800 V

2.5 mm²

Rated voltage 800 V

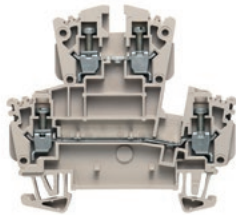

6.1 x 69 x 62.5
32 / 4
0.05...4

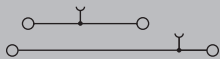

IEC 60947-7-1 Ex e II II 2 G D

IEC	UL	CSA	EN 60079-7
800			440
24			24
2.5		AWG 26...12	2.5 mm ²
8 kV / 3			
A3 / V-0			

KEMA98ATEX1687U	
Rated connection	Further connection
0.5...4 / 1.5...4	
0.5...4 / 0.5...2.5	
0.4...0.6 Nm / (M 2.5)	
10 / 0.6 x 3.5 mm	
0.5...1.5	
0.5...1.5 / 0.5...1.5	

Type	Qty.	Order No.
WDK 2.5/EX	100	1029100000

Type	current	Qty.	Order No.
Q 2 AKZ4SS	20 A	50	0369000000
Q 10 AKZ4SS	20 A	20	0369300000
WAP WDK2.5	20	1059100000	
WAP WDK2.5 BL	20	1059180000	
WAP 16+35 WTW 2.5-10	20	1050100000	
WEW 35/2	100	1061200000	
WAD 4 GE BED	50	1072000000	
WAD 4 WS	50	1072100000	
DEK 5/6 MC NE WS	1000	1609820000	
WS 8/5 MC NE WS	720	1640740000	
DEK 5/5 MM WS	800	2007110000	
WS 8/5 MM WS	800	2007150000	

Cross-connections, test and socket plug, see section "W series accessories".
Ensure 2.5 mm² max. when using the WQB.

WDK 2.5N DU-PE

2.5 mm²

Lower level earthed on terminal rail
Compact design

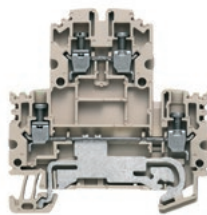

5.1 x 61 x 62
28 / 4
0.05...4



IEC 60947-7-1 (-7-2) Ex e II II 2 G D

IEC	UL	CSA	EN 60079-7
800		300	550
24		20	21
2.5		AWG 26...12	2.5 mm ²
8 kV / 3			
A3 / V-0			

KEMA00ATEX2061U	
Rated connection	Further connection
0.5...4 / 1.5...4	
0.5...4 / 0.5...2.5	
0.4...0.6 Nm / (M 2.5)	
8 / 0.6 x 3.5 mm	
0.5...1.5	
0.5...1.5 / 0.5...1.5	

Rated voltage is reduced to 400 V when using the ZQV cross-connector. 2 conductors via the PE connection are not permissible!

Type	Qty.	Order No.
WDK 2.5N DU-PE	100	1041650000

Type	current	Qty.	Order No.
ZQV 2.5N/2	24 A	60	1527540000
ZQV 2.5N/10	24 A	20	1527690000
WAP WDK2.5/4 N	20	1084000000	
WAP WDK2.5/4 N BL	20	1084080000	
WTW EN	20	1058800000	
WEW 35/2	100	1061200000	
DEK 5/5 MC NE WS	1000	1609801044	
WS 8/5 MC NE WS	720	1640740000	
DEK 5/5 MM WS	800	2007110000	
WS 8/5 MM WS	800	2007150000	

Cross-connections, see section "W series accessories".

WDK 4N

4 mm²

Solid / stranded
Flexible / flexible with wire-end ferrule

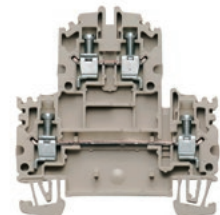

6.1 x 60 x 63.25
35 / 6
0.13...6

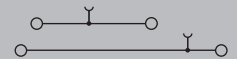

IEC 60947-7-1 Ex e II II 2 G D

IEC	UL	CSA	EN 60079-7
800	600	300	550
32	35	30	28
4	AWG 26...10	AWG 26...10	4 mm ²
8 kV / 3			
A4 / V-0			

KEMA00ATEX2061U	
Rated connection	Further connection
0.5...6 / 1.5...6	
0.5...4 / 0.5...4	
0.5...1 Nm / (M 3)	
8 / 0.6 x 3.5 mm	
0.5...1.5	
0.5...1.5 / 0.5...1.5	

Rated voltage: 400 V when using ZQV cross-connection
2 wire H07VU1.5, tighten with 0.6 Nm.

Type	Qty.	Order No.
WDK 4N	100	1041900000
WDK 4N BL	100	1041980000

Type	current	Qty.	Order No.
ZQV 4N/2	32 A	60	1527930000
ZQV 4N/10	32 A	20	1528090000
WAP WDK2.5/4 N	20	1084000000	
WAP WDK2.5/4 N BL	20	1084080000	
WTW EN	20	1058800000	
WEW 35/2	100	1061200000	
DEK 5/6 MC NE WS	1000	1609820000	
WS 8/6 PLUS MC NE WS	600	1951880000	
DEK 5/6 MM WS	600	2007120000	
WS 8/6 MM WS	600	2007160000	

Cross-connections, see section "W series accessories".



Screw connection with clamping yoke technology (W-Series)

Feed-through terminal blocks

Universal range

A

WDK 4N V

4 mm²

Both levels at one potential
Compact design

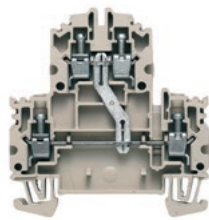

WDK 10

10 mm²

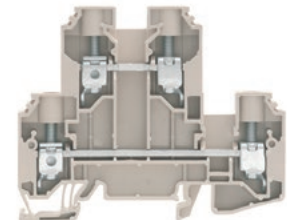

Width/Height/Depth	mm
max. current / max. cond. cross-section	A/mm ²
Max. clamping range	mm ²

6.1 x 60.7 x 63.25	
35 / 6	
0.13...6	

9.9 x 85 x 69	
70 / 16	
1.5...16	

Technical data

Rated data	
Rated voltage	V
Rated current	A
for wire cross-section	mm ²
Rated impulse withstand voltage / Pollution severity	
Gauge to IEC 60947-1 / UL 94 flammability rating	
Approvals	
Clamped conductors (H05V/H07V)	
Solid / Stranded	mm ²
Flexible / Flexible with ferrule	mm ²
Tightening torque (clamping screw for copper conductors)	-
Stripping length / Blade size	mm/-
2 conductors with same cross-section (H05V/H07V)	
Solid / Stranded	mm ²
Flexible / Flexible with ferrule	mm ²
Note	

IEC 60947-7-1	Ex e II		II 2 G D
IEC	UL	CSA	EN 60079-7
800	600	300	550
32	35	30	28
4	AWG 26...10	AWG 26...10	4 mm ²
8 kV / 3			
A4 / V-0			
CE			
KEMA00ATEX2061U			
Rated connection	Further connection		
0.5...6 / 1.5...6			
0.5...4 / 0.5...4			
0.5...1 Nm / (M 3)			
8 / 0.6 x 3.5 mm			
0.5...1.5			
0.5...1.5 / 0.5...1.5			
Rated voltage: 400 V when using ZQV cross-connection 2 wire H07V-U1.5, tighten with 0.6 Nm.			

IEC 60947-7-1			
IEC	UL	CSA	EN 60079-7
800	600	600	
57	64	64	
10	AWG 18...6	AWG 18...6	
8 kV / 3			
B6 / V-0			
Rated connection	Further connection		
1.5...16 / 1.5...16			
1.5...16 / 1.5...16			
1.2...1.9 Nm / (M 4)			
12 / 1.0 x 5.5 mm			

Ordering data

Version	dark beige
	blue
	dark beige / blue
Note	

Type	Qty.	Order No.
WDK 4N V	100	1041910000

Type	Qty.	Order No.
WDK 10	50	1186740000
WDK 10 BL	50	1186750000

Accessories

Pluggable cross-connection	
	2-pole
	10-pole
End plate / Partition plate	
	dark beige
	Blue
	dark beige
End bracket	
	dark beige
Identification systems	
Screwable cross-connection	
	2-pole
	10-pole
Cover	
	Blank, white
	Blank, yellow
Screwdriver	
	Standard

Type	current	Qty.	Order No.
ZQV 4N/2	32 A	60	1527930000
ZQV 4N/10	32 A	20	1528090000
WAP WDK2.5/4 N		20	1084000000
WAP WDK2.5/4 N BL		20	1084080000
WTW EN		20	1058800000
WEW 35/2		100	1061200000
DEK 5/6 MC NE WS		1000	1609820000
WS 8/6 PLUS MC NE WS		600	1951880000
DEK 5/5 MM WS		800	2007110000
WS 8/5 MM WS		800	2007150000

Type	current	Qty.	Order No.
WAP WDK10		20	1186720000
WAP WDK10 BL		20	1186730000
WEW 35/2		100	1061200000
DEK 5/5 MC NE WS		1000	1609801044
WQV 10/2	57 A	50	1052560000
WQV 10/10	57 A	20	1052460000
WAD 8 MC NE WS		48	1112940000
WAD 8 MC NE GE		48	1112950000
SDS 1.0X5.5X150		1	9008350000

For detailed information on other accessories and application in the online catalogue

Cross-connections, see section "W series accessories".

Cross-connections, see section "W series accessories".

WDK 10 V

10 mm²

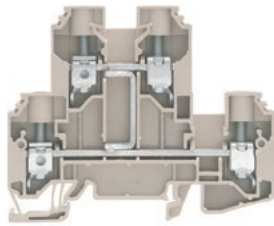

9.9 x 85 x 69
73 / 16
1.5...16

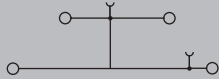

IEC 60947-7-1

IEC	UL	CSA	EN 60079-7
800	600	600	
57	49	49	
10	AWG 18...6	AWG 18...6	
8 kV / 3			
B6 / V-0			

Rated connection	Further connection
1.5...16 / 1.5...16	
1.5...16 / 1.5...16	
1.2...1.9 Nm / (M 4)	
12 / 1.0 x 5.5 mm	

Type	Qty.	Order No.
WDK 10 V	50	1186770000
WDK 10 V BL	50	1186780000

Type	current	Qty.	Order No.
WAP WDK10		20	1186720000
WAP WDK10 BL		20	1186730000
WEW 35/2		100	1061200000
DEK 5/5 MC NE WS		1000	1609801044
WQV 10/2	57 A	50	1052560000
WQV 10/10	57 A	20	1052460000
WAD 8 MC NE WS		48	1112940000
WAD 8 MC NE GE		48	1112950000
SDS 1.0X5.5X150		1	9008350000

Cross-connections, see section "W series accessories".

WDK 10 L

10 mm²

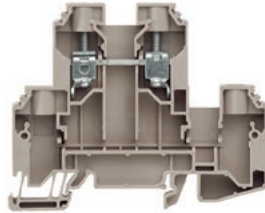

9.9 x 85 x 69
70 / 16
1.5...16

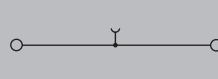

IEC 60947-7-1

IEC	UL	CSA	EN 60079-7
800		1000	
57		70	
10	AWG 18...6	AWG 18...6	
8 kV / 3			
B6 / V-0			

Rated connection	Further connection
1.5...16 / 1.5...16	
1.5...16 / 1.5...16	
1.2...1.9 Nm / (M 4)	
12 / 1.0 x 5.5 mm	

Type	Qty.	Order No.
WDK 10 L	50	1415510000

Type	current	Qty.	Order No.
WAP WDK10		20	1186720000
WAP WDK10 BL		20	1186730000
WEW 35/2		100	1061200000
DEK 5/5 MC NE WS		1000	1609801044
WQV 10/2	57 A	50	1052560000
WQV 10/10	57 A	20	1052460000
WAD 8 MC NE WS		48	1112940000
WAD 8 MC NE GE		48	1112950000
SDS 1.0X5.5X150		1	9008350000

Cross-connections, see section "W series accessories".

WDK 10 DU-N

10 mm²

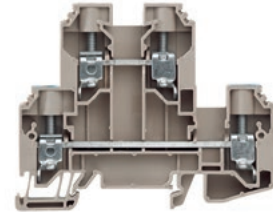

9.9 x 85 x 69
70 / 16
1.5...16

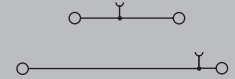

IEC 60947-7-1

IEC	UL	CSA	EN 60079-7
800	600	600	
57	64	64	
10	AWG 18...6	AWG 18...6	
8 kV / 3			
B6 / V-0			

Rated connection	Further connection
1.5...16 / 1.5...16	
1.5...16 / 1.5...16	
1.2...1.9 Nm / (M 4)	
12 / 1.0 x 5.5 mm	

Type	Qty.	Order No.
WDK 10 DU-N	50	1415520000

Type	current	Qty.	Order No.
WAP WDK10		20	1186720000
WAP WDK10 BL		20	1186730000
WEW 35/2		100	1061200000
DEK 5/5 MC NE WS		1000	1609801044
WQV 10/2	57 A	50	1052560000
WQV 10/10	57 A	20	1052460000
WAD 8 MC NE WS		48	1112940000
WAD 8 MC NE GE		48	1112950000
SDS 1.0X5.5X150		1	9008350000

Cross-connections, see section "W series accessories".



Screw connection with clamping yoke technology (W-Series)

Feed-through terminal blocks

WDK 10 DU-PE

10 mm²

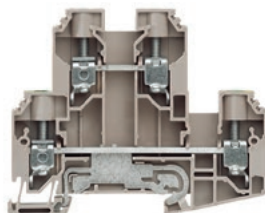

WDK 10 SET BCD

10 mm²

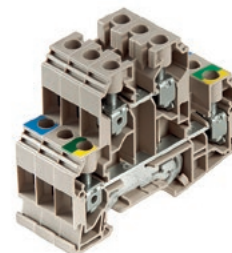

Width/Height/Depth	mm
max. current / max. cond. cross-section	A/mm ²
Max. clamping range	mm ²

9.9 x 85 x 69	
70 / 16	
1.5...16	

29.7 x 85 x 69	
70 / 16	
1.5...16	

Technical data

Rated data	
Rated voltage	V
Rated current	A
for wire cross-section	mm ²
Rated impulse withstand voltage / Pollution severity	
Gauge to IEC 60947-1 / UL 94 flammability rating	
Approvals	
Clamped conductors (H05V/H07V)	
Solid / Stranded	mm ²
Flexible / Flexible with ferrule	mm ²
Tightening torque (clamping screw for copper conductors)	-
Stripping length / Blade size	mm/-
2 conductors with same cross-section (H05V/H07V)	
Solid / Stranded	-
Flexible / Flexible with ferrule	-
Note	

IEC 60947-7-1 (-7-2)			
IEC	UL	CSA	EN 60079-7
800	600	600	
57	40	40	
10	AWG 18...6	AWG 18...6	
8 kV / 3			
B6 / V-0			
Rated connection		Further connection	
1.5...16 / 1.5...16			
1.5...16 / 1.5...16			
1.2...1.9 Nm / (M 4)			
12 / 1.0 x 5.5 mm			
Note			

IEC 60947-7-1 (-7-2)			
IEC	UL	CSA	EN 60079-7
800	600	600	
57	64	64	
10	AWG 18...6	AWG 18...6	
8 kV / 3			
B6 / V-0			
Rated connection		Further connection	
1.5...16 / 1.5...16			
1.5...16 / 1.5...16			
1.2...1.9 Nm / (M 4)			
12 / 1.0 x 5.5 mm			
Note			

Ordering data

Version	
	dark beige
	with PE foot
	dark beige / green / yellow
Note	

Type	Qty.	Order No.
WDK 10 DU-PE	50	1415480000
Note		

Type	Qty.	Order No.
WDK 10 SET BCD	1	1415540000
Note		

Accessories

Screwable cross-connection	
	2-pole
	10-pole
End plate / Partition plate	
	dark beige
	Blue
End bracket	
	dark beige
Screwdriver	
	Standard
Cover	
	Blank, white
	Blank, yellow
Identification systems	
Cross-connection	
	black
	blue
	red

Type	current	Qty.	Order No.
WQV 10/2	57 A	50	1052560000
WQV 10/10	57 A	20	1052460000
WAP WDK10		20	1186720000
WAP WDK10 BL		20	1186730000
WEW 35/2		100	1061200000
SDS 1.0x5.5x150		1	9008350000
WAD 8 MC NE WS		48	1112940000
WAD 8 MC NE GE		48	1112950000
DEK 5/5 MC NE WS		1000	1609801044
Note			

Type	current	Qty.	Order No.
WQV 10/2	57 A	50	1052560000
WQV 10/10	57 A	20	1052460000
WAP WDK10		20	1186720000
WAP WDK10 BL		20	1186730000
WEW 35/2		100	1061200000
SDS 1.0x5.5x150		1	9008350000
WAD 8 MC NE WS		48	1112940000
WAD 8 MC NE GE		48	1112950000
DEK 5/5 MC NE WS		1000	1609801044
Note			

For detailed information on other accessories and application in the online catalogue

Cross-connections, see section "W series accessories".

Cross-connections, see section "W series accessories".

WDK 10 SET LS

10 mm²

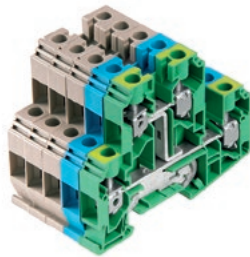

49.5 x 85 x 69
70 / 16
1.5...16

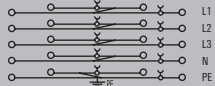

IEC 60947-7-1 (-7-2)

IEC	UL	CSA	EN 60079-7
800	600	600	
57	64	64	
10	AWG 18...6	AWG 18...6	
8 kV / 3			
B6 / V-0			



Rated connection	Further connection
1.5...16 / 1.5...16	
1.5...16 / 1.5...16	
1.2...1.9 Nm / (M 4)	
12 / 1.0 x 5.5 mm	

Type	Qty.	Order No.
WDK 10 SET LS	1	1415530000

Type	current	Qty.	Order No.
WQV 10/2	57 A	50	1052560000
WQV 10/10	57 A	20	1052460000
WAP WDK10		20	1186720000
WAP WDK10 BL		20	1186730000
WEW 35/2		100	1061200000
SDS 1.0X5.5X150		1	9008350000
WAD 8 MC NE WS		48	1112940000
WAD 8 MC NE GE		48	1112950000
DEK 5/5 MC NE WS		1000	1609801044

MAK 2.5

2.5 mm²

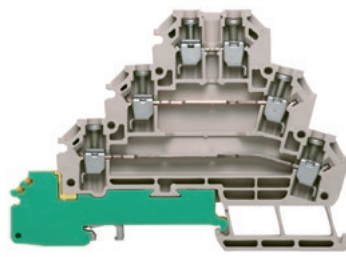

6.2 x 88 x 63
31 / 4
0.13...4

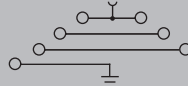

IEC 60947-7-1 (-7-2)

IEC	UL	CSA	EN 60079-7
500	300	300	
24	10	10	
2.5	AWG 26...12	AWG 26...12	
6 kV / 3			
A3 / V-0			



Rated connection	Further connection
0.5...4 / 0.5...4	
0.5...4 / 0.5...2.5	
0.4...0.6 Nm / (M 2.5)	
8 / 0.6 x 3.5 mm	

0.5...1 / 0.5...1
0.5...1 / 0.5...0.75

Type	Qty.	Order No.
MAK 2.5 DB	50	7917030000

Type	current	Qty.	Order No.
AP MAK2.5 DB		20	7917000000
WEW 35/1		50	1059000000
SDIS 0.6X3.5X100		1	9008390000
DEK 5/5 MC NE WS		1000	1609801044
VQB 1.5/50 SW	17.5 A	5	1635120000
VQB 1.5/50 BL	17.5 A	5	1633280000
VQB 1.5/50 RT	17.5 A	5	1633290000

VLI 1.5

1.5 mm²

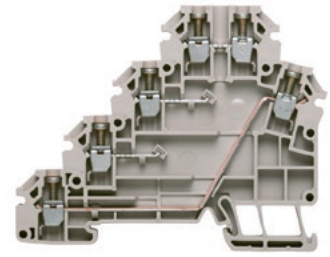

6.15 x 79.5 x 63
24 / 4
0.13...4

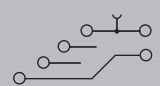

IEC 60947-7-1

IEC	UL	CSA	EN 60079-7
250	300		
17.5	10		
1.5	AWG 26...12		
4 kV / 3			
A3 / V-0			



Rated connection	Further connection
0.5...4 / 0.5...2.5	
0.5...4 / 0.5...2.5	
0.4...0.6 Nm / (M 2.5)	
8 / 0.6 x 3.5 mm	

0.5...1 / 0.5...1
0.5...1 / 0.5...0.75

Type	Qty.	Order No.
VLI 1.5 DB	50	1784120000
VLI 1.5/PE DB	50	1784130000

Type	current	Qty.	Order No.
AP VLI1.5 DB		20	1784150000
WEW 35/1		50	1059000000
SDIS 0.6X3.5X100		1	9008390000
DEK 5/5 MC NE WS		1000	1609801044
VQB 1.5/50 SW	17.5 A	5	1635120000
VQB 1.5/50 BL	17.5 A	5	1633280000
VQB 1.5/50 RT	17.5 A	5	1633290000

Cross-connections, see section "W series accessories".



Screw connection with clamping yoke technology (W-Series)

PE terminal blocks

Universal range

A

WPE 1.5/R3.5

1.5 mm²

Protective earth terminal for TS 15



Width/Height/Depth	mm
max. current / max. cond. cross-section	-/mm ²
Max. clamping range	mm ²

3.5 x 24.5 x 24	
/ 1.5	
0.13...1.5	

Technical data

Rated data	
for wire cross-section	mm ²
Rated voltage to adjoining terminal	V
Rated impulse withstand voltage to adjacent terminal	kV
Rated short-time current	
Pollution severity	
Gauge to IEC 60947-1 / UL 94 flammability rating	
Approvals	
Clamped conductors (H05V/H07V)	
Solid / Stranded	mm ²
Flexible / Flexible with ferrule	mm ²
Tightening torque (clamping screw for copper conductors)	
Tightening torque (mounting screw)	
Stripping length / Blade size	mm/-
Note	

IEC 60947-7-2				Ex e II II 2 G D	
IEC	UL	CSA	EN 60079-7		
1.5	AWG 26...18	AWG 26...18	1.5 mm ²		
400					
6					
				180 A (1.5 mm ²)	
				3	
				A1 / V-0	
CE					
Rated connection					
0.5...1.5 / 1.5...1.5					
0.5...1.5 / 0.5...1.5					
0.3 Nm / (M 2)					
7 / 0.4 x 2.5 mm					
PZ 6/5 recommended as crimping tool for 1.5 mm ² with wire-end ferrule					

Ordering data

Version	green/yellow
Note	

Type	Qty.	Order No.
WPE 1.5/R3.5	100	1798460000

Accessories

End plate / Partition plate	dark beige
End bracket	dark beige
Screwdriver	Standard
Identification systems	

Type	current	Qty.	Order No.
WAP WDU1.5/R3.5		20	1754190000
EW 15		50	0382860000
DEK 5/3.5 MC NE WS		500	1755270000
DEK 5/3.5 MM WS		1000	2007100000
WS 8/3.5 MM WS		1000	2007140000

For detailed information on other accessories and application in the online catalogue

WPE 1.5/ZZ

1.5 mm²

Twin connection



5.1 x 60 x 46.5	
/ 2.5	
0.13...2.5	

IEC 60947-7-2				Ex e II II 2 G D	
IEC	UL	CSA	EN 60079-7		
1.5	AWG 26...14	AWG 26...14	1.5 mm ²		
800					
8					
				180 A (1.5 mm ²)	
				3	
				A1 / V-0	
CE					
Rated connection					
0.5...2.5 / 1.5...2.5					
0.5...1.5 / 0.5...1.5					
0.4...0.6 Nm / (M 2.5)					
0.4...0.6 Nm					
7 / 0.6 x 3.5 mm					

Type	Qty.	Order No.
WPE 1.5/ZZ	100	1016500000

Type	current	Qty.	Order No.
WAP 2.5-10		50	1050000000
WEW 35/2		100	1061200000
SDS 0.6X3.5X100		1	9008330000
DEK 5/5 MC NE WS		1000	1609801044
WS 12/5 MC NE WS		720	1609860000
DEK 5/5 MM WS		800	2007110000
WS 8/5 MM WS		800	2007150000

Rail support protective insulation for installation of mounting rail "SH 2" order No. 0494920000 (QTY 10).

WPE 2.5/1.5/ZR

2.5 mm²

Supplementary connection, right 1.5 mm²

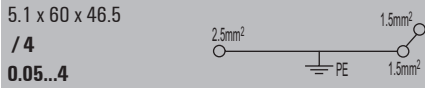

IEC 60947-7-2 Ex e II II 2 G D

IEC	UL	CSA	EN 60079-7
2.5	AWG 26...12	AWG 26...12	1.5 mm ²
800			
8			
300 A (2.5 mm ²)			
3			
A3 / V-0			

CE

Rated connection

0.5...4 / 1.5...4

0.5...4 / 0.5...2.5

0.4...0.6 Nm / (M 2.5)

0.4...0.6 Nm

10 / 0.6 x 3.5 mm

2.5 mm² conductor with ferrule with plastic collar, with the collar optimised for diameter only (order No. 1333100000, QTY 500).

Type	Qty.	Order No.
WPE 2.5/1.5/ZR	100	1016400000

Type	current	Qty.	Order No.
WAP 2.5-10		50	1050000000
WEW 35/2		100	1061200000
SDS 0.6X3.5X100		1	9008330000
DEK 5/5 MC NE WS		1000	1609801044
WS 12/5 MC NE WS		720	1609860000
DEK 5/5 MM WS		800	2007110000
WS 8/5 MM WS		800	2007150000

Rail support protective insulation for installation of mounting rail "SH 2" order No. 0494920000 (QTY 10).

AKE 2.5

2.5 mm²

Protective earth terminal for TS 15

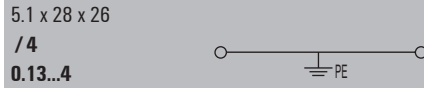

IEC 60947-7-2 Ex e II II 2 G D

IEC	UL	CSA	EN 60079-7
2.5	AWG 26...12	AWG 26...12	2.5 mm ²
250			
4			
300 A (2.5 mm ²)			
3			
A3 / V-2			

CE

Rated connection

0.5...4 / 1.5...2.5

0.5...2.5 / 0.5...2.5

0.4...0.6 Nm / (M 2.5)

0.4...0.6 Nm

7 / 3.0 x 0.5 mm

Type	Qty.	Order No.
AKE 2.5	100	1303360000

Type	current	Qty.	Order No.
DEK 5/5 MC NE WS		1000	1609801044

WPE 2.5

2.5 mm²

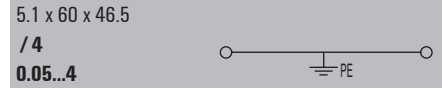
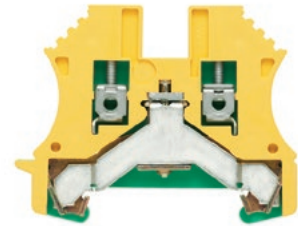

IEC 60947-7-2 Ex e II II 2 G D

IEC	UL	CSA	EN 60079-7
2.5	AWG 26...12	AWG 26...12	2.5 mm ²
800			
8			
300 A (2.5 mm ²)			
3			
A3 / V-0			

CE

Rated connection

0.5...4 / 1.5...4

0.5...4 / 0.5...2.5

0.4...0.6 Nm / (M 2.5)

0.4...0.8 Nm

10 / 0.6 x 3.5 mm

2.5 mm² conductor with ferrule with plastic collar, with the collar optimised for diameter only (order No. 1333100000, QTY 500).

Type	Qty.	Order No.
WPE 2.5	100	1010000000

Type	current	Qty.	Order No.
WAP 2.5-10		50	1050000000
WEW 35/2		100	1061200000
SDS 0.6X3.5X100		1	9008330000
DEK 5/5 MC NE WS		1000	1609801044
WS 12/5 MC NE WS		720	1609860000

Rail support protective insulation for installation of mounting rail "SH 2" order No. 0494920000 (QTY 10).



Screw connection with clamping yoke technology (W-Series)

PE terminal blocks

WPE 2.5N

2.5 mm²

Compact design



Width/Height/Depth	mm
max. current / max. cond. cross-section	-/mm ²
Max. clamping range	mm ²

5.1 x 54 x 37	
/ 4	
0.05...4	

Technical data

Rated data	
for wire cross-section	mm ²
Rated voltage to adjoining terminal	V
Rated impulse withstand voltage to adjacent terminal	kV
Rated short-time current	
Pollution severity	
Gauge to IEC 60947-1 / UL 94 flammability rating	
Approvals	
Clamped conductors (H05V/H07V)	
Solid / Stranded	mm ²
Flexible / Flexible with ferrule	mm ²
Tightening torque (clamping screw for copper conductors)	
Tightening torque (mounting screw)	
Stripping length / Blade size	mm/-
Note	

IEC 60947-7-2				Ex e II II 2 G D	
IEC	UL	CSA	EN 60079-7		
2.5	AWG 26...12	AWG 26...12	2.5 mm ²		
500					
6					
			300 A (2.5 mm ²)		
			3		
			A3 / V-0		
CE					
Rated connection					
0.5...4 / 1.5...4					
0.5...4 / 0.5...2.5					
0.4...0.6 Nm / (M 2.5)					
0.4...0.6 Nm					
10 / 0.6 x 3.5 mm					
2.5 mm ² conductor with ferrule with plastic collar, with the collar optimised for diameter only (order No. 1333100000, QTY 500).					

Ordering data

Version	
	green/yellow
Note	

Type	Qty.	Order No.
WPE 2.5N	100	1016200000

Accessories

End plate / Partition plate	
	dark beige
End bracket	
	dark beige
Screwdriver	
	Standard
Identification systems	

Type	current	Qty.	Order No.
WAP WDU2.5N/4N		50	1060000000
WEW 35/2		100	1061200000
SDS 0.6X3.5X100		1	9008330000
DEK 5/5 MC NE WS		1000	1609801044
WS 12/5 MC NE WS		720	1609860000
DEK 5/5 MM WS		800	2007110000
WS 8/5 MM WS		800	2007150000

For detailed information on other accessories and application in the online catalogue

Rail support protective insulation for installation of mounting rail "SH 2" order No. 0494920000 (QTY 10).

AKE 4

4 mm²

Protective earth terminal for TS 15



7 x 32 x 34.5	
/ 4	
0.13...4	

IEC 60947-7-2				Ex e II II 2 G D	
IEC	UL	CSA	EN 60079-7		
4	AWG 26...12	AWG 26...12	4 mm ²		
500					
6					
			480 A (4 mm ²)		
			3		
			A3 / V-2		
CE					
Rated connection					
0.5...4 / 1.5...4					
0.5...4 / 0.5...2.5					
0.5...1 Nm / (M 3)					
0.5...1 Nm					
9 / 0.6 x 3.5 mm					

Type	Qty.	Order No.
AKE 4	100	0380260000

Type	current	Qty.	Order No.
DEK 5/6.5 MC NE WS		900	1609840000

WPE 4

4 mm²



6.1 x 56 x 46.5
/ 6
0.13...6

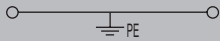

IEC 60947-7-2

Ex e II II 2 G D

IEC	UL	CSA	EN 60079-7
4	AWG 26...10	AWG 26...10	4 mm ²
800			
8			
480 A (4 mm ²)			
3			
A4 / V-0			

CE

Rated connection

0.5...6 / 0.5...6
0.5...6 / 0.5...4
0.5...1 Nm / (M 3)
0.4...0.8 Nm
10 / 0.6 x 3.5 mm

Type	Qty.	Order No.
WPE 4	100	1010100000

Type	current	Qty.	Order No.
WEW 35/2		100	1061200000
SDS 0.6X3.5X100		1	9008330000
DEK 5/6 MC NE WS		1000	1609820000
DEK 5/6 MM WS		600	2007120000
WS 8/6 MM WS		600	2007160000

Rail support protective insulation for installation of mounting rail "SH 2" order No. 0494920000 (QTY 10).

WPE 4/ZZ

4 mm²

Twin connection

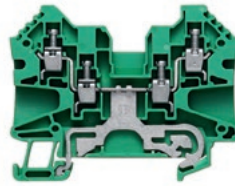

6.1 x 70 x 53
/ 6
0.05...6

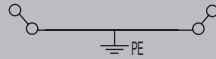

IEC 60947-7-2

Ex e II II 2 G D

IEC	UL	CSA	EN 60079-7
4	AWG 30...10	AWG 30...10	4 mm ²
800			
8			
480 A (4 mm ²)			
3			
A4 / V-0			

CE

Rated connection

0.5...6 / 0.5...4
0.5...4 / 0.5...4
0.5...0.8 Nm / (M 3)
10 / 0.6 x 3.5 mm

Type	Qty.	Order No.
WPE 4/ZZ	50	1905130000

Type	current	Qty.	Order No.
WAP WDU/WTR4/ZZ		50	1905150000
WEW 35/2		100	1061200000
SDS 0.6X3.5X100		1	9008330000
DEK 5/6 MC NE WS		1000	1609820000
DEK 5/6 MM WS		600	2007120000
WS 8/6 MM WS		600	2007160000

Rail support protective insulation for installation of mounting rail "SH 2" order No. 0494920000 (QTY 10).

WPE 4/ZR

4 mm²

Additional connection, right side

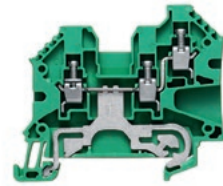

6.1 x 63.5 x 52.8
/ 6
0.05...6

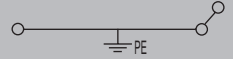

IEC 60947-7-2

Ex e II II 2 G D

IEC	UL	CSA	EN 60079-7
4	AWG 30...10	AWG 30...10	4 mm ²
800			
8			
480 A (4 mm ²)			
3			
A4 / V-0			

CE

Rated connection

0.5...6 / 0.5...4
0.5...4 / 0.5...4
0.5...0.8 Nm / (M 3)
10 / 0.6 x 3.5 mm

Type	Qty.	Order No.
WPE 4/ZR	50	1905120000

Type	current	Qty.	Order No.
WAP WDU/WTR4/ZR		50	1905070000
WEW 35/2		100	1061200000
SDS 0.6X3.5X100		1	9008330000
DEK 5/6 MC NE WS		1000	1609820000
DEK 5/6 MM WS		600	2007120000
WS 8/6 MM WS		600	2007160000

Rail support protective insulation for installation of mounting rail "SH 2" order No. 0494920000 (QTY 10).



Screw connection with clamping yoke technology (W-Series)

PE terminal blocks

Universal range

A

WPE 4N

4 mm²

Compact design

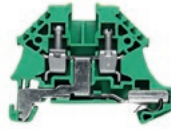

Width/Height/Depth	mm
max. current / max. cond. cross-section	-/mm ²
Max. clamping range	mm ²

6.1 x 50 x 37	
/ 6	
0.13...6	

Technical data

Rated data	
for wire cross-section	mm ²
Rated voltage to adjoining terminal	V
Rated impulse withstand voltage to adjacent terminal	kV
Rated short-time current	
Pollution severity	
Gauge to IEC 60947-1 / UL 94 flammability rating	
Approvals	
Clamped conductors (H05V/H07V)	
Solid / Stranded	mm ²
Flexible / Flexible with ferrule	mm ²
Tightening torque (clamping screw for copper conductors)	
Tightening torque (mounting screw)	
Stripping length / Blade size	mm/-
Note	

Ordering data

Version	Note
green/yellow	

Accessories

End plate / Partition plate	End bracket	Screwdriver	Identification systems	PEN bridge
dark beige	dark beige	Standard		

For detailed information on other accessories and application in the online catalogue

WPE 6

6 mm²



7.9 x 56 x 46.5	
/ 10	
0.08...10	

Rated data	
for wire cross-section	mm ²
Rated voltage to adjoining terminal	V
Rated impulse withstand voltage to adjacent terminal	kV
Rated short-time current	
Pollution severity	
Gauge to IEC 60947-1 / UL 94 flammability rating	
Approvals	
Clamped conductors (H05V/H07V)	
Solid / Stranded	mm ²
Flexible / Flexible with ferrule	mm ²
Tightening torque (clamping screw for copper conductors)	
Tightening torque (mounting screw)	
Stripping length / Blade size	mm/-
Note	

Type	Qty.	Order No.
WPE 6	50	1010200000

Type	current	Qty.	Order No.
WAP WDU2.5N/4N		50	1060000000
WEW 35/2		100	1061200000
SDS 0.6X3.5X100		1	9008330000
SDS 0.8X4.0X100		1	9008340000
DEK 5/6 MC NE WS	1000		1609820000
WS 12/6 MC NE WS	600		1609900000
WS 8/6 MM WS	600		2007160000
DEK 5/6 MM WS	600		2007120000

Rail support protective insulation for installation of mounting rail "SH 2" order No. 0494920000 (QTY 10).

IEC 60947-7-2				Ex e II Ex II 2 G D			
IEC	UL	CSA	EN 60079-7	IEC	UL	CSA	EN 60079-7
4	AWG 26...10	AWG 26...10	4 mm ²	6	AWG 20...8	AWG 20...8	6 mm ²
500				800			
6				8			
480 A (4 mm ²)				720 A (6 mm ²)			
3				3			
A3 / V-0				A5 / V-0			
CE CB CB CB CB CB CB CB							
Rated connection							
0.5...6 / 1.5...6							
0.5...4 / 0.5...4							
0.5...1 Nm / (M 3)							
10 / 0.6 x 3.5 mm							

Type	Qty.	Order No.
WPE 4N	100	1042700000

Type	current	Qty.	Order No.
WAP WDU2.5N/4N		50	1060000000
WEW 35/2		100	1061200000
SDS 0.6X3.5X100		1	9008330000
SDS 0.8X4.0X100		1	9008340000
DEK 5/6 MC NE WS	1000		1609820000
WS 12/6 MC NE WS	600		1609900000
WS 8/6 MM WS	600		2007160000
DEK 5/6 MM WS	600		2007120000

Rail support protective insulation for installation of mounting rail "SH 2" order No. 0494920000 (QTY 10).

WPE 10

10 mm²



9.9 x 56 x 46.5
/ 16
1.31...16

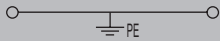

IEC 60947-7-2

Ex e II II 2 G D

IEC	UL	CSA	EN 60079-7
10	AWG 16...6	AWG 16...6	10 mm ²
1000			
8			
1200 A (10 mm ²)			
3			
B6 / V-0			

CE

Rated connection

1.5...16 / 1.5...16
1.5...16 / 1.5...16
1.2...1.9 Nm / (M 4)
0.5...1 Nm
12 / 1.0 x 5.5 mm

AWG 6/7 and H07V-R16 tighten with 2.4 Nm.

Type	Qty.	Order No.
WPE 10	50	1010300000

Type	current	Qty.	Order No.
WEW 35/2		100	1061200000
SDS 1.0X5.5X150		1	9008350000
DEK 5/5 MC NE WS		1000	1609801044
WS 12/6.5 MC NE WS		540	1609920000
WQB-PEN 10	57 A	10	1060300000

WPE 10/ZR

10 mm²

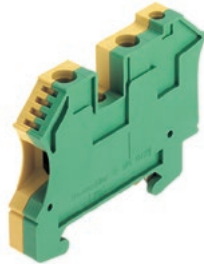

9.9 x 66 x 49
/ 16
1.31...16

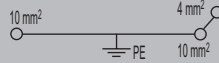

IEC 60947-7-2

IEC	UL	CSA	EN 60079-7
10	AWG 16...6	AWG 14...6	
1000			
8			
1200 A (10 mm ²)			
3			
B6, A4 / V-0			

CE

Rated connection

1.5...16 / 1.5...16
1.5...16 / 1.5...16
1.2...1.9 Nm / (M 4)
0.5...1 Nm
12 / 0.6 x 3.5 mm

Max. conductor cross-sections refer to 10 mm² and 16 mm² connections. Tighten AWG 6/7 and H07V-R16 to 2.4 Nm.

Type	Qty.	Order No.
WPE 10/ZR	50	1042500000

Type	current	Qty.	Order No.
WEW 35/2		100	1061200000
SDS 0.6X3.5X100		1	9008330000
DEK 5/5 MC NE WS		1000	1609801044
WS 12/6.5 MC NE WS		540	1609920000
WQB-PEN 10	57 A	10	1060300000

Rail support protective insulation for installation of mounting rail "SH 2" order No. 0494920000 (QTY 10).

WPE 16

16 mm²



11.9 x 56 x 62.5
/ 25
1.5...25

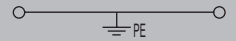

IEC 60947-7-2

Ex e II II 2 G D

IEC	UL	CSA	EN 60079-7
16	AWG 14...4	AWG 14...6	16 mm ²
1000			
8			
1920 A (16 mm ²)			
3			
B7 / V-0			

CE

Rated connection

1.5...16 / 1.5...25
1.5...25 / 1.5...16
2...3.6 Nm / (M 5)
1.2...2.4 Nm
16 / 1.0 x 5.5 mm

For 25 mm² TS 35 x 15 (steel, 1.5 mm thick) should be used. Tighten H07V-16 and AWG 6 conductors to 2.0-2.4 Nm.

Type	Qty.	Order No.
WPE 16	50	1010400000

Type	current	Qty.	Order No.
WEW 35/1		50	1059000000
SDS 1.0X5.5X150		1	9008350000
DEK 5/5 MC NE WS		1000	1609801044
WS 12/6.5 MC NE WS		540	1609920000
WQB-PEN 16	76 A	10	1060200000

Rail support protective insulation for installation of mounting rail "SH 2" order No. 0494920000 (QTY 10).



Screw connection with clamping yoke technology (W-Series)

PE terminal blocks

Universal range

A

WPE 16N

16 mm²

Compact design



WPE 35

35 mm²

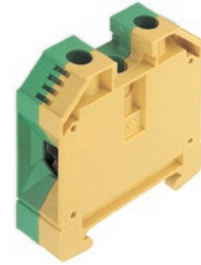

Width/Height/Depth	mm
max. current / max. cond. cross-section	-/mm ²
Max. clamping range	mm ²

12 x 56 x 46.5	
/ 25	
1.5...25	

16 x 56 x 62.5	
/ 35	
2.5...35	

Technical data

Rated data	
for wire cross-section	mm ²
Rated voltage to adjoining terminal	V
Rated impulse withstand voltage to adjacent terminal	kV
Rated short-time current	
Pollution severity	
Gauge to IEC 60947-1 / UL 94 flammability rating	

Clamped conductors (H05V/H07V)	
Solid / Stranded	mm ²
Flexible / Flexible with ferrule	mm ²
Tightening torque (clamping screw for copper conductors)	
Tightening torque (mounting screw)	
Stripping length / Blade size	mm/-

Note

Ordering data

Version	
	green/yellow
Note	

Accessories

PEN bridge	
End bracket	dark beige
Screwdriver	Standard
Identification systems	

IEC 60947-7-2

IEC	UL	CSA	EN 60079-7
16	AWG 14...6	AWG 14...6	
400			
6			
	1920 A (16 mm ²)		
	3		
	B7 / V-0		

CE

Rated connection	
1.5...16 / 1.5...25	
1.5...16 / 1.5...16	
1.2...2.4 Nm / (M 4)	
0.5...1 Nm	
12 / 1.0 x 5.5 mm	

25 mm² stranded requires a tightening torque of 2.2 Nm.

Type	Qty.	Order No.
WPE 16N	50	1019100000

Type	current	Qty.	Order No.
WQV 16N-PEN BL	76 A	10	1071360000
WEW 35/2		100	1061200000
SDS 1.0X5.5X150		1	9008350000
DEK 5/5 MC NE WS		1000	1609801044
WS 12/6.5 MC NE WS		540	1609920000

IEC 60947-7-2

Ex e II II 2 G D

IEC	UL	CSA	EN 60079-7
35	AWG 12...2	AWG 12...2	35 mm ²
800			
8			
	4200 A (35 mm ²)		
	3		
	B8 / V-0		

CE

Rated connection	
2.5...16 / 2.5...35	
2.5...35 / 2.5...35	
5 Nm / (M 6)	
1.2...2.4 Nm	
18 / 6.5 x 1.2 mm	

Type	Qty.	Order No.
WPE 35	25	1010500000

Type	current	Qty.	Order No.
WQB-PEN 35	135 A	10	1060100000
WEW 35/1		50	1059000000
SDS 1.2X6.5X150		1	9009010000
DEK 5/5 MC NE WS		1000	1609801044
WS 12/6.5 MC NE WS		540	1609920000

For detailed information on other accessories and application in the online catalogue

Rail support protective insulation for installation of mounting rail "SH 2" order No. 0494920000 (QTY 10).

Rail support protective insulation for installation of mounting rail "SH 2" order No. 0494920000 (QTY 10).

WPE 35/IKSC

35 mm²

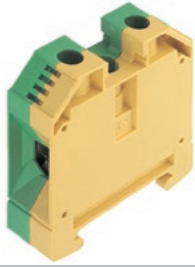

16 x 56 x 62.5
/ 35
2.5...35

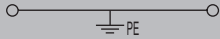

IEC 60947-7-2				Ex e II II 2 G D			
IEC	UL	CSA	EN 60079-7				
35	AWG 12...1	AWG 12...2	35 mm ²				
800							
8							
				4200 A (35 mm ²)			
				3			
				B8 / V-0			

CE

Rated connection

2.5...16 / 2.5...35
2.5...35 / 2.5...35
5 Nm / (M 6)
1.2...2.4 Nm
18 / 6.5 x 1.2 mm

Type	Qty.	Order No.
WPE 35/IKSC	25	1012600000

Type	current	Qty.	Order No.
WQB-PEN 35	135 A	10	1060100000
WEW 35/1		50	1059000000
SDS 1.2X6.5X150		1	9009010000
DEK 5/5 MC NE WS		1000	1609801044
WS 12/6.5 MC NE WS		540	1609920000

Rail support protective insulation for installation of mounting rail "SH 2" order No. 0494920000 (QTY 10).

WPE 35N

35 mm²

Compact design



16 x 66 x 50.5
/ 50
2.5...50

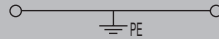

IEC 60947-7-2				Ex e II II 2 G D			
IEC	UL	CSA	EN 60079-7				
35	AWG 12...2		35 mm ²				
400							
6							
				4200 A (35 mm ²)			
				3			
				B8 / V-0			

CE

Rated connection

2.5...16 / 2.5...50
2.5...35 / 2.5...35
4...5 Nm / (M 6)
1.2...2.4 Nm
18 / 6.5 x 1.2 mm

Type	Qty.	Order No.
WPE 35N	20	1717740000

Type	current	Qty.	Order No.
WEW 35/2		100	1061200000
SDS 1.2X6.5X150		1	9009010000
DEK 5/5 MC NE WS		1000	1609801044
WS 12/6.5 MC NE WS		540	1609920000

Rail support protective insulation for installation of mounting rail "SH 2" order No. 0494920000 (QTY 10).

WPE 50N

50 mm²

Compact design



18.5 x 71 x 69.6
/ 70
5.26...70

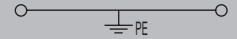

IEC 60947-7-2				Ex e II II 2 G D			
IEC	UL	CSA	EN 60079-7				
50	AWG 10...0	AWG 14...0	50 mm ²				
1000							
8							
				6000 A (50 mm ²)			
				3			
				B10 / V-0			

CE

Rated connection

10...16 / 10...70
10...50 / 10...50
4...6 Nm / (M 6)
3...4 Nm
24 / S4 (DIN 69111)

For 50 and 70 mm², the TS 35 x 15 (copper, 2.3 mm thick) mounting rail should be used.

Type	Qty.	Order No.
WPE 50N	10	1846040000

Type	current	Qty.	Order No.
WQV PEN 50N	150 A	5	9201610000
WEW 35/1		50	1059000000
SKS 2,0-8,0 MR		1	9008870000
DEK 5/8 MC NE WS		800	1856740000
WS 12/6.5 MC NE WS		540	1609920000

Rail support protective insulation for installation of mounting rail "SH 2" order No. 0494920000 (QTY 10).



Screw connection with clamping yoke technology (W-Series)

PE terminal blocks

Universal range

A

WPE 70N/35

70 mm²

Compact design



Width/Height/Depth	mm
max. current / max. cond. cross-section	-/mm ²
Max. clamping range	mm ²

20.5 x 75 x 85	
/ 95	
16...95	

Technical data

Rated data	
for wire cross-section	mm ²
Rated voltage to adjoining terminal	V
Rated impulse withstand voltage to adjacent terminal	kV
Rated short-time current	
Pollution severity	
Gauge to IEC 60947-1 / UL 94 flammability rating	
Approvals	

Clamped conductors (H05V/H07V)

Solid / Stranded	mm ²
Flexible / Flexible with ferrule	mm ²
Tightening torque (clamping screw for copper conductors)	
Tightening torque (mounting screw)	
Stripping length / Blade size	mm/-

Note

Ordering data

Version	green/yellow
Note	

Accessories

PEN bridge	
End bracket	dark beige
Screwdriver	Standard
Identification systems	

For detailed information on other accessories and application in the online catalogue

WPE 95N/120N

95 mm²

Compact design



27 x 91 x 90	
/ 150	
16...150	

IEC 60947-7-2 Ex e II II 2 G D

IEC	UL	CSA	EN 60079-7
70	AWG 6...0	AWG 6...0	70 mm ²
95	AWG 4...0	AWG 4...0	120 mm ²
1000			
8			
	8400 A (70 mm ²)		
	3		
	B11 / V-0		
	11400 A (95 mm ²)		
	3		
	B13 / V-0		

CE

Rated connection

16...16 / 16...95
16...120 / 16...95
16...20 Nm / (M 10)
3...4 Nm
27 / S6 (DIN 6911)

For 50 - 150 mm², the TS 35 x 15 (copper, 2.3 mm thick) mounting rail should be used.

Type	Qty.	Order No.
WPE 95N/120N	5	1846030000
UL, CSA and ATEX certifications are pending		

Type	current	Qty.	Order No.
WQV PEN 95N/120N	192 A	5	9201630000
WEW 35/1		50	1059000000
SKS 2,0-8,0 MR		1	9008870000
DEK 5/5 MC NE WS		1000	1609801044
WS 12/6.5 MC NE WS		540	1609920000

Rail holder for protective isolation installation of the mounting rail "SH 2" Order no. 0494920000 (qty. 10).

Rail support protective insulation for installation of mounting rail "SH 2" order No. 0494920000 (QTY 10).

WPE 70/95

95 mm²

Conductor can be inserted from above / leaf spring

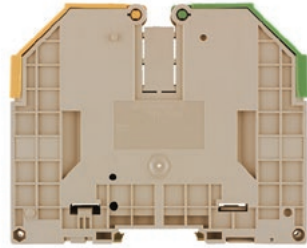

27 x 132 x 107	
/ 120	
13.3...120	

IEC 60947-7-2 Ex e II II 2 G D

IEC	UL	CSA	EN 60079-7
95	AWG 6...0	AWG 6...0	120 mm ²
1000			
8			
11400 A (95 mm ²)			
3			
B12 / V-0			

CE

Rated connection	
16...16 / 16...120	
16...95 / 16...95	
6...12 Nm / (M 8)	
3...6 Nm	
30 / S6 (DIN 6911)	

For 50 - 120 mm², the TS 35 x 15 (copper, 2.3 mm thick) mounting rail should be used.

WPE 120/150

120 mm²

Conductor can be inserted from above / leaf spring

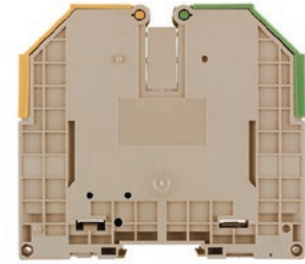

32 x 132 x 117	
/ 150	
33.62...150	

IEC 60947-7-2 Ex e II II 2 G D

IEC	UL	CSA	EN 60079-7
120	AWG 2...250	AWG 2...250	150 mm ²
1000			
8			
14400 A (120 mm ²)			
3			
B13 / V-0			

CE

Rated connection	
/ 35...150	
35...150 / 35...150	
10...20 Nm / (M 10)	
3...6 Nm	
35 / S6 (DIN 6911)	

For 50 - 150 mm², the TS 35 x 15 (copper, 2.3 mm thick) mounting rail should be used.

Width/Height/Depth	mm
max. current / max. cond. cross-section	-/mm ²
Max. clamping range	mm ²

Technical data

Rated data	
for wire cross-section	mm ²
Rated voltage to adjoining terminal	V
Rated impulse withstand voltage to adjacent terminal	kV
Rated short-time current	
Pollution severity	
Gauge to IEC 60947-1 / UL 94 flammability rating	

Clamped conductors (H05V/H07V)	
Solid / Stranded	mm ²
Flexible / Flexible with ferrule	mm ²
Tightening torque (clamping screw for copper conductors)	
Tightening torque (mounting screw)	
Stripping length / Blade size	mm/-

Note

Ordering data

Version	
	green/yellow
Note	

Accessories

PEN bridge	
End bracket	dark beige
Identification systems	
Screwdriver	Standard

Type	Qty.	Order No.
WPE 70/95	10	1037300000

Type	current	Qty.	Order No.
WQV 70/95-PEN	192 A	5	1072300000
WEW 35/1		50	1059000000
DEK 5/5 MC NE WS		1000	1609801044
WS 12/6.5 MC NE WS		540	1609920000
SKS 2,0-8,0 MR		1	9008870000

Type	Qty.	Order No.
WPE 120/150	10	1019700000

Type	current	Qty.	Order No.
WQV 120-PEN	269 A	5	1072400000
WEW 35/1		50	1059000000
DEK 5/5 MC NE WS		1000	1609801044
WS 12/6.5 MC NE WS		540	1609920000
SKS 2,0-8,0 MR		1	9008870000

For detailed information on other accessories and application in the online catalogue

Rail support protective insulation for installation of mounting rail "SH 2" order No. 0494920000 (QTY 10).

Rail support protective insulation for installation of mounting rail "SH 2" order No. 0494920000 (QTY 10).



Screw connection with clamping yoke technology (W-Series)

PE terminal blocks

Universal range

A

WDK 2.5 PE

2.5 mm²



Width/Height/Depth	mm
max. current / max. cond. cross-section	-/mm ²
Max. clamping range	mm ²

5.1 x 69.5 x 62.5	
/ 4	
0.05...4	

Technical data

Rated data	
for wire cross-section	mm ²
Rated voltage to adjoining terminal	V
Rated impulse withstand voltage to adjacent terminal	kV
Rated short-time current	
Pollution severity	
Gauge to IEC 60947-1 / UL 94 flammability rating	
Approvals	
Clamped conductors (H05V/H07V)	
Solid / Stranded	mm ²
Flexible / Flexible with ferrule	mm ²
Tightening torque (clamping screw for copper conductors)	
Stripping length / Blade size	mm/-
Note	

IEC 60947-2	Ex e II		II 2 G D
IEC	UL	CSA	EN 60079-7
2.5	AWG 22...12	AWG 26...12	2.5 mm ²
400			
6			
	300 A (2.5 mm ²)		
	3		
	A3 / V-0		
CE			
Rated connection			
0.5...4 / 1.5...4			
0.5...4 / 0.5...2.5			
0.4...0.6 Nm / (M 2.5)			
10 /			
2.5 mm ² conductor with ferrule with plastic collar, with the collar optimised for diameter only (order No. 1333100000, QTY 500).			

Ordering data

Version	green/yellow
Note	

Accessories

Screwable cross-connection	
	2-pole
	10-pole
End plate / Partition plate	
	dark beige
	Blue
	dark beige
End bracket	
	dark beige
Screwdriver	
	Standard
Identification systems	
Cover	
	Blank, white
	Blank, yellow

For detailed information on other accessories and application in the online catalogue

WDK 2.5N PE

2.5 mm²

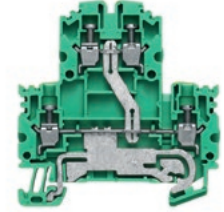

Compact design

5.1 x 60.7 x 54.95	
/ 4	
0.05...4	

IEC 60947-2	Ex e II		II 2 G D
IEC	UL	CSA	EN 60079-7
2.5	AWG 26...12		2.5 mm ²
800			
8			
	300 A (2.5 mm ²)		
	3		
	A3 / V-0		
CE			
Rated connection			
0.5...4 / 1.5...4			
0.5...4 / 0.5...2.5			
0.4...0.6 Nm / (M 2.5)			
8 / 0.6 x 3.5 mm			
2.5 mm ² conductor with ferrule with plastic collar, with the collar optimised for diameter only (order No. 1333100000, QTY 500).			

Type	Qty.	Order No.
WDK 2.5N PE	100	1041620000

Type	current	Qty.	Order No.
WAP WDK2.5/4 N		20	1084000000
WAP WDK2.5/4 N BL		20	1084080000
WTW EN		20	1058800000
WEW 35/2		100	1061200000
SDS 0.6X3.5X100		1	9008330000
DEK 5/5 MC NE WS	1000		1609801044
WS 8/5 MC NE WS	720		1640740000
DEK 5/5 MM WS	800		2007110000
WS 8/5 MM WS	800		2007150000

Rail support for protective-insulated installation of mounting rail "SH 2", order no. 0494920000 (QTY 10). Cross-connections, see section "W series accessories".

WDK 4N PE

4 mm²

Compact design

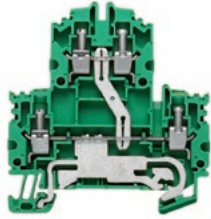

6.1 x 60.7 x 63.25
/ 6
0.13...6

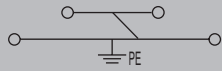

IEC 60947-7-2

Ex e II II 2 G D

IEC	UL	CSA	EN 60079-7
4	AWG 26...10	AWG 26...10	4 mm ²
800			
8			
	480 A (4 mm ²)		
	3		
	A3 / V-0		

CE

Rated connection

0.5...6 / 1.5...6

0.5...4 / 0.5...4

0.5...1 Nm / (M 3)

8 / 0.6 x 3.5 mm

WDK 10 PE

10 mm²

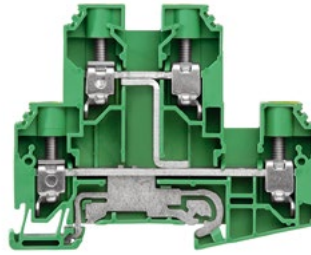

9.9 x 85 x 69
70 / 16
1.5...16

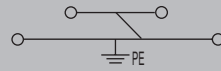

IEC 60947-7-2

IEC	UL	CSA	EN 60079-7
10	AWG 18...6	AWG 18...6	
800			
8			
	1200 A (10 mm ²)		
	3		
	B6 / V-0		

CE

Rated connection

1.5...16 / 1.5...16

1.5...16 / 1.5...16

1.2...1.9 Nm / (M 4)

12 / 1.0 x 5.5 mm

Type	Qty.	Order No.
WDK 4N PE	100	1041920000

Type	Qty.	Order No.
WDK 10 PE	50	1415470000

Type	current	Qty.	Order No.
WAP WDK2.5/4 N		20	1084000000
WEW 35/2		100	1061200000
SDS 0.6X3.5X100		1	9008330000
DEK 5/6 MC NE WS		1000	1609820000
WS 8/6 PLUS MC NE WS		600	1951880000
DEK 5/5 MM WS		800	2007110000
WS 8/5 MM WS		800	2007150000

Type	current	Qty.	Order No.
WQV 10/2	57 A	50	1052560000
WQV 10/10	57 A	20	1052460000
WAP WDK10		20	1186720000
WAP WDK10 BL		20	1186730000
WEW 35/2		100	1061200000
SDS 1.0X5.5X150		1	9008350000
DEK 5/5 MC NE WS		1000	1609801044
WAD 8 MC NE WS		48	1112940000
WAD 8 MC NE GE		48	1112950000

Rail support protective insulation for installation of mounting rail "SH 2" order No. 0494920000 (QTY 10).

Cross-connections, see section "W series accessories".



Screw connection with clamping yoke technology (W-Series)

Fuse terminal blocks

WSI 4

4 mm²

WSI 4

Overload and short-circuit protection



Width/Height/Depth	mm
max. current / max. cond. cross-section	A/mm ²
Max. clamping range	mm ²

8 x 50.7 x 42.5
6.3 / 4
0.5...4



Technical data

Rated data	
Rated voltage to adjoining terminal	V
Rated current	A
for wire cross-section	mm ²
Rated impulse withstand voltage / Pollution severity	
UL 94 flammability rating	
Approvals	

Clamped conductors (H05V/H07V)

Solid / Stranded	mm ²
Flexible / Flexible with ferrule	mm ²
Tightening torque (clamping screw for copper conductors)	
Blade size	

Note

Ordering data

Version	
500 V AC/DC, without LED	
10-36 V AC/DC, with LED	
30-70 V AC/DC, with LED	
60-150 V AC/DC, with LED	
140-250 V AC/DC, with LED	

Note

Accessories

End bracket	dark beige
Screwdriver	With "swifty set" cutting device Standard
G-fuse cartridge, 5 x 20 mm (IEC 60127-2)	0.25 A fast 0.50 A fast 1.00 A fast 2.00 A fast
Identification systems	

IEC 60947-7-3

IEC	UL	CSA	EN 60079-7
500	300 (C)	300 (C)	
6.3	15	15	
4	AWG 30...12	AWG 30...12	
			6 kV / 3
			V-0

CE

Rated connection

0.5...4 / 1.5...4
0.5...4 / 0.5...2.5
0.4 Nm / (M 3)
0.6 x 3.5 mm

Type	Qty.	Order No.
WSI 4	50	1886580000
WSI 4/LD 10-36V AC/DC	50	1886590000
WSI 4/LD 30-70V AC/DC	50	1886560000
WSI 4/LD 60-150V AC/DC	50	1886570000
WSI 4/LD 140-250V AC/DC	50	1886550000

Type	current	Qty.	Order No.
WEW 35/2		100	1061200000
SWIFTY SET		1	9006060000
SDS 0.6X3.5X100		1	9008330000
G 20/0.25A/F		10	0430500000
G 20/0.50A/F		10	0430600000
G 20/1.00A/F		10	0430700000
G 20/2.00A/F		10	0430900000
DEK 5/5 MC NE WS		1000	1609801044
WS 12/6 MC NE WS		600	1609900000

Type	Order No.
WSI 4	1886580000

Arrangement	Applications			
	Only short-circuit protection		Overload and short-circuit protection	
	T _A max.	Nominal values	T _A max.	Nominal values
Individual	63 °C	4.0 W / 6.3 A	34 °C	1.6 W / 6.3 A
In combination	47 °C	2.5 W / 6.3 A	23 °C	1.6 W / 6.3 A

For detailed information on other accessories and application in the online catalogue

WSI 4/2

4 mm²

WSI 4/2

Overload and short-circuit protection

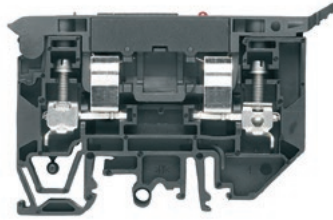

Width/Height/Depth	mm
max. current / max. cond. cross-section	A/mm ²
Max. clamping range	mm ²

9.1 x 81.6 x 53.5
6.3 / 4
0.5...4

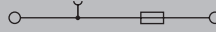

Technical data

Rated data	
Rated voltage to adjoining terminal	V
Rated current	A
for wire cross-section	mm ²
Rated impulse withstand voltage / Pollution severity	
UL 94 flammability rating	
Approvals	
Clamped conductors (H05V/H07V)	
Solid / Stranded	mm ²
Flexible / Flexible with ferrule	mm ²
Tightening torque (clamping screw for copper conductors)	
Blade size	
Note	

IEC 60947-7-3

IEC	UL	CSA	EN 60079-7
500	300 (C)	300 (C)	
6.3	15	15	
4	AWG 30...10	AWG 30...10	
6 kV / 3			
V-0			

CE, RoHS, REACH, etc.

Rated connection	
0.5...6 / 1.5...6	
0.5...6 / 0.5...4	
0.5...0.8 Nm / (M 3)	
0.6 x 3.5 mm	

Width/height/depth = 9.1 x 58.5 x 81.6 mm

Type	Order No.
WSI 4/2	1880430000

Arrangement	Applications			
	Only short-circuit protection		Overload and short-circuit protection	
	T _A max.	Nominal values	T _A max.	Nominal values
Individual	55 °C	4.0 W / 10 A	35 °C	2.5 W / 2.5 A
In combination	68 °C	2.5 W / 2.5 A	41 °C	1.6 W / 1.0 A

Ordering data

Version	
500 V AC/DC, without LED	
10-36 V AC/DC, with LED	
30-70 V AC/DC, with LED	
60-150 V AC/DC, with LED	
140-250 V AC/DC, with LED	
Note	

Type	Qty.	Order No.
WSI 4/2	25	1880430000
WSI 4/2/LD 10-36V AC/DC	25	1880410000
WSI 4/2/LD 30-70V AC/DC	25	1880440000
WSI 4/2/LD 60-150V AC/DC	25	1880420000
WSI 4/2/LD 140-250V AC/DC	25	1880390000

Accessories

End plate / Partition plate	
	dark beige
End bracket	
	dark beige
Screwdriver	
	With "swifty set" cutting device
	Standard
G25 with indicator / imperial (inch) fuse	
	0.50 A medium slow / 2 A
	2.00 A fast / 5 A
	4.00 A fast / 10 A
Identification systems	

Type	current	Qty.	Order No.
WAP WSI4/2		50	1880450000
WEW 35/2		100	1061200000
SWIFTY SET		1	9006060000
SDS 0.6X3.5X100		1	9008330000
GZ 2.0A/F		10	1460600000
GZ 5.0A/F		10	1460620000
GZ 10.0A		10	0293900000
DEK 5/5 MC NE WS		1000	1609801044
WS 12/6 MC NE WS		600	1609900000

For detailed information on other accessories and application in the online catalogue



Screw connection with clamping yoke technology (W-Series)

Fuse terminal blocks

Universal range

A

WSI 6

6 mm²

Metric fuses

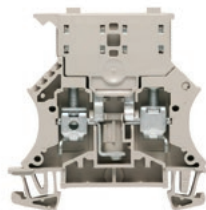

WSI 6

Overload and short-circuit protection

Width/Height/Depth	mm
max. current / max. cond. cross-section	A/mm ²
Max. clamping range	mm ²

7.9 x 60 x 61
6.3 / 10
0.5...10

Technical data

Rated data	
Rated voltage to adjoining terminal	V
Rated current	A
for wire cross-section	mm ²
Rated impulse withstand voltage / Pollution severity	
UL 94 flammability rating	
Approvals	
Clamped conductors (H05V/H07V)	
Solid / Stranded	mm ²
Flexible / Flexible with ferrule	mm ²
Tightening torque (clamping screw for copper conductors)	
Blade size	

IEC 60947-7-3

IEC	UL	CSA	EN 60079-7
500	600 (C)	600 (C)	
6.3	9.5	10	
6	AWG 22...8	AWG 20...8	
6 kV / 3			
V-0			

CE, IEC, UL, CSA, EN, VDE, TÜV

Rated connection	
0.5...10 / 1.5...10	
0.5...10 / 0.5...6	
0.8...1.6 Nm / (M 3.5)	
0.8 x 4.0 mm	

Note

Ordering data

Version	
500 V AC/DC, without LED	
10-36 V AC/DC, with LED	
30-70 V AC/DC, with LED	
60-150 V AC/DC, with LED	
140-250 V AC/DC, with LED	

Note

Type	Qty.	Order No.
WSI 6	50	1011000000

Max. power loss (1.6 W) at the cartridge fuse limits the rated current.

Accessories

Screwable cross-connection	
2-pole	
10-pole	
Lock washer	
Mounting screw	
End plate / Partition plate	
dark beige	
dark beige	
Screwdriver	
End bracket	
dark beige	
G-fuse cartridge, 5 x 20 mm (IEC 60127-2)	
0.25 A fast	
0.50 A fast	
1.00 A fast	
2.00 A fast	
Identification systems	

Type	current	Qty.	Order No.
QL 2 SAK6N	32 A	50	0194300000
QL 10 SAK6N	32 A	20	0338300000
SS M3 D 128-A 3		50	0164400000
KISC M3X5		100	1052100000
WAP 2.5-10		50	1050000000
WAP 16+35 WTW 2.5-10		20	1050100000
SDS 0.8X4.0X100		1	9008340000
WEW 35/2		100	1061200000
G 20/0.25A/F		10	0430500000
G 20/0.50A/F		10	0430600000
G 20/1.00A/F		10	0430700000
G 20/2.00A/F		10	0430900000
DEK 5/8 MC NE WS		800	1856740000
WS 12/6.5 MC NE WS		540	1609920000
DEK 5/8 MM WS		500	2007130000
WS 8/8 MM WS		500	2007170000

For detailed information on other accessories and application in the online catalogue

Markers only fit on one side. Cross-connections, see section "W series accessories".

Type	Order No.
WSI 6	1011000000

Arrangement	Applications			
	Only short-circuit protection		Overload and short-circuit protection	
	T _A max.	Nominal values	T _A max.	Nominal values
Individual	42 °C	4.0 W / 6.3 A	31 °C	1.6 W / 3.0 A
In combination	36 °C	225 W / 6.3 A	27 °C	1.6 W / 3.0 A

Screw connection with clamping yoke technology (W-Series)

Fuse terminal blocks

WSI 6/2

6 mm²

Imperial fuses

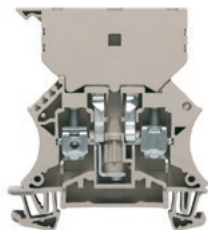

WSI 6/2

Overload and short-circuit protection

Width/Height/Depth	mm
max. current / max. cond. cross-section	A/mm ²
Max. clamping range	mm ²

11.9 x 60 x 66.5
6.3 / 10
0.5...10

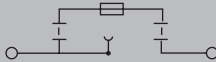

Technical data

Rated data	
Rated voltage to adjoining terminal	V
Rated current	A
for wire cross-section	mm ²
Rated impulse withstand voltage / Pollution severity	
UL 94 flammability rating	
Approvals	

IEC 60947-7-3

IEC	UL	CSA	EN 60079-7
500	600 (C)	150 (C)	
6.3	16	16	
6	AWG 22...8	AWG 20...6	
6 kV / 3			
V-0			

Clamped conductors (H05V/H07V)

Solid / Stranded	mm ²
Flexible / Flexible with ferrule	mm ²
Tightening torque (clamping screw for copper conductors)	
Blade size	

CE TÜV IEC UL

Rated connection	
0.5...10 / 1.5...10	
0.5...10 / 0.5...6	
0.8...1.6 Nm / (M 3.5)	
0.8 x 4.0 mm	

Note

Fuse inserts or contact sleeves should be attached in the middle.

Ordering data

Version	500 V AC/DC, without LED
	10-36 V AC/DC, with LED
	30-70 V AC/DC, with LED
	60-150 V AC/DC, with LED
	140-250 V AC/DC, with LED

Type	Qty.	Order No.
WSI 6/2 GZ/DEF63	25	1014000000

Note

Max. power loss (1.6 W) at the cartridge fuse limits the rated current.

Accessories

Screwable cross-connection	
	2-pole
	10-pole
	Lock washer
	Mounting screw

Type	current	Qty.	Order No.
QL 2 SAK16	76 A	50	0470700000
QL 10 SAK16	76 A	20	0471000000
SS M3 D 128-A 3		50	0164400000
KISC M3X5		100	1052100000

End plate / Partition plate	
	dark beige
	dark beige

WAP 2.5-10	50	1050000000
WAP 16+35 WTW 2.5-10	20	1050100000

G25 with indicator / imperial (inch) fuse	
	0.50 A medium slow / 2 A
	2.00 A fast / 5 A
	4.00 A fast / 10 A

GZ 2.0A	10	0294500000
GZ 5.0A	10	0294600000
GZ 10.0A	10	0293900000

Identification systems

DEK 5/8 MC NE WS	800	1856740000
WS 12/6.5 MC NE WS	540	1609920000

Type	Order No.
WSI 6/2 GZ/DEF63	1014000000

Arrangement	Applications			
	Only short-circuit protection		Overload and short-circuit protection	
	T _A max.	Nominal values	T _A max.	Nominal values
Individual	52 °C	4.0 W / 10.0 A	42 °C	2.5 W / 2.5 A
In combination	62 °C	2.5 W / 2.5 A	30 °C	2.5 W / 2.5 A

For detailed information on other accessories and application in the online catalogue

Markers only fit on one side. Cross-connections, see section "W series accessories".

WSI 6/2 m. LED

6 mm²

Imperial fuses / bipolar LED

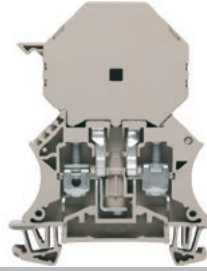

11.9 x 60 x 78.5
6.3 / 10
0.5...10

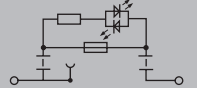

WSI 6/2 m. LED

Overload and short-circuit protection

Width/Height/Depth	mm
max. current / max. cond. cross-section	A/mm ²
Max. clamping range	mm ²

Technical data

Rated data	
Rated voltage to adjoining terminal	V
Rated current	A
for wire cross-section	mm ²
Rated impulse withstand voltage / Pollution severity	
UL 94 flammability rating	
Approvals	
Clamped conductors (H05V/H07V)	
Solid / Stranded	mm ²
Flexible / Flexible with ferrule	mm ²
Tightening torque (clamping screw for copper conductors)	
Blade size	
Note	

IEC 60947-7-3

IEC	UL	CSA	EN 60079-7
500			
6.3			
6	AWG 22...8	AWG 20...6	
	6 kV / 3		
	V-0		

CE

Rated connection	
0.5...10 / 1.5...10	
0.5...10 / 0.5...6	
0.8...1.6 Nm / (M 3.5)	
0.8 x 4.0 mm	
Note	
Fuse inserts or contact sleeves should be attached in the middle.	

Ordering data

Version	
500 V AC/DC, without LED	
10-36 V AC/DC, with LED	
30-70 V AC/DC, with LED	
60-150 V AC/DC, with LED	
140-250 V AC/DC, with LED	
Note	

Type	Qty.	Order No.
WSI 6/2/LD 10-36V DC/AC	25	1014100000
WSI 6/2/LD 30-70V DC/AC	25	1014200000
WSI 6/2/LD 60-150VDC/AC	25	1014300000
WSI 6/2/LD 250AC	25	1014400000
Note		
Max. power loss (1.6 W) at the cartridge fuse limits the rated current.		

Accessories

Screwable cross-connection	
2-pole	
10-pole	
Lock washer	
Mounting screw	
End plate / Partition plate	
dark beige	
dark beige	
G25 with indicator / imperial (inch) fuse	
0.50 A medium slow / 2 A	
2.00 A fast / 5 A	
4.00 A fast / 10 A	
Identification systems	

Type	current	Qty.	Order No.
QL 2 SAK16	76 A	50	0470700000
QL 10 SAK16	76 A	20	0471000000
SS M3 D 128-A 3		50	0164400000
KISC M3X5		100	1052100000
WAP 2.5-10		50	1050000000
WAP 16+35 WTW 2.5-10		20	1050100000
GZ 2.0A		10	0294500000
GZ 5.0A		10	0294600000
GZ 10.0A		10	0293900000
DEK 5/8 MC NE WS		800	1856740000
WS 12/6.5 MC NE WS		540	1609920000

Type	Order No.
WSI 6/2/LD 10-36V DC/AC	1014100000

Arrangement	Applications			
	Only short-circuit protection		Overload and short-circuit protection	
	T _A max.	Nominal values	T _A max.	Nominal values
Individual	52 °C	4.0 W / 10.0 A	42 °C	2.5 W / 2.5 A
In combination	62 °C	2.5 W / 2.5 A	30 °C	2.5 W / 2.5 A

For detailed information on other accessories and application in the online catalogue

Markers only fit on one side. Cross-connections, see section "W series accessories".



WSI 6 LD LLC fused terminal blocks with minimised leakage current

Clearly visible status LED with extremely low leakage current for error indication with an optimal energy balance

Weidmüller has extended its line of screw connect fuse terminals to include the WSI 6 LD LLC and WSI 6/2 LD LLC variants. The terminals have bright status displays which are wired in parallel with the fuse so that, in the event of an outage, the fuse supplies a low leakage current to the LEDs. Since this is undesired current, it is maintained at the lowest level possible. Weidmüller's BFI (Blown Fuse Indicator) circuitry is designed for a reduced leakage current of less than 500 µA. Despite the reduced leakage current, the status displays are still very bright and thus always easy to see.

The leakage current of the bipolar LED circuitry complies with the CSA standard C22.2 No. 39 for fuse holder units and the UL standard 512 for fuse holders.

Fuse is convenient to replace

The fuse holder is easy to access and can pivot, so you can quickly and safely replace a blown fuse.

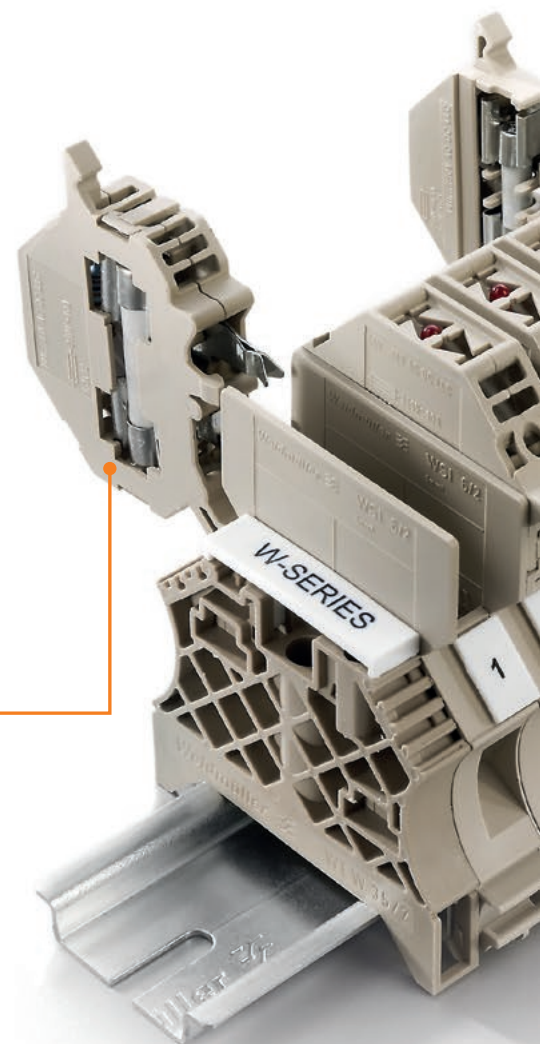
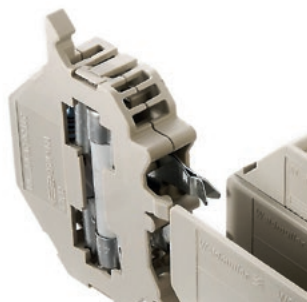

Good cable visibility

Because of the broad width, visibility remains clear and accessible even with many wires connected.

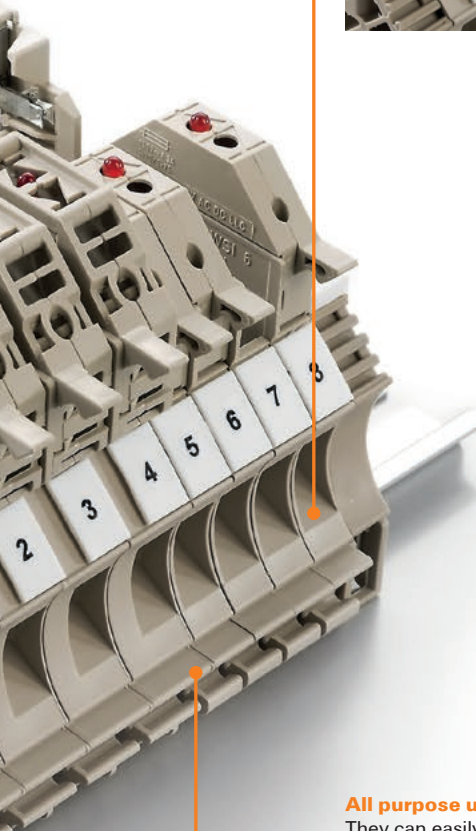

All purpose usage

They can easily be used in applications with larger wire cross sections of up to 10 mm², thanks to their size and the use of larger connection elements.



WSI 6 LD LLC

The WSI-6-LD-LLC variants, with their thin 7.9 mm width, are perfect for use with the 5 x 20 mm fuses.

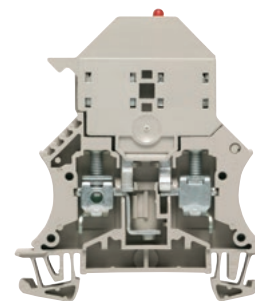

WSI 6/2 LD LLC

The WSI-6/2-LD-LLC variants, with their width of 11.9 mm, are the best solution for use with 1 1/4" x 1/4" fuses.

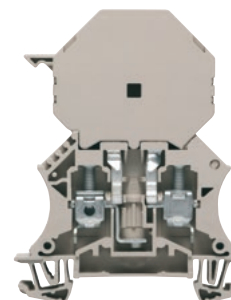

Screw connection with clamping yoke technology (W-Series)

Fuse terminal blocks

WSI 6/LD LLC

6 mm²

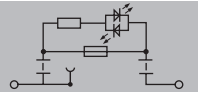
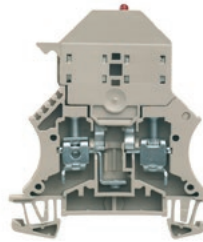

Width/Height/Depth	mm
max. current / max. cond. cross-section	A/mm ²
Max. clamping range	mm ²

7.9 x 60 x 71.5
6.3 / 10
0.5...10

Technical data

Rated data	
Rated voltage to adjoining terminal	V
Rated current	A
for wire cross-section	mm ²
Rated impulse withstand voltage / Pollution severity	
UL 94 flammability rating	
Approvals	
Clamped conductors (H05V/H07V)	
Solid / Stranded	mm ²
Flexible / Flexible with ferrule	mm ²
Tightening torque (clamping screw for copper conductors)	
Blade size	

IEC 60947-7-3

IEC	UL	CSA	EN 60079-7
500			
6.3			
6	AWG 22...8	AWG 20...8	
			/ 3
			V-0



Rated connection	
0.5...10 / 1.5...10	
0.5...10 / 0.5...6	
0.8...1.6 Nm / (M 3.5)	
0.8 x 4.0 mm	

Note

Ordering data

Version	
	10-36 V AC/DC, with LED
	30-70 V AC/DC, with LED
	60-150 V AC/DC, with LED
	140-250 V AC/DC, with LED

Type	Qty.	Order No.
WSI 6/LD 10-36V LLC	50	1119840000
WSI 6/LD 30-70V LLC	50	1119830000
WSI 6/LD 60-150V LLC	50	1119850000
WSI 6/LD 250AC LLC	50	1119870000

Note

Accessories

Screwable cross-connection	
	2-pole
	10-pole
	Mounting screw
End plate / Partition plate	
	dark beige
	dark beige
End bracket	
	dark beige
G-fuse cartridge, 5 x 20 mm (IEC 60127-2)	
	0.25 A fast
	0.50 A fast
	1.00 A fast
	2.00 A fast
Screwdriver	
Identification systems	

Type	current	Qty.	Order No.
QL 2 SAK6N	32 A	50	0194300000
QL 10 SAK6N	32 A	20	0338300000
KISC M3X20 SAK10 CU5		100	0377100000
WAP 2.5-10			
WAP 2.5-10		50	1050000000
WAP 16+35 WTW 2.5-10		20	1050100000
WEW 35/2			
WEW 35/2		100	1061200000
G 20/0.25A/F			
G 20/0.25A/F		10	0430500000
G 20/0.50A/F		10	0430600000
G 20/1.00A/F		10	0430700000
G 20/2.00A/F		10	0430900000
SDS 0.8X4.0X100			
SDS 0.8X4.0X100		1	9008340000
DEK 5/8 MC NE WS			
DEK 5/8 MC NE WS		800	1856740000
WS 12/6.5 MC NE WS			
WS 12/6.5 MC NE WS		540	1609920000
DEK 5/8 MM WS			
DEK 5/8 MM WS		500	2007130000
WS 8/8 MM WS			
WS 8/8 MM WS		500	2007170000

For detailed information on other accessories and application in the online catalogue

Markers only fit on one side. Cross-connections, see section "W series accessories".

WSI 6/2/LD LLC

6 mm²

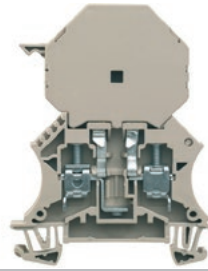

11.9 x 60 x 78.5

6.3 / 10

0.5...10

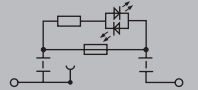

Width/Height/Depth	mm
max. current / max. cond. cross-section	A/mm ²
Max. clamping range	mm ²

Technical data

Rated data	
Rated voltage to adjoining terminal	V
Rated current	A
for wire cross-section	mm ²
Rated impulse withstand voltage / Pollution severity	
UL 94 flammability rating	
Approvals	
Clamped conductors (H05V/H07V)	
Solid / Stranded	mm ²
Flexible / Flexible with ferrule	mm ²
Tightening torque (clamping screw for copper conductors)	
Blade size	

Note

IEC 60947-7-3

IEC	UL	CSA	EN 60079-7
500			
6.3			
6	AWG 22...8	AWG 20...8	
			/ 3
			V-0

Rated connection	
0.5...10 / 1.5...10	
0.5...10 / 0.5...6	
0.8...1.6 Nm / (M 3.5)	
0.8 x 4.0 mm	

Ordering data

Version	
	10-36 V AC/DC, with LED
	30-70 V AC/DC, with LED
	60-150 V AC/DC, with LED
	140-250 V AC/DC, with LED

Note

Type	Qty.	Order No.
WSI 6/2/LD 10-36V LLC	25	1119800000
WSI 6/2/LD 30-70V LLC	25	1119810000
WSI 6/2/LD 60-150V LLC	25	1119820000
WSI 6/2/LD 250AC LLC	25	1119790000

Accessories

Screwable cross-connection	
	2-pole
	10-pole
	Lock washer
	Mounting screw

End plate / Partition plate	dark beige
	dark beige

End bracket	dark beige
--------------------	------------

G25 with indicator / imperial (inch) fuse	
	0.50 A medium slow / 2 A
	2.00 A fast / 5 A
	4.00 A fast / 10 A

Screwdriver

Identification systems

Type	current	Qty.	Order No.
QL 2 SAK16	76 A	50	0470700000
QL 10 SAK16	76 A	20	0471000000
SS M3 D 128-A 3		50	0164400000
KISC M3X5		100	1052100000
WAP			
WAP 2.5-10		50	1050000000
WAP 16*35 WTW 2.5-10		20	1050100000
WEW			
WEW 35/2		100	1061200000
GZ			
GZ 2.0A		10	0294500000
GZ 5.0A		10	0294600000
GZ 10.0A		10	0293900000
SDS			
SDS 0.8X4.0X100		1	9008340000
DEK			
DEK 5/8 MC NE WS		800	1856740000
WS 12/6.5 MC NE WS		540	1609920000

For detailed information on other accessories and application in the online catalogue

Markers only fit on one side. Cross-connections, see section "W series accessories".



Screw connection with clamping yoke technology (W-Series)

Fuse terminal blocks

WSI 25 10x38

25 mm²



WSI 25 CC

25 mm²



Width/Height/Depth	mm	18 x 81 x 58
max. current / max. cond. cross-section	A/mm ²	32 / 25
Max. clamping range	mm ²	1.5...25

Width/Height/Depth	mm	18 x 81 x 58
max. current / max. cond. cross-section	A/mm ²	32 / 25
Max. clamping range	mm ²	1.5...25

Width/Height/Depth	mm	18 x 81 x 58
max. current / max. cond. cross-section	A/mm ²	32 / 25
Max. clamping range	mm ²	1.5...25

Technical data

Rated data	
Rated voltage to adjoining terminal	V
Rated current	A
for wire cross-section	mm ²
Rated impulse withstand voltage / Pollution severity	
UL 94 flammability rating	
Approvals	
Clamped conductors (H05V/H07V)	
Solid / Stranded	mm ²
Flexible / Flexible with ferrule	mm ²
Tightening torque (clamping screw for copper conductors)	
Blade size	

IEC 60947-7-3			
IEC	UL	CSA	EN 60079-7
690		600 (C)	
32		30	
25		AWG 18...3	
		6 kV / 3	
		V-0	
CE			
Rated connection			
1.5...25 / 1.5...25			
1.5...25 / 1.5...25			
2...2.5 Nm /			

IEC 60947-7-3			
IEC	UL	CSA	EN 60079-7
690			
32			
25		AWG 18...3	
		6 kV / 3	
		V-0	
CE			
Rated connection			
1.5...25 / 1.5...25			
1.5...25 / 1.5...25			
2...2.5 Nm /			

Note

Suitable for fuse inserts acc. to IEC 60269-6 with power losses up to 3 W maximum.440 V DC

Suitable for fuse cartridges in accordance with IEC 60269-6 with power losses up to max. 3 W.Suitable for fuse cartridges in accordance with UL 248-4.

Ordering data

Version	
1-pin, without LED	
2-pin, without LED	
3-pin, without LED	
1-pin, with LED	

Type	Qty.	Order No.
WSI 25/1 10x38	12	1966020000
WSI 25/2 10x38	6	1966090000
WSI 25/3 10x38	4	1966080000
WSI 25/1 10x38/LED	12	1966060000

1000 VDC rated voltage tested.

Type	Qty.	Order No.
WSI 25/1 CC	12	1966050000
WSI 25/2 CC	6	1966040000
WSI 25/3 CC	4	1966030000
WSI 25/1 CC/LED	12	1966070000

Note

Accessories

Identification systems	
Marking tags	

Type	current	Qty.	Order No.
ESG 6/15 K MC NE WS		200	1880100000

Type	current	Qty.	Order No.
ESG 6/15 K MC NE WS		200	1880100000

For detailed information on other accessories and application in the online catalogue

Technical drawing

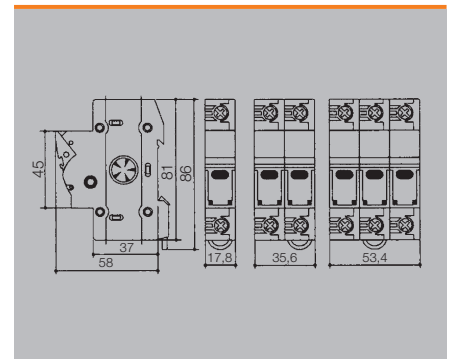
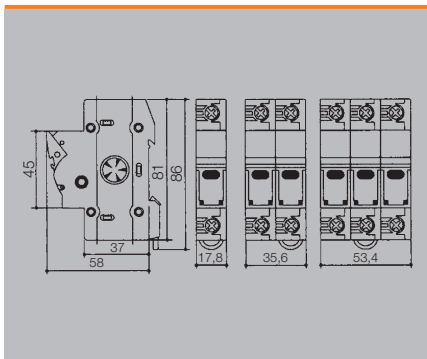

WSI 25/1 10x38 1KV

25 mm²



WSI 25 10x85 1.5 KV

25 mm²



Width/Height/Depth	mm
max. current / max. cond. cross-section	A/mm ²
Max. clamping range	mm ²

18 x 81 x 58
30 / 25
1.5...25

22.5 x 130 x 65
32 / 25
0.75...25

Technical data

Rated data	
Rated voltage to adjoining terminal	V
Rated current	A
for wire cross-section	mm ²
Rated impulse withstand voltage / Pollution severity	
UL 94 flammability rating	
Approvals	
Clamped conductors (H05V/H07V)	
Solid / Stranded	mm ²
Flexible / Flexible with ferrule	mm ²
Tightening torque (clamping screw for copper conductors)	
Blade size	

IEC 60269-1

IEC	UL	CSA	EN 60079-7
1000		600 (C)	
30		30	
25		AWG 18...8	
		6 kV / 3	
		V-0	

IEC 60269-6

IEC	UL	CSA	EN 60079-7
1500			
32			
25			
		6 kV / 3	
		V-0	



Rated connection

1.5...25 / 1.5...25
1.5...25 / 1.5...25
2...2.5 Nm /



Rated connection

/ 1.5...25
0.75...16 / 0.75...16
2...2.5 Nm / (M 5)
Gr. PZ2

Note

Suitable for fuse cartridges to IEC 60269-6 with power loss up to 3 W maximum.

Ordering data

Version	
	1-pin, without LED
	1-pin, with LED

Type	Qty.	Order No.
WSI 25/1 10x38 1KV	12	1137790000
WSI 25/1 10X38/LED 1KV	12	1137780000

Type	Qty.	Order No.
WSI 25 10X85 1.5KV	5	2469360000

Note

Accessories

Safety fuses	
2 A	
4 A	
6 A	
10 A	
12 A	
16 A	
20 A	

Type	current	Qty.	Order No.
FUSE 1KV DC 2A 10/38		10	1224870000
FUSE 1KV DC 4A 10/38		10	1224880000
FUSE 1KV DC 6A 10/38		10	1224890000
FUSE 1KV DC 10A 10/38		10	1224910000
FUSE 1KV DC 12A 10/38		10	1224920000
FUSE 1KV DC 16A 10/38		10	1224930000
FUSE 1KV DC 20A 10/38		10	1224950000

For detailed information on other accessories and application in the online catalogue



Screw connection with clamping yoke technology (W-Series)

Fuse terminal blocks

Universal range

A

SAKS 2/35 DB

10 mm²

D fuses E 16

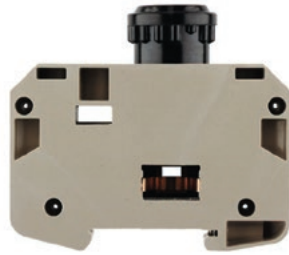

Width/Height/Depth	mm
max. current / max. cond. cross-section	A/mm ²
Max. clamping range	mm ²

27.6 x 80 x 73.5
10 / 16
0.22...16

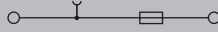

Technical data

Rated data	
Rated voltage to adjoining terminal	V
Rated current	A
for wire cross-section	mm ²
Rated impulse withstand voltage / Pollution severity	
UL 94 flammability rating	
Approvals	
Clamped conductors (H05V/H07V)	
Solid / Stranded	mm ²
Flexible / Flexible with ferrule	mm ²
Tightening torque (clamping screw for copper conductors)	
Blade size	
Note	

Ordering data

Version	
	500 V AC/DC, without LED
Note	

Accessories

Screwable cross-connection	
	2-pole
	10-pole
	Lock washer
	Mounting screw
End plate / Partition plate	
	dark beige
Screw cover cap	
	SK
Fuse cartridges	
Gauge rings	
Identification systems	

For detailed information on other accessories and application in the online catalogue

SAKS 4/35 DB

10 mm²

D 01 fuses E 14



24 x 75 x 65
16 / 16
0.22...16

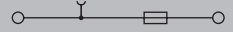

IEC 60947-7-3

IEC	UL	CSA	EN 60079-7
400	600 (C)	600 (C)	
16	30	30	
10	AWG 26...8	AWG 22...8	
6 kV / 3			
V-0, 5VA			
Rated connection			
0.5...16 / 0.5...10			
0.5...10 / 0.5...10			
1.2...2.4 Nm / (M 4)			
1.0 x 5.5 mm			
Note			
400 V also with Neozed marine engineering fuse. On connection of over 10 mm ² stranded and 7-wire AWG conductors, the tightening torque is 2 Nm.			

Type	Qty.	Order No.
SAKS 4/35 DB	20	0501800000
Material Duroplast KRG		

Type	current	Qty.	Order No.
QL 2 SAKS4	36 A	20	0328000000
QL 10 SAKS4	36 A	20	0339000000
SS M4 D 128-A 4		100	0136400000
BFSC M4X9T		100	0103300000
WTW EN		20	1058800000
SK E14 SAKS4		20	0339410000
E 14/2A RS		10	0137400000
E 14/4A BR		10	0137500000
E 14/6A GN		10	0328300000
E 14/10A RT		10	0328400000
P 14/2 D01 RS SAKS4		50	0138000000
P 14/4 D01 BR SAKS4		50	0138100000
DEK 5/5 MC NE WS		1000	1609801044

Replacement screw cover cap, order no. 0284110000 (QTY 20) Cross-connections, see section "W series accessories".

Replacement screw cover cap, order no. 0339410000 (QTY 20) Cross-connections, see section "W series accessories".

SAKS 5/35 DB

16 mm²

D 02 fuse E 18



Width/Height/Depth	mm
max. current / max. cond. cross-section	A/mm ²
Max. clamping range	mm ²

28 x 80 x 65
63 / 16
1.5...16

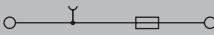

Technical data

Rated data	
Rated voltage to adjoining terminal	V
Rated current	A
for wire cross-section	mm ²
Rated impulse withstand voltage / Pollution severity	
UL 94 flammability rating	
Approvals	
Clamped conductors (H05V/H07V)	
Solid / Stranded	mm ²
Flexible / Flexible with ferrule	mm ²
Tightening torque (clamping screw for copper conductors)	
Blade size	

IEC 60947-7-3

IEC	UL	CSA	EN 60079-7
400	600 (C)	600 (C)	
63	40	63	
16	AWG 14...6	AWG 14...6	
6 kV / 3			
V-0, 5VA			

CE, UKCA, ENEC, IEC, VDE, UL, CSA

Rated connection	
1.5...16 / 1.5...16	
1.5...16 / 1.5...16	
1.2...2.4 Nm / (M 4)	
1.0 x 5.5 mm	

Note

400 V also with Neozed marine engineering fuse. On connection of over 10 mm² stranded and 7-wire AWG conductors, the tightening torque is 2 Nm.

Ordering data

Version	500 V AC/DC, without LED
Note	

Type	Qty.	Order No.
SAKS 5/35 DB	20	0502100000
Material Duroplast KRG		

Accessories

Screwable cross-connection	
2-pole	
10-pole	
Lock washer	
Mounting screw	
End plate / Partition plate	
dark beige	
Screw cover cap	
SK	
Fuse cartridges	
Gauge rings	
Identification systems	

Type	current	Qty.	Order No.
QL 2 SAKS2	36 A	20	0207800000
QL 10 SAKS2	36 A	20	0338900000
SS M4 D 128-A 4		100	0136400000
BFSC M4X9T		100	0103300000
WTW EN		20	1058800000
SK E18 SAKS5		20	0359310000
E 18/20A BL		10	0361300000
E 18/25A GE		10	0361400000
E 18/35A SW		10	0361500000
P 18/20 D02 BL SAKS5		50	0361800000
P 18/25 D02 GE SAKS5		50	0361900000
P 18/35 D02 SW SAKS5		50	0362000000
P 18/50 D02 WS SAKS5		50	0362100000
DEK 5/5 MC NE WS		1000	1609801044

For detailed information on other accessories and application in the online catalogue

Replacement screw cover cap, order no. 0359310000 (QTY 20) Cross-connections, see section "W series accessories".



Screw connection with clamping yoke technology (W-Series)

Fuse terminal blocks

Universal range

A

WTR 2.5/SI

2.5 mm²



WTR 4/SI

4 mm²



Width/Height/Depth	mm
max. current / max. cond. cross-section	A/mm ²
Max. clamping range	mm ²

5.1 x 60 x 97	
6.3 / 4	
0.05...4	

6.1 x 60 x 97	
6.3 / 6	
0.22...6	

Technical data

Rated data	
Rated voltage to adjoining terminal	V
Rated current	A
for wire cross-section	mm ²
Rated impulse withstand voltage / Pollution severity	
UL 94 flammability rating	
Approvals	
Clamped conductors (H05V/H07V)	
Solid / Stranded	mm ²
Flexible / Flexible with ferrule	mm ²
Tightening torque (clamping screw for copper conductors)	
Blade size	

IEC 60947-7-3

IEC	UL	CSA	EN 60079-7
400		300 (D)	
6.3		10	
2.5	AWG 22...12	AWG 26...12	
6 kV / 3			
V-0			

CE

Rated connection	
0.5...4 / 1.5...4	
0.5...4 / 0.5...2.5	
0.4...0.8 Nm / (M 2.5)	
0.6 x 3.5 mm	

IEC 60947-7-3

IEC	UL	CSA	EN 60079-7
400	300 (D)	300 (C)	
6.3	6.3	6.3	
4	AWG 22...10	AWG 22...10	
6 kV / 3			
V-0			

Rated connection	
0.5...6 / 1.5...6	
0.5...4 / 0.5...4	
0.5...0.6 Nm / (M 3)	
0.6 x 3.5 mm	

Note

2.5 mm² conductor with ferrule with plastic collar, with the collar optimised for diameter only (order No. 1333100000, QTY 500).

The rated current of the terminal is determined by the max. power loss of 1.6 W at the cartridge fuse.

Ordering data

Version	
400 V AC/DC, without LED	
10-36 V AC/DC, with LED	
30-70 V AC/DC, with LED	
60-150 V AC/DC, with LED	
140-250 V AC/DC, with LED	

Note

Type	Qty.	Order No.
WTR 2.5/SI	25	1763940000
WTR 2.5/SI LD 36V	25	1763950000

UL/CSA specified for cartridge fuse 400 V; otherwise, the specified voltage range also applies to UL/CSA.

Type	Qty.	Order No.
WTR 4 SI	25	7910240000
WTR 4/SI LD 36V	25	7914370000
WTR 4/SI LD 70V	25	7914380000
WTR 4/SI LD 150V	25	7914390000
WTR 4/SI LD 250V	25	7914400000

UL/CSA specified for cartridge fuse 400 V; otherwise, the specified voltage range also applies to UL/CSA.

Accessories

Pluggable cross-connection	
2-pole	
10-pole	
2-pole, yellow	
10-pole	
End plate / Partition plate	
dark beige	
dark beige	
G-fuse cartridge, 5 x 20 mm (IEC 60127-2)	
0.25 A fast	
0.50 A fast	
1.00 A fast	
2.00 A fast	
Screwdriver	
Standard	
Identification systems	

Type	current	Qty.	Order No.
ZQV 2.5N/2	24 A	60	1527540000
ZQV 2.5N/10	24 A	20	1527690000
WAP 2.5-10			
WAP 2.5-10		50	1050000000
WAP 16+35 WTW 2.5-10		20	1050100000
G 20/0.25A/F			
G 20/0.25A/F		10	0430500000
G 20/0.50A/F		10	0430600000
G 20/1.00A/F		10	0430700000
G 20/2.00A/F		10	0430900000
SDS 0.6X3.5X100			
SDS 0.6X3.5X100		1	9008330000
DEK 5/5 MC NE WS			
DEK 5/5 MC NE WS		1000	1609801044
WS 12/5 MC NE WS			
WS 12/5 MC NE WS		720	1609860000
DEK 5/5 MM WS			
DEK 5/5 MM WS		800	2007110000
WS 8/5 MM WS			
WS 8/5 MM WS		800	2007150000

Type	current	Qty.	Order No.
ZQV 4N/2 GE	32 A	60	1758250000
ZQV 4N/10 GE	32 A	20	1758260000
WAP 2.5-10			
WAP 2.5-10		50	1050000000
WAP 16+35 WTW 2.5-10		20	1050100000
G 20/0.25A/F			
G 20/0.25A/F		10	0430500000
G 20/0.50A/F		10	0430600000
G 20/1.00A/F		10	0430700000
G 20/2.00A/F		10	0430900000
SDS 0.6X3.5X100			
SDS 0.6X3.5X100		1	9008330000
DEK 5/6 MC NE WS			
DEK 5/6 MC NE WS		1000	1609820000
WS 12/6 MC NE WS			
WS 12/6 MC NE WS		600	1609900000
DEK 5/6 MM WS			
DEK 5/6 MM WS		600	2007120000
WS 8/6 MM WS			
WS 8/6 MM WS		600	2007160000

For detailed information on other accessories and application in the online catalogue

Cross-connection options for WTR 2.5, see section on W-series Accessories.

Cross-connections, see section "W series accessories".

WTR 4 SI SL

4 mm²

With fuse holder

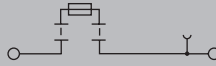
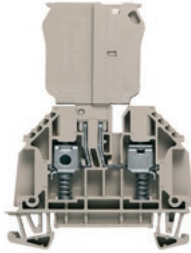

Width/Height/Depth	mm
max. current / max. cond. cross-section	A/mm ²
Max. clamping range	mm ²

6.1 x 61.5 x 97
6.3 / 6
0.22...6

Technical data

Rated data	
Rated voltage to adjoining terminal	V
Rated current	A
for wire cross-section	mm ²
Rated impulse withstand voltage / Pollution severity	
UL 94 flammability rating	
Approvals	
Clamped conductors (H05V/H07V)	
Solid / Stranded	mm ²
Flexible / Flexible with ferrule	mm ²
Tightening torque (clamping screw for copper conductors)	
Blade size	

IEC 60947-7-1

IEC	UL	CSA	EN 60079-7
400	300 (D)	300 (D)	
6.3	6.3	6.3	
4	AWG 22...10	AWG 22...10	
6 kV / 3			
V-0			

IEC ENE CCC CSA

Rated connection	
0.5...6 / 1.5...6	
0.5...4 / 0.5...4	
0.5...1 Nm / (M 3)	
0.6 x 3.5 mm	

Note

Ordering data

Version	400 V AC/DC, without LED
Note	

Type	Qty.	Order No.
WTR 4 SI SL	25	7910330000

Accessories

Pluggable cross-connection	2-pole 10-pole
End plate / Partition plate	dark beige Black dark beige
End bracket	dark beige
Hak. Cable lugs	
Identification systems	

Type	current	Qty.	Order No.
ZQV 4N/2	32 A	60	1527930000
ZQV 4N/10	32 A	20	1528090000
WAP 2.5-10			
WAP 2.5-10		50	1050000000
WAP 2.5-10 SW		50	1050010000
WAP 16*35 WTW 2.5-10		20	1050100000
WEW 35/2			
WEW 35/2		100	1061200000
HBT 1,5 - 3,0 RT			
HBT 1,5 - 3,0 RT		100	1312440000
HBT 2,5 - 3,0 BL			
HBT 2,5 - 3,0 BL		100	1312450000
DEK 5/6 MC NE WS			
DEK 5/6 MC NE WS		1000	1609820000
WS 12/6 MC NE WS			
WS 12/6 MC NE WS		600	1609900000
DEK 5/6 MM WS			
DEK 5/6 MM WS		600	2007120000
WS 8/6 MM WS			
WS 8/6 MM WS		600	2007160000

For detailed information on other accessories and application in the online catalogue

Cross-connections, see section "W series accessories".



Screw connection with clamping yoke technology (W-Series)

Fuse terminal blocks

Universal range

A

KDKS 1/35 DB

4 mm²

Metric fuses 5 x 20 mm

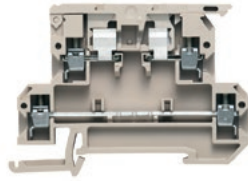

KDKS 1EN/LLC

4 mm²

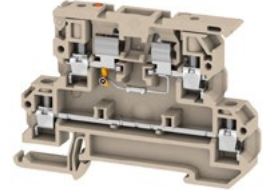

Width/Height/Depth	mm
max. current / max. cond. cross-section	A/mm ²
Max. clamping range	mm ²

8 x 73.5 x 55.6	
6.3 / 4	
0.22...4	

8 x 76.5 x 54.6	

Technical data

Rated data	
Rated voltage to adjoining terminal	V
Rated current	A
for wire cross-section	mm ²
Rated impulse withstand voltage / Pollution severity	
UL 94 flammability rating	
Approvals	
Clamped conductors (H05V/H07V)	
Solid / Stranded	mm ²
Flexible / Flexible with ferrule	mm ²
Tightening torque (clamping screw for copper conductors)	
Blade size	
Note	

IEC 60947-7-3

IEC	UL	CSA	EN 60079-7
500	300 (C)	300 (D)	
6.3	10	10	
4	AWG 26...12	AWG 26...12	
			6 kV / 3
			V-0

CE

Rated connection	
Solid / Stranded	mm ²
Flexible / Flexible with ferrule	mm ²
Tightening torque (clamping screw for copper conductors)	
Blade size	

Note: max. conductor size = 2.5 mm² when using the cross-connector.

IEC	UL	CSA	EN 60079-7
500	300 (C)	150 (C)	
6.3	20	25	
4	AWG 26...12	AWG 26...12	
			/ 3
			V-0

Rated connection	
Solid / Stranded	mm ²
Flexible / Flexible with ferrule	mm ²
Tightening torque (clamping screw for copper conductors)	
Blade size	

Ordering data

Version	
500 V AC/DC, without LED	
10-36 V AC/DC, with LED	
30-70 V AC/DC, with LED	
60-150 V AC/DC, with LED	
100-250 V AC/DC, with LED	
Note	

Type	Qty.	Order No.
KDKS 1/35 DB	50	9532440000

Max. power loss (1.6 W) at the cartridge fuse limits the rated current.

Type	Qty.	Order No.
KDKS 1EN/LLC 10-36V AC/DC	50	9802720001
KDKS 1EN/LLC 30-70V AC/DC	50	9908510001
KDKS 1EN/LLC 100-250V AC/DC	50	9915820001

Accessories

End plate / Partition plate	
dark beige	
G-fuse cartridge, 5 x 20 mm (IEC 60127-2)	
0.25 A fast	
0.50 A fast	
1.00 A fast	
2.00 A fast	
Identification systems	

Type	current	Qty.	Order No.
AP KDKS1 DB		20	9532470000
G 20/0.25A/F		10	0430500000
G 20/0.50A/F		10	0430600000
G 20/1.00A/F		10	0430700000
G 20/2.00A/F		10	0430900000
DEK 5/8 MC NE WS		800	1856740000

Type	current	Qty.	Order No.
AP KDKS1 DB		20	9532470000
G 20/0.25A/F		10	0430500000
G 20/0.50A/F		10	0430600000
G 20/1.00A/F		10	0430700000
G 20/2.00A/F		10	0430900000
DEK 5/8 MC NE WS		800	1856740000

For detailed information on other accessories and application in the online catalogue

KDKS 1PE/LLC

4 mm²

KDKS 1/35 DB

Overload and short-circuit protection

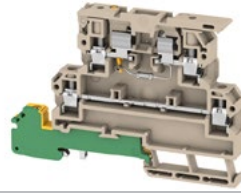

Width/Height/Depth	mm
max. current / max. cond. cross-section	-/mm ²
Max. clamping range	mm ²

8 x 91 x 65	
/ 4	
0.33...4	

IEC 60947-7-1, IEC 60947-7-2, IEC 60947-7-3

Technical data

Rated data	
Rated voltage to adjoining terminal	V
Rated current	A
for wire cross-section	mm ²
Rated impulse withstand voltage / Pollution severity	
UL 94 flammability rating	
Approvals	
Clamped conductors (H05V/H07V)	
Solid / Stranded	mm ²
Flexible / Flexible with ferrule	mm ²
Tightening torque (clamping screw for copper conductors)	
Blade size	
Note	

IEC	UL	CSA	EN 60079-7
500	300 (C)	150 (C)	
6.3	20	25	
4	AWG 26...12	AWG 26...12	
6 kV / 3			
V-0			

® VDE	
Rated connection	
0.5...4 / 1.5...4	
0.5...4 / 0.5...4	
0.5...1 Nm / (M 3)	
0.6 x 3.5 mm	
Note	

Ordering data

Version	
500 V AC/DC, without LED	
10-36 V AC/DC, with LED	
30-70 V AC/DC, with LED	
60-150 V AC/DC, with LED	
100-250 V AC/DC, with LED	
Note	

Type	Qty.	Order No.
KDKS 1PE/LLC 10-36V AC/DC	50	1518300000
KDKS 1PE/LLC 30-70V AC/DC	50	1518330000
KDKS 1PE/LLC 60-150V AC/DC	50	1518340000
KDKS 1PE/LLC 100-250V AC/DC	50	1518370000
Note		

Accessories

End plate / Partition plate	
dark beige	
G-fuse cartridge, 5 x 20 mm (IEC 60127-2)	
0.25 A fast	
0.50 A fast	
1.00 A fast	
2.00 A fast	
Identification systems	

Type	current	Qty.	Order No.
AP KDKS1 DB		20	9532470000
G 20/0.25A/F		10	0430500000
G 20/0.50A/F		10	0430600000
G 20/1.00A/F		10	0430700000
G 20/2.00A/F		10	0430900000
DEK 5/8 MC NE WS		800	1856740000
Note			

Type	Order No.
KDKS 1/35 DB	9532440000
Note	

Arrangement	Applications			
	Only short-circuit protection		Overload	
	T _A max.	Nominal values	T _A max.	Nominal values
Individual	23 °C*	4.0 W / 10 A*	41 °C	1.6 W / 6.3 A
In combination	50 °C*	1.6 W / 6.3 A	23 °C	1.6 W / 6.3 A

*) Values not available → The values specified were not measured but instead read from the derating curves and transferred to the "only short-circuit protection" operating mode.

For detailed information on other accessories and application in the online catalogue



Fuse cartridges

Technical data

for terminal type:
 PSI 6/10
 WSI 4
 WSI 6
 AFS 4 2C BK
 PSI 6/10 SW
 ZSI 2.5
 ZSI 2.5-2/2X2AN/G20
 ZSI 6-2 2X2.5/G20
 KDKS 1/35 DB



Ordering data

G-type fuse cartridges 5 x 20 without indicator in accordance with IEC 60127-2 (VDE 0820 T.2 B1) ¹⁾						
Size (mm)	Rated current	Characteristics	Type	Qty.	Order No.	
	0.1	quick-acting	G 20/0.10A/F	10	0430300000	
	0.2	quick-acting	G 20/0.20A/F	10	0430400000	
Cartridge fuse	G-Si. 5 x 20	0.25	quick-acting	G 20/0.25A/F	10	0430500000
Rated breaking capacity	1.5 kA	0.5	quick-acting	G 20/0.50A/F	10	0430600000
	0.63	quick-acting	G 20/0.63A/F	10	0439000000	
	1	quick-acting	G 20/1.00A/F	10	0430700000	
	1.6	quick-acting	G 20/1.60A/F	10	0430800000	
	2	quick-acting	G 20/2.00A/F	10	0430900000	
	2.5	quick-acting	G 20/2.50A/F	10	0431000000	
	3.15	quick-acting	G 20/3.15A/F	10	0431100000	
	4	quick-acting	G 20/4.00A/F	10	0431200000	
	5	quick-acting	G 20/5.00A/F	10	0431300000	
	6.3	quick-acting	G 20/6.30A/F	10	0431400000	

(M) = medium time-lag; (F) = quick-acting

Technical data

for terminal type:
 WSI 6



Ordering data

G-type fuse cartridges 5 x 25 with code in acc. with DIN 41576 ¹⁾						
Size (mm)	Rated current	Characteristics	Type	Qty.	Order No.	
	0.25	medium time-lag	G 25/0.25A/M GE	10	0546900000	
	0.5	medium time-lag	G 25/0.50A/M WS	10	0510300000	
Cartridge fuse	G-Si. 5 x 25	0.8	medium time-lag	G 25/0.80A/M GR	10	0646400000
Rated breaking capacity	80 A	1	medium time-lag	G 25/1.00A/M RT	10	0265800000
	2	quick-acting	G 25/2.00A/F BL	10	0192700000	
	4	quick-acting	G 25/4.00A/F BR	10	0192800000	
	6.3	quick-acting	G 25/6.30A/F GN	10	0192900000	
	10	medium time-lag	G 25/10.0A/M RT	10	0193100000	

(M) = medium time-lag; (F) = quick-acting

Technical data

for terminal type:
 WSI 4/2
 WSI 6/2 GZ/DEF63



Ordering data

Fuse cartridges 1¼" x ¼" without indicator in acc. with BS 88						
Size (mm)	Rated current	Characteristics	Type	Qty.	Order No.	
	0.5	quick-acting	GZ 0.5A/F	10	1460580000	
	1	quick-acting	GZ 1.0A/F	10	1460590000	
Cartridge fuse	G-Si. 6.3 x 32	2	quick-acting	GZ 2.0A/F	10	1460600000
Rated breaking capacity	50 kA	3	quick-acting	GZ 3.0A/F	10	1460610000
	5	quick-acting	GZ 5.0A/F	10	1460620000	
	7	quick-acting	GZ 7.0A/F	10	1460630000	
	10	quick-acting	GZ 10.0A/F	10	1460640000	
	12.5	quick-acting	GZ 12.5A/F	10	1460650000	

(M) = medium time-lag; (F) = quick-acting

Technical data

for terminal type:
 SAKS 2/35 DB



Ordering data

D-type fuse cartridge E 16 with indicator in acc. with DIN 49360 (Diazed)					
Size (mm)	Rated current	Characteristics	Type	Qty.	Order No.
	10		E 16/10A RT TNDZ	25	0208500000
	16		E 16/16A GR TNDZ	25	0208600000
Cartridge fuse			E 16/20A BL TNDZ	25	0208700000
Rated breaking capacity	25		E 16/25A GE TNDZ	25	0208800000

(M) = medium time-lag; (F) = quick-acting

Technical data

for terminal type:
 SAKS 4/35 DB



Ordering data

D-type fuse cartridges E 14 size D 01 and E 18 size D 02 with indicator in acc. with DIN 49522 (Neozed) ³⁾					
Size (mm)	Rated current	Characteristics	Type	Qty.	Order No.
	10		E 14/10A RT	10	0328400000
	16		E 14/16A GR	10	0328500000
Cartridge fuse			E 14/2A RS	10	0137400000
Rated breaking capacity			E 14/4A BR	10	0137500000
	6		E 14/6A GN	10	0328300000

(M) = medium time-lag; (F) = quick-acting

Fuse cartridges

Technical data

for terminal type:
SAKS 5/35 DB



Ordering data

D-type fuse cartridges E 14 size D 01 and E 18 size D 02 with indicator in acc. with DIN 49522 (Neozed)³⁾

Size (mm)	Rated current	Characteristics	Type	Qty.	Order No.
	20		E 18/20A BL	10	0361300000
	25		E 18/25A GE	10	0361400000
Cartridge fuse	35		E 18/35A SW	10	0361500000
Rated breaking capacity	50		E 18/50A WS	10	0361600000
	63		E 18/63A KU	10	0361700000

(M) = medium time-lag; (F) = quick-acting

- 1) The company SIBA supplies G-type fuse cartridges 5 x 25 with indicator, also in marine engineering version for 450 V~.
- 2) Fuse cartridges 5 x 30 (500 V~) für SAKS 3 are available from the company WICKMANN.
- 3) The company LINDNER supplies Neozed fuse cartridges, also in a further marine engineering version for 440 V~.
- 4) Fuse cartridges with the dimensions 1"x1/4" = 25.4x6.35 mm and 13/32"x11/2" = 10.3x38.1 mm are not in the programme.
- 5) Only for SAKS 1 and SAKS 7.

Safety fuse 10x38 mm

In photovoltaic applications, fusing of individual strings is needed. Specially designed fuses should be used as DC voltages and current are involved. AC fuses are not suitable. The range from 2-20 A and up to 1000 V DC can be covered with safety fuses, size 10 x 38 mm.



Ordering data

Type	Qty.	Order No.
FUSE 1KV DC 2A 10/38	10	1224870000
FUSE 1KV DC 4A 10/38	10	1224880000
FUSE 1KV DC 6A 10/38	10	1224890000
FUSE 1KV DC 10A 10/38	10	1224910000
FUSE 1KV DC 12A 10/38	10	1224920000
FUSE 1KV DC 16A 10/38	10	1224930000
FUSE 1KV DC 20A 10/38	10	1224950000

Note

Gauge rings

Technical data

for terminal type:
SAKS 4/35 DB



Ordering data

Type	Cartridge fuse	Current	Colour	Qty.	Order No.
P 14/2 D01 RS SAKS4	E14 / 2	2 A	Pink	50	0138000000
P 14/4 D01 BR SAKS4	E14 / 4	4 A	Brown	50	0138100000
P 14/6 D01 GN SAKS4	E14 / 6	6 A	Green	50	0328600000
P 14/10 D01 RT SAKS4	E14 / 10	10 A	Red	50	0328700000

Technical data

for terminal type:
SAKS 5/35 DB



Ordering data

Type	Cartridge fuse	Current	Colour	Qty.	Order No.
P 18/20 D02 BL SAKS5	E18 / 20	20 A	Blue	50	0361800000
P 18/25 D02 GE SAKS5	E18 / 25	25 A	Yellow	50	0361900000
P 18/35 D02 SW SAKS5	E18 / 35	35 A	Black	50	0362000000
P 18/50 D02 WS SAKS5	E18 / 50	50 A	White	50	0362100000

Screw connection with clamping yoke technology (W-Series)

Test-disconnect terminal blocks

WTR 2.5

2.5 mm²

With clamping screw

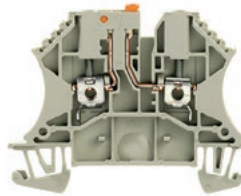

Width/Height/Depth	mm
max. current / max. cond. cross-section	A/mm ²
Max. clamping range	mm ²

5.1 x 60 x 48
24 / 4
0.05...4

Technical data

Rated data	
Rated voltage of feed-through terminal	V
Rated current	A
for wire cross-section	mm ²
Rated impulse withstand voltage / Pollution severity	
Gauge to IEC 60947-1 / UL 94 flammability rating	
Number of operating cycles	
Approvals	
Clamped conductors (H05V/H07V)	
Solid / Stranded	mm ²
Flexible / Flexible with ferrule	mm ²
Tightening torque (clamping screw for copper conductors)	
Stripping length / Blade size	mm/-
Note	

IEC 60947-7-1

IEC	UL	CSA	EN 60079-7
500	600	300	
24	20	10	
2.5	AWG 30...12	AWG 26...12	
6 kV / 3			
A3 / V-0			

CE CB CB CB CB

Rated connection	
0.5...4 / 1.5...4	
0.5...4 / 0.5...2.5	
0.4...0.8 Nm / (M 2.5)	
10 / 0.6 x 3.5 mm	

2.5 mm² conductor with ferrule with plastic collar, only with order No. 1333100000 (QTY 500).

Ordering data

Version	
	dark beige
	blue
	without isolator, dark beige
Note	

Accessories

Pluggable cross-connection	
	2-pole
	10-pole
	2-pole
	10-pole
	2-pole, yellow
End plate / Partition plate	
	dark beige
	dark beige
End bracket	
	dark beige
Holder for cartridge fuse 5 x 20 mm	
	400 V AC/DC, without LED
	10 - 36 V AC/DC, red LED
	140 - 250 V AC/DC, red LED
Module connector (max. 250 V)	
	without fittings
	with wire jumper
	With 1N4007 diode
Disconnect plug	
	removable, as replacement for release lever
Screwdriver	
	Standard
Testing / Checking	
	Test plug
Identification systems	
	DEK 5/5 MC NE WS
	WS 12/5 MC NE WS
	WS 8/5 MM WS
	DEK 5/5 MM WS
For detailed information on other accessories and application in the online catalogue	

Type	Qty.	Order No.
WTR 2.5	100	1855610000
WTR 2.5 BL	100	8731640000
WTR 2.5/0.TNHE	100	8731700000

Type	current	Qty.	Order No.
ZQV 2.5N/2	24 A	60	1527540000
ZQV 2.5N/10	24 A	20	1527690000
WAP 2.5-10		50	1050000000
WEW 35/2		100	1061200000
SIHA 3/G20		25	7921560000
SIHA 3/G20/LD 10-36V		25	7921570000
SIHA 3/G20/LD 140-250V		25	7921600000
BEST		50	1833100000
BEST/DRBR		50	1878570000
BEST/D		50	1878560000
TNST		50	1833090000
SDS 0.6X3.5X100		1	9008330000
DEK 5/5 MC NE WS		1000	1609801044
WS 12/5 MC NE WS		720	1609860000
WS 8/5 MM WS		800	2007150000
DEK 5/5 MM WS		800	2007110000
Cross-connections, see section "W series accessories".			

WTR 2.5 STB

2.5 mm²

With sockets



5.1 x 60 x 48
24 / 4
0.05...4

IEC 60947-7-1

IEC	UL	CSA	EN 60079-7
500	300	300	
24	20	10	
2.5	AWG 30...12	AWG 26...12	
6 kV / 3			
A3 / V-0			

CE CB CB CB CB

Rated connection	
0.5...4 / 1.5...4	
0.5...4 / 0.5...2.5	
0.4...0.8 Nm / (M 3)	
10 / 0.6 x 3.5 mm	

2.5 mm² conductor with ferrule with plastic collar, only with order No. 1333100000 (QTY 500).

Type	Qty.	Order No.
WTR 2.5 STB2.3	100	1527540000
WTR 2.5 STB2.3 BL	100	8731660000
WTR 2.5/0.TNHE STB2.3	100	8731670000

Type	current	Qty.	Order No.
ZQV 2.5N/2	24 A	60	1527540000
ZQV 2.5N/10	24 A	20	1527690000
WAP 2.5-10		50	1050000000
WEW 35/2		100	1061200000
SIHA 3/G20		25	7921560000
SIHA 3/G20/LD 10-36V		25	7921570000
SIHA 3/G20/LD 140-250V		25	7921600000
BEST		50	1833100000
BEST/DRBR		50	1878570000
BEST/D		50	1878560000
TNST		50	1833090000
SDS 0.6X3.5X100		1	9008330000
PS 2.3 RT		20	0180400000
DEK 5/5 MC NE WS		1000	1609801044
WS 12/5 MC NE WS		720	1609860000
WS 8/5 MM WS		800	2007150000
DEK 5/5 MM WS		800	2007110000
Special cross-connector, see section on W-series accessories.			

WTR 2.5/ZZ

2.5 mm²

Twin connection

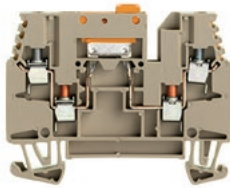

5.1 x 60 x 46.5
14 / 4
0.13...4



IEC	UL	CSA	EN 60079-7
400	300	300	
14	10	10	
2.5	AWG 26...12	AWG 26...12	
6 kV / 3			
A3 / V-0			

CE ENEK

Rated connection

0.5...4 / 1.5...4
0.5...4 / 0.5...2.5
0.5...1 Nm / (M 3)
7 / 0.6 x 3.5 mm

WTR 4

4 mm²

With clamping screw

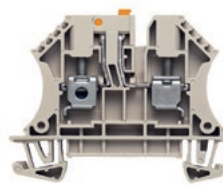

6.1 x 60 x 48
32 / 6
0.22...6

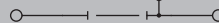

IEC	UL	CSA	EN 60079-7
400	300	300	
32	10	10	
4	AWG 22...10	AWG 22...10	
6 kV / 3			
A4 / V-0			

CE ENEK

Rated connection

0.5...6 / 1.5...6
0.5...4 / 0.5...4
0.5...0.6 Nm / (M 3)
13 / 0.6 x 3.5 mm

WTR 4 STB

4 mm²

With socket

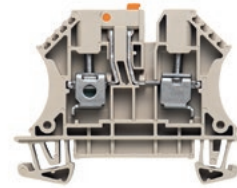

6.1 x 60 x 48
32 / 6
0.22...6



IEC	UL	CSA	EN 60079-7
400	300	300	
32	10	10	
4	AWG 22...10	AWG 22...10	
6 kV / 3			
A4 / V-0			

CE ENEK

Rated connection

0.5...6 / 1.5...6
0.5...4 / 0.5...4
0.5...0.6 Nm / (M 3)
13 / 0.6 x 3.5 mm

Type	Qty.	Order No.
WTR 2.5/ZZ	100	1039900000
WTR 2.5/ZZ BL	100	1039980000
WTR 2.5/ZZ 0.TNHE	100	1774670000

2.5 mm² conductor with ferrule with plastic collar, with collar optimised for diameter only (order No. 1333100000, QTY 500).

Type	Qty.	Order No.
WTR 4	50	7910180000
WTR 4 BL	50	7910190000
WTR 4/0.TNHE	50	2436380000

Type	Qty.	Order No.
WTR 4 STB	50	7910210000
WTR 4 STB BL	50	7910220000
WTR 4 STB/0.TNHE	50	2436390000

Type	current	Qty.	Order No.
ZQV 2.5N/2	24 A	60	1527540000
ZQV 2.5N/10	24 A	20	1527690000
ZQV 2.5N/2 GE	24 A	60	1693880000
ZQV 2.5N/10 GE	24 A	20	1693880000
WAP WTR2.5/ZZ		20	1074600000
WEW 35/2		100	1061200000
SIHA 1/G20	25		9537550000
SIHA 1/G20 10-36V	25		9537560000
SDS 0.6X3.5X100		1	9008330000
DEK 5/5 MC NE WS		1000	1609801044
WS 12/5 MC NE WS		720	1609860000
WS 8/6 MM WS		800	2007150000
DEK 5/6 MM WS		800	2007110000

Cross-connections, see section "W series accessories".

Type	current	Qty.	Order No.
ZQV 4N/10 GE	32 A	20	1758260000
ZQV 4N/2 GE	32 A	60	1758250000
WAP 2.5-10		50	1050000000
WAP 16+35 WTW 2.5-10		20	1050100000
WEW 35/2		100	1061200000
SIHA 3/G20	25		7921560000
SIHA 3/G20/LD 10-36V	25		7921570000
SIHA 3/G20/LD 140-250V	25		7921600000
BEST		50	1833100000
BEST/DRBR		50	1878570000
BEST/D		50	1878560000
TNST		50	1833090000
SDS 0.6X3.5X100		1	9008330000
WS 12/5 MC NE WS		720	1609860000
WS 8/6 MM WS		600	2007160000
DEK 5/6 MM WS		600	2007120000

Cross-connections, see section "W series accessories".

Type	current	Qty.	Order No.
ZQV 4N/10 GE	32 A	20	1758260000
ZQV 4N/2 GE	32 A	60	1758250000
WAP 2.5-10		50	1050000000
WAP 16+35 WTW 2.5-10		20	1050100000
WEW 35/2		100	1061200000
SIHA 3/G20	25		7921560000
SIHA 3/G20/LD 10-36V	25		7921570000
SIHA 3/G20/LD 140-250V	25		7921600000
BEST		50	1833100000
BEST/DRBR		50	1878570000
BEST/D		50	1878560000
TNST		50	1833090000
SDS 0.6X3.5X100		1	9008330000
PS 2.3 RT		20	0180400000
WS 12/5 MC NE WS		720	1609860000
WS 8/6 MM WS		600	2007160000
DEK 5/6 MM WS		600	2007120000

Cross-connections, see section "W series accessories".



WTR 4/ZR

4 mm²

Supplementary connection, right, with clamping screw

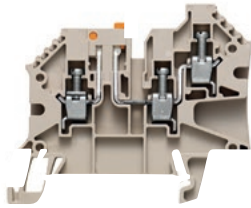

6.1 x 63.5 x 53
27 / 6
0.05...6



IEC	UL	CSA	EN 60079-7
500	600	600	
27	25	25	
4	AWG 30...10	AWG 30...10	
6 kV / 3			
A4 / V-0			

CE

Rated connection

0.5...6 / 1.5...6
0.5...4 / 0.5...4
0.5...1 Nm / (M 3)
10 / 0.6 x 3.5 mm

Type	Qty.	Order No.
WTR 4/ZR	50	1905080000
WTR 4/ZR/O.TNHE	50	2436400000

Type	current	Qty.	Order No.
ZQV 4N/2	32 A	60	1527930000
ZQV 4N/10	32 A	20	1528090000
WAP WDU/WTR4/ZR		50	1905070000
WEW 35/2		100	1061200000
SIHA 3/G20		25	7921560000
SIHA 3/G20/LD 10-36V		25	7921570000
SIHA 3/G20/LD 140-250V		25	7921600000
BEST		50	1833100000
BEST/DRBR		50	1878570000
BEST/D		50	1878560000
TNST		50	1833090000
SDS 0.6X3.5X100		1	9008330000
DEK 5/5 MC NE WS		1000	1609801044
WS 12/5 MC NE WS		720	1609860000
DEK 5/6 MM WS		600	2007120000
WS 8/6 MM WS		600	2007160000

Cross-connections, see section "W series accessories".

WTR 4/ZR STB

4 mm²

Supplementary connection, with socket

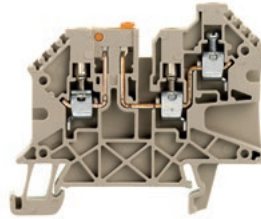

6.1 x 63.5 x 53
27 / 6
0.05...6

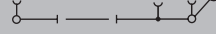

IEC	UL	CSA	EN 60079-7
500	600	600	
27	25	25	
4	AWG 30...10	AWG 30...10	
6 kV / 3			
A4 / V-0			

CE

Rated connection

0.5...6 / 1.5...6
0.5...4 / 0.5...4
0.5...1 Nm / (M 3)
10 / 0.6 x 3.5 mm

Type	Qty.	Order No.
WTR 4/ZR STB	50	1905110000
WTR 4/ZR STB/O.TNHE	50	2436410000

Type	current	Qty.	Order No.
ZQV 4N/2	32 A	60	1527930000
ZQV 4N/10	32 A	20	1528090000
WAP WDU/WTR4/ZR		50	1905070000
WEW 35/2		100	1061200000
SIHA 3/G20		25	7921560000
SIHA 3/G20/LD 10-36V		25	7921570000
SIHA 3/G20/LD 140-250V		25	7921600000
BEST		50	1833100000
BEST/DRBR		50	1878570000
BEST/D		50	1878560000
TNST		50	1833090000
SDS 0.6X3.5X100		1	9008330000
PS 2.3 RT		20	0180400000
DEK 5/5 MC NE WS		1000	1609801044
WS 12/5 MC NE WS		720	1609860000
DEK 5/6 MM WS		600	2007120000
WS 8/6 MM WS		600	2007160000

Cross-connections, see section "W series accessories".

WTR 4 SL

4 mm²

With clamping screw

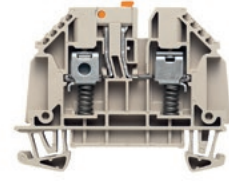

6.1 x 61.5 x 46.5
32 / 6
0.22...6



IEC 60947-7-1

IEC	UL	CSA	EN 60079-7
500	300	300	
32	22	10	
4	AWG 22...10	AWG 22...10	
6 kV / 3			
A4 / V-0			

CE

Rated connection

0.5...6 / 1.5...6
0.5...4 / 0.5...4
0.5...0.6 Nm / (M 3)
13 / 0.6 x 3.5 mm

UL/CSA 600 V possible with end plate WAP or WTW partition plate.

Type	Qty.	Order No.
WTR 4 SL	50	7910270000
WTR 4 SL BL	50	7910280000

With pollution severity degree 2, the voltage can be raised to 630 V.

Type	current	Qty.	Order No.
ZQV 4N/2	32 A	60	1527930000
ZQV 4N/10	32 A	20	1528090000
WAP 2.5-10		50	1050000000
WAP 16+35 WTW 2.5-10		20	1050100000
WEW 35/2		100	1061200000
DEK 5/6 MC NE WS		1000	1609820000
WS 12/6 MC NE WS		600	1609900000
DEK 5/6 MM WS		600	2007120000
WS 8/6 MM WS		600	2007160000
HBT 1,5 - 3,0 RT		100	1312440000
HBT 2,5 - 3,0 BL		100	1312450000

Cross-connections, see section "W series accessories".



Screw connection with clamping yoke technology (W-Series)

Test-disconnect terminal blocks

Universal range

A

WTR 4 SL STB

4 mm²

With socket

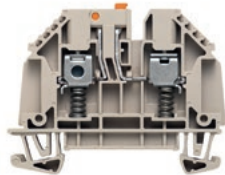

WTR 4 SL/EN

4 mm²

with clamping screw

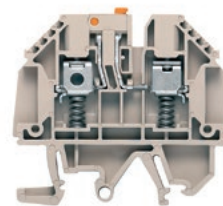

Width/Height/Depth	mm
max. current / max. cond. cross-section	A/mm ²
Max. clamping range	mm ²

6.1 x 61.5 x 46.5
32 / 6
0.22...6

6.1 x 61.5 x 51
32 / 6
0.22...6

Technical data

Rated data	
Rated voltage of feed-through terminal	V
Rated current	A
for wire cross-section	mm ²
Rated impulse withstand voltage / Pollution severity	
Gauge to IEC 60947-1 / UL 94 flammability rating	
Number of operating cycles	
Approvals	

Clamped conductors (H05V/H07V)	
Solid / Stranded	mm ²
Flexible / Flexible with ferrule	mm ²
Tightening torque (clamping screw for copper conductors)	
Stripping length / Blade size	mm/-

Note

IEC 60947-7-1

IEC	UL	CSA	EN 60079-7
500	300	300	
32	22	10	
4	AWG 22...10	AWG 22...10	
6 kV / 3			
A4 / V-0			



Rated connection	
0.5...6 / 1.5...6	
0.5...4 / 0.5...4	
0.5...0.6 Nm / (M 3)	
13 / 0.6 x 3.5 mm	

UL/CSA 600 V possible with end plate WAP or WTW partition plate.

IEC 60947-7-1

IEC	UL	CSA	EN 60079-7
500	300	300	
32	22	10	
4	AWG 22...10	AWG 22...10	
6 kV / 3			
A4 / V-0			



Rated connection	
0.5...6 / 1.5...6	
0.5...4 / 0.5...4	
0.5...1 Nm / (M 3)	
13 / 0.6 x 3.5 mm	

UL/CSA 600 V possible with end plate WAP or WTW partition plate.

Ordering data

Version	
	dark beige
	blue

Note

Type	Qty.	Order No.
WTR 4 STB SL	50	7910300000
WTR 4 STB SL BL	50	7910310000

Type	Qty.	Order No.
WTR4 SL/EN	50	7910360000
WTR4 SL/EN BL	50	7910370000

With pollution severity degree 2, the voltage can be raised to 630 V.

Accessories

Pluggable cross-connection	
	2-pole
	10-pole

End plate / Partition plate	
	dark beige
	dark beige

End bracket

Hak. Cable lugs

Testing / Checking

Identification systems

Type	current	Qty.	Order No.
ZQV 4N/2	32 A	60	1527930000
ZQV 4N/10	32 A	20	1528090000

WAP 2.5-10	50	1050000000
WAP 16+35 WTW 2.5-10	20	1050100000

WEW 35/2

HBT 1,5 - 3,0 RT

HBT 2,5 - 3,0 BL

PS 2.3 RT

DEK 5/6 MC NE WS

WS 12/6 MC NE WS

DEK 5/6 MM WS

WS 8/6 MM WS

Type	current	Qty.	Order No.
ZQV 4N/2	32 A	60	1527930000
ZQV 4N/10	32 A	20	1528090000

WAP 2.5-10	50	1050000000
WAP 16+35 WTW 2.5-10	20	1050100000

WEW 35/2

HBT 1,5 - 3,0 RT

HBT 2,5 - 3,0 BL

DEK 5/6 MC NE WS

WS 12/6 MC NE WS

DEK 5/6 MM WS

WS 8/6 MM WS

For detailed information on other accessories and application in the online catalogue

Cross-connections, see section "W series accessories".

Cross-connections, see section "W series accessories".

WTR 4 STB SL/EN

4 mm²

With socket

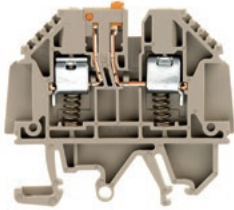

6.1 x 61.5 x 51
32 / 6
0.22...6



IEC 60947-7-1

IEC	UL	CSA	EN 60079-7
500	300	300	
32	22	10	
4	AWG 22...10	AWG 22...10	
6 kV / 3			
A4 / V-0			



Rated connection

0.5...6 / 1.5...6

0.5...4 / 0.5...4

0.5...1 Nm / (M 3)

13 / 0.6 x 3.5 mm

UL/CSA 600 V possible with end plate WAP or WTW partition plate.

Type	Qty.	Order No.
WTR4 SL/EN STB	50	7910390000

Type	current	Qty.	Order No.
ZQV 4N/2	32 A	60	1527930000
ZQV 4N/10	32 A	20	1528090000
WAP 2.5-10		50	1050000000
WAP 16+35 WTW 2.5-10		20	1050100000
WEW 35/2		100	1061200000
HBT 1,5 - 3,0 RT		100	1312440000
HBT 2,5 - 3,0 BL		100	1312450000
DEK 5/6 MC NE WS		1000	1609820000
WS 12/6 MC NE WS		600	1609900000
DEK 5/6 MM WS		600	2007120000
WS 8/6 MM WS		600	2007160000

Cross-connections, see section "W series accessories".



Screw connection with clamping yoke technology (W-Series)

Test-disconnect terminal blocks

Universal range

A

WDT 1.5/1

1.5 mm²

Disconnection lower level



WDT 1.5/2

1.5 mm²

Disconnection both levels

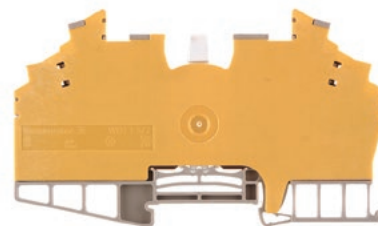

Width/Height/Depth	mm
max. current / max. cond. cross-section	A/mm ²
Max. clamping range	mm ²

6.4 x 112 x 66	
10 / 2.5	
0.13...2.5	

6.4 x 112 x 66	
10 / 2.5	
0.13...2.5	

Technical data

Rated data	
Rated voltage of feed-through terminal	V
Rated current	A
for wire cross-section	mm ²
Rated impulse withstand voltage / Pollution severity	
Gauge to IEC 60947-1 / UL 94 flammability rating	
Number of operating cycles	
Approvals	

Clamped conductors (H05V/H07V)	
Solid / Stranded	mm ²
Flexible / Flexible with ferrule	mm ²
Tightening torque (clamping screw for copper conductors)	
Stripping length / Blade size	mm/-

Note

IEC 60947-7-1

IEC	UL	CSA	EN 60079-7
250	300	300	
10	10	10	
1.5	AWG 26...14	AWG 26...14	
4 kV / 3			
A2 / V-0			

CE ENEC NEMA

Rated connection	
0.5...2.5 / 1.5...2.5	
0.5...1.5 / 0.5...1.5	
0.4...0.6 Nm / (M 2.5)	
10 / 0.6 x 3.5 mm	

IEC 60947-7-1

IEC	UL	CSA	EN 60079-7
250	300	300	
10	10	10	
1.5	AWG 26...14	AWG 26...14	
4 kV / 3			
A2 / V-0			

CE ENEC NEMA

Rated connection	
0.5...2.5 / 1.5...2.5	
0.5...1.5 / 0.5...1.5	
0.4...0.6 Nm / (M 2.5)	
10 / 0.6 x 3.5 mm	

Ordering data

Version	
	dark beige
	without STB
	blue

Note

Type	Qty.	Order No.
WDT 1.5/1 DB/GE	25	1015800000

Type	Qty.	Order No.
WDT 1.5/2 DB/GE	25	1015900000

Accessories

End bracket	dark beige
Holder for cartridge fuse 5 x 20 mm	400 V AC/DC, without LED 10 - 36 V AC/DC, red LED
Screwdriver	Standard
Locking lever	
Identification systems	

Type	current	Qty.	Order No.
WEW 35/2		100	1061200000
SDS 0.6X3.5X100		1	9008330000
RAHE LN WDT1.5		10	1865410000
DEK 5/6.5 MC NE WS		900	1609840000
WS 8/5 MC NE WS		720	1640740000

Type	current	Qty.	Order No.
WEW 35/2		100	1061200000
SDS 0.6X3.5X100		1	9008330000
RAHE LN WDT1.5		10	1865410000
DEK 5/6.5 MC NE WS		900	1609840000
WS 8/5 MC NE WS		720	1640740000

For detailed information on other accessories and application in the online catalogue

WDT 1.5/3

1.5 mm²

Disconnection lower level or both levels

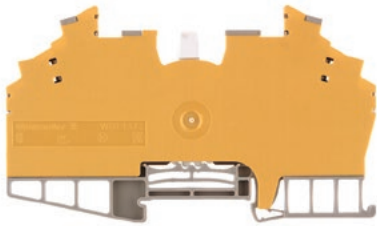

6.4 x 112 x 66
10 / 2.5
0.13...2.5



IEC 60947-7-1

IEC	UL	CSA	EN 60079-7
250	300	300	
10	10	10	
1.5	AWG 26...14	AWG 26...14	
4 kV / 3			
A2 / V-2			

CE

Rated connection

0.5...2.5 / 1.5...2.5

0.5...1.5 / 0.5...1.5

0.4...0.6 Nm / (M 2.5)

10 / 0.6 x 3.5 mm

WDT 1.5/3 BL/HB Order no. 1016160000 flammability rating V2

Type	Qty.	Order No.
WDT 1.5/3 DB/GE	25	1016000000
WDT 1.5/3 BL/HB	25	1016160000

Type	current	Qty.	Order No.
WEW 35/2		100	1061200000
SDS 0.6X3.5X100		1	9008330000
RAHE LN WDT1.5		10	1865410000
DEK 5/6.5 MC NE WS		900	1609840000
WS 8/5 MC NE WS		720	1640740000

WDTR 2.5

2.5 mm²

Double disconnect terminal

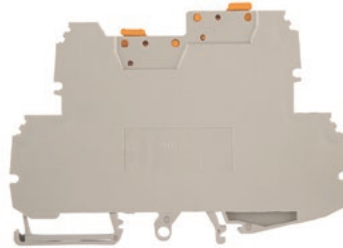

6.2 x 94 x 67
14 / 4
0.05...4

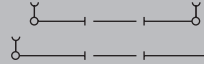

IEC 60947-7-1

IEC	UL	CSA	EN 60079-7
400	300	300	
10	10	10	
2.5	AWG 26...12	AWG 30...12	
4 kV / 3			
A3 / V-0			

CE

Rated connection

0.5...4 / 1.5...4

0.5...2.5 / 0.5...2.5

0.5...0.6 Nm / (M 3)

8 / 0.6 x 3.5 mm

Type	Qty.	Order No.
WDTR 2.5	25	9528070000
WDTR 2.5 0.STB	25	1298020000
WDTR 2.5 BL	25	9528080000

Type	current	Qty.	Order No.
WEW 35/1		50	1059000000
SIHA 1/G20		25	9537550000
SIHA 1/G20 10-36V		25	9537560000
SDS 0.6X3.5X100		1	9008330000
DEK 5/6 MC NE WS		1000	1609820000
WS 8/5 MC NE WS		720	1640740000
DEK 5/5 MM WS		800	2007110000
WS 8/5 MM WS		800	2007150000

External cross-connection is possible with the VQB 1.5/50. Refer to "Accessories" Chapter.

WDTR 2.5/WE

2.5 mm²

Double disconnect terminal

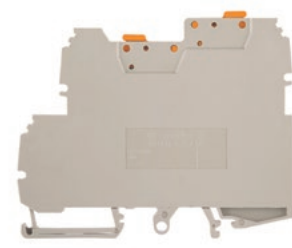

6.2 x 81 x 67
23 / 4
0.05...4

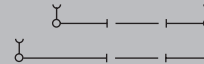

IEC 60947-7-1

IEC	UL	CSA	EN 60079-7
400	300	300	
10	10	17	
2.5	AWG 22...12	AWG 26...12	
4 kV / 3			
A3 / V-0			

CE

Rated connection

0.5...4 / 1.5...4

0.5...2.5 / 0.5...2.5

0.5...0.6 Nm / (M 3)

8 / 0.6 x 3.5 mm

Type	Qty.	Order No.
WDTR 2.5/WE	25	9528090000

Type	current	Qty.	Order No.
WEW 35/1		50	1059000000
SIHA 1/G20		25	9537550000
SIHA 1/G20 10-36V		25	9537560000
SDS 0.6X3.5X100		1	9008330000
DEK 5/6 MC NE WS		1000	1609820000
WS 8/5 MC NE WS		720	1640740000
DEK 5/5 MM WS		800	2007110000
WS 8/5 MM WS		800	2007150000

External cross-connection is possible with the VQB 1.5/50. Refer to "Accessories" Chapter.



Screw connection with clamping yoke technology (W-Series)

Test-disconnect terminal blocks

Universal range

A

WDK 2.5/TR-DU

2.5 mm²

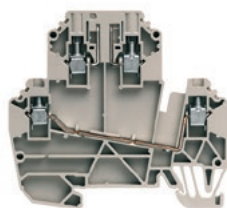

WDK 2.5/TR-DU/STB

2.5 mm²

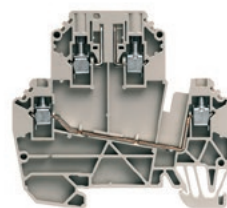

Width/Height/Depth	mm
max. current / max. cond. cross-section	-/mm ²
Max. clamping range	mm ²

5.1 x 80.5 x 66	
/ 4	
0.5...4	

5.1 x 80.5 x 66	
/ 4	
0.5...4	

Technical data

Rated data	
Rated voltage of feed-through terminal	V
Rated current	A
for wire cross-section	mm ²
Rated impulse withstand voltage / Pollution severity	
Gauge to IEC 60947-1 / UL 94 flammability rating	
Number of operating cycles	
Approvals	
Clamped conductors (H05V/H07V)	
Solid / Stranded	mm ²
Flexible / Flexible with ferrule	mm ²
Tightening torque (clamping screw for copper conductors)	
Stripping length / Blade size	mm/-

IEC	UL	CSA	EN 60079-7
690		300	
24		20	
2.5		AWG 30...12	
		8 kV / 3	
		A2 / V-0	
Rated connection			
0.5...4 / 1.5...4			
0.5...4 / 0.5...2.5			
0.5...0.6 Nm / (M 3)			
8 / 0.6 x 3.5 mm			

IEC	UL	CSA	EN 60079-7
690		300	
24		20	
2.5		AWG 30...12	
		8 kV / 3	
		A2 / V-0	
Rated connection			
0.5...4 / 1.5...4			
0.5...4 / 0.5...2.5			
0.5...0.6 Nm / (M 3)			
8 / 0.6 x 3.5 mm			

Note

Ordering data

Version	
	dark beige
	without isolator, dark beige
Note	

Type	Qty.	Order No.
WDK 2.5/TR-DU	50	1247290000
WDK 2.5/TR-DU/o TNHE	50	1833600000

Type	Qty.	Order No.
WDK 2.5/TR-DU STB	50	1247310000
WDK 2.5/TR-DU/o TNHE StB	50	1833610000

Accessories

Screwable cross-connection	
	2-pole
	10-pole
End plate / Partition plate	
	dark beige
End bracket	
	dark beige
Holder for cartridge fuse 5 x 20 mm	
	400 V AC/DC, without LED
	10 - 36 V AC/DC, red LED
	140 - 250 V AC/DC, red LED
Module connector (max. 250 V)	
	without fittings
	With 1N4007 diode
	with wire jumper
Disconnect plug	
	removable, as replacement for release lever
Screwdriver	
	Standard
Testing / Checking	
	Test plug
Identification systems	

Type	current	Qty.	Order No.
WQV 2.5/2	32 A	50	1053660000
WQV 2.5/10	32 A	20	1054460000
WAP WDK 2.5N/TR-DU		50	1839850000
WEW 35/1		50	1059000000
SIHA 3/G20		25	7921560000
SIHA 3/G20/LD 10-36V		25	7921570000
SIHA 3/G20/LD 140-250V		25	7921600000
BEST		50	1833100000
BEST/D		50	1878560000
BEST/DRBR		50	1878570000
TNST		50	1833090000
SDS 0.6X3.5X100		1	9008330000
DEK 5/5 MC NE WS		1000	1609801044
WS 8/5 MC NE WS		720	1640740000
DEK 5/5 MM WS		800	2007110000
WS 8/5 MM WS		800	2007150000

Type	current	Qty.	Order No.
WQV 2.5/2	32 A	50	1053660000
WQV 2.5/10	32 A	20	1054460000
WAP WDK 2.5N/TR-DU		50	1839850000
WEW 35/1		50	1059000000
SIHA 3/G20		25	7921560000
SIHA 3/G20/LD 10-36V		25	7921570000
SIHA 3/G20/LD 140-250V		25	7921600000
BEST		50	1833100000
BEST/D		50	1878560000
BEST/DRBR		50	1878570000
TNST		50	1833090000
SDS 0.6X3.5X100		1	9008330000
PS 2.3 RT		20	0180400000
DEK 5/5 MC NE WS		1000	1609801044
WS 8/5 MC NE WS		720	1640740000
DEK 5/5 MM WS		800	2007110000
WS 8/5 MM WS		800	2007150000

For detailed information on other accessories and application in the online catalogue

Cross-connections, see section "W series accessories".

Cross-connections, see section "W series accessories".

WDK 2.5/TR-DU-PE

2.5 mm²

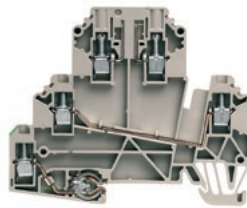

WDK 2.5/TR-DU-PE/STB

2.5 mm²

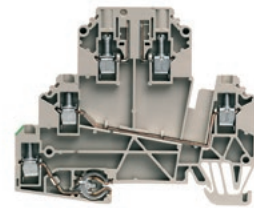

Width/Height/Depth	mm
max. current / max. cond. cross-section	-/mm ²
Max. clamping range	mm ²

Technical data

Rated data	
Rated voltage of feed-through terminal	V
Rated current	A
for wire cross-section	mm ²
Rated impulse withstand voltage / Pollution severity	
Gauge to IEC 60947-1 / UL 94 flammability rating	
Number of operating cycles	
Approvals	
Clamped conductors (H05V/H07V)	
Solid / Stranded	mm ²
Flexible / Flexible with ferrule	mm ²
Tightening torque (clamping screw for copper conductors)	
Stripping length / Blade size	mm/-
Note	

IEC	UL	CSA	EN 60079-7
690			
24			
2.5			
	8 kV / 3		
	A2 / V-0		
Rated connection			
0.5...4 / 1.5...4			
0.5...4 / 0.5...2.5			
0.5...0.6 Nm / (M 3)			
8 / 0.6 x 3.5 mm			
Note			

IEC	UL	CSA	EN 60079-7
690			
24			
2.5			
	8 kV / 3		
	A2 / V-0		
Rated connection			
0.5...4 / 1.5...4			
0.5...4 / 0.5...2.5			
0.5...0.6 Nm / (M 3)			
8 / 0.6 x 3.5 mm			
Note			

Ordering data

Version	
	dark beige
	without isolator, dark beige
Note	

Type	Qty.	Order No.
WDK 2.5/TR-DU-PE	50	1247420000
WDK 2.5/TR-DU-PE/o TNHE	50	1833640000
Note		

Type	Qty.	Order No.
WDK 2.5/TR-DU-PE STB	50	1247430000
Note		

Accessories

Screwable cross-connection	
	2-pole
	10-pole
End plate / Partition plate	
	dark beige
End bracket	
	dark beige
Holder for cartridge fuse 5 x 20 mm	
	400 V AC/DC, without LED
	10 - 36 V AC/DC, red LED
	140 - 250 V AC/DC, red LED
Module connector (max. 250 V)	
	without fittings
	With 1N4007 diode
	with wire jumper
Disconnect plug	
	removable, as replacement for release lever
Screwdriver	
	Standard
Testing / Checking	
	Test plug
Identification systems	

Type	current	Qty.	Order No.
WQV 2.5/2	32 A	50	1053660000
WQV 2.5/10	32 A	20	1054460000
WAP WDK 2.5N/TR-DU			
		50	1839850000
WEW 35/1			
		50	1059000000
SIHA 3/G20		25	7921560000
SIHA 3/G20/LD 10-36V		25	7921570000
SIHA 3/G20/LD 140-250V		25	7921600000
BEST		50	1833100000
BEST/D		50	1878560000
BEST/DRBR		50	1878570000
TNST		50	1833090000
SDS 0.6X3.5X100		1	9008330000
Note			
DEK 5/5 MC NE WS		1000	1609801044
WS 8/5 MC NE WS		720	1640740000
DEK 5/5 MM WS		800	2007110000
WS 8/5 MM WS		800	2007150000

Type	current	Qty.	Order No.
WQV 2.5/2	32 A	50	1053660000
WQV 2.5/10	32 A	20	1054460000
WAP WDK 2.5N/TR-DU			
		50	1839850000
WEW 35/1			
		50	1059000000
SIHA 3/G20		25	7921560000
SIHA 3/G20/LD 10-36V		25	7921570000
SIHA 3/G20/LD 140-250V		25	7921600000
BEST		50	1833100000
BEST/D		50	1878560000
BEST/DRBR		50	1878570000
TNST		50	1833090000
SDS 0.6X3.5X100		1	9008330000
PS 2.3 RT		20	0180400000
DEK 5/5 MC NE WS		1000	1609801044
WS 8/5 MC NE WS		720	1640740000
DEK 5/5 MM WS		800	2007110000
WS 8/5 MM WS		800	2007150000

For detailed information on other accessories and application in the online catalogue

Cross-connections, see section "W series accessories".

Cross-connections, see section "W series accessories".



Screw connection with clamping yoke technology (W-Series)

Pluggable terminal blocks

Universal range

A

WT 2.5

2.5 mm²

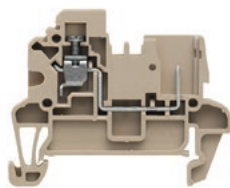

WDT 2.5 BT

2.5 mm²

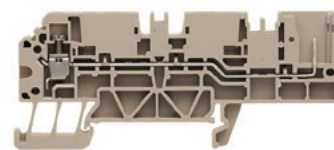

Width/Height/Depth	mm
max. current / max. cond. cross-section	A/mm ²
Max. clamping range	mm ²

5.1 x 50.5 x 40	
27 / 4	
0.13...4	

5.1 x 85.5 x 36	
27 / 4	
0.13...4	

Technical data

Rated data	
Rated voltage of feed-through terminal	V
Rated current	A
for wire cross-section	mm ²
Rated impulse withstand voltage / Pollution severity	6 kV / 3
Gauge to IEC 60947-1 / UL 94 flammability rating	A4 / V-0
Approvals	
Clamped conductors (H05V/H07V)	
Solid / Stranded	mm ²
Flexible / Flexible with ferrule	mm ²
Tightening torque (clamping screw for copper conductors)	0.4...0.6 Nm / (M 2.5)
Stripping length / Blade size	7 / 0.6 x 3.5 mm

IEC 60947-7-1, IEC 61984

IEC	UL	CSA	EN 60079-7
500	300	300	
24	20	20	
2.5	AWG 26...12	AWG 16...12	
6 kV / 3			
A4 / V-0			

Rated connection	
Solid / Stranded	0.5...4 / 1.5...4
Flexible / Flexible with ferrule	0.5...4 / 0.5...2.5
Tightening torque (clamping screw for copper conductors)	0.4...0.6 Nm / (M 2.5)
Stripping length / Blade size	7 / 0.6 x 3.5 mm

IEC 60947-7-1, IEC 61984

IEC	UL	CSA	EN 60079-7
500	300	300	
24	20	20	
2.5	AWG 26...12	AWG 26...12	
6 kV / 3			
A4 / V-0			

Rated connection	
Solid / Stranded	0.5...4 / 1.5...4
Flexible / Flexible with ferrule	0.5...4 / 0.5...2.5
Tightening torque (clamping screw for copper conductors)	0.4...0.6 Nm / (M 2.5)
Stripping length / Blade size	7 / 0.6 x 3.5 mm

Note

Ordering data

Type	Qty.	Order No.
WT 2.5	50	1305330000

Type	Qty.	Order No.
WP 2.5/1AN/1	50	1305270000
WP 2.5/1AN/10	50	1305280000

Note

Type	Qty.	Order No.
WDT 2.5 BT	50	1305310000

Type	Qty.	Order No.
WP 2.5/1AN/1	50	1305270000
WP 2.5/1AN/10	50	1305280000

Type	Qty.	Order No.
WDT 2.5 BT	50	1305310000

Type	Qty.	Order No.
WP 2.5/1AN/1	50	1305270000
WP 2.5/1AN/10	50	1305280000

Accessories

Type	current	Qty.	Order No.
ZQV 2.5N/2	24 A	60	1527540000
ZQV 2.5N/10	24 A	20	1527690000
WAP WDT 2.5 AT		50	1305250000
WEW 35/2		100	1061200000
APGSR 2.5		25	2457580000
APGCE		50	1514490000
APGLE 2.5		25	2457570000
SDS 0.6X3.5X100		1	9008330000
DEK 5/5 MC NE WS		1000	1609801044
WS 10/5 MC NE WS		720	1635000000
DEK 5/5 MM WS		800	2007110000
WS 8/5 MM WS		800	2007150000

Vertical jumpers

1-pole

Type	current	Qty.	Order No.
ZQV 2.5N/2	24 A	60	1527540000
ZQV 2.5N/10	24 A	20	1527690000
WAP WDT 2.5 BT		50	1305240000
AH WDT 2.5 BT		50	1305230000
WEW 35/2		100	1061200000
APGSR 2.5		25	2457580000
APGCE		50	1514490000
APGLE 2.5		25	2457570000
SDS 0.6X3.5X100		1	9008330000
WDT 2.5 AT		50	1305320000
DEK 5/5 MC NE WS		1000	1609801044
WS 10/5 MC NE WS		720	1635000000
DEK 5/5 MM WS		800	2007110000
WS 8/5 MM WS		800	2007150000

Type	current	Qty.	Order No.
ZQV 2.5N/2	24 A	60	1527540000
ZQV 2.5N/10	24 A	20	1527690000
WAP WDT 2.5 BT		50	1305240000
AH WDT 2.5 BT		50	1305230000
WEW 35/2		100	1061200000
APGSR 2.5		25	2457580000
APGCE		50	1514490000
APGLE 2.5		25	2457570000
SDS 0.6X3.5X100		1	9008330000
WDT 2.5 AT		50	1305320000
DEK 5/5 MC NE WS		1000	1609801044
WS 10/5 MC NE WS		720	1635000000
DEK 5/5 MM WS		800	2007110000
WS 8/5 MM WS		800	2007150000

For detailed information on other accessories and application in the online catalogue

Cross-connections, see section "W series accessories".

Cross-connections, see section "W series accessories".

WDT 2.5 AT

2.5 mm²

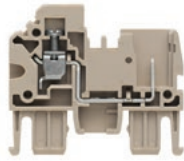

5.1 x 42 x 24.6
27 / 4
0.13...4



IEC 60947-7-1, IEC 61984

IEC	UL	CSA	EN 60079-7
500	300	300	
24	20	20	
2.5	AWG 26...12	AWG 26...12	
6 kV / 3			
A4 / V-0			



Rated connection

0.5...4 / 1.5...4
0.5...4 / 0.5...2.5
0.4...0.6 Nm / (M 2.5)
7 / 0.6 x 3.5 mm

WDT 2.5/2

2.5 mm²

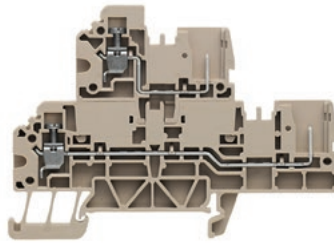

5.1 x 85.5 x 60.5
27 / 4
0.13...4

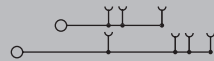

IEC 60947-7-1, IEC 61984

IEC	UL	CSA	EN 60079-7
500	300	300	
24	20	20	
2.5	AWG 26...12	AWG 26...12	
6 kV / 3			
A4 / V-0			



Rated connection

0.5...4 / 1.5...4
0.5...4 / 0.5...2.5
0.4...0.6 Nm / (M 2.5)
7 / 0.6 x 3.5 mm

WDT 2.5/2 V

2.5 mm²

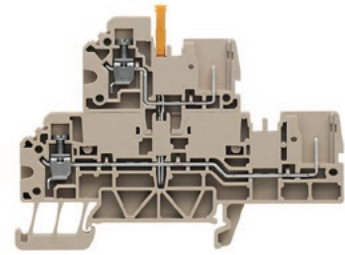

5.1 x 85.5 x 60.5
27 / 4
0.13...4

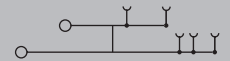

IEC 60947-7-1, IEC 61984

IEC	UL	CSA	EN 60079-7
400	300	300	
24	20.1	10	
2.5	AWG 26...12	AWG 26...12	
6 kV / 3			
A4 / V-0			



Rated connection

0.5...4 / 1.5...4
0.5...4 / 0.5...2.5
0.4...0.6 Nm / (M 2.5)
7 / 0.6 x 3.5 mm

Type	Qty.	Order No.
WDT 2.5 AT	50	1305320000
WP 2.5/1AN/1	50	1305270000
WP 2.5/1AN/10	50	1305280000

Type	Qty.	Order No.
WDT 2.5/2	50	1305290000
WP 2.5/1AN/1	50	1305270000
WP 2.5/1AN/10	50	1305280000

Type	Qty.	Order No.
WDT 2.5/2 V	50	1305300000
WP 2.5/1AN/1	50	1305270000
WP 2.5/1AN/10	50	1305280000

Type	current	Qty.	Order No.
ZQV 2.5N/2	24 A	60	1527540000
ZQV 2.5N/10	24 A	20	1527690000
WAP WDT 2.5 AT		50	1305250000
APGSR 2.5		25	2457580000
APGCE		50	1514490000
APGLE 2.5		25	2457570000
SDS 0.6X3.5X100		1	9008330000
DEK 5/5 MC NE WS		1000	1609801044
WS 10/5 MC NE WS		720	1635000000
DEK 5/5 MM WS		800	2007110000
WS 8/5 MM WS		800	2007150000

Type	current	Qty.	Order No.
ZQV 2.5N/2	24 A	60	1527540000
ZQV 2.5N/10	24 A	20	1527690000
WAP WDT 2.5/2		50	1305260000
WEW 35/2		100	1061200000
APGSR 2.5		25	2457580000
APGCE		50	1514490000
APGLE 2.5		25	2457570000
SDS 0.6X3.5X100		1	9008330000
DEK 5/5 MC NE WS		1000	1609801044
WS 10/5 MC NE WS		720	1635000000
DEK 5/5 MM WS		800	2007110000
WS 8/5 MM WS		800	2007150000
ZVQ 2.5/1.5	23 A	50	1720700000

Type	current	Qty.	Order No.
ZQV 2.5N/2	24 A	60	1527540000
ZQV 2.5N/10	24 A	20	1527690000
WAP WDT 2.5/2		50	1305260000
WEW 35/2		100	1061200000
APGSR 2.5		25	2457580000
APGCE		50	1514490000
APGLE 2.5		25	2457570000
SDS 0.6X3.5X100		1	9008330000
DEK 5/5 MC NE WS		1000	1609801044
WS 10/5 MC NE WS		720	1635000000
DEK 5/5 MM WS		800	2007110000
WS 8/5 MM WS		800	2007150000

Cross-connections, see section "W series accessories".

ZVQ 2.5/1.5 (1720700000) connects the upper and lower layers. Cross-connections, see section "W series accessories".

Cross-connections, see section "W series accessories".



Screw connection with clamping-yoke technology (W-Series)
Pluggable terminal blocks – Accessories

Single plates for individual assembly

WeiCoS individual plates increase flexibility by providing a solution for every task. The plug-in connector is assembled directly on-site in line with application requirements. Each individual plate is available in green (GN) and beige (BE).

WeiCoS plug

- Single plates, plug ZP 2.5/1AN
- Marking option

Ordering data	
	2.5 mm ²
	4.0 mm ²
Note	

WP 2.5/1AN/1

Start plate



Type	Qty.	Order No.
WP 2.5/1AN/1 ZA	50	1350990000
WP4/1AN/1 ZA	50	1108490000

WP 2.5/1AN ZA 0.RA

Middle plate or end plate



Type	Qty.	Order No.
WP 2.5/1AN/1 ZA 0.RA	50	1351000000

WP 2.5/1AN ZA

Middle plate or end plate



Type	Qty.	Order No.
WP 2.5/1AN/1	50	1305270000
WP4/1AN/1	50	1107790000

Coding elements

- For specific coding of the plug-in stations
- Protection against accidental mistake ensures process reliability

Ordering data	
	4.0 mm ²
	1.5 mm ² / 2.5 mm ²
Note	

KOSF ZT

Coding elements



Type	Qty.	Order No.
KOSF ZT4	50	1856860000
APGCE	50	1514490000

Application



Interlock

- ZVR ZP to interlock with the terminal block
- ZVR ZPS interlock, plug – socket

Ordering data	
	2.5 mm ²
Note	

ZVR ZP 2.5

Locking element



Type	Qty.	Order No.
APGLE 2.5	25	2457570000

Application ZVR ZP

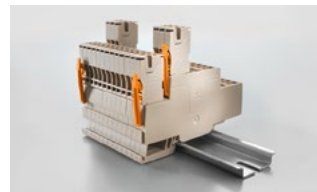

Strain reliefs / Protective cover

- ZVR ZP Strain relief transmits mechanical forces to the plastic housing and protects the contact point
- ZAD ZT / ZPS Finger protection Protects the contact point from dirt

Ordering data	
	2.5 mm ²
	4.0 mm ²
Note	

ZZE ZP

Strain reliefs



Type	Qty.	Order No.
APGSR 2.5	25	2457580000
APGSR 2.5/4	25	2457590000
APGSR 2.5/8	25	2457600000
ZVR ZP4	25	1855250000

ZAD ZT / ZPS

Protective cover



Type	Qty.	Order No.
ZAD ZT/ZPS 2.5	25	1861030000

Application ZZE ZP



Screw connection with clamping-yoke technology (W-Series)

Pluggable terminal blocks

WT4 4 AN/2

4 mm²

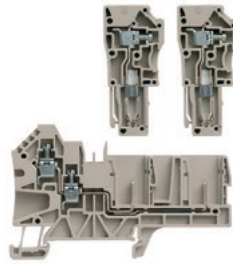

Width/Height/Depth	mm
max. current / max. cond. cross-section	-/mm ²
Max. clamping range	mm ²

6.1 x 84.3 x 50
/ 6
0.5...6

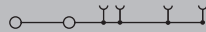

Technical data

Rated data	
Rated voltage	V
Max. voltage of clamp support & pluggable system	-
Rated current	A
for wire cross-section	mm ²
Rated impulse withstand voltage / Pollution severity	
Gauge to IEC 60947-1 / UL 94 flammability rating	
Approvals	
Clamped conductors (H05V/H07V)	
Solid / Stranded	mm ²
Flexible / Flexible with ferrule	mm ²
Tightening torque (clamping screw for copper conductors)	
Stripping length / Blade size	-/-

In accordance with IEC 60947-7-1

IEC	UL	CSA	EN 60079-7
800	600		
32	30		
4	AWG 26...10		
	8 kV / 3		
	A4 / V-0		

UL

Rated connection	Plug-in connection
0.5...6 / 0.5...6	
0.5...4 / 0.5...4	
/ 0.6 x 3.5 mm	

Note

Ordering data

Version	dark beige
Note	

Type	Qty.	Order No.
WT4 4AN/2	50	1107680000

Accessories

Pluggable cross-connection	
	2-pole
	10-pole
End plate / Partition plate	dark beige
End bracket	dark beige
Miscellaneous accessories WeiCoS	
	Locking element
	Coding element
	Strain relief
Plug-in connector	
Screwdriver	Standard
Identification systems	

Type	current	Qty.	Order No.
ZQV 4N/2	32 A	60	1527930000
ZQV 4N/10	32 A	20	1528090000
WAP WT4/4AN/2		50	1107780000
WEW 35/2		100	1061200000
ZVR ZP4		25	1855250000
KOSF ZT4		50	1856860000
ZZE ZP4		25	1855260000
WP4/1AN/1		50	1107790000
WP4/1AN/1 ZA		50	1108490000
WP4/1AN/10		10	1107800000
SDS 0.6X3.5X100		1	9008330000
DEK 5/6 MC NE WS		1000	1609820000
DEK 5/6 MM WS		600	2007120000
WS 8/6 MM WS		600	2007160000

For detailed information on other accessories and application in the online catalogue

Cross-connections, see section "W series accessories".

WDU 2.5 F

2.5 mm²

Spade connection right

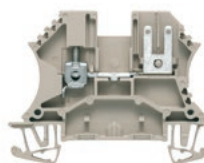

Width/Height/Depth	mm
max. current / max. cond. cross-section	A/mm ²
Max. clamping range	mm ²

5.1 x 60 x 46.25	F2.8 F2.8
12 / 4	
0.13...4	

IEC 61210, In accordance with IEC 60947-7-1

IEC	UL	CSA	EN 60079-7
500	300	300	
12	16	10	
2.5	AWG 22...12	AWG 26...12	
6 kV / 3			
A3 / V-0			

CE, ENEC, KEMA, UL, VDE

Rated connection	Plug-in connection
0.5...4 / 1.5...4	
0.5...4 / 0.5...2.5	
0.4...0.8 Nm / (M 2.5)	
10 / 0.6 x 3.5 mm	

With insulating sleeves on cable lug connectors the voltage increases to 500 V. Current is limited by 2.8 mm cable lug connectors with 1 mm² conductor..

Technical data

Rated data	
Rated voltage	V
Max. voltage of clamp support & pluggable system	-
Rated current	A
for wire cross-section	mm ²
Rated impulse withstand voltage / Pollution severity	
Gauge to IEC 60947-1 / UL 94 flammability rating	
Approvals	
Clamped conductors (H05V/H07V)	
Solid / Stranded	mm ²
Flexible / Flexible with ferrule	mm ²
Tightening torque (clamping screw for copper conductors)	
Stripping length / Blade size	mm/-

Note

Ordering data

Version	
	dark beige
	blue
Note	

Accessories

Screwable cross-connection	
	2-pole
	10-pole
End plate / Partition plate	
	dark beige
	Blue
	dark beige
	Blue
End bracket	
	dark beige
Cover	
	With lightning flash symbol
	Blank, white
Identification systems	

For detailed information on other accessories and application in the online catalogue

WDU 2.5 FF 2*2.8

1 mm²

Spade connection left and right

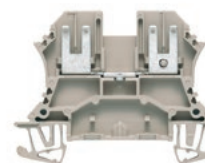

5.1 x 60 x 46.25	F2.8 F2.8	F2.8 F2.8
12 / 1		
...1		

IEC 61210, In accordance with IEC 60947-7-1

IEC	UL	CSA	EN 60079-7
500	300	300	
12	16	10	
1	AWG 22...14	AWG 26...12	
6 kV / 3			
/ V-0			

CE, ENEC, KEMA, UL, VDE

Rated connection	Plug-in connection

With insulating sleeves on cable lug connectors the voltage increases to 500 V. Current is limited by 2.8 mm cable lug connectors with 1 mm² conductor..

Type	Qty.	Order No.
WDU 2.5 FF 2X2.8	100	1021900000
Technical data refer to a 2.8 mm cable lug connector with 1 mm² conductor.		

Type	Qty.	Order No.
WDU 2.5 F 2X2.8	100	1021800000
2.5 mm ² conductor with ferrule with plastic collar, with collar optimised for diameter only (order No. 1333100000, QTY 500).		

Type	current	Qty.	Order No.
WQV 2.5/2	32 A	50	1053660000
WQV 2.5/10	32 A	20	1054460000
WAP 2.5-10		50	1050000000
WAP 2.5-10 BL		50	1050080000
WAP 16+35 WTW 2.5-10		20	1050100000
WAP 16+35 WTW 2.5-10 BL		20	1050180000
WEW 35/2		100	1061200000
WAD 4 GE BED		50	1072000000
WAD 4 WS		50	1072100000
DEK 5/5 MC NE WS		1000	1609801044
WS 12/5 MC NE WS		720	1609860000
DEK 5/5 MM WS		800	2007110000
WS 8/5 MM WS		800	2007150000

Type	current	Qty.	Order No.
WQV 2.5/2	32 A	50	1053660000
WQV 2.5/10	32 A	20	1054460000
WAP 2.5-10		50	1050000000
WAP 2.5-10 BL		50	1050080000
WAP 16+35 WTW 2.5-10		20	1050100000
WAP 16+35 WTW 2.5-10 BL		20	1050180000
WEW 35/2		100	1061200000
WAD 4 GE BED		50	1072000000
WAD 4 WS		50	1072100000
DEK 5/5 MC NE WS		1000	1609801044
WS 12/5 MC NE WS		720	1609860000
DEK 5/5 MM WS		800	2007110000
WS 8/5 MM WS		800	2007150000

Insulating sleeve for flat blade connector 2.8 mm, order no. 0386060000. Cross-connections, see section "W series accessories".

Insulating sleeve for flat blade connector 2.8 mm, order no. 0386060000. Cross-connections, see section "W series accessories".

Screw connection with clamping-yoke technology (W-Series)

Pluggable terminal blocks

WDK 2.5 F

2.5 mm²

Spade connection right

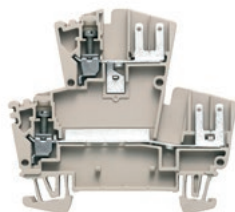

Width/Height/Depth	mm
max. current / max. cond. cross-section	A/mm ²
Max. clamping range	mm ²

5.1 x 69.5 x 62.5
12 / 4
0.13...4

IEC 61210, In accordance with IEC 60947-7-1

IEC	UL	CSA	EN 60079-7
400	300	300	
12	10	10	
2.5	AWG 22...12	AWG 26...12	
6 kV / 3			
A3 / V-0			

CE

Rated connection	Plug-in connection
0.5...4 / 1.5...4	
0.5...4 / 0.5...2.5	
0.4...0.6 Nm / (M 2.5)	
10 / 0.6 x 3.5 mm	

With insulating sleeves on cable lug connectors the voltage increases to 500 V. Current is limited by 2.8 mm cable lug connectors with 1 mm² conductor..

Technical data

Rated data	
Rated voltage	V
Max. voltage of clamp support & pluggable system	-
Rated current	A
for wire cross-section	mm ²
Rated impulse withstand voltage / Pollution severity	
Gauge to IEC 60947-1 / UL 94 flammability rating	
Approvals	

Clamped conductors (H05V/H07V)

Solid / Stranded	mm ²
Flexible / Flexible with ferrule	mm ²
Tightening torque (clamping screw for copper conductors)	
Stripping length / Blade size	mm/-

Note

Ordering data

Version	
	dark beige
	blue
Note	

Accessories

Screwable cross-connection	
	2-pole
	10-pole
End plate / Partition plate	
	dark beige
	Blue
	dark beige
	Blue
End bracket	
	dark beige
Cover	
	With lightning flash symbol
	Blank, white
Identification systems	

Type	Qty.	Order No.
WDK 2.5 F	100	1021600000
WDK 2.5 F BL	100	1021680000

2.5 mm² conductor with ferrule with plastic collar, with collar optimised for diameter only (order No. 1333100000, QTY 500).

Type	current	Qty.	Order No.
WQV 2.5/2	32 A	50	1053660000
WQV 2.5/10	32 A	20	1054460000
WAP WDK2.5		20	1059100000
WAP WDK2.5 BL		20	1059180000
WTW EN		20	1058800000
WEW 35/2		100	1061200000
WAD 4 GE BED		50	1072000000
WAD 4 WS		50	1072100000
DEK 5/5 MC NE WS		1000	1609801044
WS 8/5 MC NE WS		720	1640740000
DEK 5/5 MM WS		800	2007110000
WS 8/5 MM WS		800	2007150000

For detailed information on other accessories and application in the online catalogue

Insulating sleeve for flat blade connector 2.8 mm, order no. 0386060000. Cross-connections, see section "W series accessories".

WDK 2.5 FV

2.5 mm²

Spade connection right, both levels at one potential



5.1 x 69.5 x 62.5
12 / 4
0.13...4

IEC 61210, In accordance with IEC 60947-7-1

IEC	UL	CSA	EN 60079-7
400	300	300	
12	10	10	
2.5	AWG 22...12	AWG 26...12	
6 kV / 3			
A3 / V-0			

CE

Rated connection	Plug-in connection
0.5...4 / 1.5...4	
0.5...4 / 0.5...2.5	
0.4...0.6 Nm / (M 2.5)	
10 / 0.6 x 3.5 mm	

With insulating sleeves on cable lug connectors the voltage increases to 500 V. Current is limited by 2.8 mm cable lug connectors with 1 mm² conductor..

Type	Qty.	Order No.
WDK 2.5 FV	100	1022400000

2.5 mm² conductor with ferrule with plastic collar, with collar optimised for diameter only (order No. 1333100000, QTY 500).

Type	current	Qty.	Order No.
WQV 2.5/2	32 A	50	1053660000
WQV 2.5/10	32 A	20	1054460000
WAP WDK2.5		20	1059100000
WAP WDK2.5 BL		20	1059180000
WTW EN		20	1058800000
WEW 35/2		100	1061200000
WAD 4 GE BED		50	1072000000
WAD 4 WS		50	1072100000
DEK 5/5 MC NE WS		1000	1609801044
WS 8/5 MC NE WS		720	1640740000
DEK 5/5 MM WS		800	2007110000
WS 8/5 MM WS		800	2007150000

Insulating sleeve for flat blade connector 2.8 mm, order no. 0386060000. Cross-connections, see section "W series accessories".

WDK 2.5 FF

1 mm²

Spade connection left and right

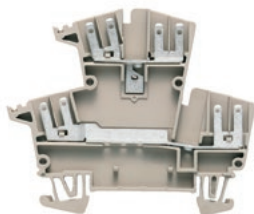

5.1 x 75.5 x 62.5

12 / 1

...1

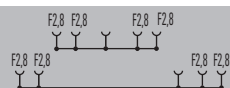

IEC 61210, In accordance with IEC
60947-7-1

IEC	UL	CSA	EN 60079-7
400		300	
12		10	
1		AWG 26...12	
	6 kV / 3		
	/ V-0		

CE

Rated connection **Plug-in connection**

With insulating sleeves on cable lug connectors the voltage increases to 500 V.
Current is limited by 2.8 mm cable lug connectors with 1 mm² conductor..

Type	Qty.	Order No.
WDK 2.5 FF	100	1021700000

Type	current	Qty.	Order No.
WQV 2.5/2	32 A	50	1053660000
WQV 2.5/10	32 A	20	1054460000
WAP WDK2.5		20	1059100000
WAP WDK2.5 BL		20	1059180000
WTW EN		20	1058800000
WEW 35/2		100	1061200000
WAD 4 GE BED		50	1072000000
WAD 4 WS		50	1072100000
DEK 5/5 MC NE WS		1000	1609801044
WS 8/5 MC NE WS		720	1640740000
DEK 5/5 MM WS		800	2007110000
WS 8/5 MM WS		800	2007150000

Insulating sleeve for flat blade connector 2.8 mm, order no. 0398060000. Cross-connections, see section "W series accessories".



Screw connection with clamping-yoke technology (W-Series)

Pluggable terminal blocks

WDU 1.5 BLZ 5.08 WQV

1.5 mm²

Screwable cross-connection

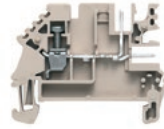

Width/Height/Depth	mm
max. current / max. cond. cross-section	A/mm ²
Max. clamping range	mm ²

5.08 x 49 x 37	WQV	BLZ 5.08
16 / 4		
0.13...4		

IEC 61210, In accordance with IEC 60947-7-1

IEC	UL	CSA	EN 60079-7
250	300	300	
16	20	10	
1.5	AWG 26...12	AWG 26...12	
4 kV / 3			
A3 / V-0			

CE, ENEC, UL, VDE

Rated connection	Plug-in connection
0.5...4 / 1.5...4	
0.5...4 / 0.5...2.5	
0.4...0.6 Nm / (M 2.5)	
10 / 0.6 x 3.5 mm	

Dimensions with female header BLZ: length 57.5 mm / height 55.5 mm.

Technical data

Rated data	
Rated voltage	V
Max. voltage of clamp support & pluggable system	-
Rated current	A
for wire cross-section	mm ²
Rated impulse withstand voltage / Pollution severity	
Gauge to IEC 60947-1 / UL 94 flammability rating	
Approvals	
Clamped conductors (H05V/H07V)	
Solid / Stranded	mm ²
Flexible / Flexible with ferrule	mm ²
Tightening torque (clamping screw for copper conductors)	
Stripping length / Blade size	mm/-

Note

Ordering data

Version	
	dark beige
Note	

Accessories

Pluggable cross-connection	
	2-pole
	10-pole
Screwable cross-connection	
	2-pole
	10-pole
End plate / Partition plate	
	Without peg
	With spigot
End bracket	
	dark beige
Mounting block for socket connector	
	Without peg
	With spigot
Plug-in connector	
Identification systems	
Miscellaneous accessories	
	Cover for unused pins
For detailed information on other accessories and application in the online catalogue	

WDU 1.5 BLZ 5.08 ZQV

1.5 mm²

Plug-in cross-connection

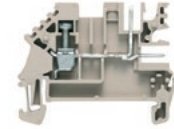

5.08 x 49 x 37	ZQV	BLZ 5.08
16 / 4		
0.13...4		

IEC 61984, In accordance with IEC 60947-7-1

IEC	UL	CSA	EN 60079-7
250	300	300	
16	20	20	
1.5	AWG 26...12	AWG 26...12	
4 kV / 3			
A3 / V-0			

CE, ENEC, UL, VDE

Rated connection	Plug-in connection
0.5...4 / 1.5...4	
0.5...4 / 0.5...2.5	
0.4...0.6 Nm / (M 2.5)	
10 / 0.6 x 3.5 mm	

Dimensions with female header BLZ: length 57.5 mm / height 55.5 mm.

Type	Qty.	Order No.
WDU 1.5/ZQV/BLZ 5.08	100	1784460000
2.5 mm ² conductor with wire-end ferrule with plastic collar, only with order no. 1333100000 (500 pieces).		

Type	Qty.	Order No.
WDU 1.5/BLZ 5.08	100	1577340000
WDU 1.5 BIA Order no. 1577260000 (100 pcs.). 2.5 mm ² conductor with wire-end ferrule with plastic collar, only with order no. 1333100000, QTY 500.		

Type	current	Qty.	Order No.
WQV 2.5/2	32 A	50	1053660000
WQV 2.5/10	32 A	20	1054460000
WAP WDU1.5/BLZ		50	1577330000
WAP WDU1.5/BLZ/ZA		50	1577320000
WEW 35/2		100	1061200000
WBB WDU1.5/BL...		10	1068160000
WBB ZA WDU1.5/BL 10/10		10	1068260000
DEK 5/5 MC NE WS		1000	1609801044
WS 12/5 MC SDR		144	1609870000
DEK 5/5 MM WS		800	2007110000
WS 8/5 MM WS		800	2007150000

Type	current	Qty.	Order No.
ZQV 2.5N/2	24 A	60	1527540000
ZQV 2.5N/10	24 A	20	1527690000
WAP WDU1.5/BLZ		50	1577330000
WAP WDU1.5/BLZ/ZA		50	1577320000
WEW 35/2		100	1061200000
WBB WDU1.5/BL...		10	1068160000
WBB ZA WDU1.5/BL 10/10		10	1068260000
BLZP 5.08HC/04/180 SN OR BX		90	1943600000
BLZP 5.08HC/06/180 SN OR BX		60	1943620000
BLZP 5.08HC/08/180 SN OR BX		42	1943640000
BLZP 5.08HC/04/180F SN OR BX		60	1944110000
BLZP 5.08HC/06/180F SN OR BX		42	1944130000
BLZP 5.08HC/08/180F SN OR BX		36	1944150000
DEK 5/5 MC NE WS		1000	1609801044
WS 12/5 MC SDR		144	1609870000
DEK 5/5 MM WS		800	2007110000
WS 8/5 MM WS		800	2007150000
SCHT 7		20	0517960000
ZGB 30		20	1611930000

The WBB with peg (order number 1068260000) can be used for direct mounting on both sides. Cross-connections, see section "W series accessories".

The WBB with peg (order number 1068260000) can be used for direct mounting on both sides. Cross-connections, see section "W series accessories".

WDK 2.5 BLZ/5.08

2.5 mm²

Double terminal pitch 5.08

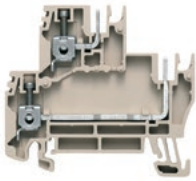

5.08 x 58 x 52.5
18 / 4
0.13...4

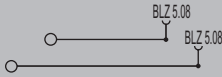

IEC 61984, In accordance with IEC 60947-7-1

IEC	UL	CSA	EN 60079-7
250	300	300	
16.5	20	20	
2.5	AWG 22...12	AWG 26...12	
4 kV / 3			
A3 / V-0			

CE Ⓢ Ⓡ Ⓜ Ⓛ

Rated connection	Plug-in connection
0.5...4 / 1.5...2.5	
0.5...4 / 0.5...2.5	
/ (M 2.5)	
10 / 0.6 x 3.5 mm	

Dimensions with female header BLZ: length 58 mm / height 63.5 mm

WDK 2.5 BLZ/5.08/ZA V

2.5 mm²

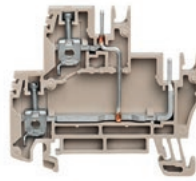

5.08 x 58 x 52.5
18 / 4
0.13...4

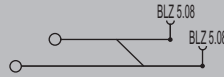

IEC 61984, In accordance with IEC 60947-7-1

IEC	UL	CSA	EN 60079-7
250	300	300	
16.5	20	20	
2.5	AWG 22...12	AWG 26...12	
4 kV / 3			
A3 / V-0			

CE Ⓢ Ⓡ Ⓜ Ⓛ

Rated connection	Plug-in connection
0.5...4 / 1.5...2.5	
0.5...4 / 0.5...2.5	
0.4...0.6 Nm / (M 2.5)	
10 / 0.6 x 3.5 mm	

Type	Qty.	Order No.
WDK 2.5/BLZ/5.08/ZA	100	1034400000
2.5 mm ² conductor with ferrule with plastic collar, with collar optimised for diameter only (order No. 1333100000, QTY 500).		

Type	Qty.	Order No.
WDK 2.5/BLZ/5.08/ZA V	100	1027410000

Type	current	Qty.	Order No.
WAP WDK2.5/BLZ/0.ZA	20	1070000000	
WAP WDK2.5/BLZ/M.ZA	20	1070100000	
WEW 35/1	50	1059000000	
WBB WDK2.5/BL5.08	10	1072660000	
WBB ZA WDK2.5/BL5.08	10	1072760000	
DEK 5/5 MC NE WS	1000	1609801044	
WS 8/5 MC NE WS	720	1640740000	
DEK 5/5 MM WS	800	2007110000	
WS 8/5 MM WS	800	2007150000	
WAD WDU1.5/BLZ/BLA	20	1577400000	

Type	current	Qty.	Order No.
WAP WDK2.5/BLZ/0.ZA	20	1070000000	
WAP WDK2.5/BLZ/M.ZA	20	1070100000	
WEW 35/1	50	1059000000	
WBB WDK2.5/BL5.08	10	1072660000	
WBB ZA WDK2.5/BL5.08	10	1072760000	
DEK 5/5 MC NE WS	1000	1609801044	
WS 8/5 MC NE WS	720	1640740000	
DEK 5/5 MM WS	800	2007110000	
WS 8/5 MM WS	800	2007150000	
WAD WDU1.5/BLZ/BLA	20	1577400000	

External cross-connector WQB A, see section on W-series Accessories "potential distribution".

Screw connection with clamping-yoke technology (W-Series)

Terminal blocks with electronic components

Universal range

A

WPO 4

4 mm²

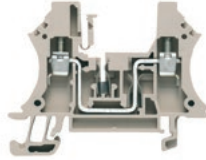

Width/Height/Depth	mm
max. current / max. cond. cross-section	A/mm ²
Max. clamping range	mm ²

6 x 60 x 46,5
32 / 4
0.13...4

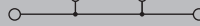

Technical data

Rated data	
Rated voltage	V
Max. voltage of clamp support & pluggable system	-
Rated current	A
for wire cross-section	mm ²
Rated impulse withstand voltage / Pollution severity	
Gauge to IEC 60947-1 / UL 94 flammability rating	
Approvals	
Clamped conductors (H05V/H07V)	
Solid / Stranded	mm ²
Flexible / Flexible with ferrule	mm ²
Tightening torque (clamping screw for copper conductors)	
Stripping length / Blade size	mm/-

Note

IEC 60947-1

IEC	UL	CSA	EN 60079-7
250	300	300	
32	10	10	
4	AWG 26...12	AWG 26...12	
	4 kV / 3		
	A3 / V-0		

CE

Rated connection	
0.5...4	
0.5...4 / 0.5...2.5	
8 / 0.6 x 3.5 mm	

The tightening torque is 2 Nm when connecting two conductors.

Ordering data

Version	dark beige
Note	

Type	Qty.	Order No.
WPO 4	50	1036000000

Accessories

Intermediate frame	Thickness 2.5 mm
Busbar	1 m
Identification systems	

Type	current	Qty.	Order No.
ZR WPO4 DB		20	1071100000
SSCH 7.3X1.2X1000		1	1071200000
DEK 5/6 MC NE WS		1000	1609820000
WS 12/5 MC NE WS		720	1609860000
DEK 5/6 MM WS		600	2007120000
WS 8/6 MM WS		600	2007160000

For detailed information on other accessories and application in the online catalogue

WPO 4 with varistor

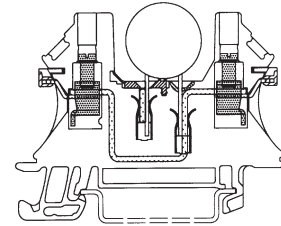

Weidmüller varistor terminals have been designed for the retrofitting of electronic components, e.g. varistors, diodes, gas discharge tubes, etc.

These "electronic terminals" no longer have to be configured prior to installation for subsequent delivery with soldered components which can no longer be distinguished.

The significant advantages of this design are:

- **Cost saving:**
Components can be changed quickly on site. Service requires only a visual inspection.
- **Clarity:**
Components are easy to distinguish.
- **Flexibility:**
Components can immediately be adapted to changed conditions.

Note:
Never change electronic components under load!

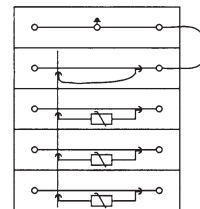

Overvoltages in a 3-phase supply discharged to earth via WPE 4 with the aid of varistors and a gas discharge tube.

WDUL 4/...

4 mm²

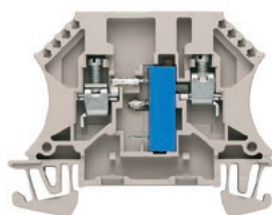

Width/Height/Depth	mm
max. current / max. cond. cross-section	A/mm ²
Max. clamping range	mm ²

6.5 x 60 x 46.5
6 / 6
0.13...6

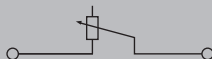

Technical data

Rated data	
Rated voltage	-
Max. voltage of clamp support & pluggable system	-
Rated current	A
for wire cross-section	mm ²
Rated impulse withstand voltage / Pollution severity	
Gauge to IEC 60947-1 / UL 94 flammability rating	
Approvals	
Clamped conductors (H05V/H07V)	
Solid / Stranded	mm ²
Flexible / Flexible with ferrule	mm ²
Tightening torque (clamping screw for copper conductors)	
Stripping length / Blade size	mm/-

IEC 60947-7-1

IEC	UL	CSA	EN 60079-7

CE EMC

Rated connection	
0.5...6 / 1.5...6	
0.5...4 / 0.5...2.5	
9 / 0.6 x 3.5 mm	

Note

Ordering data

Version	
	10 Ω
	100 Ω
	500 Ω
	1 kΩ
	5 kΩ
	10 kΩ
	50 kΩ
	500 kΩ
	without potentiometer

Note

Accessories

End plate / Partition plate	
	dark beige
	dark beige
End bracket	
	dark beige
Screwdriver	
	With "swifty set" cutting device
	Standard
Shield bus	
Identification systems	

Type	Qty.	Order No.
WDUL 4/10	10	1027000000
WDUL 4/100	10	1027300000
WDUL 4/500	10	1027400000
WDUL 4/1K	10	1027500000
WDUL 4/5K	10	1027600000
WDUL 4/10K	10	1027700000
WDUL 4/50K	10	1027800000
WDUL 4/500K	10	1028000000
WDUL 4	10	8161820000

Type	current	Qty.	Order No.
WAP 2.5-10		50	1050000000
WAP 16+35 WTW 2.5-10		20	1050100000
WEW 35/2		100	1061200000
SWIFTY SET		1	9006060000
SDS 0.6X3.5X100		1	9008330000
LS 2.8 WDU2.5-10		100	1056400000
DEK 5/5 MC NE WS		1000	1609801044

For detailed information on other accessories and application in the online catalogue

Technical data for the 10 Ω compensating resistor

- Resistor material: "Cermet"
Resistor setting range: 0...30 Ω
Wave form: linear
Temperature coefficient: 100 ppm/°C
Mechanical lifespan: 200 operations without permissible deviations, across the entire resistance range
Resistance change per spindle turn: ≈ 0,4 Ω
Rated output for total resistance: 1 watt at 70 °C
Rated current: 300 mA
Ambient temperature: -55 °C to +70 °C
Ingress (seal) protection:
1) Leak tested in water at 70 °C without bubble formation
2) Storage in SFW 2.0 S, acc. to DIN 50018, 9 cycles

Capacity expressed in % of rated load

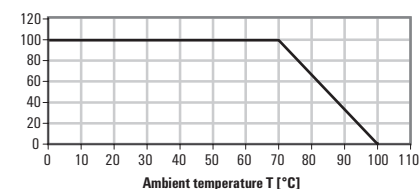

Screw connection with clamping-yoke technology (W-Series)

Terminal blocks with electronic components

Universal range

A

WDK 2.5/D

2.5 mm²

Reverse polarity protection

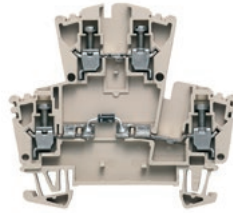

5.1 x 69 x 62.5
10 / 4
0.05...4

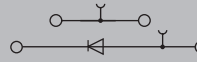

WDK 2.5/D/1

2.5 mm²

Suppression circuit e. g. for contactor

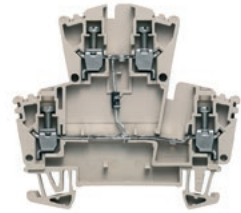

5.1 x 69 x 62.5
10 / 4
0.05...4



Width/Height/Depth mm
max. current / max. cond. cross-section A/mm²
Max. clamping range mm²

Technical data

Rated data	
Rated voltage	-
Rated current	A
for wire cross-section	mm ²
Rated impulse withstand voltage / Pollution severity	
Gauge to IEC 60947-1 / UL 94 flammability rating	
Approvals	
Clamped conductors (H05V/H07V)	
Solid / Stranded	mm ²
Flexible / Flexible with ferrule	mm ²
Tightening torque (clamping screw for copper conductors)	
Stripping length / Blade size	mm/-
Note	

Ordering data

Version	
	dark beige
	dark beige (red LED)
	dark beige (green LED)
Note	

Accessories

Screwable cross-connection	
	2-pole
	10-pole
End plate / Partition plate	
	dark beige
End bracket	
	dark beige
Screwdriver	
	With "swifty set" cutting device
	Standard
Identification systems	

IEC 60947-7-1

IEC	UL	CSA	EN 60079-7
	300		
10	20		
2.5	AWG 22...12		
6 kV / 3			
A3 / V-0			

CE ENEC SAA

Rated connection	
0.5...4 / 1.5...4	mm ²
0.5...4 / 0.5...2.5	mm ²
0.4...0.6 Nm / (M 2.5)	
10 / 0.6 x 3.5 mm	

Rated current is 10 A for continuous busbars only. Diode 1 N 4007

Type	Qty.	Order No.
WDK 2.5 1D	25	8025610000
2.5 mm ² conductor with ferrule with plastic collar, with collar optimised for diameter only (order No. 1333100000, QTY 500).		

IEC 60947-7-1

IEC	UL	CSA	EN 60079-7
400	300	300	
10	20	1	
2.5	AWG 22...12	AWG 26...12	
6 kV / 3			
A3 / V-0			

CE ENEC SAA

Rated connection	
0.5...4 / 1.5...4	mm ²
0.5...4 / 0.5...2.5	mm ²
0.4...0.6 Nm / (M 2.5)	
10 / 0.6 x 3.5 mm	

Rated current is 10 A for continuous busbars only. Diode 1 N 4007

Type	Qty.	Order No.
WDK 2.5 1D A.1	25	1023400000
2.5 mm ² conductor with ferrule with plastic collar, with collar optimised for diameter only (order No. 1333100000, QTY 500).		

Type	current	Qty.	Order No.
WQV 2.5/2	32 A	50	1053660000
WQV 2.5/10	32 A	20	1054460000
WAP WDK2.5			
		20	1059100000
WEW 35/2			
		100	1061200000
SWIFTY SET			
		1	9006060000
SDS 0.6X3.5X100		1	9008330000
DEK 5/5 MC NE WS		1000	1609801044
WS 8/5 MC NE WS		720	1640740000
DEK 5/5 MM WS		800	2007110000
WS 8/5 MM WS		800	2007150000

Type	current	Qty.	Order No.
WQV 2.5/2	32 A	50	1053660000
WQV 2.5/10	32 A	20	1054460000
WAP WDK2.5			
		20	1059100000
WEW 35/2			
		100	1061200000
SWIFTY SET			
		1	9006060000
SDS 0.6X3.5X100		1	9008330000
DEK 5/5 MC NE WS		1000	1609801044
WS 8/5 MC NE WS		720	1640740000
DEK 5/5 MM WS		800	2007110000
WS 8/5 MM WS		800	2007150000

For detailed information on other accessories and application in the online catalogue

Cross-connections, see section "W series accessories".

Cross-connections, see section "W series accessories".

WDK 2.5/D/2

2.5 mm²

Suppression circuit e. g. for contactor

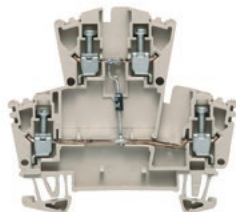

5.1 x 69 x 62.5
10 / 4
0.05...4



IEC 60947-7-1

IEC	UL	CSA	EN 60079-7
400	300	300	
10	20	1	
2.5	AWG 22...12	AWG 26...12	
6 kV / 3			
A3 / V-0			

CE

Rated connection

0.5...4 / 1.5...4
0.5...4 / 0.5...2.5
0.4...0.6 Nm / (M 2.5)
10 / 0.6 x 3.5 mm

Rated current is 10 A for continuous busbars only. **Diode 1 N 4007**

Type	Qty.	Order No.
WDK 2.5 1D A.2	25	1023300000

2.5 mm² conductor with ferrule with plastic collar, with collar optimised for diameter only (order No. 1333100000, QTY 500).

Type	current	Qty.	Order No.
WQV 2.5/2	32 A	50	1053660000
WQV 2.5/10	32 A	20	1054460000
WAP WDK2.5		20	1059100000
WEW 35/2		100	1061200000
SWIFTY SET		1	9006060000
SDS 0.6X3.5X100		1	9008330000
DEK 5/5 MC NE WS		1000	1609801044
WS 8/5 MC NE WS		720	1640740000
DEK 5/5 MM WS		800	2007110000
WS 8/5 MM WS		800	2007150000

Cross-connections, see section "W series accessories".

WDK 2.5/D/3

2.5 mm²

5.1 x 69 x 62.5



5.1 x 69 x 62.5
10 / 4
0.05...4

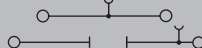

IEC 60947-7-1

IEC	UL	CSA	EN 60079-7
400			
10			
2.5			
6 kV / 3			
A3 / V-0			

CE

Rated connection

0.5...4 / 1.5...4
0.5...4 / 0.5...2.5
0.4...0.6 Nm / (M 2.5)
10 / 0.6 x 3.5 mm

Type	Qty.	Order No.
WDK 2.5/D/3	100	1023100000

2.5 mm² conductor with wire end ferrule plus plastic collar only with collar optimised for diameter (order No. 1333100000, 500 pcs)

Type	current	Qty.	Order No.
WQV 2.5/2	32 A	50	1053660000
WQV 2.5/10	32 A	20	1054460000
WAP WDK2.5		20	1059100000
WEW 35/2		100	1061200000
SWIFTY SET		1	9006060000
SDS 0.6X3.5X100		1	9008330000
DEK 5/5 MC NE WS		1000	1609801044
WS 8/5 MC NE WS		720	1640740000
DEK 5/5 MM WS		800	2007110000
WS 8/5 MM WS		800	2007150000

Cross-connections, see section "W series accessories".

WDK 2.5/D/4

2.5 mm²

Lamp test circuits

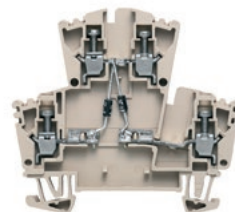

5.1 x 69 x 62.5
10 / 4
0.05...4

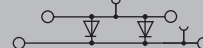

IEC 60947-7-1

IEC	UL	CSA	EN 60079-7
400	300		
10	20		
2.5	AWG 22...12		
6 kV / 3			
A3 / V-0			

CE

Rated connection

0.5...4 / 1.5...4
0.5...4 / 0.5...2.5
0.4...0.6 Nm / (M 2.5)
10 / 0.6 x 3.5 mm

Rated current is 10 A for continuous busbars only. **Diode 1 N 4007**

Type	Qty.	Order No.
WDK 2.5 2D 1.A	25	8014670000

2.5 mm² conductor with ferrule with plastic collar, with collar optimised for diameter only (order No. 1333100000, QTY 500).

Type	current	Qty.	Order No.
WQV 2.5/2	32 A	50	1053660000
WQV 2.5/10	32 A	20	1054460000
WAP WDK2.5		20	1059100000
WEW 35/2		100	1061200000
SWIFTY SET		1	9006060000
SDS 0.6X3.5X100		1	9008330000
DEK 5/5 MC NE WS		1000	1609801044
WS 8/5 MC NE WS		720	1640740000
DEK 5/5 MM WS		800	2007110000
WS 8/5 MM WS		800	2007150000

Cross-connections, see section "W series accessories".



Screw connection with clamping-yoke technology (W-Series)

Terminal blocks with electronic components

WDK 2.5/D/5

2.5 mm²

Lamp test circuits

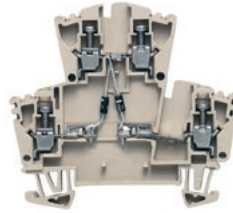

Width/Height/Depth	mm
max. current / max. cond. cross-section	A/mm ²
Max. clamping range	mm ²

5.1 x 69 x 62.5
10 / 4
0.05...4



Technical data

Rated data	
Rated voltage	V
Rated current	A
for wire cross-section	mm ²
Rated impulse withstand voltage / Pollution severity	
Gauge to IEC 60947-1 / UL 94 flammability rating	
Approvals	
Clamped conductors (H05V/H07V)	
Solid / Stranded	mm ²
Flexible / Flexible with ferrule	mm ²
Tightening torque (clamping screw for copper conductors)	
Stripping length / Blade size	mm/-

Note

Ordering data

Version	
	dark beige
	dark beige (red LED)
	dark beige (green LED)

Note

Accessories

Screwable cross-connection	
	2-pole
	10-pole
End plate / Partition plate	
	dark beige
End bracket	
	dark beige
Screwdriver	
	With "swifty set" cutting device
	Standard
Identification systems	

For detailed information on other accessories and application in the online catalogue

WDK 2.5/D/6

2.5 mm²

Lamp test circuits



5.1 x 69 x 62.5
10 / 4
0.05...4



IEC 60947-7-1

IEC	UL	CSA	EN 60079-7
400	300	300	
10	20	10	
2.5	AWG 22...12	AWG 26...12	
6 kV / 3			
A3 / V-0			

CE

Rated connection

0.5...4 / 1.5...4
0.5...4 / 0.5...2.5
0.4...0.6 Nm / (M 2.5)
10 / 0.6 x 3.5 mm

Rated current is 10 A for continuous busbars only.

Type	Qty.	Order No.
WDK 2.5 2D	25	1023500000

2.5 mm² conductor with ferrule with plastic collar, with collar optimised for diameter only (order No. 1333100000, QTY 500).

IEC 60947-7-1

IEC	UL	CSA	EN 60079-7
400	300	300	
10	20	10	
2.5	AWG 22...12	AWG 26...12	
6 kV / 3			
A3 / V-0			

CE

Rated connection

0.5...4 / 1.5...4
0.5...4 / 0.5...2.5
0.4...0.6 Nm / (M 2.5)
10 / 0.6 x 3.5 mm

Rated current is 10 A for continuous busbars only. Diode 1 N 4007

Type	Qty.	Order No.
WDK 2.5 2D 2 A	25	1022600000

2.5 mm² conductor with ferrule with plastic collar, with collar optimised for diameter only (order No. 1333100000, QTY 500).

Type	current	Qty.	Order No.
WQV 2.5/2	32 A	50	1053660000
WQV 2.5/10	32 A	20	1054460000

WAP WDK2.5	20	1059100000
------------	----	------------

WEW 35/2	100	1061200000
----------	-----	------------

SWIFTY SET	1	9006060000
------------	---	------------

SDS 0.6X3.5X100	1	9008330000
-----------------	---	------------

DEK 5/5 MC NE WS	1000	1609801044
------------------	------	------------

WS 8/5 MC NE WS	720	1640740000
-----------------	-----	------------

DEK 5/5 MM WS	800	2007110000
---------------	-----	------------

WS 8/5 MM WS	800	2007150000
--------------	-----	------------

Type	current	Qty.	Order No.
WQV 2.5/2	32 A	50	1053660000
WQV 2.5/10	32 A	20	1054460000

WAP WDK2.5	20	1059100000
------------	----	------------

WEW 35/2	100	1061200000
----------	-----	------------

SWIFTY SET	1	9006060000
------------	---	------------

SDS 0.6X3.5X100	1	9008330000
-----------------	---	------------

DEK 5/5 MC NE WS	1000	1609801044
------------------	------	------------

WS 8/5 MC NE WS	720	1640740000
-----------------	-----	------------

DEK 5/5 MM WS	800	2007110000
---------------	-----	------------

WS 8/5 MM WS	800	2007150000
--------------	-----	------------

Cross-connections, see section "W series accessories".

WDK 2.5/D

2.5 mm²

For installing electronic components



5.1 x 69.5 x 62.5
10 / 4
0.05...4

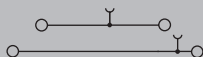

IEC 60947-7-1

IEC	UL	CSA	EN 60079-7
400			
10			
2.5			
	6 kV / 3		
	A3 / V-0		

CE

Rated connection

0.5...4 / 1.5...4
0.5...4 / 0.5...2.5
0.4...0.6 Nm / (M 2.5)
10 / 0.6 x 3.5 mm

Rated current is 10 A for continuous busbars only.

Type	Qty.	Order No.
WDK 2.5/D	100	1023200000

2.5 mm² conductor with ferrule with plastic collar, with collar optimised for diameter only (order No. 1333100000, QTY 500).

Type	current	Qty.	Order No.
WQV 2.5/2	32 A	50	1053660000
WQV 2.5/10	32 A	20	1054460000
WAP WDK2.5		20	1059100000
WEW 35/2		100	1061200000
SWIFTY SET		1	9006060000
SDS 0.6X3.5X100		1	9008330000
DEK 5/5 MC NE WS		1000	1609801044
WS 8/5 MC NE WS		720	1640740000
DEK 5/5 MM WS		800	2007110000
WS 8/5 MM WS		800	2007150000

WDK 2.5 LD +/-

2.5 mm²

DC voltage indicator +/-

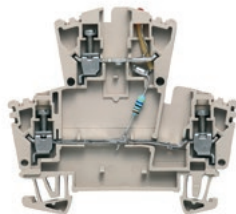

5.1 x 69 x 62.5
10 / 4
0.13...4



IEC 60947-7-1

IEC	UL	CSA	EN 60079-7
24			
2.5			
	0.8 kV / 3		
	A3 / V-0		

CE

Rated connection

0.5...4 / 1.5...4
0.5...4 / 0.5...2.5
0.4...0.6 Nm / (M 2.5)
10 / 0.6 x 3.5 mm

Type	Qty.	Order No.
WDK 2.5 LD RT 24VDC +/-	25	1023600000
WDK 2.5 LD/GN 1R 24VDC	25	8023610000

2.5 mm² conductor with ferrule with plastic collar, with collar optimised for diameter only (order No. 1333100000, QTY 500).

Type	current	Qty.	Order No.
WQV 2.5/2	32 A	50	1053660000
WQV 2.5/10	32 A	20	1054460000
WAP WDK2.5		20	1059100000
WEW 35/2		100	1061200000
SWIFTY SET		1	9006060000
SDS 0.6X3.5X100		1	9008330000
DEK 5/5 MC NE WS		1000	1609801044
WS 8/5 MC NE WS		720	1640740000
DEK 5/5 MM WS		800	2007110000
WS 8/5 MM WS		800	2007150000

Cross-connections, see section "W series accessories".

WDK 2.5 LD - +

2.5 mm²

DC voltage indicator - / +

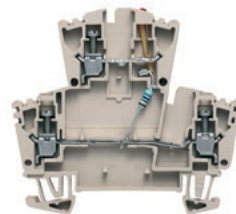

5.1 x 69 x 62.5
10 / 4
0.13...4



IEC 60947-7-1

IEC	UL	CSA	EN 60079-7
24			
2.5			
	0.8 kV / 3		
	A3 / V-0		

CE

Rated connection

0.5...4 / 1.5...4
0.5...4 / 0.5...2.5
0.4...0.6 Nm /
10 / 0.6 x 3.5 mm

Type	Qty.	Order No.
WDK 2.5 LD RT 24VDC - +	25	8023630000
WDK 2.5 LD GR 1R 24VDC	25	8010040000

2.5 mm² conductor with ferrule with plastic collar, with collar optimised for diameter only (order No. 1333100000, QTY 500).

Type	current	Qty.	Order No.
WQV 2.5/2	32 A	50	1053660000
WQV 2.5/10	32 A	20	1054460000
WAP WDK2.5		20	1059100000
WEW 35/2		100	1061200000
SWIFTY SET		1	9006060000
SDS 0.6X3.5X100		1	9008330000
DEK 5/5 MC NE WS		1000	1609801044
WS 8/5 MC NE WS		720	1640740000
DEK 5/5 MM WS		800	2007110000
WS 8/5 MM WS		800	2007150000

Cross-connections, see section "W series accessories".



Screw connection with clamping-yoke technology (W-Series)
Mini terminal blocks for enclosure wiring

Universal range

A

MK 2/12

2.5 mm²

MK 3/2...12

2.5 mm²

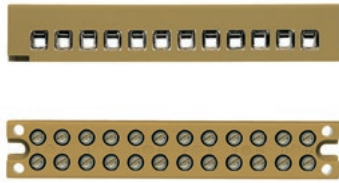

Width/Height/Depth	mm
max. current / max. cond. cross-section	A/mm ²
Max. clamping range	mm ²

15 x 86 x 15
24 / 4
0.2...4

91.25 x 15 x 16.1
24 / 4
0.33...4

Technical data

Rated data	
Rated voltage	
Rated current	
for wire cross-section	
Rated impulse withstand voltage / Pollution severity	
Gauge to IEC 60947-1 / UL 94 flammability rating	
Approvals	
Clamped conductors (H05V/H07V)	
Solid / Stranded	
Flexible / Flexible with ferrule	
Tightening torque (clamping screw for copper conductors)	
Stripping length / Blade size	

IEC 60947-7-1

IEC	UL	CSA	EN 60079-7
125	300	300	
24	10	10	
2.5	AWG 24...12	AWG 24...12	
2.5 kV / 3			
A2 / V-2			

CE CB IEC KEMA VDE

Rated connection	
0.5...4 / 1.5...2.5	
0.5...2.5 / 0.5...1.5	
/ (M 2.5)	
5 / 0.6 x 3.5 mm	

IEC 60947-7-1

IEC	UL	CSA	EN 60079-7
400	300	300	
24	20	25	
2.5	AWG 22...12	AWG 22...12	
6 kV / 3			
A2 / 5VA			

CE CB IEC KEMA VDE

Rated connection	
0.5...4 / 1.5...2.5	
0.5...2.5 / 0.5...1.5	
/ (M 2.5)	
5 / 0.6 x 3.5 mm	

Note

Ordering data

Order data, sorting catalogue 1/SAK	
2-pin	
3-pin	
4-pin	
5-pin	
6-pin	
7-pin	
8-pin	
10-pin	
12-pin	
16-pin	

Type	Height	Mounting	Qty.	Order No.
MK 2/12	86	80	50	0241260000

Type	Height	Mounting	Qty.	Order No.
MK 3/2	15	18.5	100	0273820000
MK 3/3	15	18.5	50	0273920000
MK 3/4	15	18.5	50	0274020000
MK 3/5	15	18.5	50	0274120000
MK 3/6	15	37	50	0274220000
MK 3/7	15	37	50	0274320000
MK 3/8	15	55.5	25	0274420000
MK 3/10	15	74	20	0274620000
MK 3/12	15	92.5	20	0243520000

Note

For detailed information on other accessories and application in the online catalogue

MK 4/16

2.5 mm²

MK 6/2...6/6

6 mm²



17 x 103 x 16
24 / 4
0.2...4

23 x 23.5 x 22
41 / 6
0.33...6

IEC 60947-7-1

IEC	UL	CSA	EN 60079-7
400	150	150	
24	15	15	
2.5	AWG 24...12	AWG 22...12	
6 kV / 3			
A2 / 5VA			

IEC 60947-7-1

IEC	UL	CSA	EN 60079-7
690	300	300	
41	30	40	
6	AWG 22...10	AWG 22...10	
8 kV / 3			
A3 / 5VA			

CE

Rated connection

0.5...4 / 1.5...2.5

0.5...2.5 / 0.5...1.5

/(M 2.5)

5 / 0.6 x 3.5 mm

CE

Rated connection

0.5...6 / 1.5...6

0.5...6 / 0.5...4

/(M 4)

9 / 4.0 x 0.8 mm

Type	Height	Mounting	Qty.	Order No.
MK 4/16	103	85.5	20	0244220000

Type	Height	Mounting	Qty.	Order No.
MK 6/2	23.5		50	0620420000
MK 6/3	36.5	13	50	0620320000
MK 6/4	49.5	26	20	0620220000
MK 6/6	75.5	52	20	0620120000



Screw connection with clamping-yoke technology (W-Series)
Mini terminal blocks for enclosure wiring

Universal range

A

MK 5/2 0.DE

2.5 mm²

KS 2...10

2.5 mm²



Width/Height/Depth	mm
max. current / max. cond. cross-section	A/mm ²
Max. clamping range	mm ²

18 x 40 x 14.2
24 / 4
0.2...4

25 x 138 x 17.5
24 / 4
0.2...4

Technical data

Rated data	
Rated voltage	
Rated current	
for wire cross-section	
Rated impulse withstand voltage / Pollution severity	
Gauge to IEC 60947-1 / UL 94 flammability rating	
Approvals	
Clamped conductors (H05V/H07V)	
Solid / Stranded	
Flexible / Flexible with ferrule	
Tightening torque (clamping screw for copper conductors)	
Stripping length / Blade size	

IEC	UL	CSA	EN 60079-7
500		300	
24		25	
2.5		AWG 20...14	
		6 kV / 3	
		A2 / 5VA	
CE			
Rated connection			
0.5...4 / 1.5...2.5			
0.5...2.5 / 0.5...1.5			
/ (M 2.5)			
5 / 0.6 x 3.5 mm			

IEC 60947-7-1

IEC	UL	CSA	EN 60079-7
500	300	300	
24	20	25	
2.5	AWG 24...12	AWG 24...12	
		6 kV / 3	
		A2 / 5VA	
CE			
Rated connection			
0.5...4 / 1.5...2.5			
0.5...2.5 / 0.5...1.5			
/ (M 3)			
8 / 4.0 x 0.8 mm			

Note

Ordering data

Order data, sorting catalogue 1/SAK	
2-pin	
3-pin	
4-pin	
6-pin	
10-pin	
12-pin	

Type	Height	Mounting	Qty.	Order No.
MK 5/2 0.DE	40	32	100	0243820000

Type	Height	Mounting	Qty.	Order No.
KS 2 0.D2	42	32	100	0134420000
KS 4 0.D4	66	56	50	0140320000
KS 6 0.D6	90	80	50	0140620000
KS 10 0.D10	138	128	20	0141620000

Note

Accessories

Lid / cover	Type	Qty.	Order No.
	D 2 MK5/2 PA/NA	50	0244060000

Type	Qty.	Order No.
D2 KS2 TP	100	0134500000
D4 KS4 TP	50	0140500000
D6 KS6 TP	50	0140800000
D10 KS10 TP	20	0141800000

Type	Qty.	Order No.
D2 KS2 TP	100	0134500000
D4 KS4 TP	50	0140500000
D6 KS6 TP	50	0140800000
D10 KS10 TP	20	0141800000

For detailed information on other accessories and application in the online catalogue

BK 2...12

4 mm²



22 x 92 x 20
32 / 4
0.33...4

IEC 60947-7-1

IEC	UL	CSA	EN 60079-7
400	150	300	
32	20	10	
4	AWG 26...12	AWG 22...12	
6 kV / 3			
A3 / V-0, 5VA			

CE

Rated connection

0.5...4 / 1.5...4

0.5...4 / 0.5...4

/ (M 3)

8 / 4.0 x 0.8 mm

Two solid (single-core) conductors of equal cross-section (0.5 ... 1.5 mm²) can be connected.

Type	Height	Mounting	Qty.	Order No.
BK 2 CRN	20		100	0624720000
BK 3 CRN	31	11	100	0624920000
BK 4 CRN	38	18	100	0625120000
BK 6 CRN	52	32	50	0625220000
BK 12 CRN	92	72.5	25	0625320000



Screw connection with clamping-yoke technology (W-Series)
Mini terminal blocks for enclosure wiring

Universal range

A

BK 2...12/E

4 mm²

Solid / stranded
 Flexible / flexible with wire-end ferrule



MK 3/2...12/E

2.5 mm²

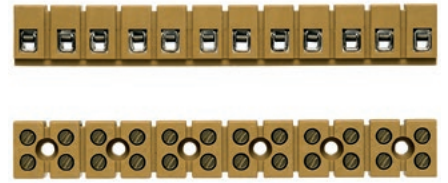

Width/Height/Depth	mm
max. current / max. cond. cross-section	A/mm ²
Max. clamping range	mm ²

22 x 92 x 20
32 / 4
0.33...4

15 x 110 x 16.1
24 / 4
0.33...4

Technical data

Rated data	
Rated voltage	
Rated current	
for wire cross-section	
Rated impulse withstand voltage / Pollution severity	
Gauge to IEC 60947-1 / UL 94 flammability rating	
Approvals	
Clamped conductors (H05V/H07V)	
Solid / Stranded	
Flexible / Flexible with ferrule	
Tightening torque (clamping screw for copper conductors)	
Stripping length / Blade size	
Note	

IEC 60947-7-1				Ex e III	
				2 G D	
IEC	UL	CSA	EN 60079-7		
400	150	300	275		
32	20	10	28		
4	AWG 26...12	AWG 22...12	4 mm ²		
6 kV / 3					
A3 / V-0, 5VA					
		BAS 98ATEX3084 U			
Rated connection					
0.5...4 / 1.5...4					
0.5...4 / 0.5...4					
/ (M 3)					
8 / 4.0 x 0.8 mm					
Two solid (single-core) conductors of equal cross-section (0.5 ... 1.5 mm ²) can be connected.					

IEC 60947-7-1				Ex e III	
				2 G D	
IEC	UL	CSA	EN 60079-7		
400	300	300	275		
24	20	25	21		
2.5	AWG 22...12	AWG 22...12	2.5 mm ²		
6 kV / 3					
A2 / 5VA					
		BAS 99ATEX2124 U			
Rated connection					
0.5...4 / 1.5...2.5					
0.5...2.5 / 0.5...1.5					
/ (M 2.5)					
5 / 0.6 x 3.5 mm					

Ordering data

Order data, sorting catalogue 1/SAK	
2-pin	
3-pin	
4-pin	
5-pin	
6-pin	
8-pin	
12-pin	
Note	

Type	Height	Mounting	Qty.	Order No.
BK 2/E	20		100	7906040000
BK 3/E	31	11	100	7906060000
BK 4/E	38	18	100	7906080000
BK 6/E	52	32	50	7906090000
BK 12/E	92	72.5	25	7906100000

*DU = feed-through terminals, PE = PE terminals

Type	Height	Mounting	Qty.	Order No.
MK 3/2/E	15	18.5	100	7906110000
MK 3/3/E	15	18.5	50	7906120000
MK 3/4/E	15	18.5	50	7906130000
MK 3/6/E	15	37	50	7906150000
MK 3/8/E	15	55.5	25	7906170000
MK 3/12/E	110	92.5	20	7906210000

Accessories

Lid / cover		
Type	Qty.	Order No.
D2 KS2 TP	100	0134500000
D4 KS4 TP	50	0140500000
D6 KS6 TP	50	0140800000
D10 KS10 TP	20	0141800000

Lid / cover		
Type	Qty.	Order No.
D2 KS2 TP	100	0134500000
D4 KS4 TP	50	0140500000
D6 KS6 TP	50	0140800000
D10 KS10 TP	20	0141800000

For detailed information on other accessories and application in the online catalogue

For detailed information on other accessories and application in the online catalogue

For detailed information on other accessories and application in the online catalogue

MK 6/2...6/E

6 mm²



23 x 23.5 x 22
41 / 6
0.33...6

IEC 60947-7-1 Ex e IIII 2 G D

IEC	UL	CSA	EN 60079-7
690	300		440
41	30		36
6	AWG 22...10		6 mm ²

8 kV / 3
A3 / 5VA

BAS 99ATEX2123 U

Rated connection

0.5...6 / 1.5...6

0.5...6 / 0.5...4

/ (M 4)

9 / 4.0 x 0.8 mm

Type	Height	Mounting	Qty.	Order No.
MK 6/2/E	23.5		50	7906220000
MK 6/3/E	36.5	13	50	7906230000
MK 6/4/E	49.5	26	20	7906240000
MK 6/5/E	62.5	26	20	7906250000
MK 6/6/E	75.5	52	20	7906260000



ZQV plug-in cross-connection

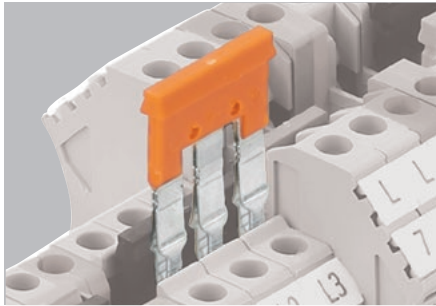

Weidmüller is the leading manufacturer of plug-in cross connection systems for screw clamp terminals. The plug-in cross-connections stand out with their easy handling and quick assembly, resulting in considerable time savings compared to screwed assembly solutions. This also ensures that all poles remain securely in contact.

Assembly / Technical information

- The ZQV is pressed into the cross-connection channel by hand.
- **Important!** Ensure that the ZQV is pressed right in. The cross-connection must not protrude out of the cross-connection channel.
- To replace or remove, simply lever out with a screwdriver.
- Reduced rated voltage 400 V
- Different colours can be used to mark different potential
- **Important!** The contact elements must not be deformed

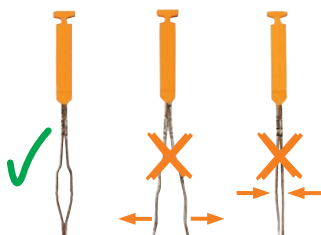

In one cross-connection channel

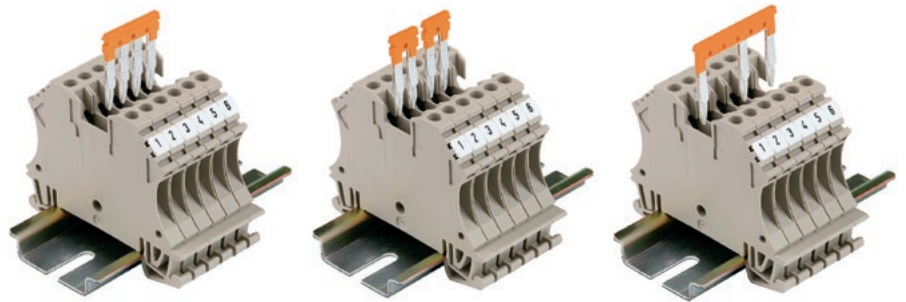

In two cross-connection channels

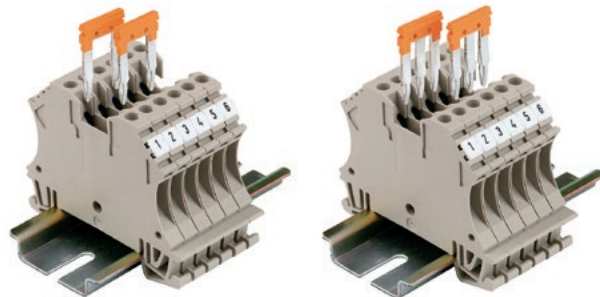

Possible cross-connections of terminals of the same type with corresponding cross-connectors

Terminal type	Cross-connector	single	adjacent	bridging	parallel bridging	parallel lengthening
Standard						
WDU 1.5/ R3.5	ZQV 1.5/ R3.5	•	•	•		
WDK 1.5/ R3.5	ZQV 1.5/ R3.5	•	•	•		
WDU 2.5/1.5/ZR	ZQV 2.5N	•	•	•	•	•
WDU 2.5	ZQV 2.5N	•	•	•	•	•
WDK 2.5 ZQV	ZQV 2.5N	•	•	•		
WTR 2.5/ZZ	ZQV 2.5	•	•	•		
WDU 4	ZQV 4N	•	•	•	•	•
WTR 4...	ZQV 4N	•	•	•		
WDU/PE/4ZZ/ZR	ZQV 4N	•	•	•	•	•
WTR 4/ZZ/ZR	ZQV 4N	•	•	•		
Compact						
WDU 2.5N ZQV	ZQV 2.5N	•	•	•	•	•
WDK 2.5N...	ZQV 2.5N	•	•	•		
WDK 2.5N PE	ZQV 2.5N	•	•	•		
WDU 4N	ZQV 4N	•	•	•	•	•
WDK 4N...	ZQV 4N	•	•	•		
WDK 4N PE	ZQV 4N	•	•	•		

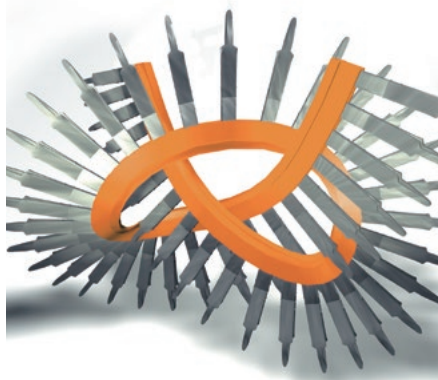

Continuous cross-connection

ZQV 2.5N/20 (20-pole) and ZQV 4N/20 (20-pole) are ideal for shortening (e.g. with tool KT ZQV - 9002170000) to produce customised configurations with the required number of poles.

More than 20 poles in a row are not recommended because of the resulting tolerances in the terminals.

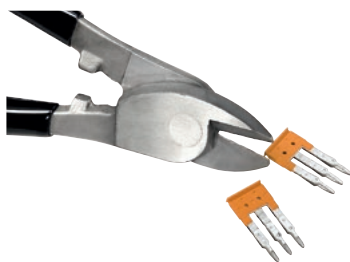

Special features of

WDU 2.5, WDU 4 und WDU 2.5/1.5/ZR

- Parallel distribution of 3 potentials
Important! Rated voltage reduced to 125 V!
- Parallel distribution of 2 potentials
Important! Only when using the outer cross-connection holes at 400 V
- The middle cross-connection hole can be used for either ZQV or WQV

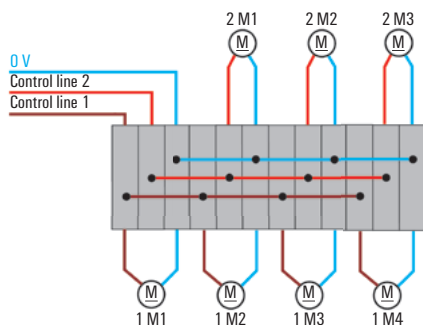

Important! By using manually cut ZQV and cross-connections with blank cut edges (> 10 poles) the voltage reduces to 25 V.

Screw connection with clamping-yoke technology (W-Series)
Accessories - Potential distribution

Continuous cross-connection

ZQV 2.5N

ZQV 4N

Universal range

A



Technical data	
current	A
Ordering data	
2-pin	
3-pin	
4-pin	
5-pin	
6-pin	
7-pin	
8-pin	
9-pin	
10-pin	
20-pin	
Note	

24			
Type	Qty.	Order No.	
ZQV 2.5N/2	60	1527540000	
ZQV 2.5N/3	60	1527570000	
ZQV 2.5N/4	60	1527590000	
ZQV 2.5N/5	20	1527620000	
ZQV 2.5N/6	20	1527630000	
ZQV 2.5N/7	20	1527640000	
ZQV 2.5N/8	20	1527670000	
ZQV 2.5N/9	20	1527680000	
ZQV 2.5N/10	20	1527690000	
ZQV 2.5N/20	20	1527720000	

32			
Type	Qty.	Order No.	
ZQV 4N/2	60	1527930000	
ZQV 4N/3	60	1527940000	
ZQV 4N/4	60	1527970000	
ZQV 4N/5	60	1527980000	
ZQV 4N/6	20	1527990000	
ZQV 4N/7	20	1528020000	
ZQV 4N/8	20	1528030000	
ZQV 4N/9	20	1528070000	
ZQV 4N/10	20	1528090000	



Technical data	
current	A
Ordering data	
2-pin	
3-pin	
4-pin	
5-pin	
6-pin	
7-pin	
8-pin	
9-pin	
10-pin	
20-pin	
Note	

24			
Type	Qty.	Order No.	
ZQV 2.5N/2 BL	60	1527740000	
ZQV 2.5N/3 BL	60	1527770000	
ZQV 2.5N/4 BL	60	1527780000	
ZQV 2.5N/5 BL	20	1527790000	
ZQV 2.5N/6 BL	20	1527820000	
ZQV 2.5N/7 BL	20	1527830000	
ZQV 2.5N/8 BL	20	1527840000	
ZQV 2.5N/9 BL	20	1527870000	
ZQV 2.5N/10 BL	20	1527880000	
ZQV 2.5N/20 BL	20	1527890000	

32			
Type	Qty.	Order No.	
ZQV 4N/2 BL	60	1528040000	
ZQV 4N/3 BL	60	1528080000	
ZQV 4N/4 BL	60	1528120000	
ZQV 4N/5 BL	60	1528140000	
ZQV 4N/6 BL	20	1528170000	
ZQV 4N/7 BL	20	1528180000	
ZQV 4N/8 BL	20	1528190000	
ZQV 4N/9 BL	20	1528220000	
ZQV 4N/10 BL	20	1528230000	



Technical data	
current	A
Ordering data	
2-pin	
3-pin	
4-pin	
5-pin	
6-pin	
7-pin	
8-pin	
9-pin	
10-pin	
20-pin	
Note	

24			
Type	Qty.	Order No.	
ZQV 2.5N/2 RD	60	2108470000	
ZQV 2.5N/3 RD	60	2108690000	
ZQV 2.5N/4 RD	60	2108700000	
ZQV 2.5N/5 RD	20	2108710000	
ZQV 2.5N/6 RD	20	2108720000	
ZQV 2.5N/7 RD	20	2108810000	
ZQV 2.5N/8 RD	20	2108870000	
ZQV 2.5N/9 RD	20	2108900000	
ZQV 2.5N/10 RD	20	2108910000	
ZQV 2.5N/20 RD	20	2108920000	

32			
Type	Qty.	Order No.	
ZQV 4N/2 RD	60	2460450000	
ZQV 4N/3 RD	60	2460810000	
ZQV 4N/4 RD	60	2460800000	
ZQV 4N/5 RD	60	2460790000	
ZQV 4N/6 RD	20	2460780000	
ZQV 4N/7 RD	20	2460770000	
ZQV 4N/8 RD	20	2460760000	
ZQV 4N/9 RD	20	2460750000	
ZQV 4N/10 RD	20	2460740000	



WQV screw-in cross-connection

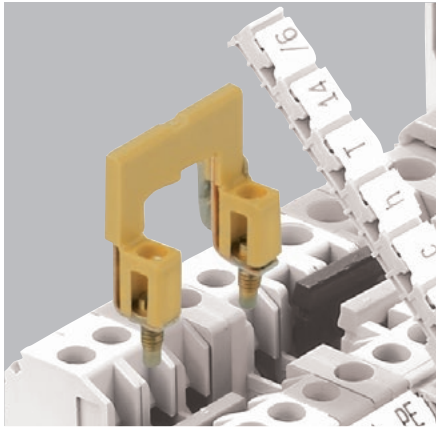

Any number of poles (extending)

Pre-fitted cross-connections can be set one after the other to produce any required number of poles. To do so, arrange the last and first contact points of two identical WQVs so that they overlap.

- First, remove the fixing screw and screwdriver guide (insulated part) at one of the outer contact points of one of the WQVs.

Thanks to the many possible ways in which the WQV cross-connection system can be used – break-out of individual layers, creation of any number of poles or running of two voltages parallel to one another – individual modules can be realised very easily!

Technical instructions

- The full rated current of the terminals can be routed across any number of poles.
- No end plates or partition plates needed for adjacent WQV up to 400 V.

Assembly

- Place the WQV in the cross-connection channel in the middle of the terminal and screw tight.
- Individual WQV segments can be broken out by bending over or using the WAW1 tool (9004500000). It is then possible to bridge individual or several terminals.

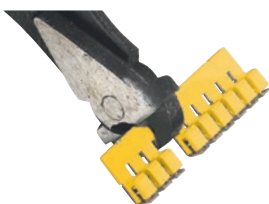

- Captive fixing screws.
- Snap onto the clamped support – simple overhead assembly.



- Then insert the WQV without fixing screw and insulated part. At the same time, insert an unmodified WQV in parallel so as to produce an overlap at the connection. The connection is screwed tight using the fixing screw of the unmodified WQV.

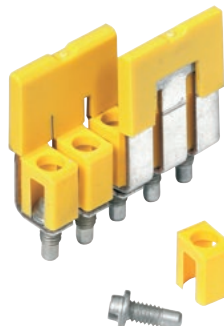

Routing 2 potentials in parallel

- In spite of only having 1 channel, the QV cross-connection system can still be used for offset cross-connections. See the photo “parallel bridging” (see on the next page).

WQV in combination with a socket contact and test plug

- Remove the fixing screw and insulation part of the WQV. Screw the socket in at this point. This now makes it possible to integrate a safe test point.

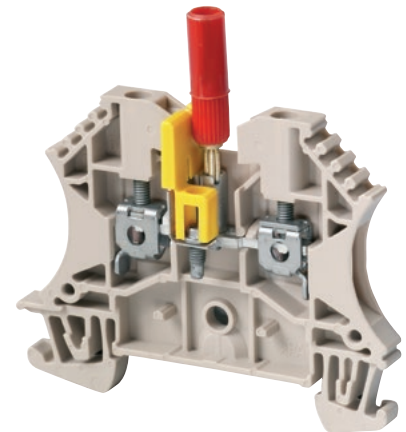

Potential distribution – possible combinations

In one cross-connection channel

single

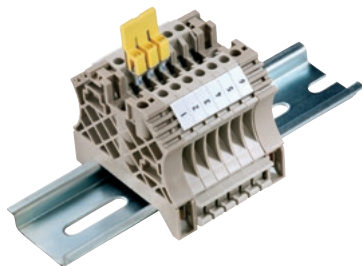

adjacent

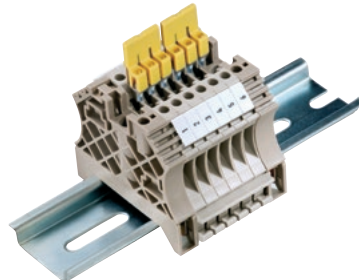

bridging

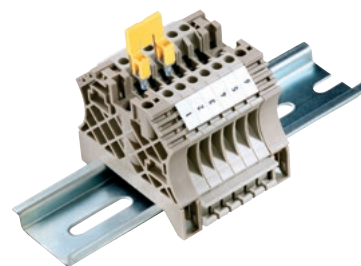

parallel/bridging

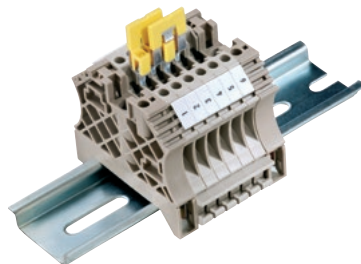

parallel/lengthening

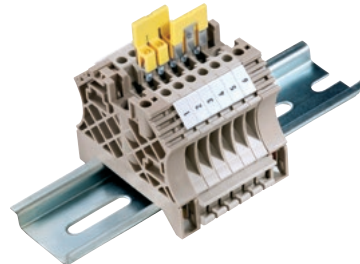

Possible cross-connections of terminals of the same type
with appropriate cross-connectors

Terminal type	Cross-connector	single	adjacent	bridging	parallel bridging	parallel lengthening
Standard						
WDU 1.5/ZZ	WQV 2.5	•	•	•	•	•
WDU 1.5/BLZ	WQV 2.5	•	•	•	•	•
WDU 2.5/1.5/ZR	WQV 2.5	•	•	•	•	•
WDU 2.5 - WDU 35	WQV 2.5 - WQV 35	•	•	•	•	•
WDK 2.5...	WQV 2.5	•	•	•	•	•
WDK 2.5 PE	WQV 2.5	•	•	•	•	•
WDU 2.5/BLZ	WQV 2.5	•	•	•	•	•
WDK 2.5/BLZ	WQV 2.5	•	•	•	•	•
WDU 2.5 F...	WQV 2.5	•	•	•	•	•
WDK 2.5 F...	WQV 2.5	•	•	•	•	•
WDU 4... - WDU 35...	WQV 4 - WQV 35	•	•	•	•	•
WDU 70/95	WQV 70/95	•	•	•	•	•
WDU 120/150	WQV 120/150	•	•	•	•	•
WDU 240	WQB 240	•	•	•	•	•
Compact						
WDU 2.5N	WQV 2.5	•	•	•	•	•
WDU 2.5N 600V	WQV 2.5	•	•	•	•	•
WDU 16N	WQV 16N	•	•	•	•	•
WDU 35N	WQV 35N	•	•	•	•	•
WDU 50N	WQV 50N	•	•	•	•	•
WDU 70N	WQV 70N	•	•	•	•	•
WDU 95N/120N	WQV 95N/120N	•	•	•	•	•



Screw connection with clamping-yoke technology (W-Series)
Accessories - Potential distribution

Universal range

A

WQV 2.5



Technical data	
current	A
Ordering data	
2-pin	
3-pin	
4-pin	
5-pin	
5-pin	
6-pin	
7-pin	
8-pin	
9-pin	
10-pin	
15-pin	
20-pin	
32-pin	
Note	

32			
Type	Qty.	Order No.	
WQV 2.5/2	50	1053660000	
WQV 2.5/3	50	1053760000	
WQV 2.5/4	50	1053860000	
WQV 2.5/5	10	1053960000	
WQV 2.5/6	10	1054060000	
WQV 2.5/7	10	1054160000	
WQV 2.5/8	10	1054260000	
WQV 2.5/9	10	1054360000	
WQV 2.5/10	20	1054460000	
WQV 2.5/15	10	1059660000	
WQV 2.5/20	10	1577570000	
WQV 2.5/32	10	1577600000	

WQV 4



41			
Type	Qty.	Order No.	
WQV 4/2	50	1051960000	
WQV 4/3	50	1054560000	
WQV 4/4	50	1054660000	
WQV 4/5	10	1057860000	
WQV 4/6	10	1057160000	
WQV 4/7	10	1057260000	
WQV 4/10	20	1052060000	

WQV 6



57			
Type	Qty.	Order No.	
WQV 6/2	50	1052360000	
WQV 6/3	50	1054760000	
WQV 6/4	50	1054860000	
WQV 6/5	50	1062660000	
WQV 6/6	50	1062670000	
WQV 6/7	50	1062680000	
WQV 6/10	20	1052260000	

WQV 35N



Technical data	
current	A
Ordering data	
2-pin	
3-pin	
4-pin	
5-pin	
5-pin	
6-pin	
7-pin	
8-pin	
9-pin	
10-pin	
15-pin	
20-pin	
32-pin	
Note	

125			
Type	Qty.	Order No.	
WQV 35N/2	20	1079200000	
WQV 35N/3	20	1079300000	
WQV 35N/4	20	1079400000	

WQV 50N



150			
Type	Qty.	Order No.	
WQV 50N/2	5	1834060000	
WQV 50N/3	5	1834070000	
WQV 50N/4	5	1834080000	
WQV 50N/5	5	2004960000	
WQV 50N/5/3/1	5	1469080000	

WQV 70N



192			
Type	Qty.	Order No.	
WQV 70N/2	5	9512240000	
WQV 70N/3	5	9512250000	
WQV 70N/4	5	9531290000	
WQV 70N/5	5	2004950000	
WQV 70N/5/3/1	5	1393020000	

WQV 10



57		
Type	Qty.	Order No.
WQV 10/2	50	1052560000
WQV 10/3	50	1054960000
WQV 10/4	50	1055060000
WQV 10/10	20	1052460000

WQV 16



101		
Type	Qty.	Order No.
WQV 16/2	50	1053260000
WQV 16/3	50	1055160000
WQV 16/4	50	1055260000
WQV 16/10	10	1053360000

WQV 16N



101		
Type	Qty.	Order No.
WQV 16N/2	50	1636560000
WQV 16N/3	50	1636570000
WQV 16N/4	50	1636580000

WQV 35



138		
Type	Qty.	Order No.
WQV 35/2	50	1053060000
WQV 35/3	50	1055360000
WQV 35/4	50	1055460000
WQV 35/10	10	1053160000

WQV 70/95



232		
Type	Qty.	Order No.
WQV 70/95/2	5	1063500000
WQV 70/95/3	5	1063600000

WQV 95N/120N



269		
Type	Qty.	Order No.
WQV 95N/120N/2	5	1826890000
WQV 95N/120N/3	5	1826900000
WQV 95N/120N/4	5	1826910000
WQV 95N/120N/5/3/1	5	1469090000

WQV 120



269		
Type	Qty.	Order No.
WQV 120/2	5	1063300000
WQV 120/3	5	1063400000



Screw connection with clamping-yoke technology (W-Series)
Accessories - Potential distribution

Universal range

A

Screwable QV

Q AKZ 4 SS



Technical data	
current	A
Ordering data	
2-pin	
3-pin	
4-pin	
10-pin	
20-pin	
Note	

20		
Type	Qty.	Order No.
Q 2 AKZ4SS	50	0369000000
Q 10 AKZ4SS	20	0369300000
Note		

Q / DLI



20		
Type	Qty.	Order No.
Q 2 DLI	50	1312500000
Q 3 DLI	50	1312600000
Q 4 DLI	50	1312700000
Q 10 DLI	20	1313100000
Q 20 DLI	20	1399800000
Note		

Q AKZ 1.5



24		
Type	Qty.	Order No.
Q 2 AKZ1.5	50	0368200000
Q 3 AKZ1.5	50	0368300000
Q 4 AKZ1.5	50	0368400000
Q 10 AKZ1.5	20	0368500000
Note		

Screwable QV

Q AKZ 4



Technical data	
current	A
Ordering data	
2-pin	
3-pin	
4-pin	
10-pin	
20-pin	
Note	

32		
Type	Qty.	Order No.
Q 2 AKZ4	50	0336400000
Q 3 AKZ4	50	0336500000
Q 4 AKZ4	50	0336600000
Q 10 AKZ4	20	0368600000
Note		

Q / WDL



24		
Type	Qty.	Order No.
Q 2 WDL2.5S	50	1071500000
Q 3 WDL2.5S	50	1071600000
Q 4 WDL2.5S	50	1071700000
Q 10 WDL2.5S	20	1071800000
Q 20 WDL2.5S	20	1074200000
Note		

Potential supply with cross-section reduction

Feed-in via output terminal

WDU 35

onto WDU 10



Technical data	
Rated current	A
Internal thread	-
Tightening torque	-
Ordering data	
2-pin	
3-pin	
Note	

to WDU 35		to WDU 10	
57			
0.6...1.2			
Type	Qty.	Order No.	
WQV 35-10	10	1068000000	
Note			

WDU 35

onto WDU 2.5



to WDU 35		to WDU 10	
41			
0.4...0.8			
Type	Qty.	Order No.	
WQV 35-2.5	10	1064100000	
Note			

WQV 70N-35



to		
Type	Qty.	Order No.
WQV 70N-35	5	2462540000
Note		



Feed-in via output terminal

WDU 16

WDU 2.5



to WDU 16	to WDU 2.5
76	

Type	Qty.	Order No.
WQV 16-2.5	10	1063900000

Technical data	
Rated current	A
Internal thread	-
Tightening torque	-
Ordering data	
	2-pin
	3-pin
Note	

WDU 16N

WDU 2.5



to WDU 16	to WDU 2.5

Type	Qty.	Order No.
WQV 16N-2.5	10	1073100000

WDU 16N

WDU 4 / WDU 6



to WDU 16N	to WDU 4 / 6
57	

Type	Qty.	Order No.
WQV 16N-4/6	10	1072500000

Feed-in via output terminal

WDU 10

WDU 2.5



to WDU 10	to WDU 2.5

Type	Qty.	Order No.
Q WDU10-2.5 SET	10	1859620000

Technical data	
Rated current	-
Internal thread	-
Tightening torque	-
Ordering data	
	2-pin
	3-pin
Note	

WDU 6

WDU 2.5



to WDU 6	to WDU 2.5

Type	Qty.	Order No.
Q WDU6-2.5 SET	10	1859600000

Note

Cross-connectors reducing the cross-section may not be used in ATEX applications.

Feed-in via output terminal

WDU 10

WDU 4



to WDU 10	to WDU 4

Type	Qty.	Order No.
Q WDU 10-4 SET	10	1859610000

Technical data	
Rated current	A
Internal thread	-
Tightening torque	-
Ordering data	
	2-pin
Note	

WDU 35

WDU 4 / WDU 6



to WDU 35	to WDU 4 / 6

Type	Qty.	Order No.
WQV 35-4/6	10	1064200000

WDU 16

WDU 4 / WDU 6



to WDU 16	to WDU 4 / 6

Type	Qty.	Order No.
WQV 16-4/6	10	1064000000

Screw connection with clamping-yoke technology (W-Series)
Accessories - Testing / checking

Universal range

A

Test adapter

WTA 1



WTA 2



WTA 3



Dimensions	
Width / Length / Height	mm
Stripping length	mm
Rated data	
Rated voltage	V
Rated current	A
for wire cross-section	mm ²
Clamped conductors (H05V/H07V)	
Solid / Stranded	mm ²
Flexible / Flexible with ferrule	mm ²
Ordering data	
	1-pin
	with snap-in pegs
	10-pin
Note	

5 / / 66.1			
6			
IEC	UL	CSA	
250	0		
6	0		
1.5	LEER		
Type	Qty.	Order No.	
WTA 1 WDU1.5	25	1632290000	
WTA 1/ZA WDU1.5	25	1632300000	

5 / / 66.1			
6			
IEC	UL	CSA	
250	0		
6	0		
1.5	LEER		
Type	Qty.	Order No.	
WTA 2 WDU2.5-10	25	1632320000	
WTA 2/ZA WDU2.5-10	25	1632330000	
WTA 2/10 WDU2.5/10	5	1632340000	

6 / / 66.1			
6			
IEC	UL	CSA	
250	0		
6	0		
1.5	LEER		
Type	Qty.	Order No.	
WTA 3 WDU4	25	1632350000	
WTA 3/ZA WDU4	25	1632360000	

Test adapter

WTA 6



WTA 7



Dimensions	
Width / Length / Height	mm
Stripping length	mm
Rated data	
Rated voltage	V
Rated current	A
for wire cross-section	mm ²
Clamped conductors (H05V/H07V)	
Solid / Stranded	mm ²
Flexible / Flexible with ferrule	mm ²
Ordering data	
	1-pin
	with snap-in pegs
	10-pin
Note	

5 / / 66.1			
6			
IEC	UL	CSA	
250	0		
6	0		
1.5	LEER		
Type	Qty.	Order No.	
WTA 6 WTR2.5	25	1632380000	
WTA 6/ZA WTR2.5	25	1632390000	

6 / / 68.15			
6			
IEC	UL	CSA	
250	0		
6	0		
1.5	LEER		
Type	Qty.	Order No.	
WTA 7 WSI6	25	1650210000	

WTA 4N



5 / 55		
6		
IEC	UL	CSA
250	0	
6	0	
1.5	LEER	
0.5...1.5		
1...1.5 / 0.5...1.5		
Type	Qty.	Order No.
WTA 4N WDK 2.5	25	1878660000
WTA 4N/ZA WDK 2.5	25	1879350000

WTA 5



5 / 17		
8		
IEC	UL	CSA
250	0	
6	0	
0.75	LEER	
0.5...1		
1...1 / 0.5...1		
Type	Qty.	Order No.
WTA 5/1	25	1051260000
WTA 5/10	5	1062060000

Test adapter

Dimensions	
Width / Length / Height	mm
Stripping length	-
Rated data	
Rated voltage	V
Rated current	A
for wire cross-section	mm ²
Clamped conductors (H05V/H07V)	
Solid / Stranded	mm ²
Flexible / Flexible with ferrule	-
Ordering data	
	beige
	green
Note	

WTA 8



6 / 39		
IEC	UL	CSA
205	0	
6	0	
1.5	LEER	
0.5...2.5		
Type	Qty.	Order No.
WTA 8 TN	25	1915450000
WTA 8 KO-TN	25	1915480000



SIHA fuse holder

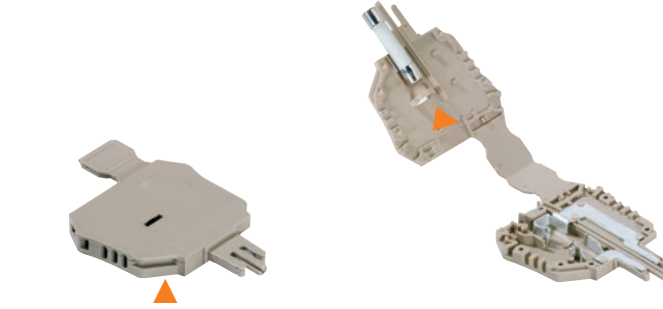
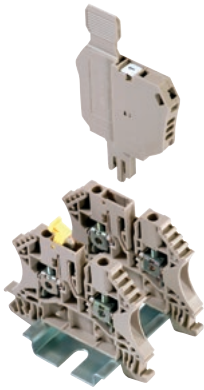

1. Open fuse holder with fingers or screwdriver



2. Press out old fuse

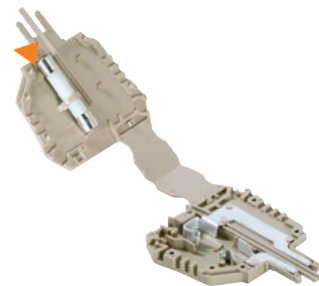

3. Position new fuse



4. Press fuse holder together again

For 5x20 G-fuse cartridges

The SIHA fuse holder turns a test disconnect terminal into a fuse terminal in seconds: Simply remove the isolating lever and insert the fuse plug

- Simple handling – no tools required
- Housing made of Wemid (VO)
- Rated current 6.3 A
- 1.6 W power loss to DIN VDE 0611-6 at 23 °C ambient temperature (also for 1.5 times rated current – composite arrangement)
- Even fits on 5 mm wide terminals when fitted in offset arrangement
- Marking position for Dekafix 5 and space for self-adhesive label size 8/20

SIHA 1



without LED		Qty.	Order No.
SIHA1/G20	400 V	1	9537550000
with LED (rot)			
SIHA1/G20	10 - 36 V	1	9537560000

SIHA 3



without LED		Qty.	Order No.
SIHA3/G20	400 V	1	7921560000
with LED (rot)			
SIHA3/G20	10 - 36 V	1	7921570000
	35 - 70 V	1	7921580000
	60 - 150 V	1	7921590000
	140 - 250 V	1	7921600000

SIHA STRAP

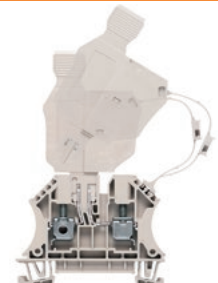

with strap		Qty.	Order No.
SIHA STRAP		20	9537680000



For test-disconnect terminal versions	
WTR 2.5/ZZ	

For test-disconnect terminal versions	
WTR 4	
WTR 4/ZZ	
WTR 4/ZR	
WTR 2,5	

Connector for "retro-fit" assembly	
• Receptacle in the terminal is the marking position	
• Integrated marking position on the strap	
• Slots into fuse holder either left or right	

PEN bridges

Energy distribution for machines or in buildings usually consists of 5-conductor systems (TN-S). By contrast, energy supply mains are frequently rated as 4-conductor connection. A PEN bridge joins separate PE and N conductors into one PEN conductor, creating the transition from a TN-S to a TN-C system.

Standard installation

Depending on the terminal type, inside or outside, PEN bridges are available for both PE and N conductor terminals from 10 mm². **Important!** For outside bridges, please note that in this context only the next smaller rated cross-section (than standard) can be connected.

Building installation with N-conductor isolation

Special external cross-connections (WQB-PEN) are available for neutral conductor test-disconnect terminals (WNT). These establish contact between the NT and PE terminals. This results in an earthed neutral conductor with protection function in three-phase systems.

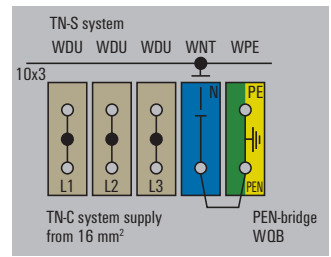

External PEN bridge



Inside PEN bridge

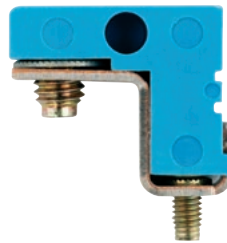

WQB-PEN ...

Type	Qty	Order No.	For terminal
with standard terminals			
WQB-PEN 10	10	1060300000	WPE 10 WDU 10 BL
WQB-PEN 16	10	1060200000	WPE 16 WDU 16 BL
WQB-PEN 35	10	1060100000	WPE 35 WDU 35 BL
with compact terminals			
WQB-PEN 16N	10	1079600000	WNT 16N WPE 16N
WQB-PEN 35N	10	1079500000	WNT 35N WPE 35N
WQB-PEN 70N	10	1079700000	WNT 70N WPE 70N

WQV ... -PEN

Typ	Qty	Order No.	For terminal
WQV 16N-PEN	10	1071360000	WPE 16N WDU 16N BL
WQV 70N-PEN	5	9525840000	WPE 70N WDU 70N BL
WQV 70/95-PEN	5	1072300000	WPE 70/95 WDU 70/95 BL
WQV 120-PEN	5	1072400000	WPE 120/150 WDU 120/150 BL
WQV 50N-PEN		9201610000	WPE 50N WDU 50N
WQV 95N/120N-PEN		9201630000	WPE 95N/120N WDU 95N/120N

TN-S system:

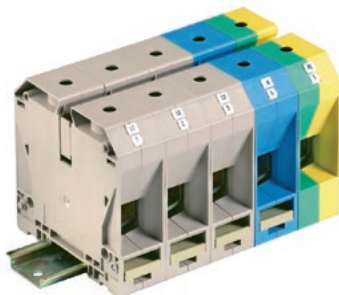
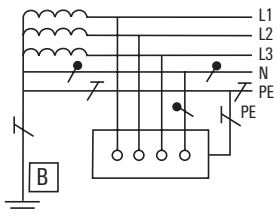

TN-C system:

